

2D Code Reader

V530-R160E/V530-R160EP

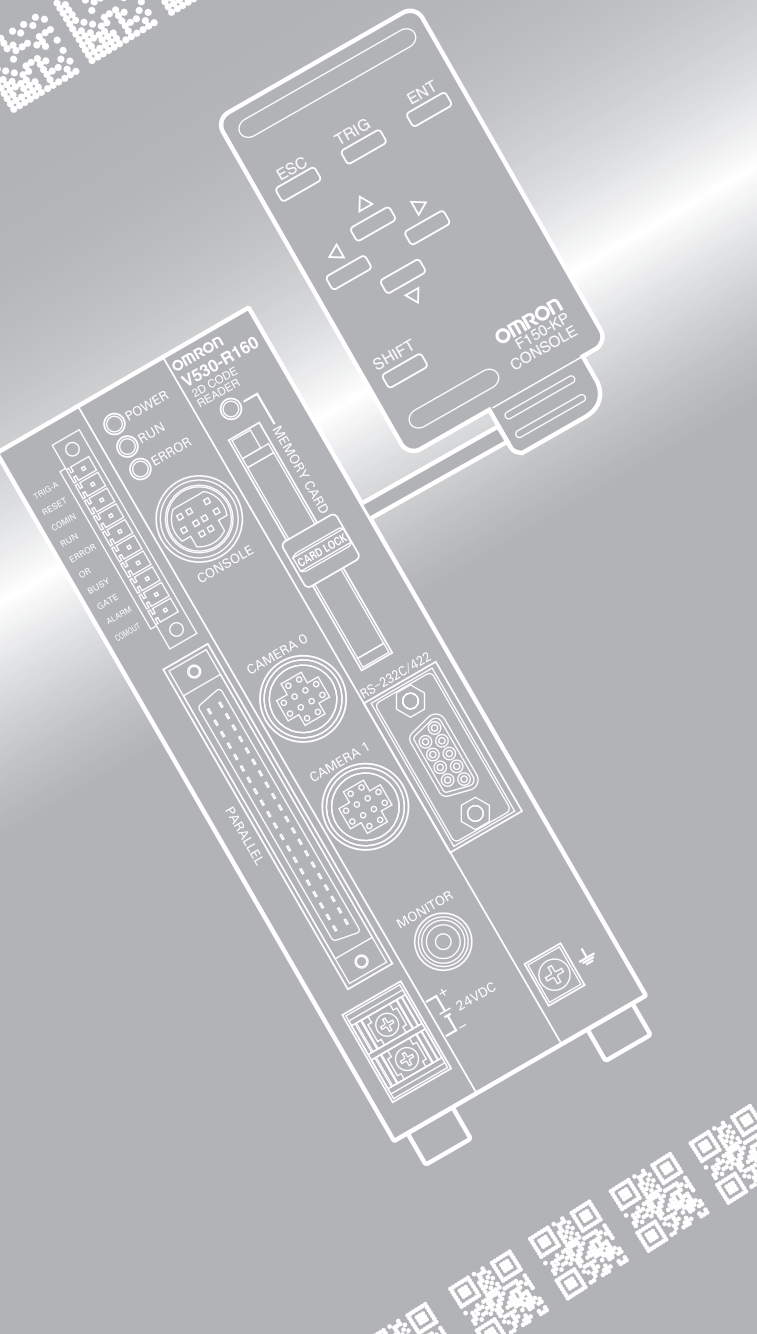

USER'S MANUAL

Product Availability

Some of the products listed may not be available in some countries. Please contact your nearest OMRON sales office by referring to the addresses provided at the back of this manual.

© OMRON, 2002

All rights reserved. No part of this publication may be reproduced, stored in a retrieval system, or transmitted, in any form, or by any means, mechanical, electronic, photocopying, recording, or otherwise, without the prior written permission of OMRON.

No patent liability is assumed with respect to the use of the information contained herein. Moreover, because OMRON is constantly striving to improve its high-quality products, the information contained in this manual is subject to change without notice. Every precaution has been taken in the preparation of this manual. Nevertheless, OMRON assumes no responsibility for errors or omissions. Neither is any liability assumed for damages resulting from the use of the information contained in this publication.

Trademarks

Compact Flash is a registered trademark of SanDisk Corporation.

INTRODUCTION	APPLICATION CONSIDERATIONS/Precautions for Safe Use	INTRODUCTION
SECTION 1	Outline	SECTION 1
SECTION 2	Installation and Connections	SECTION 2
SECTION 3	Connection to the Host	SECTION 3
SECTION 4	Basic Operations	SECTION 4
SECTION 5	Setting Reading Conditions	SECTION 5
SECTION 6	Other Functions	SECTION 6
SECTION 7	System Settings	SECTION 7
SECTION 8	Communication with the Host	SECTION 8
SECTION 9	Troubleshooting	SECTION 9
SECTION 10	Appendix	SECTION 10

V530-R160E/V530-R160EP

2D Code Reader

User's Manual

APPLICATION CONSIDERATIONS

READ AND UNDERSTAND THIS DOCUMENT

Please read and understand this document before using the products. Please consult your OMRON representative if you have any questions or comments.

WARRANTY

OMRON's exclusive warranty is that the products are free from defects in materials and workmanship for a period of one year (or other period if specified) from date of sale by OMRON.

OMRON MAKES NO WARRANTY OR REPRESENTATION, EXPRESS OR IMPLIED, REGARDING NON-INFRINGEMENT, MERCHANTABILITY, OR FITNESS FOR PARTICULAR PURPOSE OF THE PRODUCTS. ANY BUYER OR USER ACKNOWLEDGES THAT THE BUYER OR USER ALONE HAS DETERMINED THAT THE PRODUCTS WILL SUITABLY MEET THE REQUIREMENTS OF THEIR INTENDED USE. OMRON DISCLAIMS ALL OTHER WARRANTIES, EXPRESS OR IMPLIED.

LIMITATIONS OF LIABILITY

OMRON SHALL NOT BE RESPONSIBLE FOR SPECIAL, INDIRECT, OR CONSEQUENTIAL DAMAGES, LOSS OF PROFITS OR COMMERCIAL LOSS IN ANY WAY CONNECTED WITH THE PRODUCTS, WHETHER SUCH CLAIM IS BASED ON CONTRACT, WARRANTY, NEGLIGENCE, OR STRICT LIABILITY.

In no event shall responsibility of OMRON for any act exceed the individual price of the product on which liability is asserted.

IN NO EVENT SHALL OMRON BE RESPONSIBLE FOR WARRANTY, REPAIR, OR OTHER CLAIMS REGARDING THE PRODUCTS UNLESS OMRON'S ANALYSIS CONFIRMS THAT THE PRODUCTS WERE PROPERLY HANDLED, STORED, INSTALLED, AND MAINTAINED AND NOT SUBJECT TO CONTAMINATION, ABUSE, MISUSE, OR INAPPROPRIATE MODIFICATION OR REPAIR.

SUITABILITY FOR USE

THE PRODUCTS CONTAINED IN THIS DOCUMENT ARE NOT SAFETY RATED. THEY ARE NOT DESIGNED OR RATED FOR ENSURING SAFETY OF PERSONS, AND SHOULD NOT BE RELIED UPON AS A SAFETY COMPONENT OR PROTECTIVE DEVICE FOR SUCH PURPOSES. Please refer to separate catalogs for OMRON's safety rated products.

OMRON shall not be responsible for conformity with any standards, codes, or regulations that apply to the combination of products in the customer's application or use of the product.

At the customer's request, OMRON will provide applicable third party certification documents identifying ratings and limitations of use that apply to the products. This information by itself is not sufficient for a complete determination of the suitability of the products in combination with the end product, machine, system, or other application or use.

The following are some examples of applications for which particular attention must be given. This is not intended to be an exhaustive list of all possible uses of the products, nor is it intended to imply that the uses listed may be suitable for the products:

- Outdoor use, uses involving potential chemical contamination or electrical interference, or conditions or uses not described in this document.
- Nuclear energy control systems, combustion systems, railroad systems, aviation systems, medical equipment, amusement machines, vehicles, safety equipment, and installations subject to separate industry or government regulations.
- Systems, machines, and equipment that could present a risk to life or property.

Please know and observe all prohibitions of use applicable to the products.

NEVER USE THE PRODUCTS FOR AN APPLICATION INVOLVING SERIOUS RISK TO LIFE OR PROPERTY WITHOUT ENSURING THAT THE SYSTEM AS A WHOLE HAS BEEN DESIGNED TO ADDRESS THE RISKS, AND THAT THE OMRON PRODUCT IS PROPERLY RATED AND INSTALLED FOR THE INTENDED USE WITHIN THE OVERALL EQUIPMENT OR SYSTEM.

PERFORMANCE DATA

Performance data given in this document is provided as a guide for the user in determining suitability and does not constitute a warranty. It may represent the result of OMRON's test conditions, and the users must correlate it to actual application requirements. Actual performance is subject to the OMRON Warranty and Limitations of Liability.

CHANGE IN SPECIFICATIONS

Product specifications and accessories may be changed at any time based on improvements and other reasons.

It is our practice to change model numbers when published ratings or features are changed, or when significant construction changes are made. However, some specifications of the product may be changed without any notice. When in doubt, special model numbers may be assigned to fix or establish key specifications for your application on your request. Please consult with your OMRON representative at any time to confirm actual specifications of purchased products.

DIMENSIONS AND WEIGHTS

Dimensions and weights are nominal and are not to be used for manufacturing purposes, even when tolerances are shown.

ERRORS AND OMISSIONS

The information in this document has been carefully checked and is believed to be accurate; however, no responsibility is assumed for clerical, typographical, or proofreading errors, or omissions.

PROGRAMMABLE PRODUCTS

OMRON shall not be responsible for the user's programming of a programmable product, or any consequence thereof.

COPYRIGHT AND COPY PERMISSION

This document shall not be copied for sales or promotions without permission.

This document is protected by copyright and is intended solely for use in conjunction with the product. Please notify us before copying or reproducing this document in any manner, for any other purpose. If copying or transmitting this document to another, please copy or transmit it in its entirety.

PRECAUTIONS ON SAFETY

- Meanings of Signal Words

The following signal words are used in this manual.



WARNING

Indicates a potentially hazardous situation which, if not avoided, will result in minor or moderate injury, or may result in serious injury or death. Additionally there may be significant property damage.

- Meanings of Alert Symbols

The following alert symbols are used in this document.



Indicates the possibility of explosion under specific conditions.







WARNING

Failure to read and understand the information provided in this manual may result in personal injury or death, damage to the product, or product failure. Please read each section in its entirety and be sure you understand the information provided in the section and related sections before attempting any of the procedures or operations given.

- Alert statements in this Manual

The following alert statements apply to the products in this manual. Each alert statement also appears at the locations needed in this manual to attract your attention.

 WARNING	
<p>This product is not designed or rated for ensuring safety of persons. Do not use it for such purposes.</p>	
<p>A lithium battery is built into the V530-R160E/EP and may occasionally combust, explode, or burn if not treated properly. Dispose of the Controller as industrial waste, and never disassemble, apply pressure that would deform, heat to 100 °C or higher, or incinerate the V530-R160E/EP.</p>	
<p>A lithium battery is built into the V530-R160E/EP and may occasionally combust, explode, or burn if not treated properly. When replacing the battery, never short-circuit, attempt to charge, disassemble, apply pressure that would deform, or incinerate the battery.</p>	

Precautions for Safe Use

Observe the following precautions to ensure safe use of the product.

■ Installation Environment Precautions

- Do not use the V530-R160E/EP in environments with flammable or explosive gases.
- Do not block the V530-R160E/EP's cooling vents.

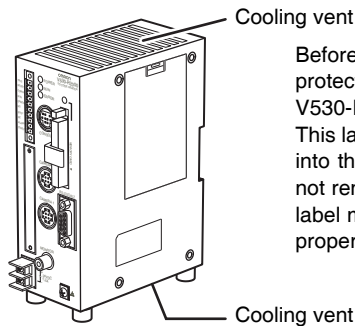

Before the V530-R160E/EP is shipped, a protective label is attached to the top of the V530-R160E/EP to cover the cooling vent. This label prevents wire strands from falling into the V530-R160E/EP during wiring. Do not remove it until wiring is completed. The label must be removed after wiring to allow proper cooling during operation.

- Install the V530-R160E/EP away from high-voltage devices and moving machinery to allow safe access during operation and maintenance.
- Be sure to securely tighten the screws when mounting the V530-R160E/EP.

■ Power Supply and Wiring Precautions

- Use the V530-R160E/EP with the power supply voltages specified in this manual.
- Use the wire and crimp terminals of the proper sizes as specified in this manual. Do not connect the power supply wires by just twisting stranded wires and connecting them directly to the terminals.
- Keep the power supply cable as short as possible (10 m maximum).
- Use a DC power supply with countermeasures against high-voltage spikes (safe extra low-voltage circuits on the secondary side).

 p.45

- Use an appropriate ground (100 Ω maximum).
- Use a grounding point as close as possible to the V530-R160E/EP and keep the ground line as short as possible.
- Wire the V530-R160E/EP to the ground with a separate ground wire. To avoid grounding problems, do not share the ground wiring with any other devices or ground the V530-R160E/EP to the building's steel framing or plumbing.

 p.44

■ Connectors

Do not remove the connector cover. Doing so may cause product failure.

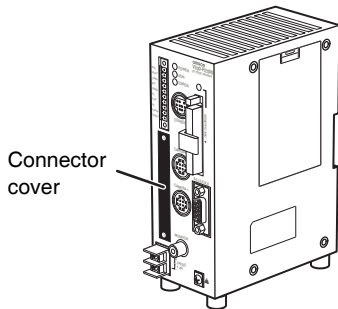

■ Regulations and Standards

- EN61326-1
- Electromagnetic environment : Industrial electromagnetic environment (EN/IEC 61326-1 Table 2)
- The following condition is applied to the immunity test of this product.
 - a) If the level of disturbance of the video is such that characters on the monitor are readable, the test is a pass.
 - b) Power line: 10 m max.
 - c) Signal line: 30 m max.
- Notice for Korea Radio Law

A 급 기기 (업무용 방송통신기자재)
 이 기기는 업무용 (A 급) 전자파적합기기로서 판매자
 또는 사용자는 이 점을 주의하시기 바라며 , 가정외의
 지역에서 사용하는 것을 목적으로 합니다.

■ Other Precautions

- Do not attempt to disassemble, repair, or modify the V530-R160E/EP. Doing so may cause product failure or a fire.
- If you suspect an error or malfunction, stop using the V530-R160E/EP immediately, turn OFF the power supply, and consult your OMRON representative.

Precautions for Correct Use

Observe the following precautions to prevent failure of the product to operate, product malfunctions, and adverse influences on performance and devices.

Controller Installation Site

- Do NOT install the V530-R160 in locations subject to the following conditions:

- Ambient temperatures outside of 0 to +50°C (32 to 122°F) range
- Rapid temperature fluctuations (likely to cause condensation)
- Relative humidities outside of the 35 to 85% range
- Presence of corrosive or flammable gases
- Presence of dust, salt, or iron particles
- Direct vibration or shock
- Direct sunlight
- Water, oil, or chemical fumes or spray

- **Mounting Orientation**

To improve heat dissipation, install the controller in the following orientation only:

Correct

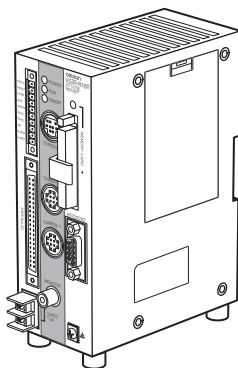

Do not install the controller in the orientations shown in the following diagram.

Incorrect

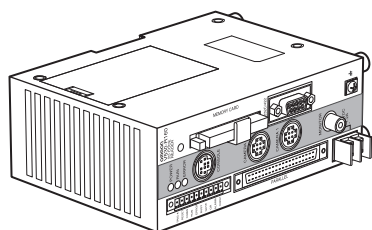

Incorrect

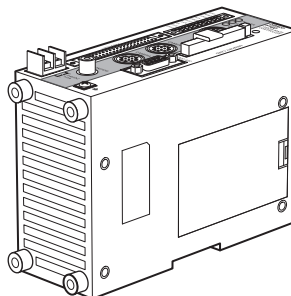

■ Ambient Temperature

- Maintain a minimum clearance of 50 mm above and below the V530-R160 to improve air circulation.
- Do not install the V530-R160 immediately above significant heat sources, such as heaters, transformers, or large-capacity resistors.
- Do not let the ambient operating temperature exceed 50°C (122°F).
- Provide a forced-air fan or air conditioning if the ambient temperature is near 50°C (122°F) so that the ambient temperature never exceeds 50°C (122°F).

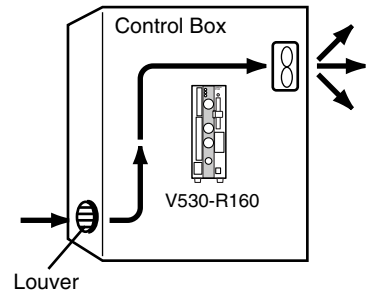

■ Noise Resistance

- Do not install the V530-R160 in a cabinet containing high-voltage equipment.
- Do not install the V530-R160 within 200 mm of power cables.

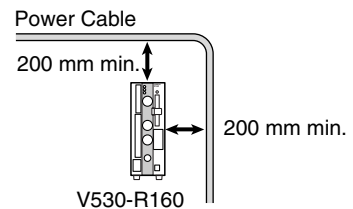

Component Installation and Handling

■ OMRON Components

Be sure to use the Camera, Camera Cable, and Console designed for the V530-R160.

 Refer to page 36.

■ Cameras and Cables

Always turn OFF the power before connecting or disconnecting cameras or cables.

■ Cameras

The camera's case is connected to the 0 V line in the internal circuits. Heed the following precautions to prevent noise interference.

- Do not ground the Camera.
- Do not remove the base attached to the Camera.
- Do not remove the core attached to the V530-VS-2D Camera Cable.

■ Touching Signal Lines

To prevent damage from static electricity, use a wrist strap or another device for preventing electrostatic discharges when touching terminals or signal lines in connectors.

■ Removing the Memory Card

Before removing a Memory Card, stop the power supply to the Card or turn OFF the V530-R160. The Memory Card or the V530-R160 itself may be damaged if a Memory Card is removed while power is being supplied.

(Stop the power supply to the Memory Card from the menu.  Refer to page 172.)

■ Turning OFF the Power

Do not turn OFF the power while a message is being displayed indicating that processing is being performed. Data in memory will be destroyed, and the V530-R160 may not operate correctly the next time it is started.

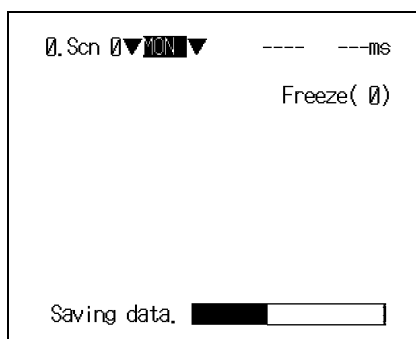

■ Using the RESET Signal

Do not use the RESET input immediately after power is turned ON. When using RESET input to synchronize execution timing, wait at least 1 second after turning ON the V530-R160 power supply before turning ON the RESET signal.

Confirming Package Contents

Check the contents of the package as soon as you receive the V530-R160.
Contact the nearest OMRON representative if any of the following items are missing.

- V530-R160 2-Dimensional Code Reader Controller

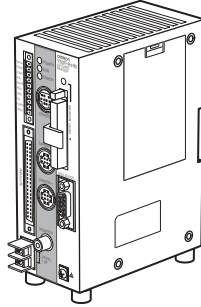

- Mounting Bracket (for rear surface mounting)

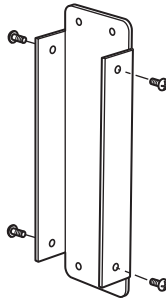

Bracket: Qty: 1
Screws (M3×6): Qty: 4

- Connector for I/O Terminals: Qty: 1
(Phoenix Contact model MC1.5/10-STF-3.5)

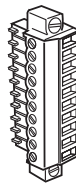

- Ferrite Core for F150-VM-2D Monitor Cable: Qty: 1

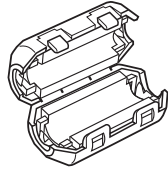

- User's Manual (this manual)

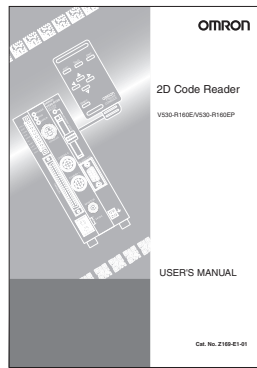

Editor's Note

Visual Aids

The following headings appear in the left column of the manual to help you locate different types of information.



Indicates information required to take full advantage of the functions and performance of the product. Incorrect application methods may result in the loss of damage or damage to the product. Read and follow all precautionary information.



CHECK!

Indicates points that are important in using product functions or in application procedures.



Indicates where to find related information.



Indicates information helpful in operation.

MEMO

Table of Contents

Introduction	1
APPLICATION CONSIDERATIONS	2
PRECAUTIONS ON SAFETY	5
Precautions for Safe Use	6
Precautions for Correct Use	8
Controller Installation Site	8
Component Installation and Handling	10
Confirming Package Contents	12
Editor's Note	14
Visual Aids	14
Table of Contents	16
Searching from the Menu Tree	22
SECTION 1 Outline	25
What is a 2-dimensional Code Reader?	26
Introduction to Functions	28
Operational Flow	32
SECTION 2 Installation and Connections	35
Basic System Configuration	36
Component Names and Functions	38
Mounting the Controller	39
DIN Track Mounting	39
Rear Surface-mounting	40
Side Surface-mounting	41
Bottom Surface-mounting	42
Connecting Peripheral Devices	43
Connecting a Console	43
Connecting a Monitor	43

Connecting a Camera	43
Power Supply and Ground	44
Crimp Terminals and Cables	44
Ground Wiring	44
Wiring the Power Supply	45
Cameras, Lenses, Lighting, and Memory Cards	46
Overview of Available Cameras	46
CCTV Lenses	47
Lighting	49
Memory Card	51
SECTION 3 Connection to the Host	53
Connecting through the Parallel I/O	54
I/O Terminal Connections	54
I/O Connector Connections	56
Internal Specifications	58
Connecting through the Serial Interface	60
Connector	61
Connection Examples	62
Connection	66
SECTION 4 Basic Operations	67
Starting the Controller	68
Basic Knowledge of Operations	70
Input Devices	70
Screen Displays	71
Changing Options	73
Inputting Values	74
Inputting Characters	75
Understanding Setting Operations	76
Select the Code and Capture the Image	76
Set Reading Conditions	79

Entering the SET Mode	79
Selecting Shutter Speed	80
Registering Models of Finder Pattern	81
Perform Tests	87
Start Reading	88
Save Settings and Exit the V530-R160	90

SECTION 5 Setting Reading Conditions 91

Adjusting the Image (Image Adjust)	92
Switching Cameras	92
Shutter Speed	93
Filtering	94
Filtering Retry	96
BGS Levels	98
Light Control	100
Setting Reading Conditions (DataMatrix)	104
Pattern Settings	104
Reading Settings	112
Display Settings	114
Trend Monitor Settings	119
Setting Reading Conditions (QRCode)	129
Pattern Settings	129
Reading Settings	141
Display Settings	141
Trend Monitor Settings	141

SECTION 6 Other Functions 143

Changing Scenes (Scene Function)	144
Setting Reading Conditions for Different Codes (Changing Scenes)	144
Copying Reading Conditions	146
Initializing Reading Conditions (Clearing Scenes)	147
Adding Comments to Scenes	148

Backing Up Data	149
Backing Up to Flash Memory	150
Backing Up Data to a Computer	151
Backing Up Data to a Memory Card	158
Memory Card Operations	163
Creating Directories	163
Copying Files	166
Checking File Properties	168
Changing File Names	169
Deleting Files and Directories	171
Turning OFF the Power Supply to the Memory Card	172
Checking I/O Status with Host Devices (I/O Monitor)	173
Serial Interface	173
Parallel I/O Interface	176
SECTION 7 System Settings	179
Entering System Mode	180
Settings Relating to the Camera and Monitor (Camera/Monitor)	181
Selecting the Conditions for Image Storage (Image Storing)	182
Setting Startup Conditions (Startup Mode)	186
Using BUSY Signals (Error Method)	187
Setting the Calendar Date and Time (Date/Time)	188
Checking the Version (Version)	189
SECTION 8 Communication with the Host	191
Parallel I/O	192
Setting Communications Specifications	192
Trigger Input and Output Formats	194
Timing Charts	195
System Examination	200
Serial Interface (Normal)	202
Flow Charts	203
Setting Communications Specifications	206

Command List	212
I/O Format	214
Command Format	216
Connection Examples for Programmable Controller (Normal)	229
Serial Interface (Host Link)	232
Flow Charts	233
Setting Communications Specifications	236
I/O Format	240
Connection Examples for Programmable Controller (Host Link)	244

SECTION 9 Troubleshooting 249

Improving Reading	250
Environment and Setup	250
Conditions Settings	251
Countermeasure Examples	252
Error Codes and Countermeasures	253
Error Messages and Corresponding Corrective Actions	257
Troubleshooting	261

SECTION 10 Appendix 263

Maintenance	264
Maintaining and Changing a Camera with a Light	264
Replacing the Battery	266
Regular Inspections	267
Specifications and Dimensions	268
Controller	268
V530-R160	268
Camera	269
F150-S1A-2D	269
Camera with an Intelligent Lighting	269
F150-SLC20	269
Camera Specifications	270

Console	271
F150-KP-2D	271
Camera Cable (For F150-S1A-2D Camera)	272
F150-VS-2D	272
Monitor Cable	273
F150-VM-2D	273
Parallel I/O Cable	274
F160-VP	274
LCD Color Monitor	275
F150-M05L-2D	275
Memory Card	276
F160-N64S(S)	276
QM300-N128S	276
ASCII Codes	277
FCS Check Program Examples (BASIC)	278
Data Capacity Tables	279
Glossary	283
Index	287
Revision History	289

Searching from the Menu Tree

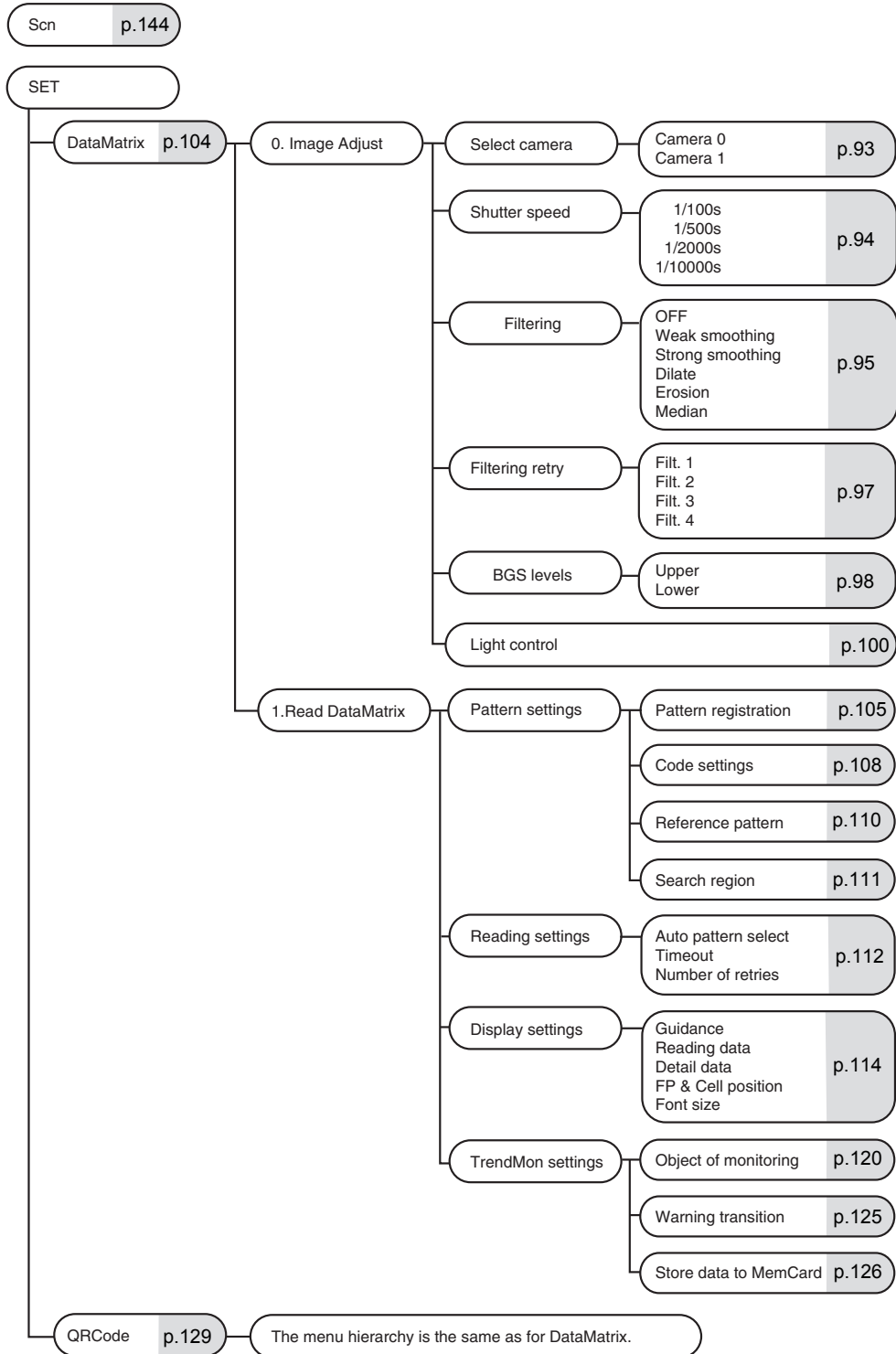

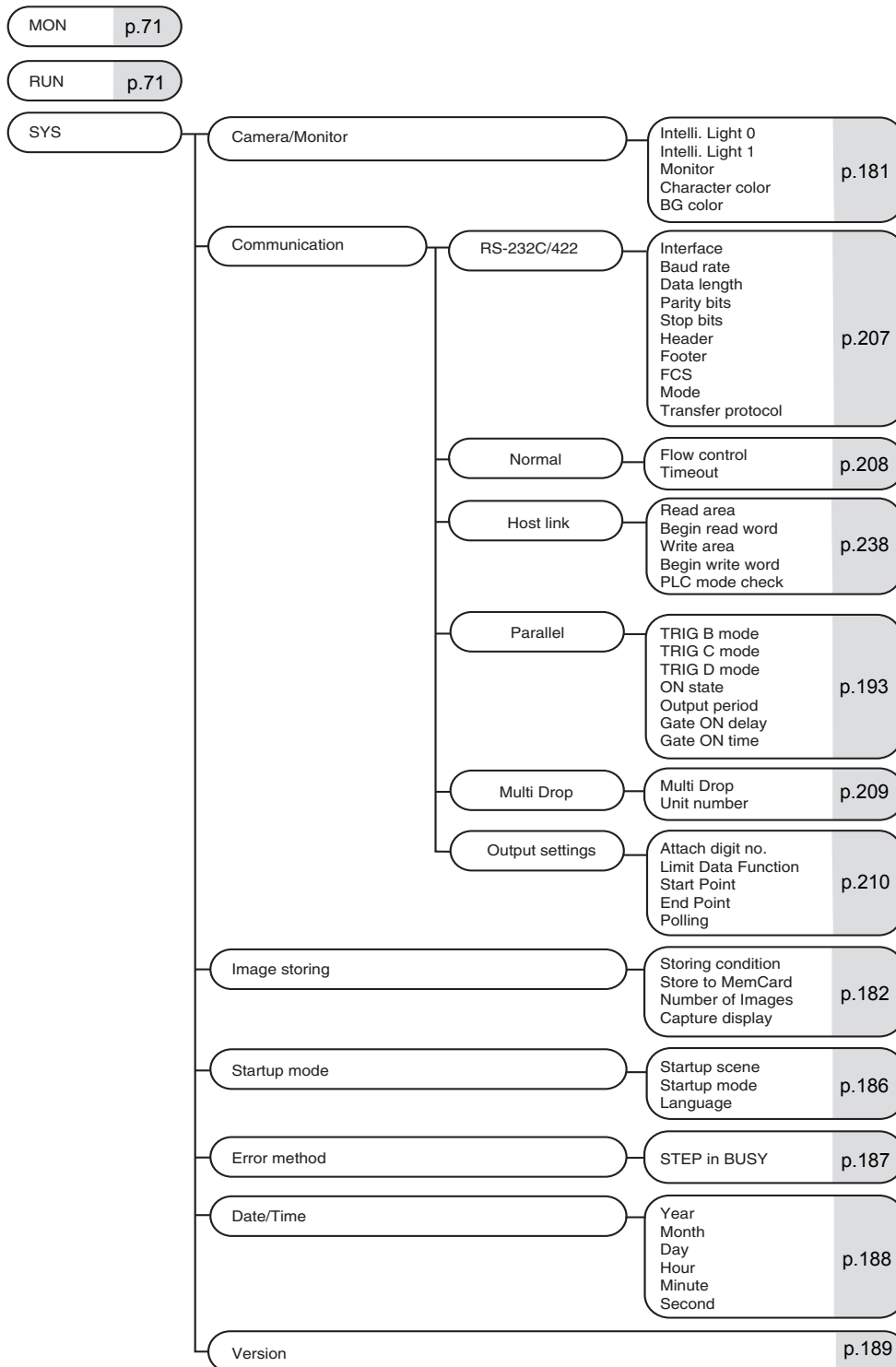

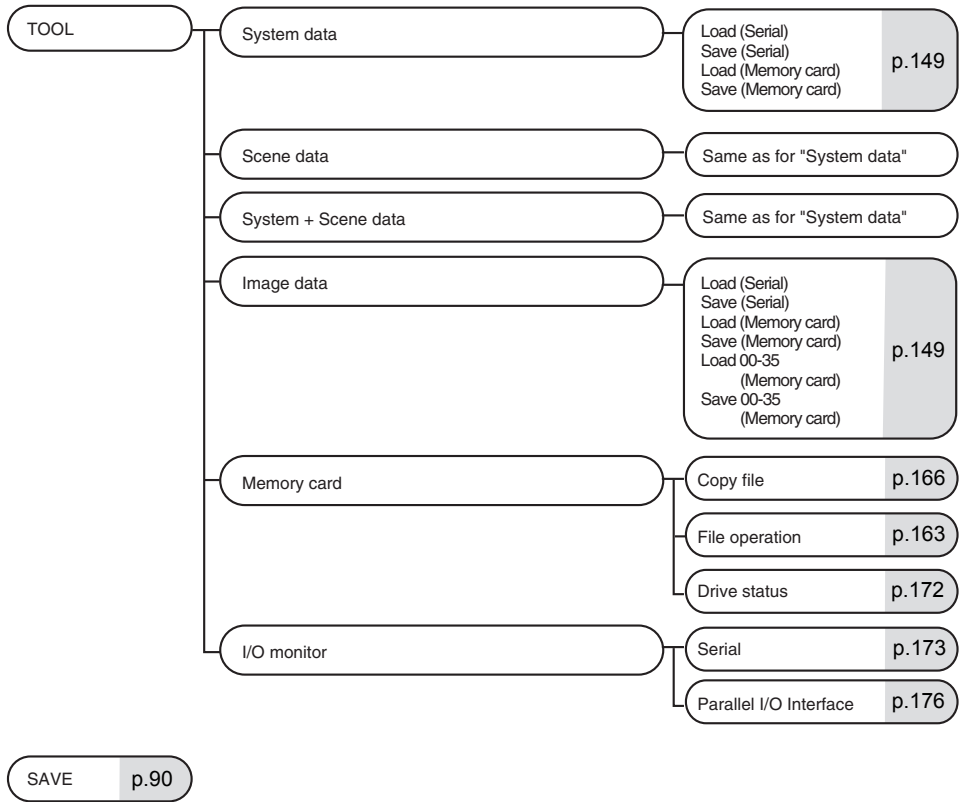



SECTION 1

Outline

This section introduces the functions and operational flow of the controller.

 What is a 2-dimensional Code Reader?	26
 Introduction to Functions	28
 Operational Flow	32

What is a 2-dimensional Code Reader?

It is a device for reading 2-dimensional codes directly marked on products and parts.

2-dimensional code means code that has two dimensions (faces). It permits more data to be written than bar code, which contains information in one direction only.

■ Integration of Objects and Data

In the case of critical parts that affect safety, there were calls for the management of history data for each part.

Once 2-dimensional code has been printed on a part so that the object and the corresponding information are “integrated”, part histories can be accurately managed. At the assembly stage too, if the 2-dimensional codes of the parts are read and compiled in a database, the information for individual products can be managed accurately, and in the event that any problem arises, the cause can be traced quickly.

Example: Reading engine part information.

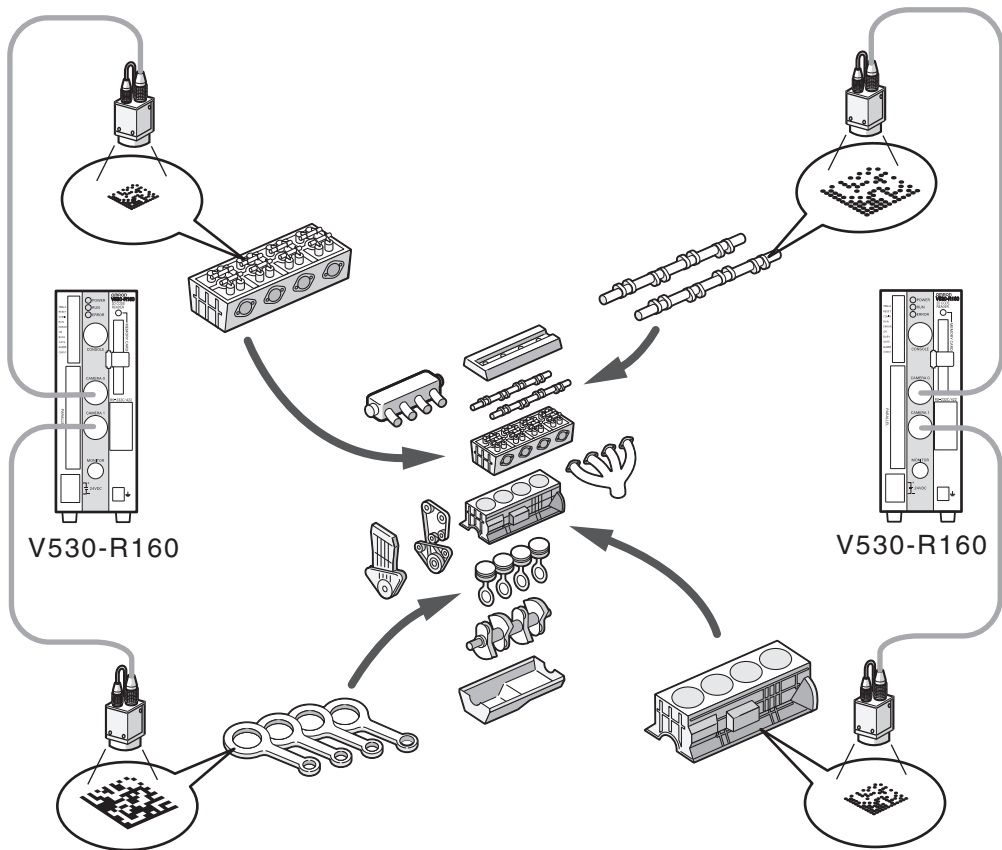

■ The Marking can be Done in a Small Space

Conventional bar codes were too large to be printed on some smaller parts.
2-dimensional codes allow high-density information to be packed into a small space.

Example: Reading printed circuit board information.

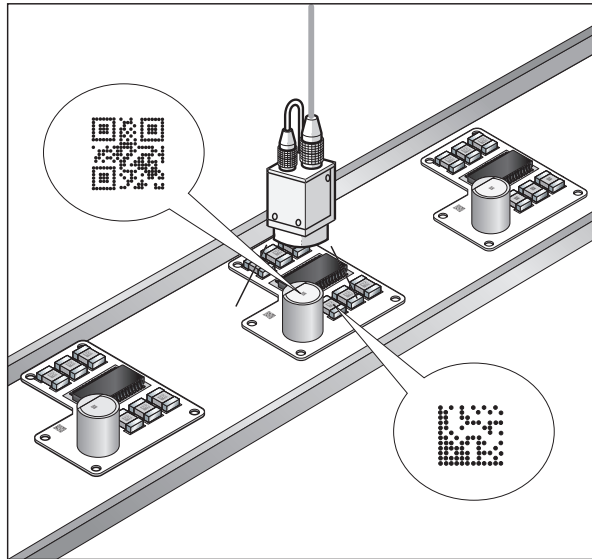

Introduction to Functions

- Reading is possible for both DataMatrix and QRCode.

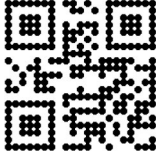
Reading code	DataMatrix	QRCode (Model 1, 2)
		
Corresponding size (Matrix size)	<ul style="list-style-type: none"> •ECC200 10 × 10 to 64 × 64 8 × 18 to 16 × 48 •ECC000, 050, 080, 100, 140 9 × 9 to 25 × 25 	21 × 21 to 41 × 41 (Version 1 to 6)
Readable direction	360°	
Resolution	Vary according to magnification and features of the lens to be used.	
Reading region		
Reading depth		

 DataMatrix  Refer to page 283 (Sec.10).

 QRCode  Refer to page 283 (Sec.10).



About DataMatrix and QRCode

CHECK!

- Normally, it is necessary to have a margin around the 2-dimensional code. Ensure a margin of at least a cell around both DataMatrix and QRcodes.
- Adjust so that there is only one reading code within the field of vision. Reading cannot be performed correctly if there are more than one code on a screen.
- Adjust the field of vision of a camera for the 2-dimensional code to be at least 5 pixels per cell.

Margin: 1 cell min.

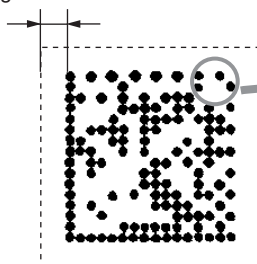

Field of vision of a camera : At least 5 pixels per cell



 Margin  Refer to page 285 (Sec.10).

- 2 cameras can be used for reading.

If two cameras are connected, two types of reading process can be handled with one controller. The scene can be set for each process, and the reading triggers can be input at TRIG C and TRIG D of the parallel I/O.

 Refer to page 194 (Sec.8).

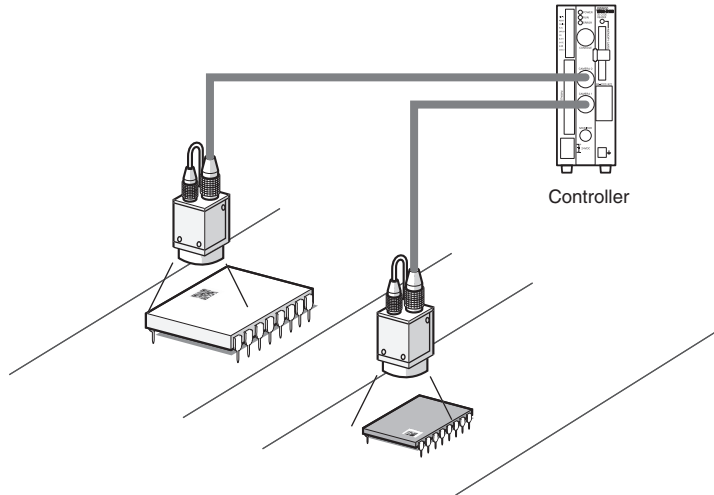

- A memory card slot is provided.

Memory cards can store settings, image and reading data. Since the settings can be stored in the memory card when changing settings, there is no longer any need to bring in a PC for this purpose.

 Refer to pages 51 (Sec.2), 158 (Sec.6), and 163 (Sec.6).

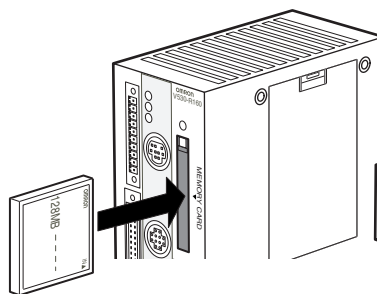

- Dot code images can be converted to easy-to-read images.

Dilate or **Erosion** processing converts code images that have a small dot size and are difficult to read into images that can be read reliably.

 Refer to page 94 (Sec.5).

▪ Result of **Dilate**

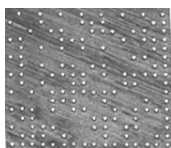

Before processing

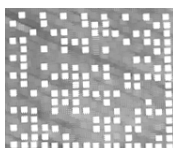

After processing

▪ Result of **Erosion**

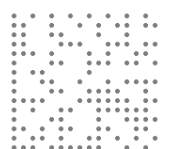

Before processing



After processing

- A maximum of ten patterns can be registered for one scene.

If multiple patterns are registered, even codes subject to dispersion in the dot spacing or printing quality can be read. It is also possible to read codes with different matrix sizes and symbol colors in the same scene.

 Refer to pages 105 (Sec.5) and 130 (Sec.5).

Even codes subject to dispersion can be read.



Up to 10 patterns can be registered.

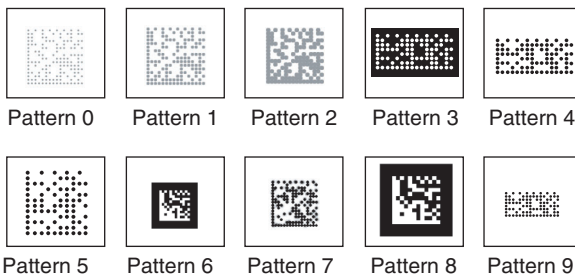

- The reading results over time can be expressed in the form of a graph.

By using the trend monitor display function, trends in the marking status and illumination status of the code can be observed. This can help prevent the occurrence of frequent reading failures, and help in the analysis of the cause of reading failures. Reading history data can be saved in the memory card.



Refer to page 119 (Sec.5).

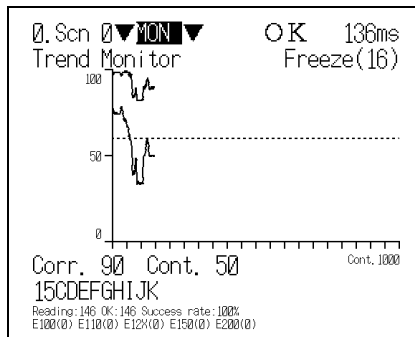

- Image data can be backed up automatically.

Images that you wish to save can be backed up automatically in the memory card.

By backing up the images when reading failures occur, and confirming the time of occurrence and history of failures, trouble can be resolved promptly.



Refer to page 182 (Sec.7).

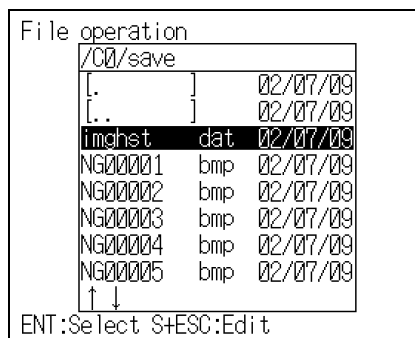

Operational Flow

Installation and Connections



Installation

Refer to page 36.
SECTION 2 Installation and Connections



Connecting the Host

Refer to page 53.
SECTION 3 Connection to the Host

Turn ON the power supply.

Preparation for Reading



Selecting the Menu Corresponding to the Code

Refer to page 76 (Sec.4).
step 1. Select the Code and Capture the Image



Adjust the Image so it is Easy to Read.

Refer to page 92 (Sec.5).
Adjust the image (image input).



Setting the Reading Conditions for the Target Code

Refer to page 79 (Sec.4).
step 2. Set Reading Conditions



Performing Tests

Refer to page 87 (Sec.4).
step 3. Perform Tests



DataMatrix

Refer to page 104 (Sec.5).



QRCode

Refer to page 129 (Sec.5).

Performing Reading



Starting Reading

Refer to page 88 (Sec.4).
step 4. Start Reading

Saving Setting/Reading Data



Saving Reading Conditions

Refer to page 90 (Sec.4).
step 5. Save Settings and
Exit the V530-R160



**Backing Up Data of Images,
Systems, and Scenes**

Refer to page 149 (Sec.6).
Backing up Data



Saving Reading History Data

Refer to page 119 (Sec.5).
Setting Reading Conditions
(DataMatrix)
(Trend Monitor Setting)

Practical Setting Operations



Changing Reading Conditions

Refer to page 112 (Sec.5).
Setting Reading Conditions
(DataMatrix)
(Setting Reading Conditions)



Changing Items Displayed on the Monitor

Refer to page 114 (Sec.5).
Setting Reading Conditions
(DataMatrix)
(Display Settings)



Condition Setting for Each Model

Refer to page 144 (Sec.6).
Changing Scenes (Scene function)



**Setting Conditions Relating to the
System Environment**

Refer to page 179 (Sec.7).
System Settings



**Setting the Communications
Specifications of V530-R160
and I/O Format**

Refer to page 191 (Sec.8).
Communication with the Host

Changing or Clearing Settings



**Copying or Clearing Reading Conditions /
Changing Setting Names**

Refer to page 144 (Sec.6).
Changing Scenes (Scene function)

Other Functions



Using Memory Cards

Refer to page 163 (Sec.6).
Memory Card Operations



**Checking Specifications for
Communications with the Host**

Refer to page 173 (Sec.6).
Checking I/O Status with Host
Devices (I/O Monitor)

Troubleshooting



**An Error Code and Error Message
is Displayed on the Screen.**

Refer to page 253 (Sec.9).
Error Codes and Countermeasures
Refer to page 257 (Sec.9).
Error Messages and Corresponding
Corrective Actions



Troubleshooting

Refer to page 261 (Sec.9).
Troubleshooting



Unsure of the Meaning of a Term?

Refer to page 283 (Sec.10).
Glossary









MEMO

SECTION 2

Installation and Connections

This section explains how to install the Controller and connect the peripheral devices.

 Basic System Configuration	36
 Component Names and Functions	38
 Mounting the Controller	39
 Connecting Peripheral Devices	43
 Power Supply and Ground	44
 Cameras, Lenses, Lighting, and Memory Cards	46

Basic System Configuration

NOTICE

Components marked with an asterisk are specially designed for the V530-R160. Other products cannot be used. (Using other products may damage other components in the system.)

SECTION 2
Basic System Configuration

Controller

The V530-R160 reads the 2-dimensional code specified by the reading conditions and outputs the reading judgement.

* Console
F150-KP-2D
(Cable length: 2 m)

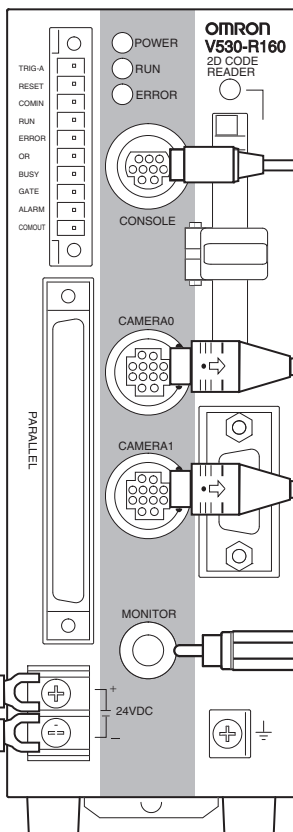
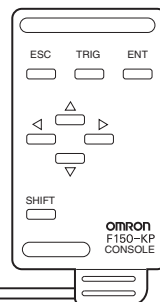

* Camera cable
F150-VS-2D (3 m)

Monitor cable
F150-VM-2D (2 m)

Power supply p.45

The power supply is capped in place to protect against electric shock while the V530-R160 is shipped.

Recommended model:
OMRON S8VS-06024

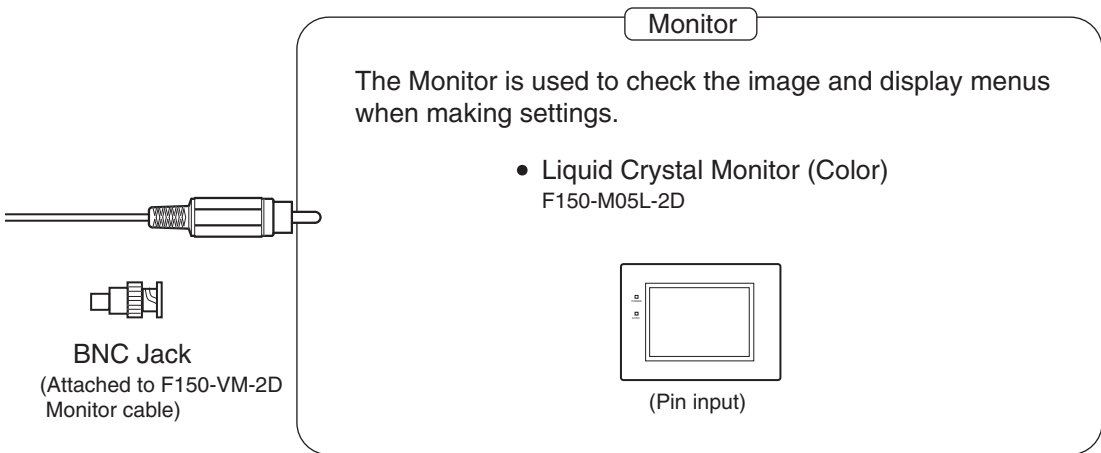
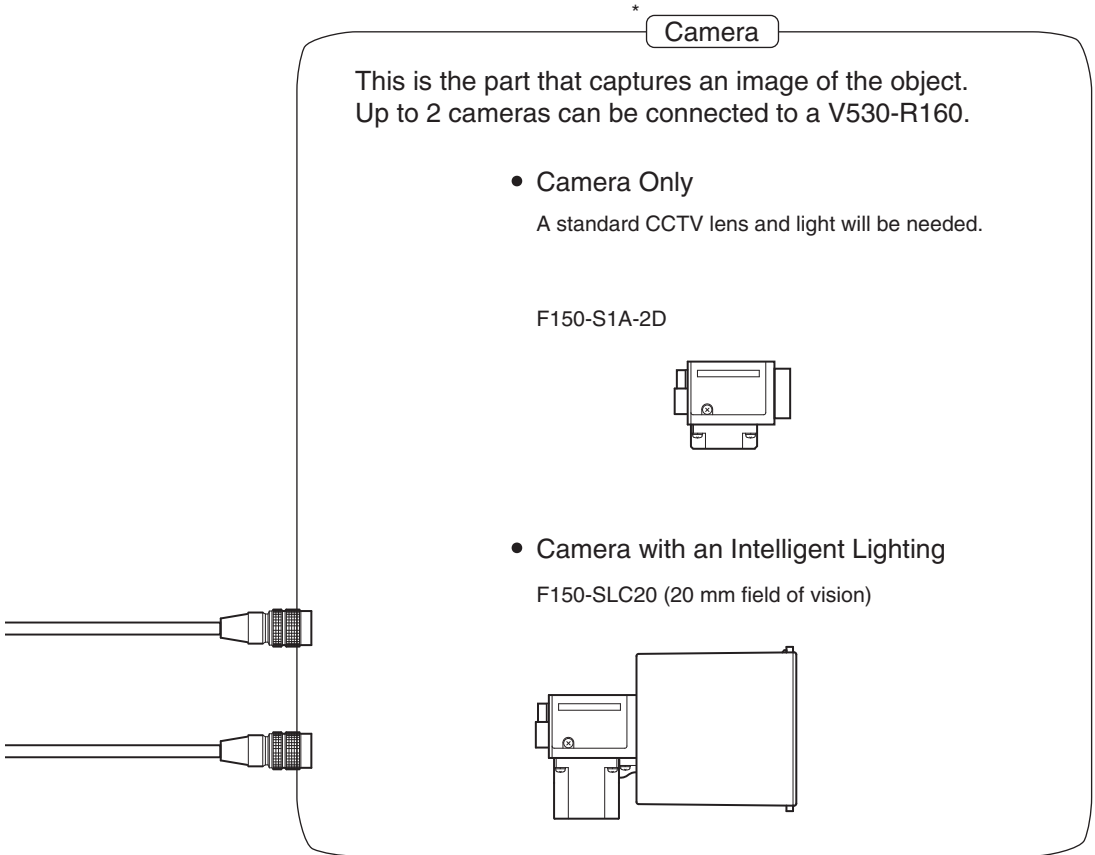

Note: Other monitors equipped with an NTSC external video input terminal can also be used.

Component Names and Functions

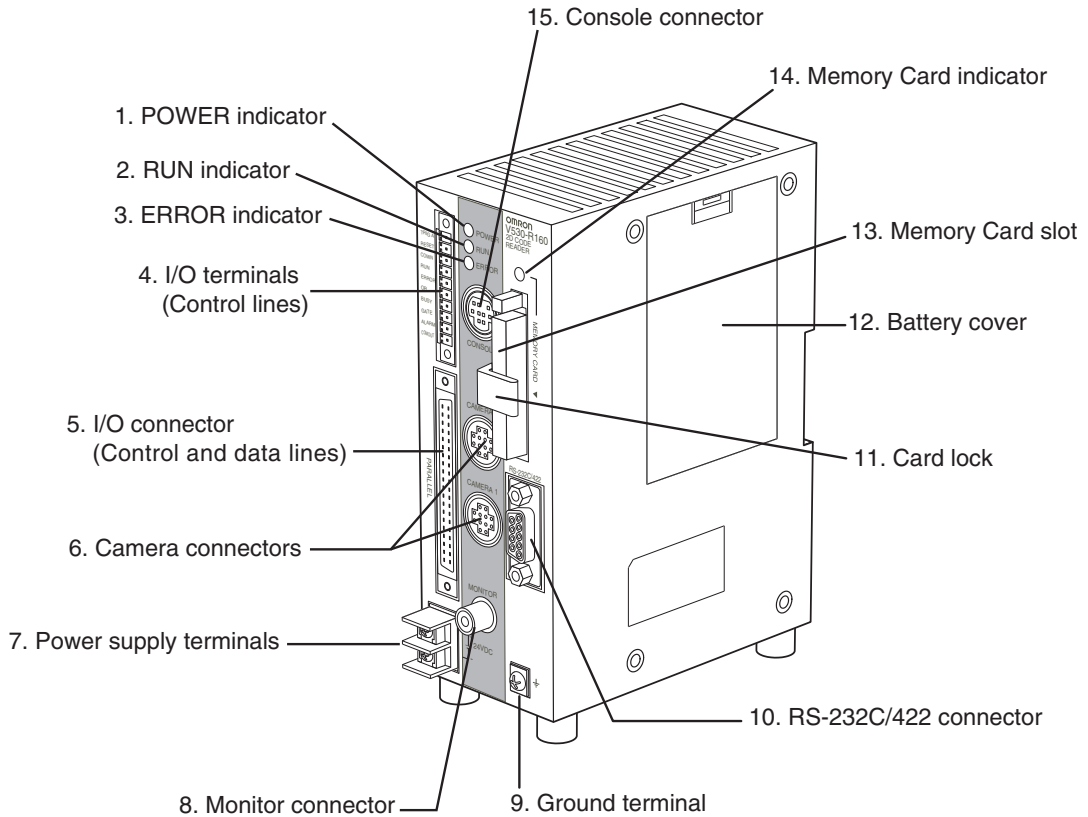

1. Lit while power is ON.
2. Lit in RUN mode.
3. Lit when an error occurs.
4. and 5. Connects the V530-R160 to host devices such as a sync sensor or PLC.
6. Connects to the Camera.
7. Wired to the power supply.
8. Connects to the monitor.
9. Connects to the ground wire.
10. Connects the V530-R160 to a host device such as a personal computer or PLC.
11. This lock secures the Memory Card so that it does not disconnect unintentionally due to vibration.
12. Covers the compartment that contains the V530-R160's battery.
13. This slot receives the Memory Card.
14. Lit when power is being supplied to the Memory Card. (The Memory Card must not be inserted or removed when this indicator is lit.)
15. Connects the V530-R160 to a Console.

Mounting the Controller

There are four ways to mount the Controller: “DIN Track mounting”, “rear surface-mounting”, “side surface-mounting”, or “bottom surface-mounting”.

DIN Track Mounting

The 2-Dimensional Code Reader can be easily mounted to or removed from 35-mm DIN Track.

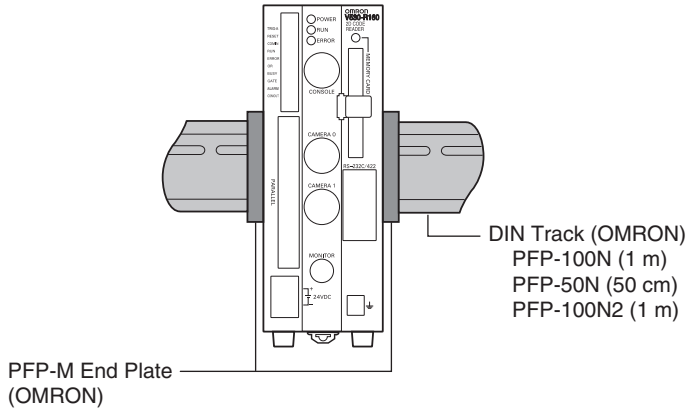

Mounting the Controller

Hook the V530-R160 into the DIN Track as shown in the diagram and then press in at the bottom until the V530-R160 locks into place.

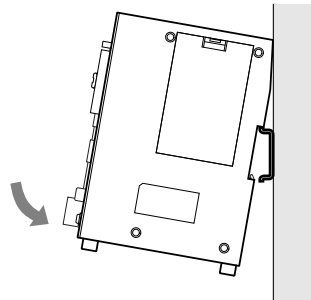

Removing the Controller

Use a screwdriver to pull the hook down and then pull out the V530-R160 from the bottom.

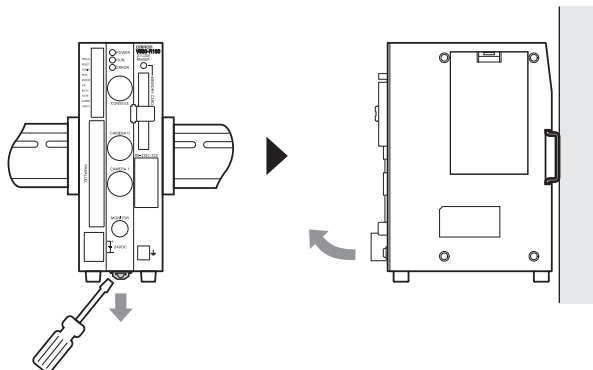

Rear Surface-mounting

1. Attach the Mounting bracket to the V530-R160 Controller using the four machine screws (M3 × 6) included with the bracket.

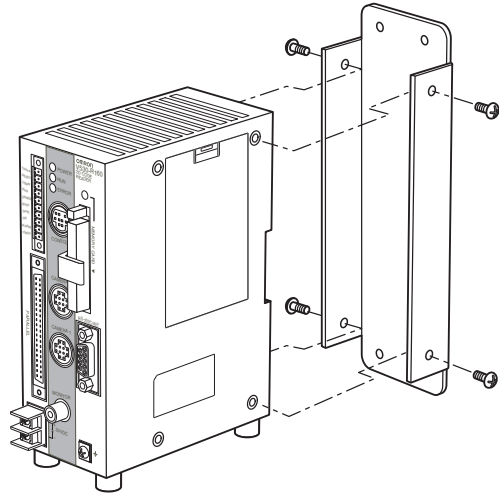

2. Fasten the V530-R160 Controller and Mounting Bracket to the mounting surface with four M4 screws.

Dimensions

(Unit: mm)

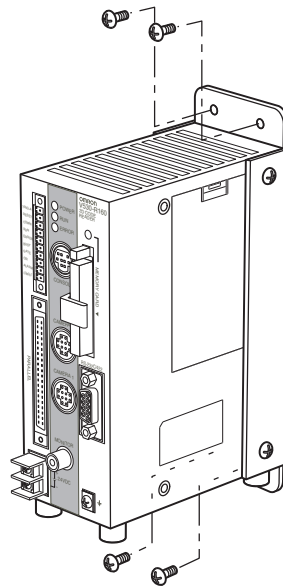
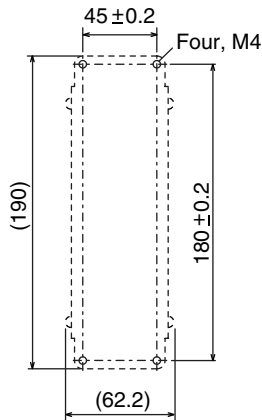

Side Surface-mounting

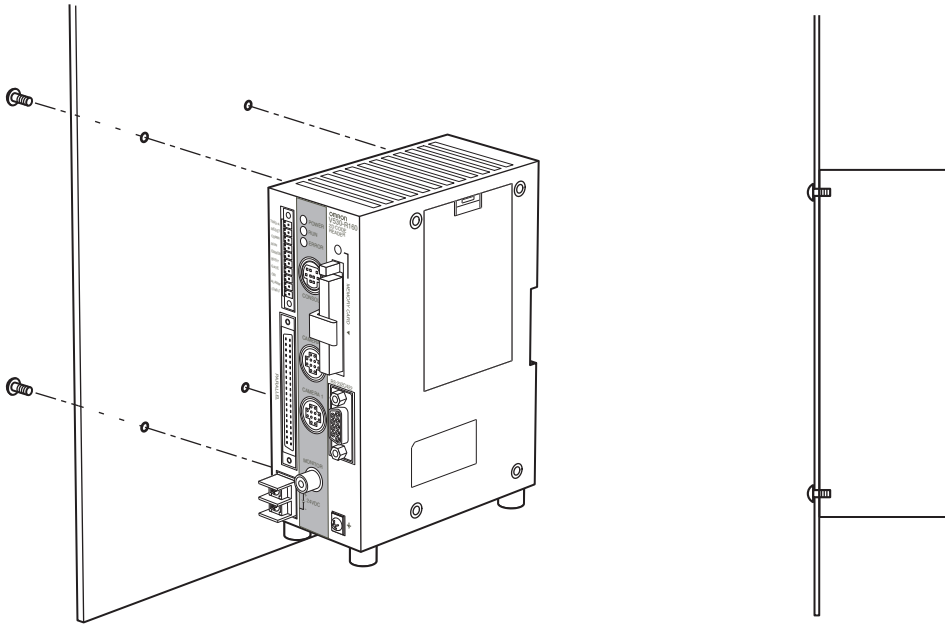

Dimensions

(Unit: mm)

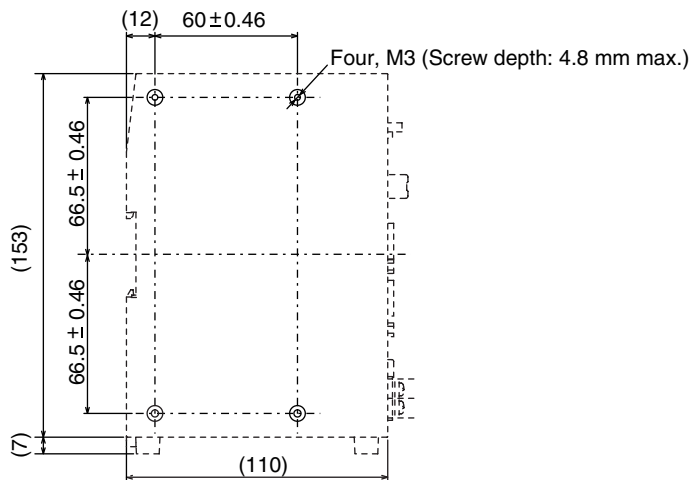

Bottom Surface-mounting

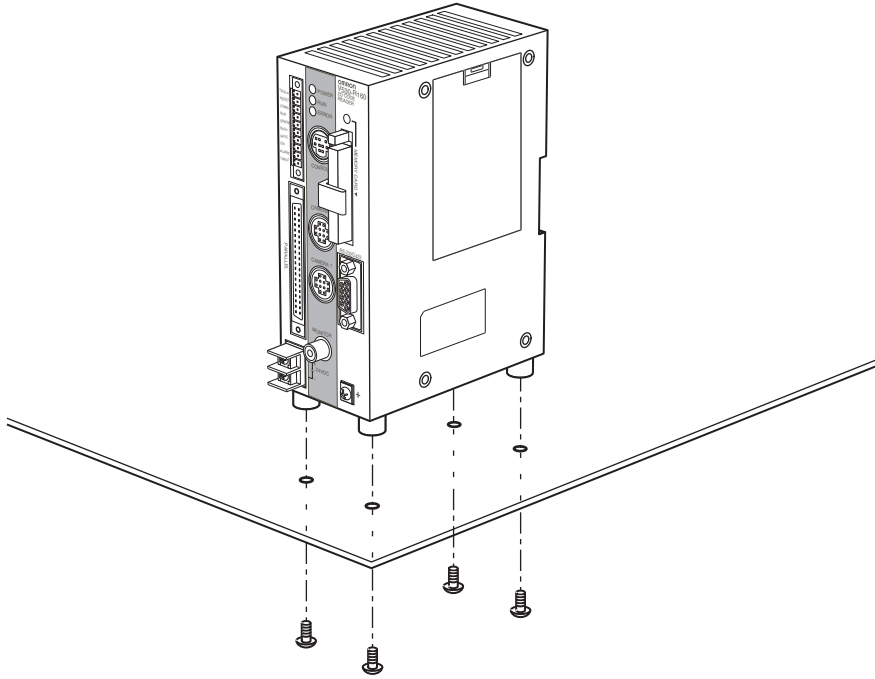

Dimensions

(Unit: mm)

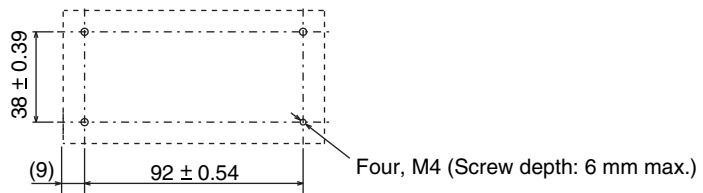

Connecting Peripheral Devices

This section shows how to connect peripheral devices to the V530-R160.

NOTICE

- Turn OFF the power to the V530-R160 before connecting or disconnecting cables. Peripheral devices can be damaged if connected or disconnected with the power supply turned ON.
- The connector is capped when the V530-R160 is shipped. When not using the connector, leave the cap in place to protect against dust, dirt, and static electricity.

Connecting a Console

Connect the Console to the V530-R160's CONSOLE connector. An F150-KP-2D Console can be connected.

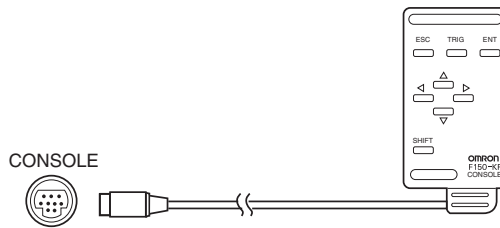

Connecting a Monitor

Connect the Monitor cable to the V530-R160's MONITOR connector, and attach the enclosed Ferrite Core to the Monitor cable. The Ferrite Core should be attached to the cable approximately 10 mm from the MONITOR connector.

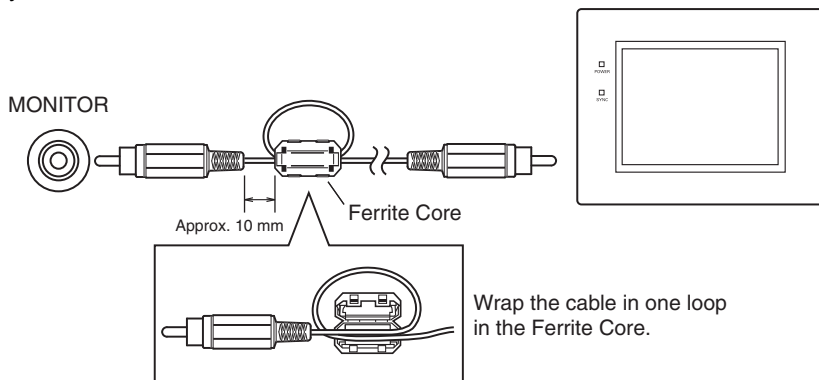

Connecting a Camera

Connect the Camera cable to the V530-R160's CAMERA connector.

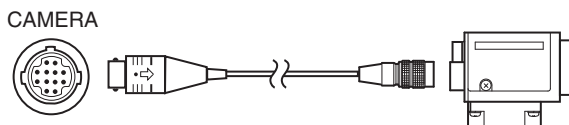

Power Supply and Ground

Wire the power supply and the ground to the top terminal block, and tighten the screws to a torque of 0.49 N·m. After wiring, check to make sure that the wiring is correct.

Crimp Terminals and Cables

The terminal block uses M3 terminal screws.
Use appropriate crimp terminals for M3 screws, as shown below.

Recommended Model

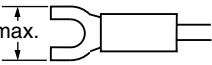
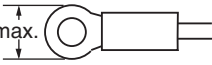
	Manufacturer	Model	Recommended wire size
Forked 	J.S.T. Mfg Co., Ltd.	V1.25-N3A	1.31 to 1.65 mm ²
Round 	J.S.T. Mfg Co., Ltd.	V1.25-MS3	

Ground Wiring

Be sure to wire the protective conductor of the equipment independently. To avoid damage to the equipment, do not share the protective conductor wiring with any other devices nor wire the protective conductor terminal to the girder.
Keep the ground line as short as possible.

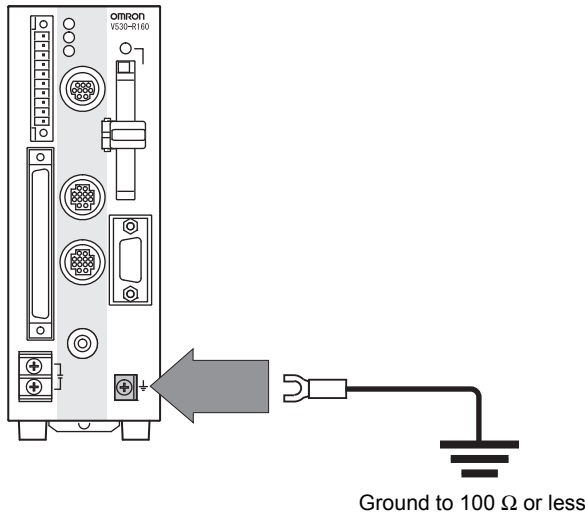

Wiring the Power Supply

Wire the Power Supply Unit independently of other devices. In particular, keep the power supply wired separately from inductive loads.

Use a power supply with the following specifications.

Condition

Output current	Power supply voltage
1.6 A min.	20.4 to 26.4 VDC

Recommended model

Manufacturer	Model
OMRON	S8VS-06024



Use a DC power supply with safe extra low-voltage circuits on the secondary side.
If UL recognition is required, use a UL class II power supply.

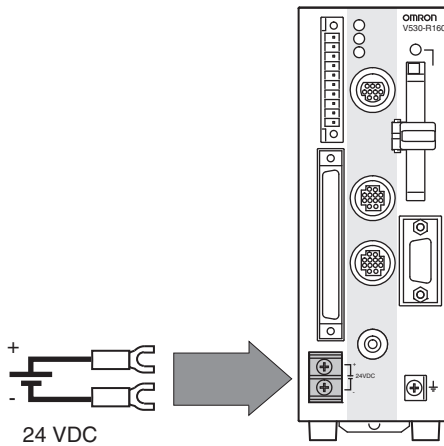

Keep the power supply cable as short as possible (10 m max.).



Cover the power supply with the Terminal Block Protection Cover. Uncovered terminal blocks can cause electric shock.

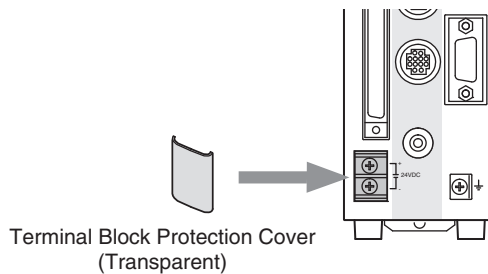

Cameras, Lenses, Lighting, and Memory Cards

This section provides additional information on cameras, CCTV lenses, lighting, and Memory Cards.

Overview of Available Cameras

The F150-SLC20 Camera with Intelligent Lighting is a camera dedicated to the V530-R160 and has a special lens and light already fitted. The light and lens are contained in a single unit, so installation is very simple. Just mount the Camera at the proper distance from the measurement object and it is ready to use.

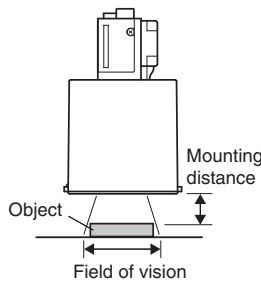
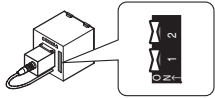
Model	Field of vision and distance to object			Lighting precautions
	Field of vision*	Mounting distance	Relationship between Camera and object	
Camera only F150-S1A-2D	Determine the required field of vision based on the size of the measurement object and select an appropriate CCTV lens (C mount). 			Use lighting that is appropriate for the object being measured.
Camera with an Intelligent Lighting F150-SLC20	20 mm × 20 mm	15 to 25 mm		Use with DIP switch pins 1 and 2 both set to OFF. 

* A camera with a field of vision of 20 mm is optimal for an angle of around 10 mm.
Use the following guidelines for the code's matrix size.

QRCode	21 × 21 (Version 1) to 33 × 33 (Version 4)
DataMatrix	10 × 10 to 26 × 26



Camera with an Intelligent Lighting

The lens focus is fixed and the distance must be adjusted each time the lens or Camera is changed because the field of vision and focus vary from lens to lens.

- Also, the camera's working distance is an approximate value. Mount the camera so that it can be adjusted slightly nearer to or farther from the object.

If the object size and field of vision are incompatible, use a standard CCTV lens and light.



How to mount the camera: Refer to page 269 (Sec.10).

CCTV Lenses

When using a Camera without a light (F150-S1A-2D), refer to the following graph to select the appropriate Lens and Extension Tube. The lens required will differ depending on the size of the object and the distance to the lens (WD).

Optical Chart

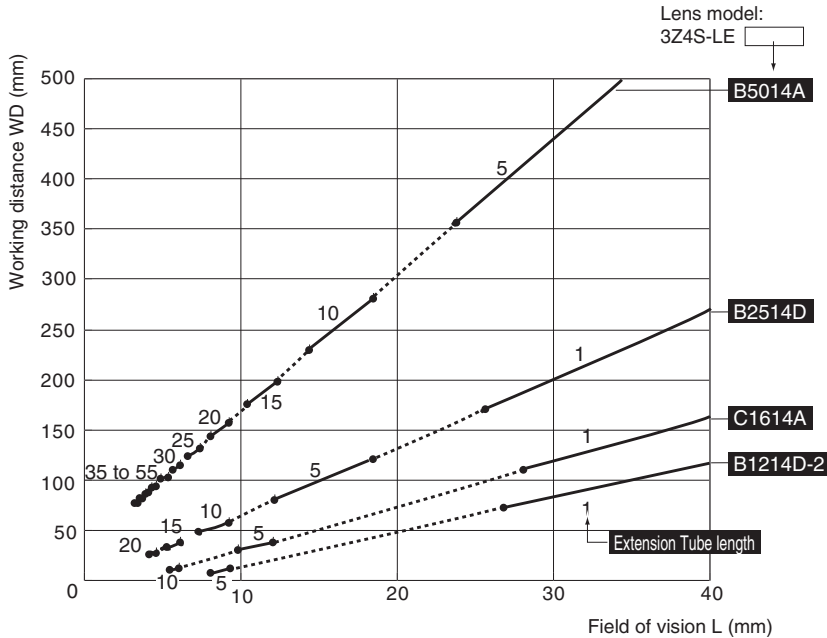

Interpreting the Graph

The horizontal axis of the graph shows the field of vision L (mm), and the vertical axis shows the working distance WD (mm). The curves on the graph show the relationship between the field of vision and camera distance for each CCTV lens. The values are significantly different for each lens, so double-check the model of the lens before using the graph. The values indicate the lengths of the Extension Tubes. The value “0” shows the case where an Extension Tube is not needed and the value “5” shows the case where a 5-mm Extension Tube is used.

Example:

When a 3Z4S-LE C1614A CCTV lens is being used and a field of vision of 10 mm is needed at the measurement object, a working distance of 30 mm and 5-mm Extension Tube are required.

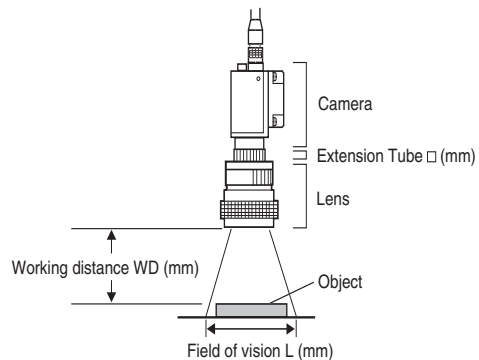

■ Lenses and Lens Diameters

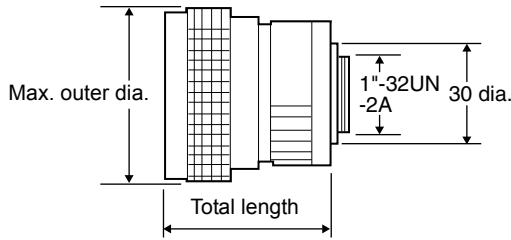

Lenses and Lens Diameters

Lens	Focus length	Brightness	Maximum outer diameter	Total length	Filter size
3Z4S-LE C418DX	4.8 mm	F1.8	40.5 mm dia.	35.5 mm	-
3Z4S-LE B618CX-2	6.5 mm	F1.8	48 mm dia.	42 mm	
3Z4S-LE C815B	8.5 mm	F1.5	42 mm dia.	40 mm	M40.5 × P0.5
3Z4S-LE B1214D-2	12.5 mm	F1.4	42 mm dia.	50 mm	
3Z4S-LE C1614A	16.0 mm	F1.4	30 mm dia.	33 mm	M27 × P0.5
3Z4S-LE B2514D	25.0 mm	F1.4	30 mm dia.	37.3 mm	
3Z4S-LE B5014A	50.0 mm	F1.4	48 mm dia.	48 mm	M46 × P0.75
3Z4S-LE B7514C	75.0 mm	F1.4	62 mm dia.	79 mm	M58 × P0.75

■ Extension Tube

One or more Extension Tubes can be inserted between the lens and the Camera to focus the Camera image. Use a combination of one or more of the six sizes of tube to achieve the required length.

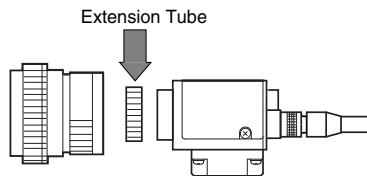

Extension Tube

Model	Maximum outer diameter	Length
3Z4S-LE EX-C6	31 dia.	Length: 40 mm 20 mm 10 mm 5 mm 1.0 mm 0.5 mm Set of 6 tubes

NOTICE

- Do not use the 0.5-mm and 1.0-mm Extension Tubes attached to each other.
- Since these Extension Tubes are placed over the threaded section of the Lens or other Extension Tubes, the connection may loosen when multiple 0.5-mm / 1.0-mm Extension Tubes are used together.
- Reinforcement may be required for combinations of Extension Tubes exceeding 30 mm if the Camera is subject to vibration.

Lighting

A stable image must be obtained to ensure accurate inspection. Use appropriate lighting for the application and the measurement object if using a Camera without a light (F150-S1A-2D).

■ Selecting a Light

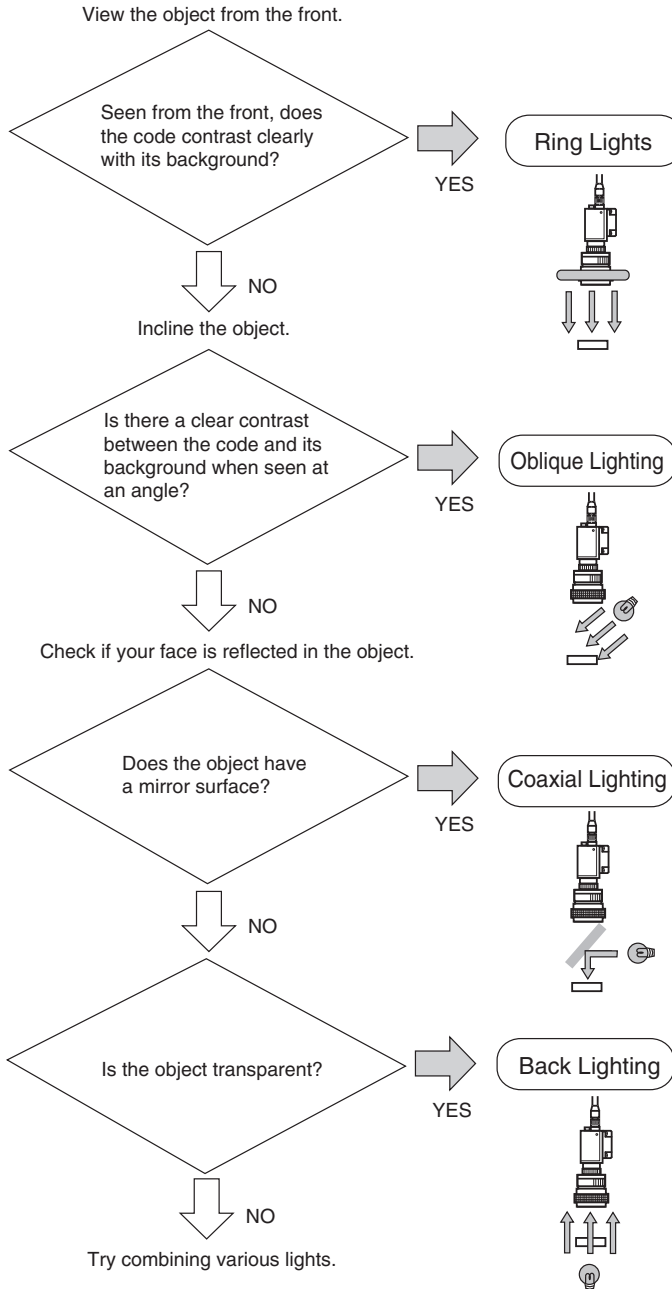

■ **Lighting**

Back Lighting

A stable, high-contrast image can be obtained using back lighting.

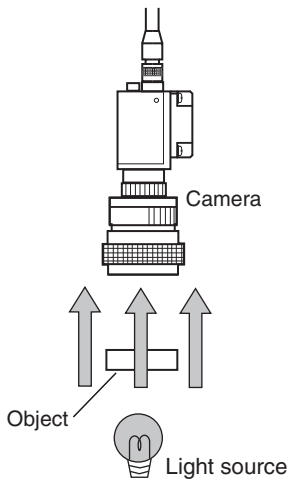

Applications: Reading codes on transparent objects such as sheet glass

Reflected Lighting

Ring Lights

Objects can be illuminated uniformly.

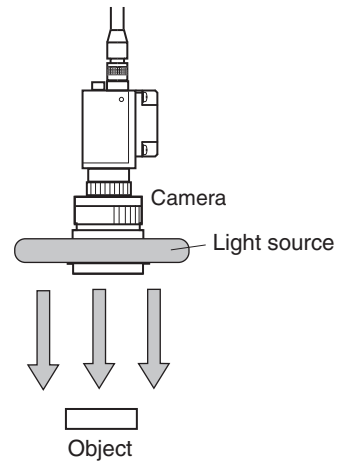

Applications: Printed markings on paper labels and cardboard, stamped markings on engine parts, etc.

Oblique Lighting

By shining the light from an angle, detection is achieved by distinguishing regular and diffuse reflected light.

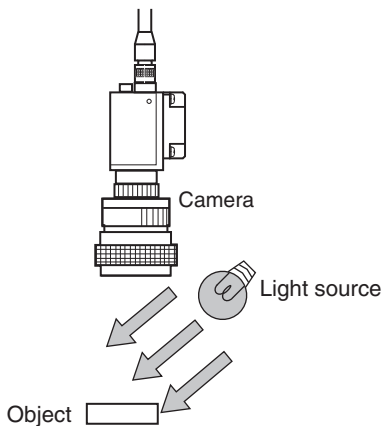

Applications: Direct marking on engine parts, PCBs, electronic components, etc.

Coaxial Lighting

A stable image can be obtained with few shadows from uneven surfaces on the measurement object.

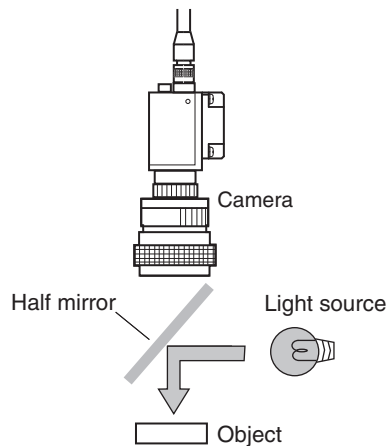

Applications: Reading codes from objects with highly reflective surfaces such as semiconductor wafers

Memory Card

Use a Memory Card to backup data such as settings and image data. Data from the V530-R160 can be backed up in a personal computer just by inserting the Memory Card into the computer and copying the desired data.

Recommended Model

Manufacturer	Model	Capacity
OMRON	F160-N64S(S)	64 MB
OMRON	QM300-N128S	128 MB



A filler card with no memory is inserted into the V530-R160's Memory Card slot when the V530-R160 is shipped. Remove this filler card and install a Memory Card to use this function.

CHECK! If no Memory Card is being used, leave the filler card in place to prevent dust or dirt from entering the Memory Card slot.

■ Installing a Memory Card

1. Open the Memory Card slot's card lock.



Do not force the lock open; lift the latch gently.

CHECK!

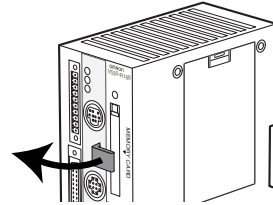

2. Insert the Memory Card.

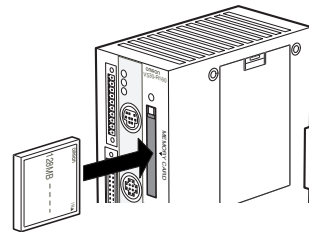

3. Close the card lock to secure the Memory Card.

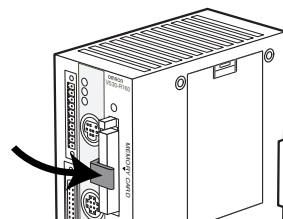

■ Removing the Memory Card

1. Stop the power supply to the Memory Card or turn OFF the V530-R160
 Refer to page 172 (Sec.6).

2. Confirm that the Memory Card indicator is not lit.

NOTICE

Do not remove the Memory Card if the Memory Card indicator is lit. Doing so may damage the Memory Card or the V530-R160 itself.

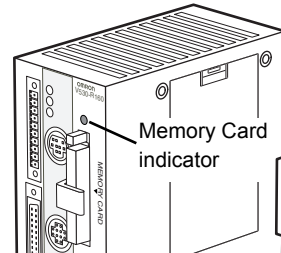

3. Open the card lock.
4. Press the eject button over the Memory card slot.
The memory card will spring out a little.
5. Pull the Memory Card straight out from the slot.

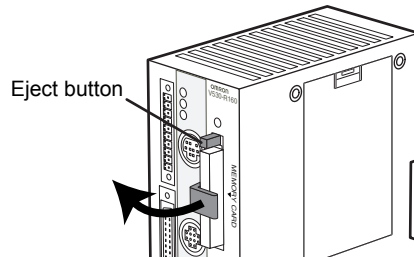

■ Using Memory Cards in a Personal Computer

The V530-R160's Memory Cards can be used in a personal computer with a PC Card drive (PCMCIA2.0/JEIDA4.1 or higher, type II compatible) or Compact Flash™ drive.

The Memory Card must be inserted into a PC Card Adapter in order to be used in a PC Card drive.

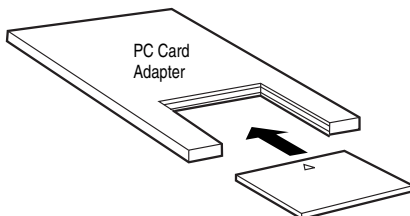



Recommended Model

Name	Manufacturer	Model
PC Card Adapter	OMRON	HMC-AP001

SECTION 3

Connection to the Host

This section describes how to connect host devices through a parallel I/O or serial interface.

 Connecting through the Parallel I/O	54
 Connecting through the Serial Interface	60

Connecting through the Parallel I/O

This section explains how to connect inputs and outputs to the V530-R160 through its parallel I/O to input signals such as reading triggers, or output signals such as reading judgements (OK/NG).

Either the “I/O terminals” or “I/O connector” can be used for the parallel I/O. The I/O terminals and I/O connector cannot be used simultaneously.

When the required control signals are being connected to the I/O terminals, attach the control wires to the included connector (Phoenix MC1.5/10-STF-3.5) and then insert the connector into the V530-R160.

When you want to use the parallel I/O to output reading judgements by inputting a trigger, prepare a parallel I/O cable (order separately) and connect it to the I/O connector.

For details on how to set the communication specifications and the I/O format, see *SECTION 8 Communications with the Host*.

I/O Terminal Connections

■ Connecting Method

Wire the cable carrying the control signals to the connector that was included with the V530-R160 and insert the connector into the V530-R160. The following diagram shows the I/O allocation of the V530-R160's I/O terminals. Just wire the terminals that are needed.

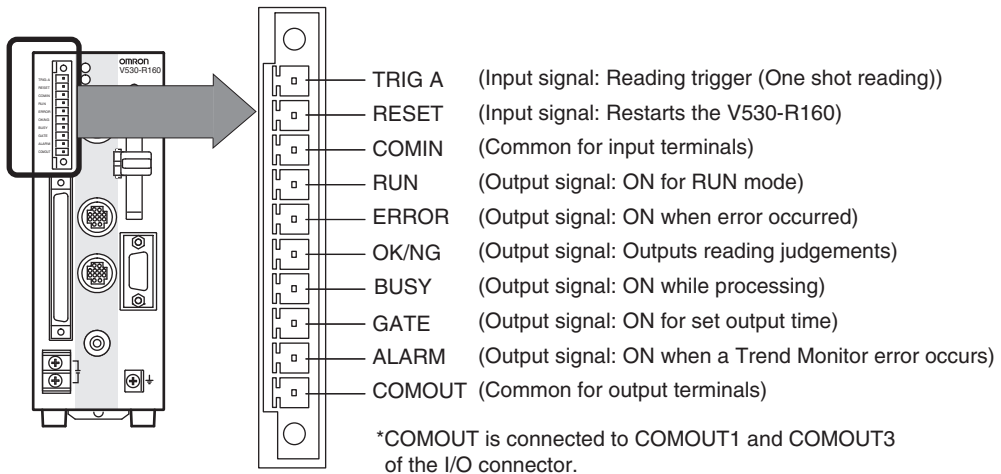

NOTICE Do not use RESET input immediately after the power is turned ON. When using RESET input to synchronize execution timing, wait at least 1 second after turning ON the V530-R160 power supply before turning ON the RESET terminal.

 Use DC power supplies with safe extra low-voltage circuits for COMING in order to prevent high voltages. If UL recognition is required, use a UL class II power supply.
CHECK!

■ Recommended Wire Size

0.14 to 1.5 mm² (The maximum cable length is 30 m.)

1. Use a flat-blade precision screwdriver to loosen the connector's set screw.

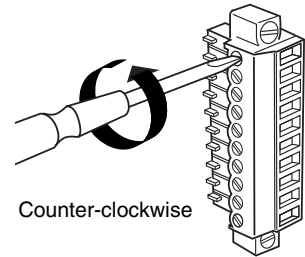

2. Insert the signal wire.

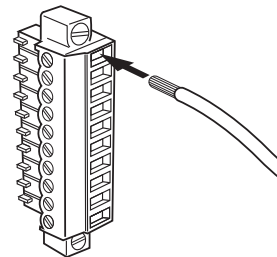

3. Tighten the set screw to secure the wire. Tighten to a torque of 0.22 to 0.25 N·m.

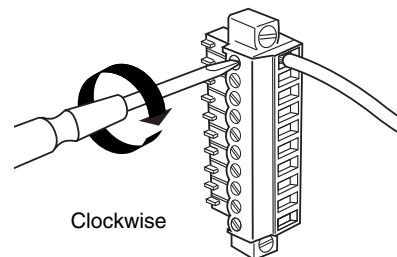

4. Insert the connector into the V530-R160.
5. Tighten the connector's mounting screws. Tighten to a torque of 0.22 to 0.25 N·m.

I/O Connector Connections

Use a F160-VP Parallel I/O Cable (order separately) to connect to the V530-R160's I/O connector. Align the connectors and insert the cable's connector straight into the V530-R160's I/O connector. Tighten the connector's mounting screws to secure the connection.

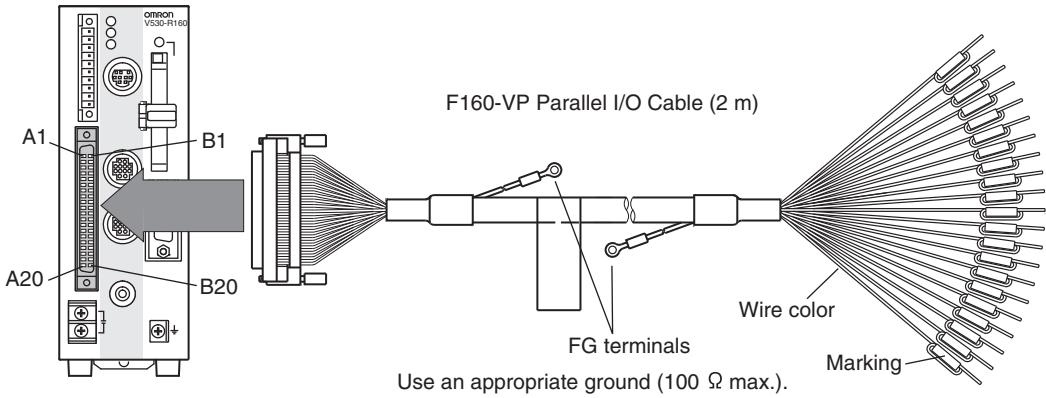

NOTICE

- Turn OFF the power to the V530-R160 before connecting or disconnecting cables. Peripheral devices can be damaged if connected or disconnected with the power supply turned ON.
- A cover is screwed onto the connector when the V530-R160 is shipped. When not using the I/O connector, leave the cover in place to protect against dust, dirt, and static electricity.

Pin	Signal	Wire color	Marking (Black)	Function	Pin	Signal	Wire color	Marking (Red)	Function
A1	RESET	Light brown	■	Restarts the V530-R160.	B1	COMIN	Light brown	■	Common for input signals
A2	TRIG A	Yellow	■	Trigger input (One shot reading)	B2	DSA	Yellow	■	Do not use.
A3	TRIG B	Green	■	Trigger input (Continuous/level trigger)	B3	TRIG C	Green	■	Trigger input (Scene setting, level trigger)
A4	TRIG D	Gray	■	Trigger input (Scene setting, level trigger)	B4	—	Gray	■	Do not use.
A5	—	White	■	Do not use.	B5	—	White	■	Do not use.
A6	—	Light brown	■						
A7	—	Yellow	■						
A8	—	Green	■						
A9	RUN	Gray	■	ON while in RUN mode	B9	ERROR	Gray	■	ON when an error has occurred
A10	BUSY	White	■	ON during processing	B10	GATE	White	■	ON for the set output time
A11	OK/NG	Light brown	■	Outputs reading judgments	B11	COMOUT1	Light brown	■	Common for control signals (See note.)
A12	DO0	Yellow	■	Do not use.	B12	DO1	Yellow	■	Do not use.
A13	DO2	Green	■						
A14	DO4	Gray	■						
A15	DO6	White	■						
A16	DO8	Light brown	■						
A17	DO9	Yellow	■						
A18	DO11	Green	■						
A19	DO13	Gray	■						
A20	ALARM	White	■	ON when a Trend Monitor error occurs.	B16	COMOUT2	Light brown	■	Common for DO0 to DO7
					B17	DO10	Yellow	■	Do not use.
					B18	DO12	Green	■	
					B19	DO14	Gray	■	
					B20	COMOUT3	White	■	Common for DO9 to DO15

Note: Pins A9 to A11 and B9 to B10 are for control signals.



Do not use RESET input immediately after power is turned ON. When using RESET input to synchronize execution timing, wait at least 1 second after turning ON the V530-R160 power supply before turning ON the RESET terminal.



Use DC power supplies with safe extra low-voltage circuits for COMIN in order to prevent high voltages. If UL recognition is required, use a UL class II power supply.

■ **Making a Parallel I/O Cable**

A parallel I/O cable can be assembled using the connector and cover listed in the following table or equivalent components. Keep the cable length less than 30 m.

	Manufacturer	Model
Connector	Fujitsu	FCN-361J040-AU
Cover	Fujitsu	FCN-360C040-B



Double-check the connector wiring for mistakes before turning ON the power supply for the first time.

CHECK!

Internal Specifications

Input Specifications

Item	Specification	
Model	V530-R160E (NPN mode)	V530-R160EP (PNP mode)
Input voltage	12 to 24 VDC \pm 10%	
ON current	3 to 15 mA	
ON voltage	8.8 V max.	
OFF current	0.1 mA max.	
OFF voltage	4.5 V min.	
ON delay	RESET input: 10 ms max. Other inputs: 0.5 ms max.	
OFF delay	RESET input: 15 ms max. Other inputs: 0.7 ms max.	
Internal circuits		

Output Specifications

Item	Specification	
Model	V530-R160E (NPN mode)	V530-R160EP (PNP mode)
Output voltage	12 to 24 VDC \pm 10%	
Load current	45 mA max.	
ON residual voltage	2 V max.	
OFF leakage current	0.1 mA max.	
Internal circuits		



The I/O contacts are shared by the I/O terminals and I/O connector. The following diagram shows the wiring diagram for the STEP signal as an example.

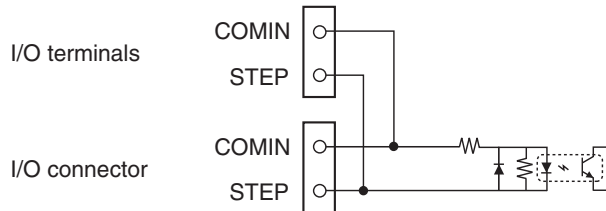

Connecting through the Serial Interface

The V530-R160's serial interface (RS-232C/RS-422 connector) can be used to connect input signals such as reading triggers or output signals such as reading judgements. Additionally, data that has been set in the V530-R160 can be backed up in a personal computer. The connection method is explained here.

For details on how to set the communication specifications and the I/O format, see *SECTION 8 Communications with the Host*.

■ Points to Check before Starting Communications

Check the following points before starting communications using the serial interface.

Points to check	
Is the cable connected properly? Check the cable type, pin numbers, and signals names.	p.61
Are the SYS/Communication settings appropriate? <ul style="list-style-type: none"> • Is the communications mode setting at SYS/Communication/RS-232C/422 appropriate? For a no-protocol connection ... Normal For a host link connection ... Host link • When the 1:1 connection is made, is the SYS/Communication/Multi-drop setting OFF? • Is the SYS/Communication/Data Output Setting/Polling setting OFF? 	p.206 (Sec.8) p.236 (Sec.8) p.209 (Sec.8) p.210 (Sec.8)
Is the controller set to the RUN mode?	—



If there is no problem with these settings but proper communications cannot be established, see *SECTION 9 Troubleshooting*.

CHECK!



Refer to page 261 (Sec.9)

Connector

The V530-R160's RS-232C/422 Connector is a D-SUB female connector (M2.6). The pin allocation is shown below.

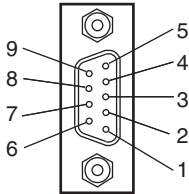

Pin	Signal	Function
1	FG	Protective frame ground
2	SD	RS-232C
3	RD	RS-232C
4	NC	Not connected
5	RDB(RD+)	RS-422
6	RDA(RD-)	RS-422
7	SDB(SD+)	RS-422
8	SDA(SD-)	RS-422
9	GND	Signal ground

■ RS-422 Block Diagram

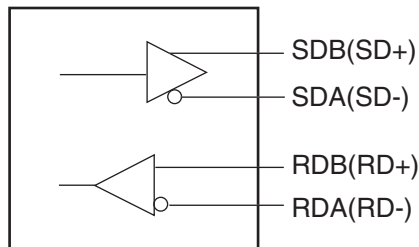

Use a compatible connector.

Recommended Model

	Manufacturer	Model
Plug	OMRON	XM2A-0901
Hood	OMRON	XM2S-0911

Connection Examples

■ 1:1 Connection (Personal Computer)

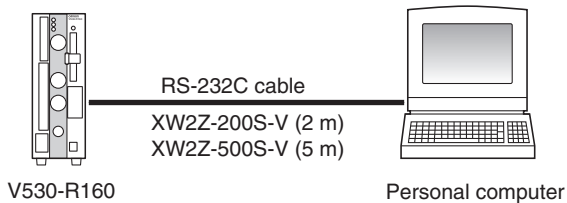

■ Cable Wiring (XW2Z-200S-V/XW2Z-500S-V)

The maximum cable length is 15 m.

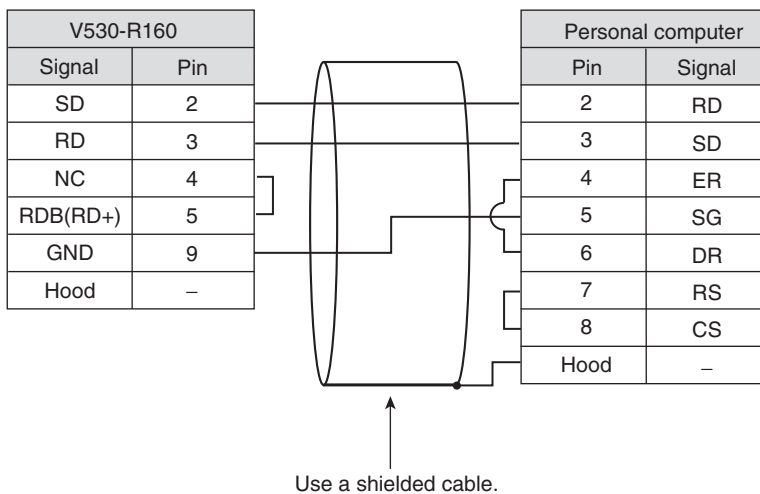

■ 1:1 Connection (Programmable Controller)

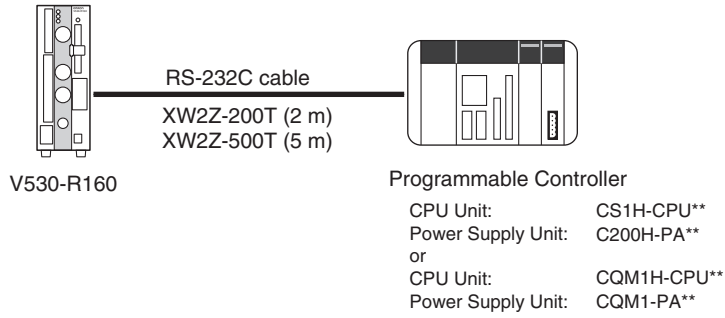

■ RS-232C Cable Wiring (XW2Z-200T/XW2Z-500T)

The maximum cable length is 15 m.

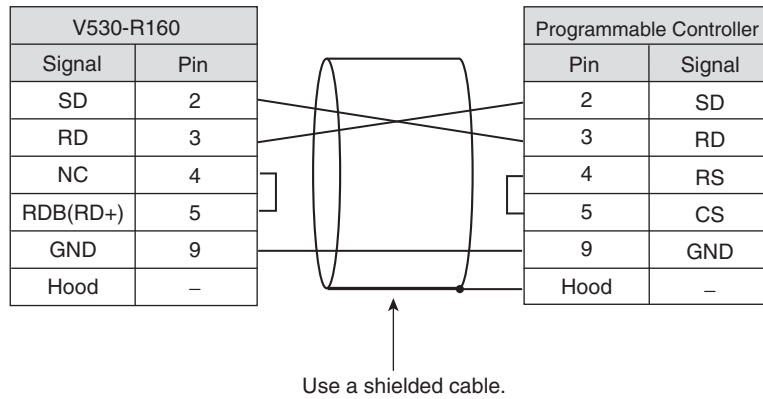

■ **1:N Connection (Multi-drop)**

A branching link adapter enables communication with multiple controllers (up to 31) from one host.

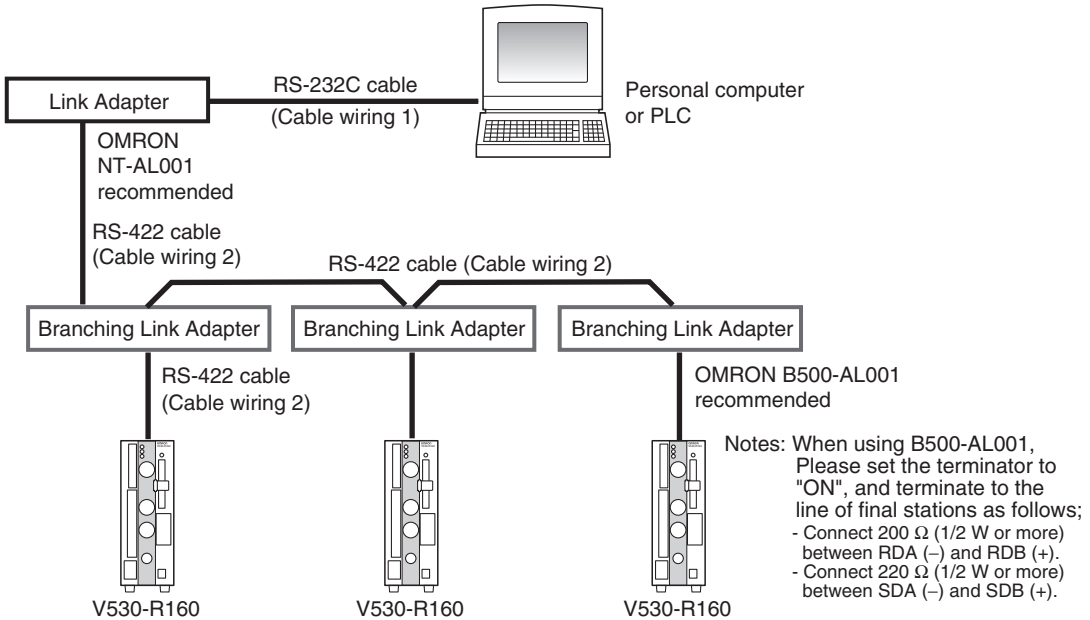

■ **Cable Wiring 1**

(RS-232C (Connection between the Host and Link Adapter))

The maximum cable length is 15 m.

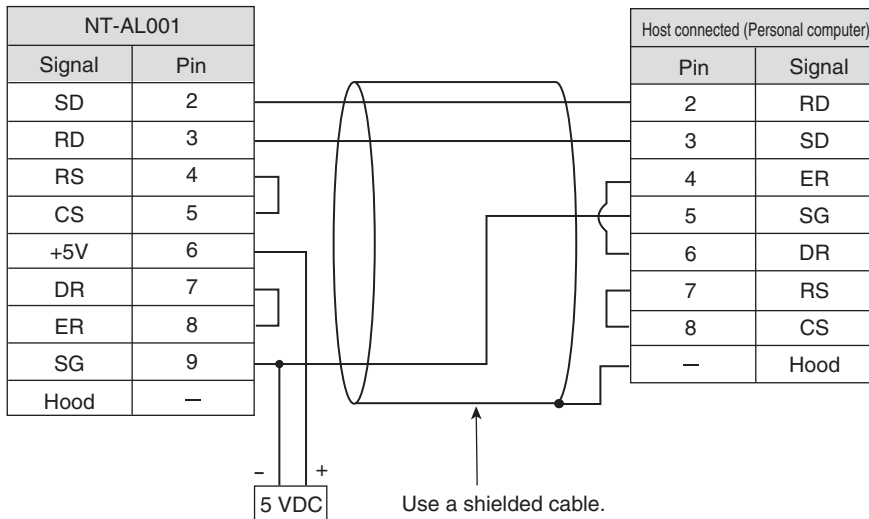

Note: The pin numbers at the host device will depend on the device being connected. Refer to the manual for the personal computer or PLC being connected. (The cable wiring shown above is an example of a connection with a personal computer.)

▪ **Cable Wiring 2**

(RS-422 (Connection between a Controller and Branching Link Adapter, or between Branching Link Adapter))

Use an AWG22 shielded cable or equivalent.

For SDB and SDA, and RDB and RDA, use twisted pair cables.

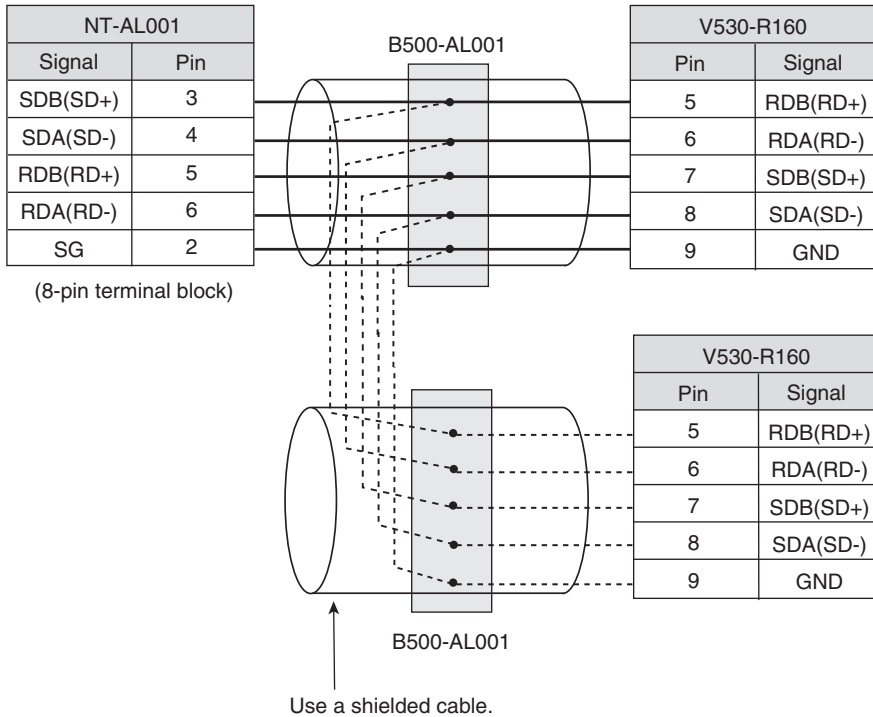

Connection

Align the connectors and insert the cable's connector straight into the V530-R160's I/O connector. Tighten the connector's mounting screws to secure the connection.

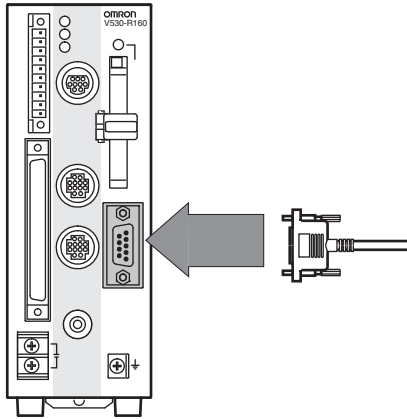

NOTICE

- Turn OFF the power to the V530-R160 before connecting or disconnecting cables. Peripheral devices can be damaged if connected or disconnected with the power supply turned ON.
- The connector is capped when the V530-R160 is shipped. When not using the serial interface, leave the cap in place to protect against dust, dirt, and static electricity.

SECTION 4

Basic Operations

This section describes the basic menu operations.

☒	Starting the Controller	68
☒	Basic Knowledge of Operations	70
☒	Understanding Setting Operations	76
step1	Select the Code and Capture the Image	76
step2	Set Reading Conditions	79
step3	Perform Tests	87
step4	Start Reading	88
step5	Save Settings and Exit the V530-R160	90

Starting the Controller

Enter the controller's menu.

1. Be sure that the basic system components have been connected correctly.

 Refer to page 36 (Sec.2).

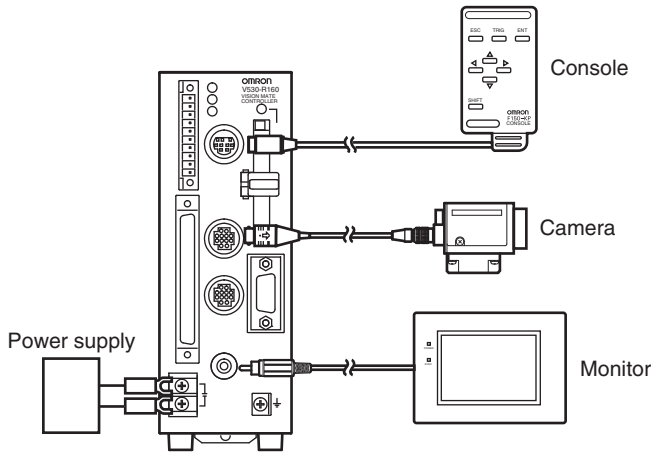

2. Turn ON the power supply on the monitor.
3. Turn ON the power supply to the V530-R160.

▼
The Camera/Monitor setting screen will be displayed.

4. When using Intelligent Lighting, select **LTC20**.

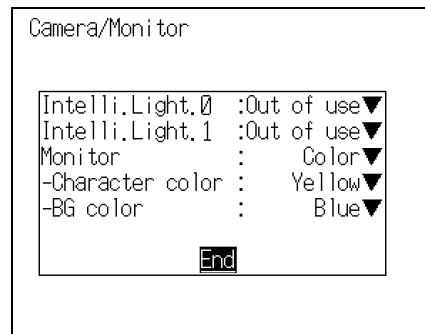

5. Select the monitor type to be connected.
6. When connecting a color monitor, select **Character color** and **BG color**.
7. Select **End**.

▼
The main screen will be displayed.

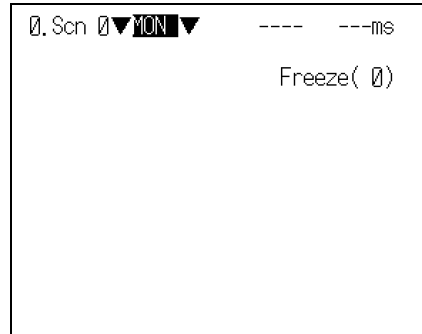

When the settings have been completed, it is useful to use **Startup** Mode when actually operating the V530-R160.

CHECK!

Startup Mode is used to set the startup conditions (display screen) when the V530-R160 is next started. For example, set the V530-R160 to start in **RUN** Mode. This will allow readings to be started immediately and will make day-to-day operations easier.



Refer to page 186 (Sec.7).

NOTICE

Never input the RESET signal or turn OFF the power when startup messages are displayed. Data may be lost, and the V530-R160 may not operate properly the next time it is started.

Basic Knowledge of Operations

Input Devices

Menu operations are performed on the Console.
The basic functions of the Console keys are as follows.

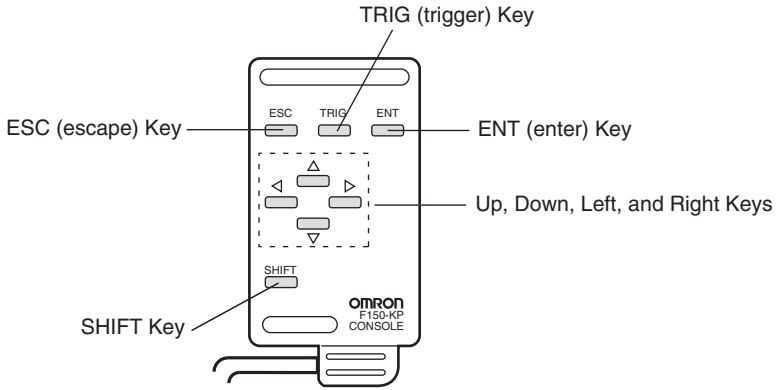

Key	Function
ESC Key	Returns the cursor to the previous menu display or operation.
TRIG Key	Executes reading.
ENT Key	Executes a function or sets a value.
SHIFT Key	Must be pressed in combination with another key to have any affect. Specific functions are assigned to SHIFT + another key for specific screens.
Up, Down, Left, and Right Keys	<p>Up/Down Keys: Used to move the cursor up and down to select items. Also used to set values. The Up Key increases a value by 1 and the Down Key decreases a value by 1. Hold down the Up or Down Key to quickly increase or decrease a value.</p> <p>Left/Right Keys: Used to move the cursor left or right.</p>

Screen Displays

Basic Screen Configuration

Scene Number

There are 10 scenes. Setting different measurement conditions for each one allows easy switching between different set-ups.

Mode (See note 1.)

The current mode is displayed.

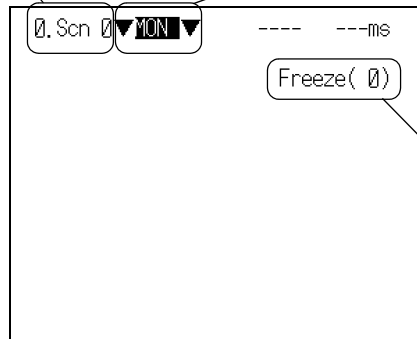

The type of image being displayed is shown. (See note 2.)



Refer to page 72.

Note 1:

Mode

Display	Description
SET	Used to set reading conditions.
MON	Used to confirm the reading can be properly performed under the set conditions. The reading judgements are displayed on the monitor only. The results cannot be output to the host.
RUN	Used to read codes. The reading judgements are output to a host via the serial interface.
SYS	Used to set system conditions for the V530-R160.
TOOL	Provides the data backup menu and memory card-related menus. Used to back up setting data or image data to a computer or a Memory Card.
SAVE	Used to save setting data to flash memory. If new settings have been made, be sure to save the data before quitting.

Note 2:

Display Image

Display	Description
Freeze <input type="checkbox"/>	A still image immediately after reading is displayed. The memory number (0 to 35) under which the image is stored is displayed in <input type="checkbox"/> . When reading moving objects, display freeze images.
Through	The image currently caught by the Camera is displayed. When reading is performed on through images, a delay due to the command input timing will occur before starting to load images. This delay is included in the reading time shown in the MON (monitor) and RUN mode.
Memory <input type="checkbox"/>	Saved images that were captured previously are displayed. Images that comply with the save condition (Only NG/All) are saved in memories 0 to 35. When backing up saved images in a PC or Memory Card, specify the Memory <input type="checkbox"/> .
Image 0	This is an image with 0.Image Adjust/Filtering implemented. The image read is the image after this filtering.
Image 1	This is the image used internally when 0.Image Adjust/Filtering retry is executed.
Image 2	This is the image used internally when 0.Image Adjust/Filtering retry is executed.

Changing Options

Items with an inverted triangle after them have a list of alternatives. The method for selecting the alternatives is given here.

The explanation given here uses the **Camera/Monitor** system setting as an example.

 Refer to page 181 (Sec.7).

1. Move the cursor to the item to be selected.
Select **Monitor** here.

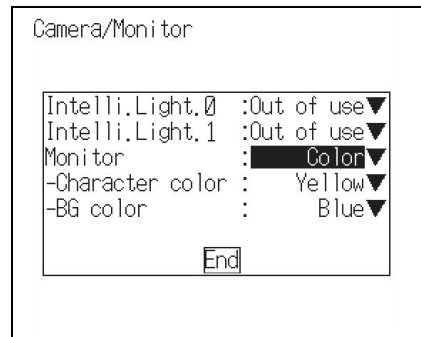

2. Press the **ENT** Key.

▼
The selections will be displayed.

3. Use the **Up/Down** Keys to move to the target position.

4. Press the **ENT** Key.

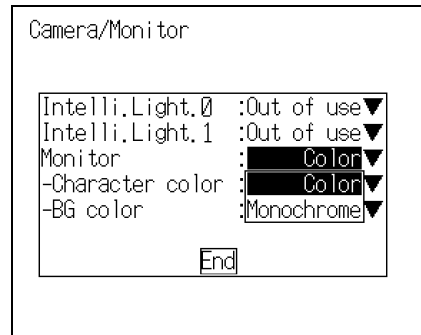

▼
The setting will be registered.

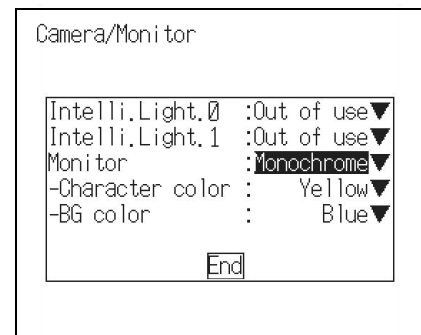

Inputting Values

This section explains how to input values when setting reading conditions or communications specifications.

The explanation given here uses the **Date/Time** system setting as an example.

 Refer to page 188 (Sec.7).

1. Move the cursor to the item whose value is to be changed.

2. Press the **ENT** Key.

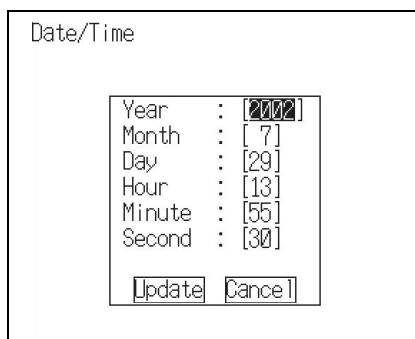

Date/Time

Year	:	[2002]
Month	:	[7]
Day	:	[29]
Hour	:	[13]
Minute	:	[55]
Second	:	[30]

[Update] [Cancel]

The cursor will change to a cursor the size of a single digit.

3. Move the cursor to the digit to be changed.
Left/Right Keys: To move the cursor left or right.

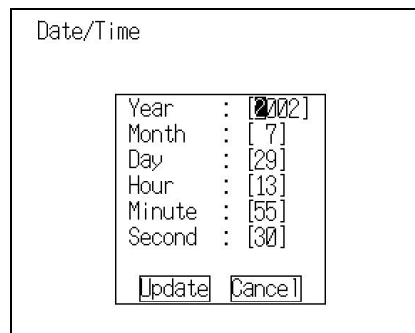

Date/Time

Year	:	[2]002
Month	:	[7]
Day	:	[29]
Hour	:	[13]
Minute	:	[55]
Second	:	[30]

[Update] [Cancel]

4. Change the value.

Up Key: To increase the value.

Down Key: To decrease the value.

5. Repeat these steps to change other values.
6. Press the **ENT** Key.

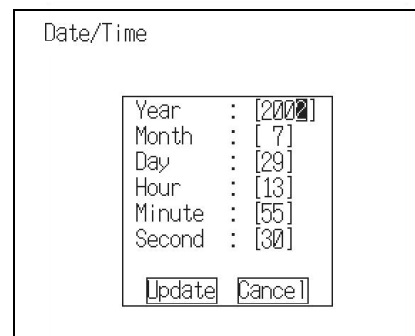

Date/Time

Year	:	[200]2
Month	:	[7]
Day	:	[29]
Hour	:	[13]
Minute	:	[55]
Second	:	[30]

[Update] [Cancel]

The values will be set.

Inputting Characters

This section explains how to input characters in file names, comments etc.

The software keyboard shown below is displayed on the screen where characters are input.

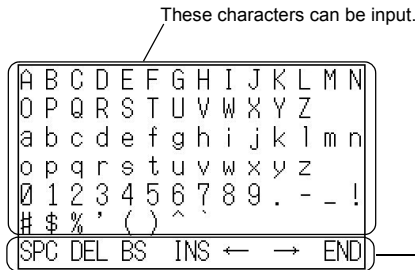

SPC	Insert a space.
DEL	Deletes 1 character to the right of the I cursor.
BS	Deletes 1 character to the left of the I cursor.
INS	Switches between insert (default)/overwrite.
←	Moves the I cursor to the left.
→	Moves the I cursor to the right.
END	Ends character input.

1. Move the cursor to the character to be input.

2. Press the **ENT** Key.

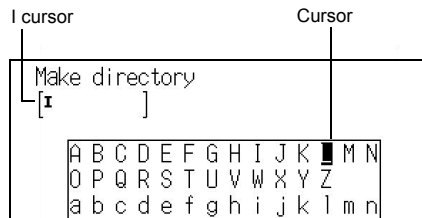

The character is set and the I cursor moves one space to the right.

3. Repeat these steps to input more characters.

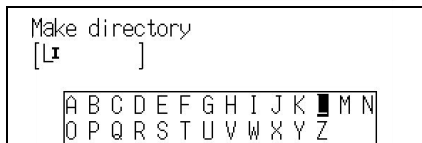

4. Once all required characters have been input, move the cursor to **END**.

5. Press the **ENT** Key.



The characters will be set.

Understanding Setting Operations

This section explains how to set reading conditions using Menus and the basic steps before starting readings.

step 1 Select the Code and Capture the Image

1. Move the cursor to **MON** (monitor) using the **Right Key** and press the **ENT** Key.



A list of modes will be displayed.

2. Select **SET**.

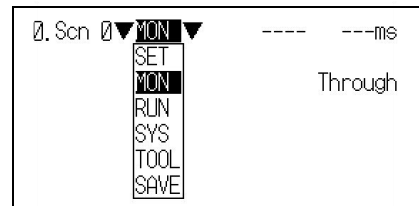

Enter the SET mode.

3. Select **DataMatrix** or **QRCode**.
The explanation here assumes that **DataMatrix** is selected.

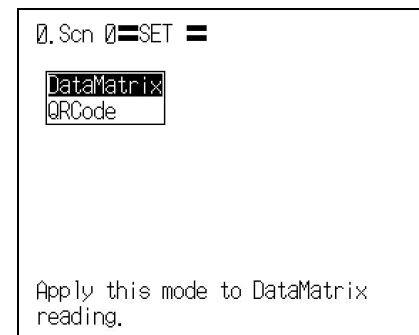

4. Press the **ENT** Key.

The setting items will be displayed.



To change the code to be read, press the **SHIFT + ESC** Keys.

CHECK! The screen in **3.** will return.

5. Press the **ESC** Key.

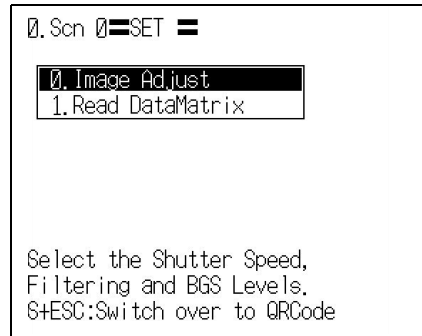

The image read from the camera will be displayed.

6. Check that the code of the reading object is displayed on the screen.

If it is not displayed, press the **SHIFT + Down** Keys to change the displayed screen to **Through** and then adjust the position so that the code of the object appears in the center of the screen.

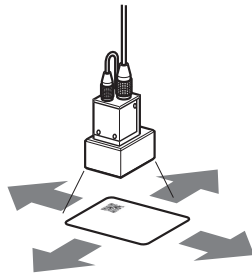
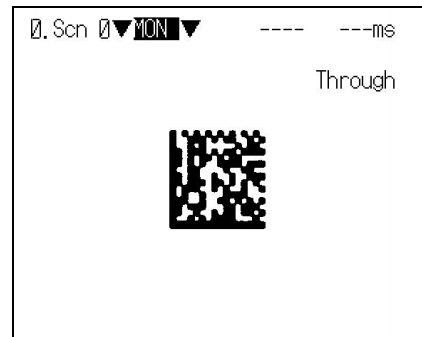

Adjust the object position.

7. Adjust the Camera Focus.

When using an F150-S1A-2D Camera

Adjust the focus by turning the focusing ring of the CCTV Lens.



Change the shutter speed when the object is moving quickly, causing the image to blur.

CHECK!



Refer to page 93 (Sec.5).

When using a Camera with an Intelligent Lighting

Since the lens has a fixed focal point, adjust the position of the camera by referring to the setting distance information in *SECTION 2 Installation and Connections* in order to focus it.



The light level can be adjusted from the V530-R160.

CHECK!



Refer to page 100 (Sec.5).

▼
This completes the preparations for capturing the image.

step 2 Set Reading Conditions

This section explains how to set the basic functions required for reading.



There are many other functions apart from these: for details, see *SECTION 5 Setting Reading Conditions*.

CHECK!



Refer to page 91 (Sec.5).

1 Entering the SET Mode

1. Move the cursor to **MON** (monitor) and press the **ENT** Key.

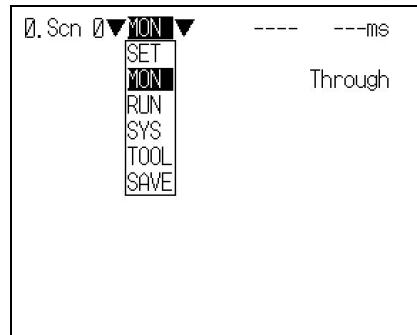

A list of modes will be displayed.

2. Move to **SET** using the **Up** Key and press the **ENT** Key.

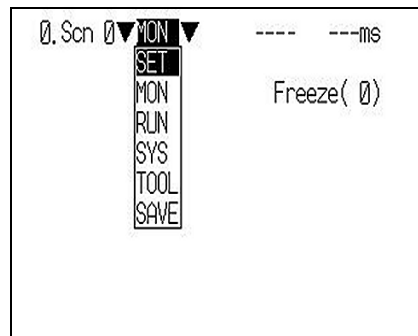

Enter the SET mode.



CHECK!

To change the code to be read, press **SHIFT + ESC** Keys.

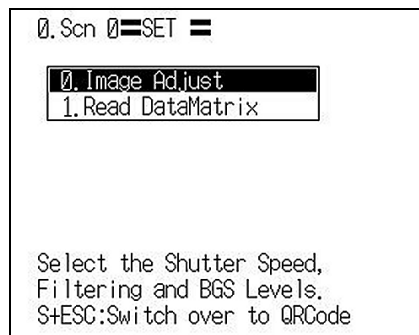

2 Selecting Shutter Speed

1. Select **0. Image Adjust**.



▼
The Image Adjust selections will be displayed.

2. Select **Shutter speed**.

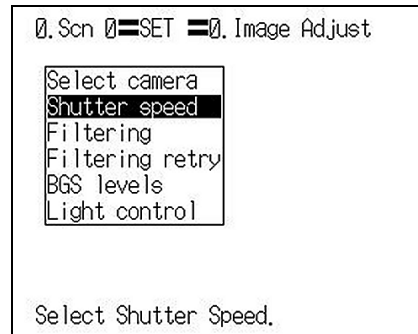

▼
The Shutter speed selections will be displayed.

3. Select the shutter speed according to the light level of the image.

Shutter speed



4. Press the **ENT** Key.

▼
The setting will be registered and the screen in **2.** will return.

3 Registering Models of Finder Pattern

Register an image of the finder pattern (the L-shape described by 3 of the corners) as the model. Use the teaching function for registration. Using the teaching function, a reading image is obtained, measurement is performed on this image, and based on the results of this measurement, parameters for reading conditions (symbol color, Right & Left reverse) are automatically determined. The teaching results can be checked or changed with **Code settings**.

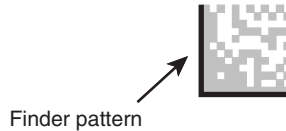

What is Black & White Reverse? Refer to page 284 (Sec.10).

What is Right & Left Reverse? Refer to page 284 (Sec.10).

When registering patterns, be sure to carry out reading by trigger input and complete teaching for each pattern registration. You cannot register patterns consecutively without performing teaching processing.
CHECK!

The ECC level is set automatically when the matrix size is selected.
CHECK!

Matrix size	ECC level
10 × 10 to 64 × 64 8 × 18 to 16 × 48	ECC200
9 × 9 to 25 × 25	ECC000-140

The object code can be read even if it is inclined.
Set the range for the angle of inclination.
CHECK! The wider the range, the longer the processing time will be.

Example: At $0^\circ \pm 30^\circ$:

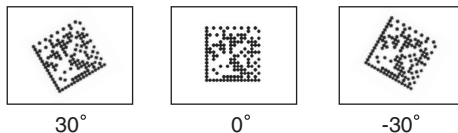

Reading is possible when the object is within the range -30° to 30° .

For the method of pattern registration when using QRCode : Refer to page 129 (Sec.5).
CHECK!

1. Select 1. Read DataMatrix.



To change the code to be read, press **SHIFT+ ESC** Keys.



▼
The initial screen for the DataMatrix reading will be displayed.

2. Select Pattern settings.

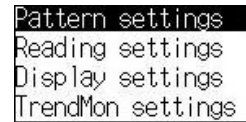

▼
The **Pattern list** will be displayed.

3. Select the pattern number to be registered.

Up/Down/Left/Right Keys: To move among pattern numbers.

The selected pattern number is indicated with a solid-line frame.

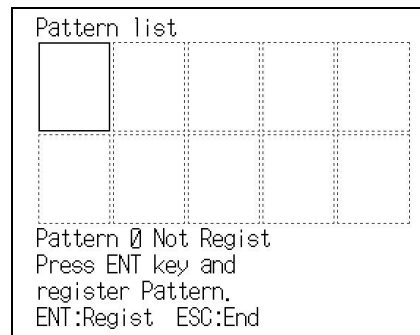

4. Press the ENT Key to validate the setting.

▼
The Pattern settings selections will be displayed.

5. Select Pattern registration.



The Pattern registration screen will be displayed.

6. Select the image to be registered by pressing the **SHIFT + Up** or **Down** Keys.
7. Press the **ENT** Key to validate the setting.



The Matrix Size selections will be displayed.

8. Select the Matrix Size.

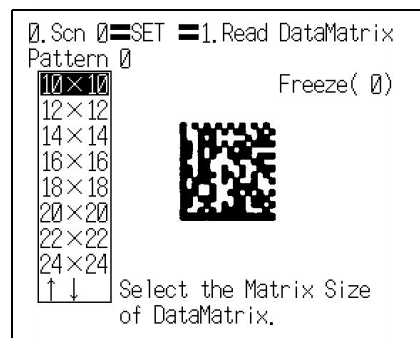

The Length of Finder Pattern setting screen will be displayed.

9. Select the first end point of the L shape.

Draw the L shape by matching it to the shape of the code.

Up/Down/Left/Right Keys: To move the cursor.
Shift + Up/Down/Left/Right Keys: To move the cursor 10 times faster.

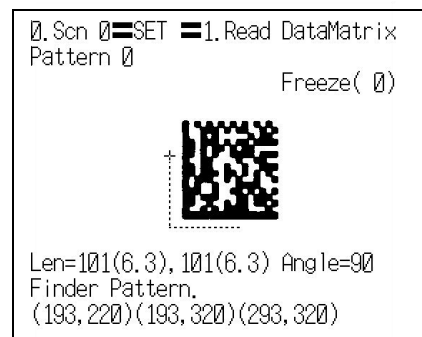

At the bottom left of the screen are displayed the length of the L shape, the number of pixels per cell (the numerical value in parentheses), the angle, and the coordinates of the three points. Adjust the field of vision so that there are at least 5 pixels per cell.

CHECK!



Refer to pages 46 to 48 (Sec.2).

 What is a pixel?  Refer to page 283 (Sec.10).

 What is a cell?  Refer to page 284 (Sec.10).

10. Press the **ENT** Key to validate the setting.

11. Specify the second end point and the third end point so that they fit the shape of the code.

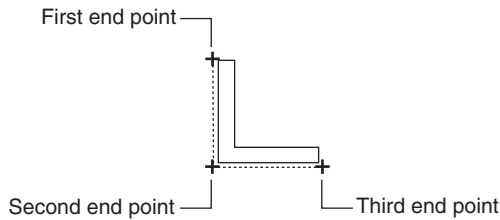

12. Press the **ENT** Key to validate the setting.

The selections for the direction of the code will be displayed.

13. Select the direction of a code whose pattern is registered and confirm it by pressing **ENT** Key.

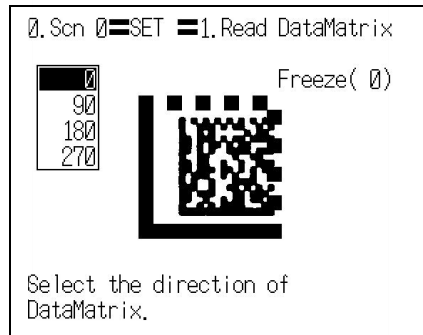
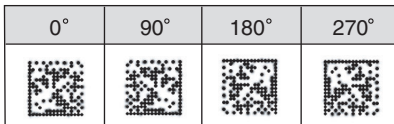

The selections for the permissible angle range will be displayed.

- 14.** Select the range of inclination for the code, and press the **ENT** Key.

Example: Selecting ± 45 when the direction of the code is 0°

Set a range of inclination of -45° to 45° .

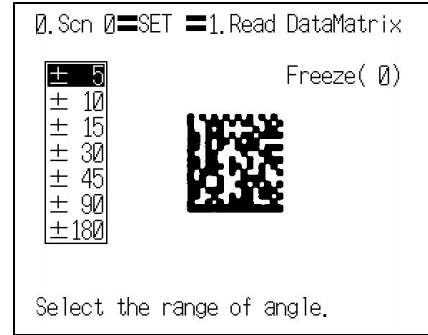
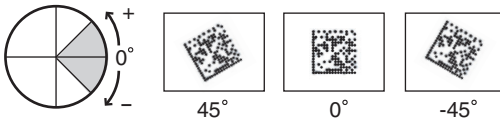

Since widening the angle increases the time it takes to read the code, set a range that is not too large but is sufficient.

CHECK!

The Pattern registration confirmation screen will be displayed.

- 15.** Press the **ENT** Key.

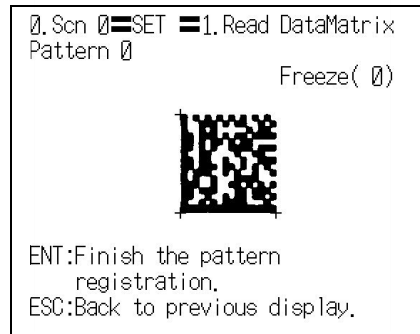

The setting will be registered and the screen in **5.** will return.

- 16.** Press the **ESC** Key four times.



The Monitor mode screen will return.

17. Press the **TRIG** Key to perform teaching.

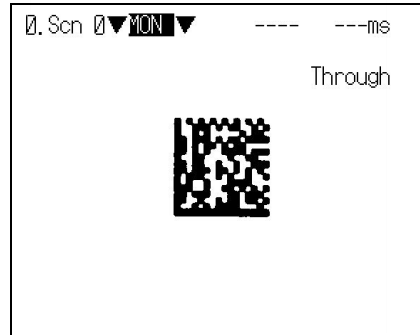

If the result of teaching is OK, the Symbol color, Right & Left reverse, and Matrix Size information is displayed and the pattern is registered. Repeat these steps to register multiple patterns.

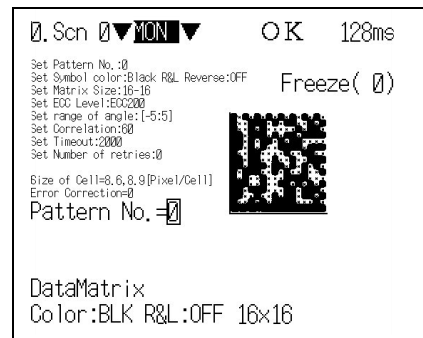

If the result of the teaching is NG, go to the screen at **3.** (pattern list screen), delete the pattern, adjust the camera focus, lighting and so on, then carry out pattern registration again.



If reading is performed successfully, the teaching function will automatically turn OFF. If the result of the reading is NG, the teaching function will stay ON. To turn the teaching function OFF, go to the screen in **3.** (pattern list screen). To redo pattern registration, enter **SET** mode and start the procedure again from **1.**

step 3 Perform Tests

Perform the reading under the conditions that have been previously set.

Adjust the reading conditions by referring to the result of the test. When a test is performed in the **MON** (monitor) mode, the test is completed internally by the V530-R160 and the reading judgements are not output to the host.

1. Press the **ESC** Key while the **SET** mode screen is displayed.



The Monitor mode screen will be displayed.

2. Press the **TRIG** Key.

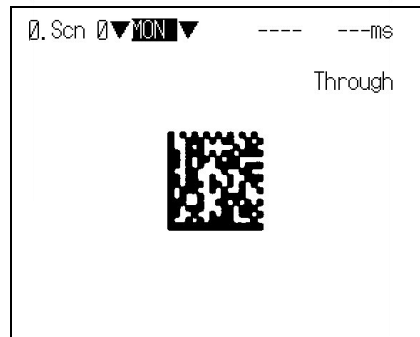

One reading will be executed and the reading judgements will be displayed on the screen.



CHECK! When the **TRIG** Key is pressed in the **RUN** mode, the reading judgement (in this case, ABCDE12345) will be output to the host.

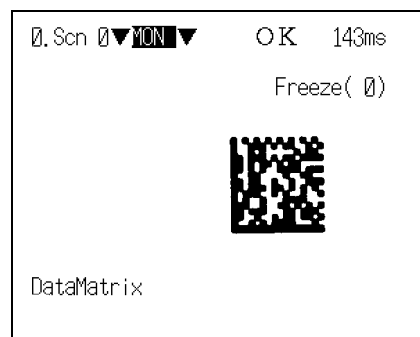

step 4 Start Reading

Enter the **RUN** mode to perform readings.

Reading judgements can be output to host devices via the serial interface.

For line operation, use this **RUN** mode.

1. Move the cursor to **MON** (monitor) and press the **ENT** Key.



A list of modes will be displayed.

2. Select **RUN**.

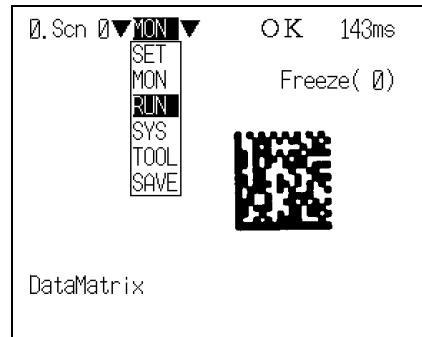

The RUN mode screen will be displayed.

3. Input a reading trigger.



Reading is performed.



Various commands can be input from a host device in addition to the trigger input.

Via the parallel I/O



Refer to page 194 (Sec.8).

Via the serial interface port using Normal communications



Refer to page 212 (Sec.8).

Via the serial interface port using Host Link communications



Refer to page 240 (Sec.8).



Reading judgements can be output to host devices via the serial interface.

Via the serial interface port using Normal communications



Refer to page 227 (Sec.8).

Via the serial interface port using Host Link communications



Refer to page 243 (Sec.8).



Read images can be stored.

Up to 35 images can be stored in memory. Once 35 images have been stored, the existing images will be overwritten in order starting with the oldest.

Move to **SYS/Image storing** and change the conditions for image storage.

To store NG images only, select **Only NG**, and to store images regardless of the reading result, select **All**.

Read images can also be backed up automatically to the Memory Card.

Turn ON **SYS/ Image storing /Store to MemCard**.



Refer to page 182 (Sec.7).



Reading can be repeated for stored images.

Display the desired stored image using the **SHIFT + Up/Down** Keys and press the **SHIFT + TRIG** Keys to execute reading.

Reading can also be repeated for freeze images without re-inputting the image using the **SHIFT + TRIG** Keys. By reading an image again after adjusting the reading conditions, you can check if the conditions are appropriate.



The light will gradually become dimmer as it is used, so adjust the reading conditions periodically.

The light dims about 20% in 1500 hours of use. (Applies to Intelligent Lighting)

step 5 Save Settings and Exit the V530-R160

Be sure to save the revised setting data to flash memory before turning OFF.

NOTICE

As the V530-R160 loads data from flash memory at startup, any new data will be lost if it is not saved to flash memory. The stored images cannot be saved to flash memory and are cleared when the power is turned OFF. The images must be backed up in the computer or the Memory Card if you want to save them long term.



Refer to page 149 (Sec.6).

1. The **MON** (monitor) mode or **RUN** mode screen will be displayed.

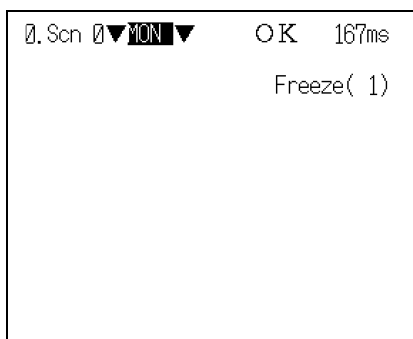

2. Move the cursor to **MON** or **RUN** and press the **ENT** Key.

The mode selections will be displayed.

3. Select **SAVE**.



The confirmation message will be displayed.

4. Select **Execute**.

NOTICE

Never input the RESET signal or turn OFF the power while saving or loading. Data may be lost, and the V530-R160 may not operate properly the next time it is started.

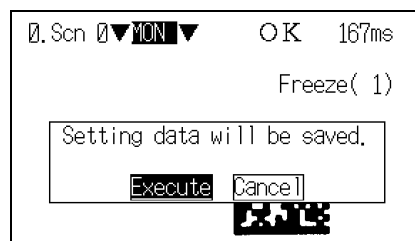



When saving has been completed, the screen in **1.** will return.

5. Turn OFF the power supply and exit the V530-R160.

SECTION 5

Setting Reading Conditions

Set the conditions for reading the code. This section explains how to adjust the image so that the code is caught clearly by the Camera, and the method for setting the DataMatrix and QRCode reading conditions.

 Adjusting the Image (Image Adjust)	92
 Setting Reading Conditions (DataMatrix)	104
 Setting Reading Conditions (QRCode)	129

Adjusting the Image (Image Adjust)

To ensure accurate and efficient reading, adjust the image so that the code is caught clearly by the Camera.



Within the same scene, even if the code reading settings (**Read DataMatrix**, **Read QRCode**) are changed, the settings relating to image input are retained.

CHECK!

Switching Cameras

Two cameras can be connected to one controller. The image from the Camera selected here is the one that is read. The setting on shipment from the factory is **Camera 0**.

1. Select **0. Image Adjust**.

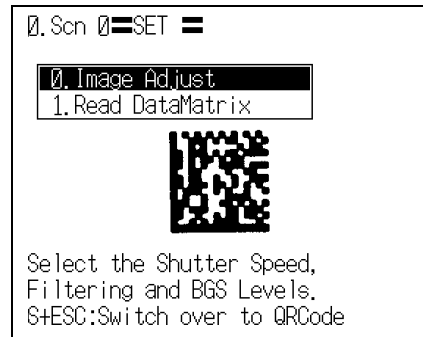

▼
The Image Adjust selections will be displayed.

2. Select **Select camera**.

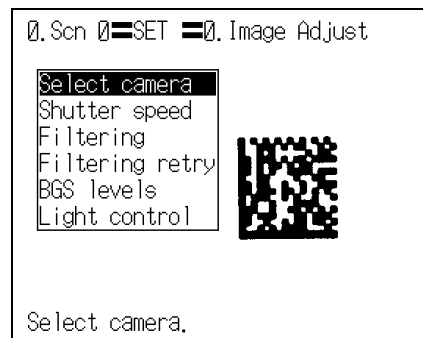

The Camera selections will be displayed.

3. Select **Camera 0** or **Camera 1**.
4. Press the **ENT** Key.

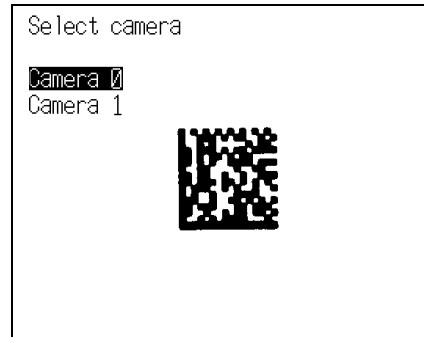

▼
The setting will be registered and the screen in 2. will return.

Shutter Speed

If the image is unsteady, adjust the shutter speed.

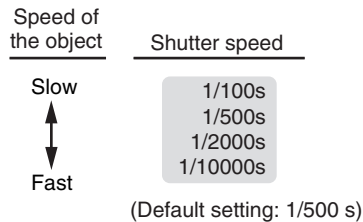

1. Select **0. Image Adjust/Shutter speed**.

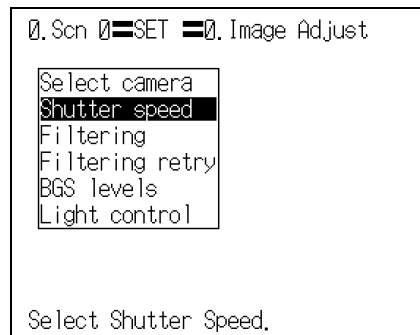

The Shutter speed selections will be displayed.

- 2.** Select an appropriate speed while viewing the image.
- 3.** Press the **ENT** Key.

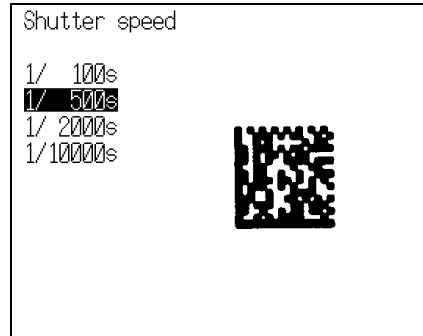

The setting will be registered and the screen in **1.** will return.

Filtering

The image read by the Camera can be manipulated to create an image that is easier to read by using the 5 filtering methods.

Select from the five methods: **Weak smoothing**, **Strong smoothing**, **Dilate**, **Erosion**, **Median**. When a selection is made with the cursor, the image after the processing is displayed on the monitor. Select the appropriate filtering while viewing the image.

Filtering	Target	Function
OFF	—	Filtering is not performed.
Smoothing*	Reading objects with slight surface irregularity	Reduces the irregularity through smoothing. (Select either weak or strong smoothing.)
Dilate	The dots (white cells) of the code are too small.	Has the effect of increasing the size of the dots when the cells are white and the background is black.
Erosion	The dots (black cells) of the code are too small.	Has the effect of increasing the size of the dots when the cells are black and the background is white.
Median	Reading objects with slight surface irregularity	Lessens dispersion in the image while maintaining its contours.

The asterisk (*) indicates the default setting.

Example:

When **Erosion** is executed

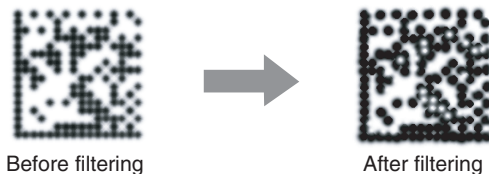



Filter size

Enables selection of the strength of the processing when an image is manipulated.

CHECK! Example: Effect of changing the filter size when executing **Erosion**

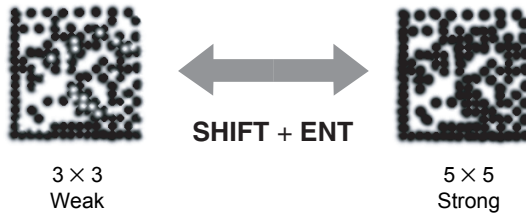

1. Select **0. Image Adjust/Filtering.**

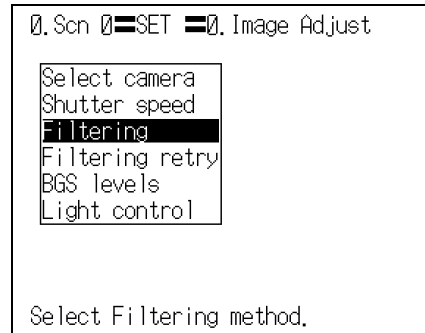

▼
The Filtering selections will be displayed.

2. Select an appropriate filtering method while viewing the image.

SHIFT + ENT Keys: To change the filter size.

3. Press the **ENT** Key.



▼
The setting will be registered and the screen in **1.** will return.

Filtering Retry

After **Filtering**, it is possible to add up to four more filtering steps (filter 1 to filter 4). These adjustments can enable more stable reading of the image. The controller executes the processing in order from filter 1. The filtering options that can be set are **Smoothing** and **Median**. Make the settings in order from filter 1.

Selection	Description
OFF*	Filtering is not performed.
Smoothing	For objects that have slight surface irregularity, this processing allows the surface irregularity to be lessened by gradation. Strong and Weak degrees of smoothing can be selected. The extent of the manipulation of the image can also be selected by selecting the filter size (3 × 3, 5 × 5).
Median	For objects that have slight surface irregularity, this processing allows the surface irregularity to be lessened while preserving the contour. The extent of the manipulation of the image can also be selected by selecting the filter size (3 × 3, 5 × 5).

The asterisk (*) indicates the default setting.

Example: When **Smoothing** (Filt. 1) is done after **Dilate** processing (Filtering)



When this function is set ON, the reading processing time is approximately 33 ms longer for one filter.

CHECK!

1. Select 0. Image Adjust/Filtering retry.

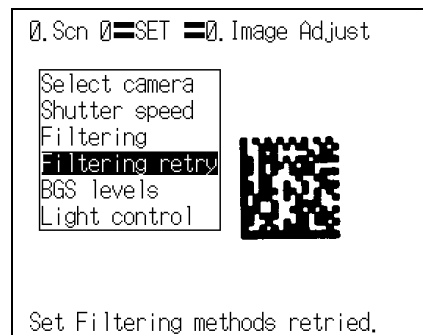

The setting screen for Filtering retry will be displayed.

2. Select the filtering method for **Filt.1**.
3. Press the **ENT** Key.

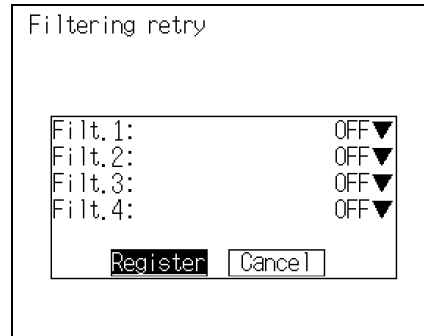

The filtering method will be saved.

4. Set the filtering methods for **Filt.2** to **Filt.4** according to your requirements, and then press the **ENT** Key.
5. Select **Register**.

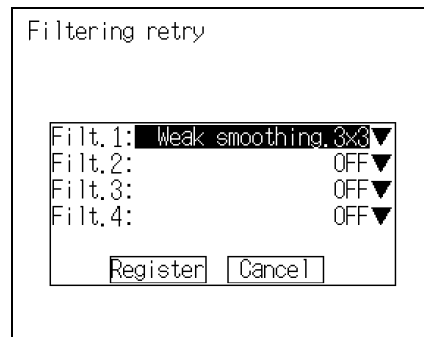

The setting will be registered and the screen in **1.** will return.

BGS Levels

This function suppresses the object's background to stabilize reading, eliminating noise and other disturbances.

Set the upper and lower limits of the BGS density while monitoring the image.

Densities lower than the set lower limit will be converted to 0 (i.e., areas with densities lower than that value will not be read), densities higher than the set upper limit will be converted to 255, and intermediate densities will be graded between 0 and 255. In other words, only the areas with densities between the set lower and upper limits will be read.

Example: Lower limit set to 150 and upper limit set to 220

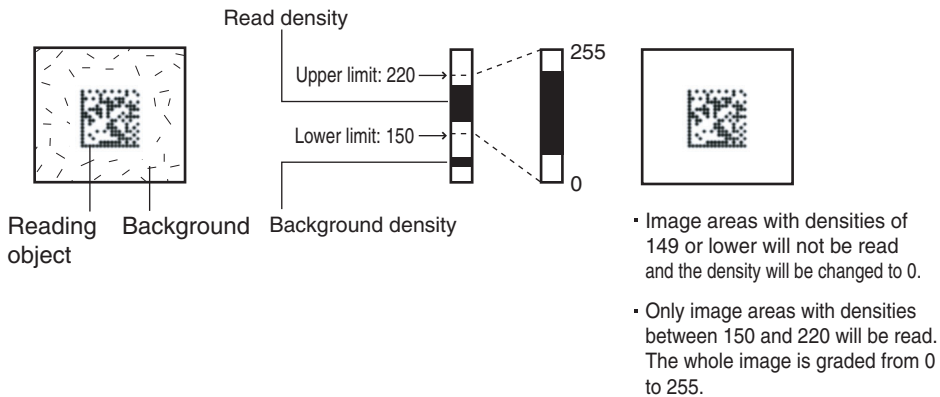

1. Select 0. Image Adjust/BGS levels.

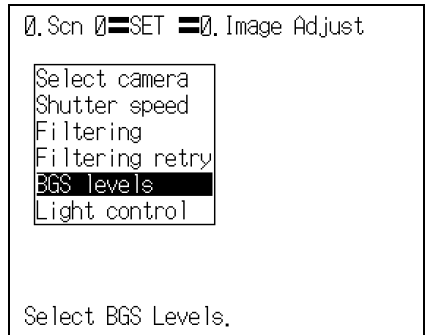

The BGS levels setting screen will be displayed.

2. Move the cursor to the upper value and use the **Left** and **Right** Keys to adjust the value.

Right Key: To increase the lowest digit by one.

SHIFT + Right Keys: To increase the value 10 times faster.

Left Key: To decrease the lowest digit by one.

SHIFT + Left Keys: To decrease the value 10 times faster.

3. Use the same method to change the lower value.

4. Select **OK**.

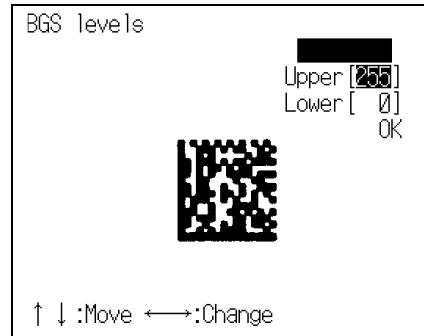

▼
The setting will be registered and the screen in **1.** will return.

Light Control

When a Camera with an Intelligent Lighting is connected, the light level can be adjusted from the V530-R160. Change the settings in the **SYS/Camera/Monitor** settings menu in advance to indicate that a Camera with an Intelligent Lighting is being used.



Refer to page 181 (Sec. 7).



If the shutter speed is 1/10000s, adjustment up to light level 2 is possible.

CHECK!

The Intelligent Lighting is pulsed in synchronization with the shutter trigger, and the light level can be adjusted by changing the width of this pulse.

If the light level is set to the maximum of 7, the light ON pulse width is approximately 450 μ s, and this more or less corresponds to the shutter period when the shutter speed is 1/2000s. Therefore, if the shutter speed is 1/10000s, and the light level is set to 2 or higher, the setting may be ineffective (the brightness may not change).

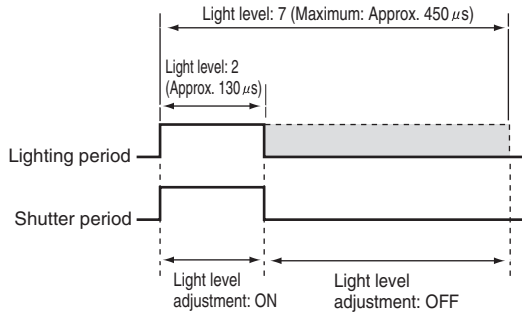

■ Light Control Screen

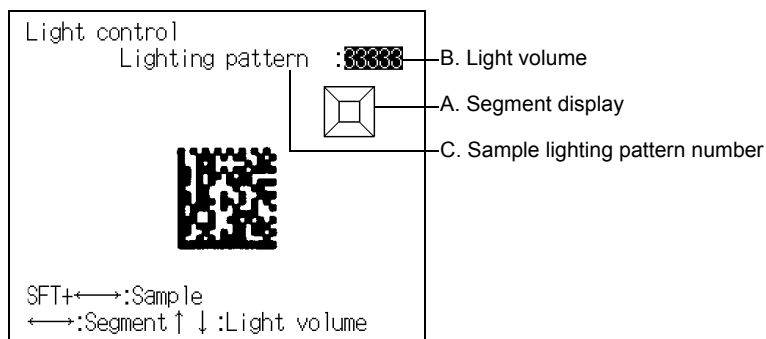

A. Segment display

Lighting can be adjusted in 5 areas.



The reading points are displayed with thick lines. The brightness depends on the set light level.

CHECK!



Refer to page 102.

B. Light volume

The light level setting for each area is shown in a separate digit of the 5-digit number. The light level settings range from 0 to 7; a value of 0 is OFF and 7 is the maximum brightness.

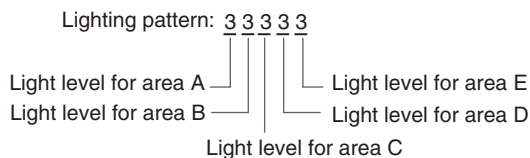

C. Sample lighting pattern number

There are 15 sample lighting patterns registered in the V530-R160.



Refer to page 102.

■ **Method 1: Using a Sample Lighting Pattern**

There are 15 sample lighting patterns registered, so the lighting pattern can be selected just by switching through the pattern numbers and determining which pattern gives the sharpest image. The sample pattern number can be switched by pressing the **SHIFT** Key together with the **Left** or **Right** Key.

Pat-tern No.	Light level	Pat-tern No.	Light level	Pat-tern No.	Light level	Pat-tern No.	Light level	Pat-tern No.	Light level
1	50000 	4	07070 	7	22727 	10	00070 	13	52222
2	03333 	5	27272 	8	07000 	11	00007 	14	17777
3	07777 	6	00707 	9	00700 	12	51111 	15	27777

- ... OFF
- ... Lit (Maximum brightness)

■ **Method 2: Adjusting Light Levels by Segment**

The light level for each area can be set independently between 0 and 7. 0 is OFF and 7 is the brightest. After selecting one of the sample patterns, the light level in each area can be fine-tuned if necessary. Select the desired area with the **Left/Right** Keys and adjust the area's light level with the **Up/Down** Keys. The following diagrams show the order in which the areas are selected with the **Left/Right** Keys.

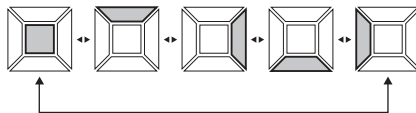

1. Select **0. Image Adjust/Light control**.



▼
The setting screen for Light control will be displayed.

2. Switch the sample lighting pattern number using the **SHIFT + Left/Right** Keys.



CHECK!

For fine adjustment of light levels, move to the desired digit using the **Right** and **Left** Keys and adjust the light level using the **Up** and **Down** Keys.

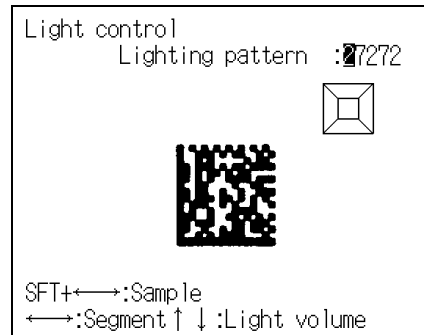

3. Press the **ENT** Key.

▼
The setting will be registered and the screen in **1.** will return.

Setting Reading Conditions (DataMatrix)

Set the reading conditions to suit the code of the reading object.
The explanation here deals with the settings for DataMatrix.

Pattern Settings

A finder pattern image is registered in advance, then when reading is executed a search is conducted for an image pattern similar to the input image in order to locate the code.

 What is a pattern search?  Refer to page 285 (Sec.10).

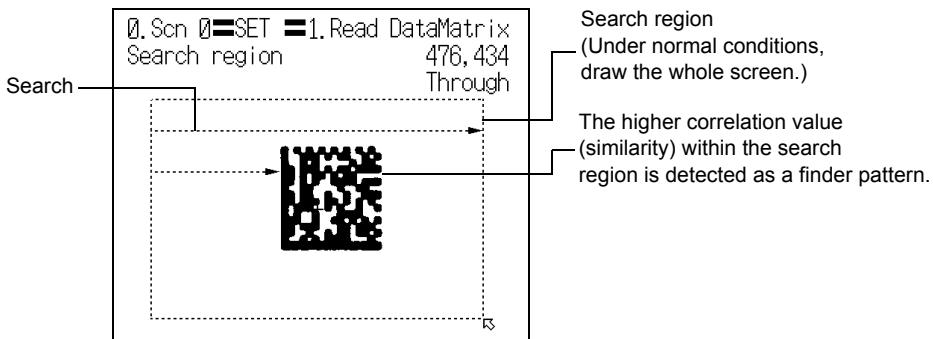

■ Pattern Registration

The finder pattern image is registered as a pattern.

Up to ten patterns can be registered for one scene, and **Code Settings** and **Search Region** are set for each of these patterns. Registering multiple patterns enables reliable reading even if there is dispersion in the dot spacing and printing quality. In addition, if codes with different matrix sizes and symbol colors are registered as patterns, multiple codes can be read in one scene. This makes scene changes unnecessary.

For details on the registration method, see *SECTION 4 Basic Operations step2 Set Reading Conditions*.

 Refer to page 79 (Sec.4).

Up to 10 patterns can be registered.

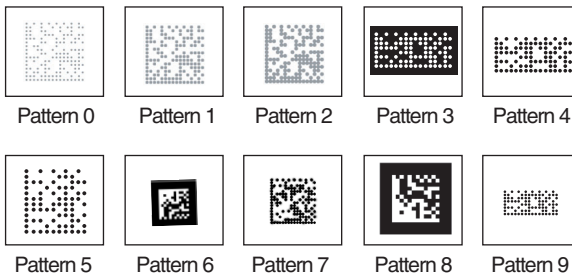

Multiple pattern registrations for a single code with dispersion, or pattern registration of codes with different matrix sizes or symbol colors



DataMatrix and QRCode cannot be mixed in pattern registrations.



When registering patterns, ensure a margin of at least one cell around the code.



Use the teaching function for pattern registration.

When registering patterns, be sure to carry out reading by trigger input and complete teaching for each pattern registration. You cannot register patterns consecutively without performing teaching processing.

The following setting information for pattern registration is displayed on the **Pattern list** screen.

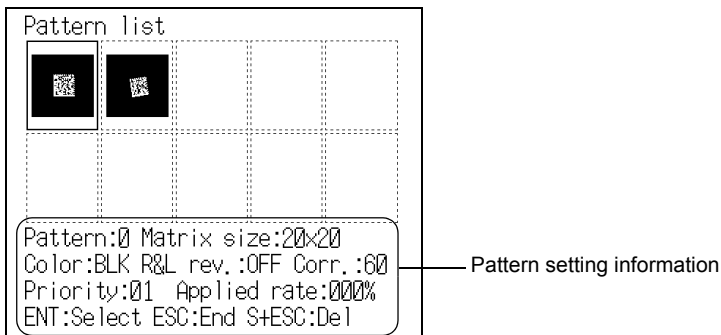

Item	Description
Pattern	Selected pattern number
Matrix size	Matrix size
Color	Symbol color of the pattern
R&L rev.	Execution/non-execution of pattern Right & Left reverse
Corr. (Correlation)	Pattern correlation value
Priority	Pattern sequence used when reading  Refer to page 113.
Applied rate	Applied rate of the pattern $\text{Applied rate} = \frac{\text{Number of times a pattern is used}}{\text{Total reads}^*}$ <p>* The maximum number of reads is the most recent 10000.</p>



To register a pattern again or register a new pattern, select the pattern number, then press the **ENT** Key, and go to the **Pattern registration** screen.



Refer to page 82 (Sec.4).

- To delete a pattern

1. Select the pattern number of the pattern that you want to delete from the **Pattern list** screen.

Up/Down/Left/Right Keys: To move among pattern numbers.

The selected pattern number is indicated with a solid-line frame.

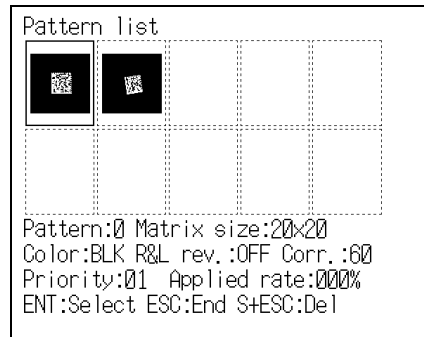

2. Press the **SHIFT + ESC** Keys.

▼
The confirmation message will be displayed.

3. Select **Execute**.



▼
The pattern is deleted, and the screen in **1.** will return.

Code Settings

Set the conditions to apply in pattern searches.

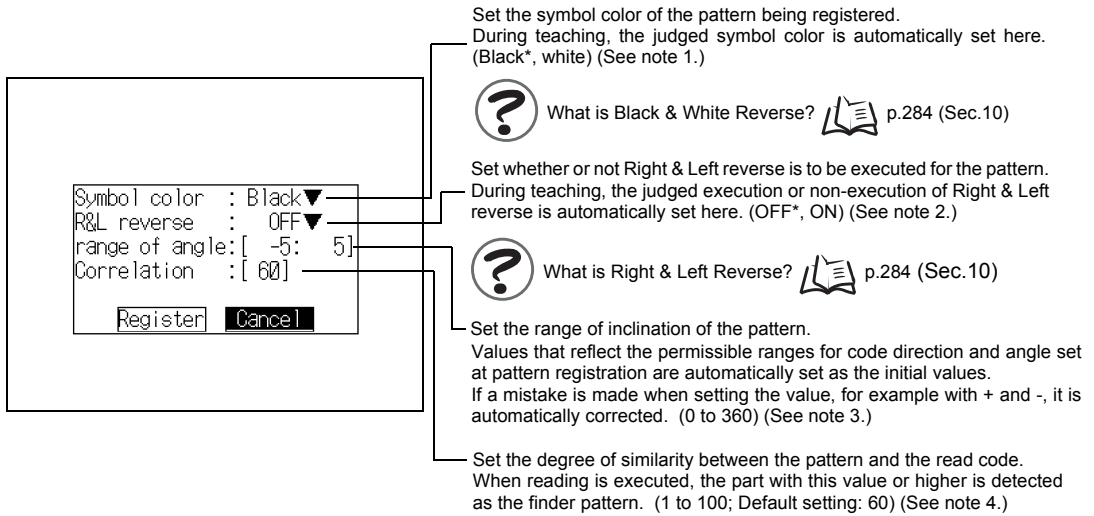

Set the symbol color of the pattern being registered. During teaching, the judged symbol color is automatically set here. (Black*, white) (See note 1.)

What is Black & White Reverse? p.284 (Sec.10)

Set whether or not Right & Left reverse is to be executed for the pattern. During teaching, the judged execution or non-execution of Right & Left reverse is automatically set here. (OFF*, ON) (See note 2.)

What is Right & Left Reverse? p.284 (Sec.10)

Set the range of inclination of the pattern. Values that reflect the permissible ranges for code direction and angle set at pattern registration are automatically set as the initial values. If a mistake is made when setting the value, for example with + and -, it is automatically corrected. (0 to 360) (See note 3.)

Set the degree of similarity between the pattern and the read code. When reading is executed, the part with this value or higher is detected as the finder pattern. (1 to 100; Default setting: 60) (See note 4.)

The asterisk (*) indicates the default setting.

Note 1: Symbol color



Black:
When black is printed on a white background

White:
When white is printed on a black background

Note 2: R&L reverse

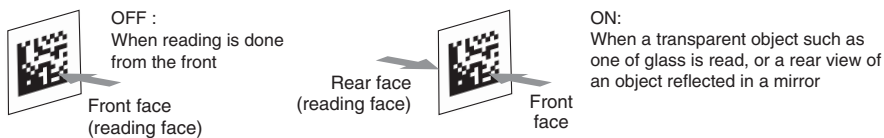

OFF:
When reading is done from the front

ON:
When a transparent object such as one of glass is read, or a rear view of an object reflected in a mirror

Front face (reading face) Rear face (reading face) Front face

Note 3: Range of angle

Example: When the code direction is 0° and the permissible range of the angle is ±30°, -30:30 is automatically set. Reading is possible within a range of inclination of -30° to 30°.

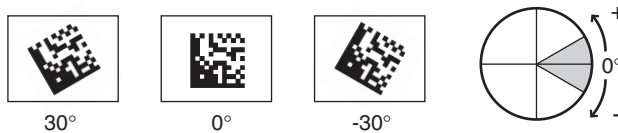

30° 0° -30°

Note 4: Correlation

Example: When the correlation value is 60.

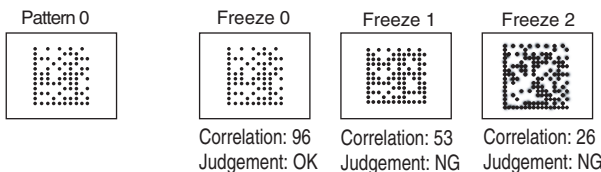

Pattern 0	Freeze 0	Freeze 1	Freeze 2
	Correlation: 96 Judgement: OK	Correlation: 53 Judgement: NG	Correlation: 26 Judgement: NG

1. Select the pattern number of the pattern that you want to set on the **Pattern list** screen.

Up/Down/Left/Right Keys: To move among pattern numbers.

The selected pattern number is indicated with a solid-line frame.

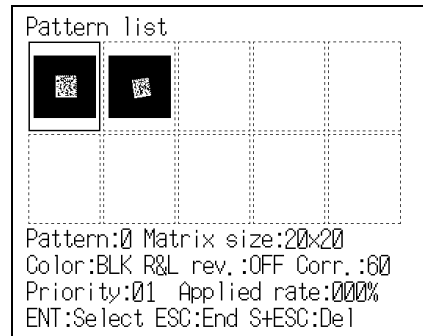

2. Press the **ENT** Key.

▼
The Pattern settings selections will be displayed.

3. Select **Code settings**.

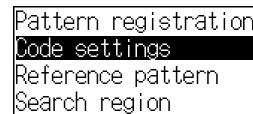

▼
The setting items will be displayed.

4. Make the settings for each item.

5. Select **Register**.



▼
The setting will be registered and the screen in **3.** will return.

■ Reference Pattern

The registered pattern is displayed on the monitor screen and can be checked. After performing pattern registration, always compare the pattern with a reference and check if the finder pattern has been registered correctly.

1. Select the pattern number of the pattern that you want to refer to on the **Pattern list** screen.

Up/Down/Left/Right Keys: To move among pattern numbers.

The selected pattern number is indicated with a solid-line frame.

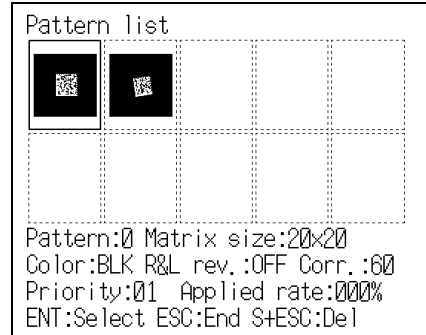

2. Press the **ENT** Key.

▼
The Pattern settings selections will be displayed.

3. Select **Reference pattern**.

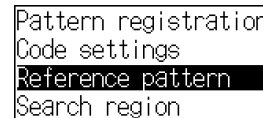

▼
The **Reference pattern** screen will be displayed. Detailed information about the pattern will be displayed at the bottom of the screen.



For information on detailed information about patterns, refer to page 106.



CHECK!

In order to improve the accuracy of detection of the finder pattern, a part of the timing pattern is also registered for the pattern.

4. Press the **ESC** Key to leave this screen.

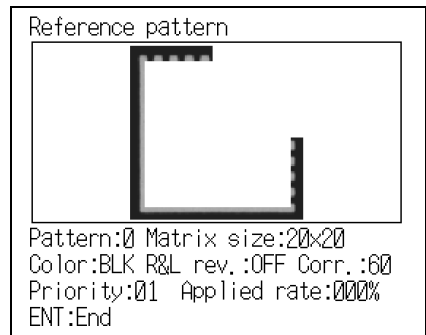

▼
The screen in **3.** will return.

■ Search Region

Specify the range within which the pattern search is to be conducted.

1. Select the pattern number of the pattern that you want to set on the **Pattern list screen**.

Up/Down/Left/Right Keys: To move among pattern numbers.

The selected pattern number is indicated with a solid-line frame.

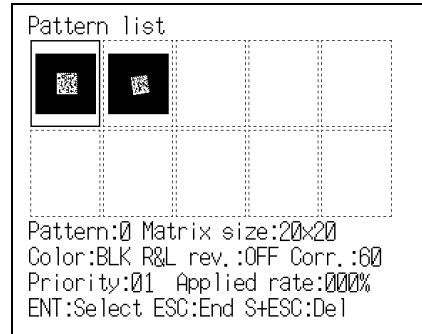

2. Press the **ENT** Key.

▼
The Pattern settings selections will be displayed.

3. Select **Search region**.



▼
The Search region setting screen will be displayed.

4. The search region is depicted as a rectangle.

Up/Down/Left/Right Keys: To move the cursor.
ENT Key : To confirm.



▼
When you set the bottom right coordinates the search region is confirmed and the screen in **3.** will return.

Reading Settings

Set the conditions for executing DataMatrix reading.

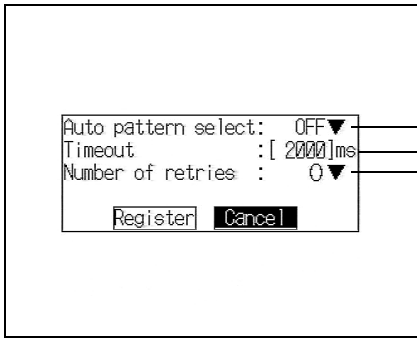

The asterisk (*) indicates the default setting.

Select whether or not there are to be automatic substitutions in the pattern comparison order in accordance with past frequencies. (OFF*, ON)



Refer to page 113.

Set the timeout time for reading processing during the reading of one image.

If "0" is set, the timeout time setting is invalid. (0, 100 to 10000 ms, Default setting: 2000 ms)

Select the number of retries to be made if the reading is NG. (0* to 9)

1. Select 1. Read DataMatrix.

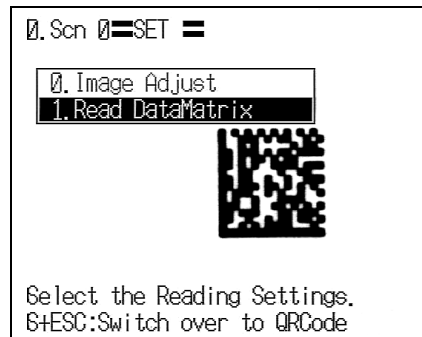

The initial screen for the DataMatrix reading will be displayed.

2. Select Reading settings.

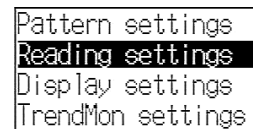

The setting items for reading condition setting will be displayed.

3. Make the settings for each item.

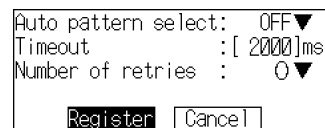

4. Select Register.

The setting will be registered and the screen in 2. will return.

■ Auto Pattern Select

If multiple patterns are registered, the controller references the patterns in sequence starting from pattern 0, and checks them by comparison against the read code.

If ON is set for this function, the controller first references the pattern used immediately before, then references the rest in order of diminishing frequency of use.

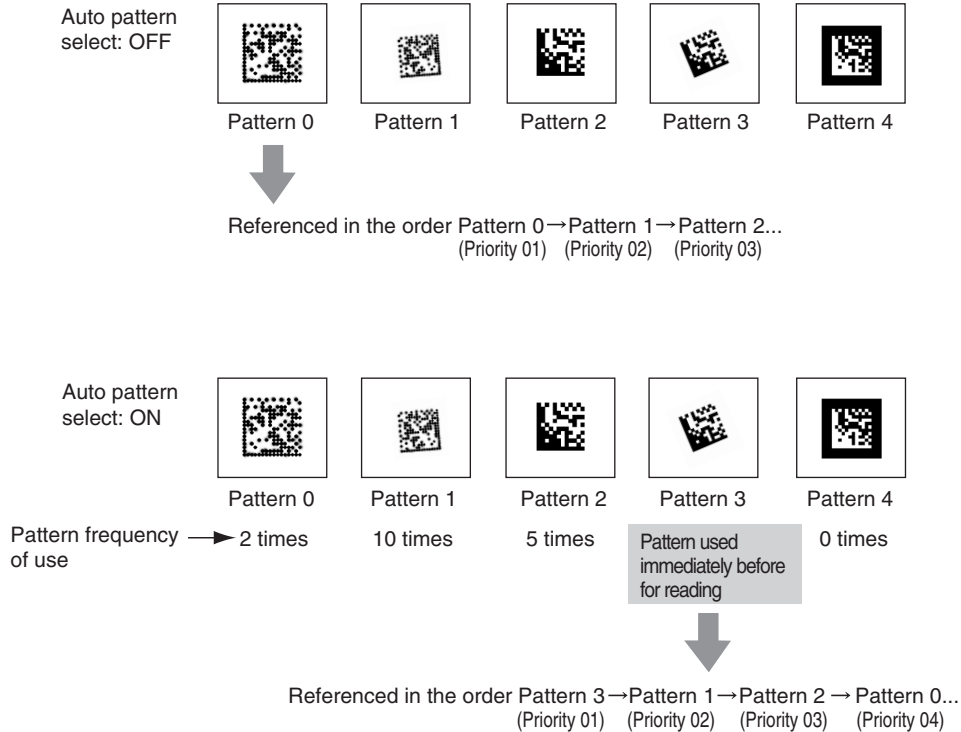

The order of priority of the patterns can be confirmed on the Pattern list screen.

CHECK!



Refer to pages 106 and 135.



When the first reading starts (when the pattern frequency of use is 0), the controller starts referencing from pattern 0.

CHECK!

When a registered pattern is deleted, the frequency of use of the relevant pattern is cleared.

Note also that if the controller power is switched OFF without saving the setting data, the pattern frequency of use information is cleared. If the setting data has been saved, the frequency of use information is retained.

Display Settings

Set the contents displayed in **MON** (monitor) mode and **RUN** mode.

If you increase the number of monitor display items, processing time increases proportionately.

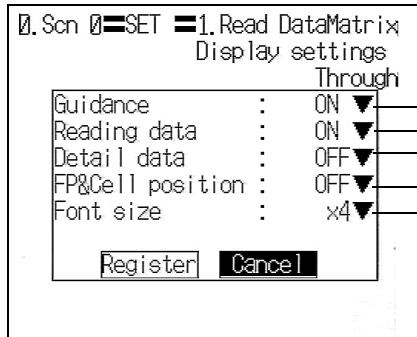

Set whether or not guidance is displayed at the bottom of the screen. (ON*, OFF)



Refer to page 116.

Specifies whether or not to display reading data on the screen. (ON*, OFF)



Refer to page 116.

Specifies whether or not to display the code's detailed data on the screen. (ON*, OFF)



Refer to page 116.

Set whether or not the position of the finder pattern and cell erroneous recognition positions are to be displayed. (ON*, OFF)



Refer to page 118.

Specifies the font size that will be used when reading data is displayed on the screen. (Standard, x 4 *)

The asterisk (*) indicates the default setting.

1. Select 1. Read DataMatrix.

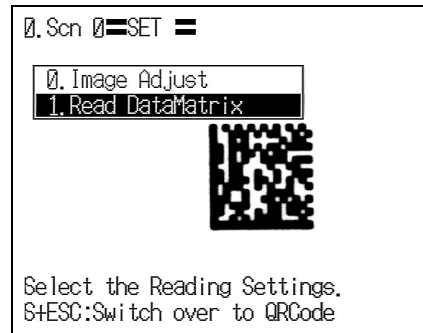

The initial screen for the DataMatrix reading will be displayed.

2. Select Display settings.

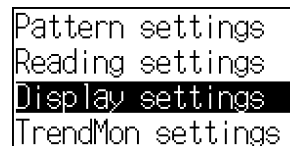

The display setting items will be displayed.

3. Make the settings for each item.

4. Select **Register**.

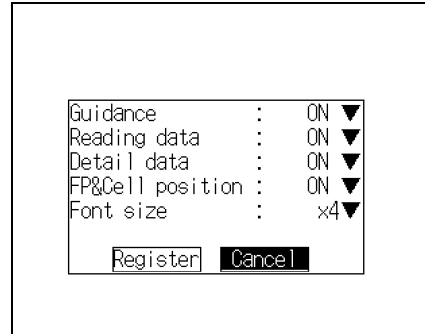

▼
The setting will be registered and the screen in **2.** will return.

■ Guidance

Displays explanations of the selected items and instructions on subsequent operations.

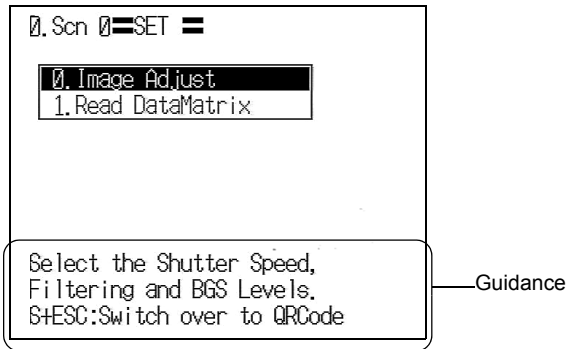

■ Reading Data

The read data is displayed. If the reading result is NG, the error code is displayed.

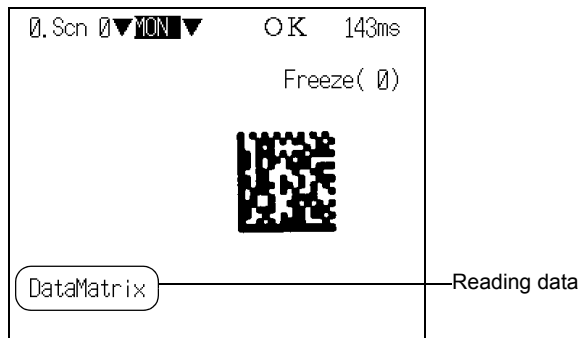

■ Detail Data

The settings, number of pixels (cell size), etc., for the read code are displayed. The data displayed differs according to the type of code.

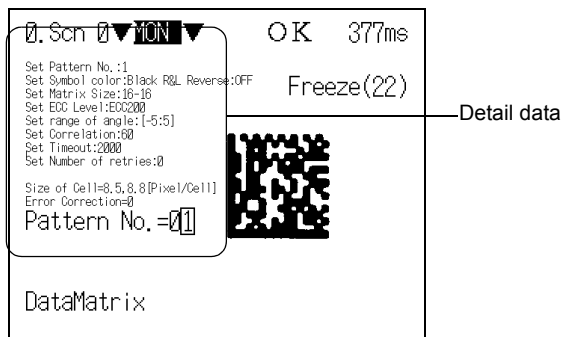

▪ **DataMatrix**

Item	Description
Set: Pattern No.	Displays the pattern number currently being used.
Set: Symbol color	Displays the Symbol color setting.
Set: R&L reverse	Displays the Right & Left reverse setting.
Set: Matrix size	Displays the Matrix size setting.
Set: ECC level	Displays the ECC level automatically recognized from the matrix size.
Set: Range of angle	Displays the reading angle setting.
Set: Correlation	Displays the correlation value.
Set: Timeout	Displays the Timeout time setting.
Set: Number of retries	Displays the Number of retries setting.
Size of Cell	Displays the pixel/cell contents read from the code.
Error Correction	Displays the number of error corrections on reading.
Pattern No.	Displays the registered pattern numbers. If the reading result is OK, the used pattern number is displayed enclosed in a box. If the reading result is NG, the used pattern number is highlighted.

▪ **QRCode**

Item	Description
Set: Pattern No.	Displays the pattern number currently being used.
Set: Symbol color	Displays the Symbol color setting.
Set: R&L reverse	Displays the Right & Left reverse setting.
Set: Version	Displays the Version setting.
Set: Range of angle	Displays the reading angle setting.
Set: Correlation	Displays the correlation value.
Set: Timeout	Displays the Timeout time setting.
Set: Number of retries	Displays the Number of retries setting.
Size of Cell	Displays the pixel/cell contents read from the code.
Error Corrections	Displays the number of error corrections on reading.
Pattern No.	Displays the registered pattern numbers. If the reading result is OK, the used pattern number is displayed enclosed in a box. If the reading result is NG, the used pattern number is highlighted.

■ FP & Cell Position

A cross-hair cursor is displayed at the position of the finder pattern (FP) and positions recognized as cells.

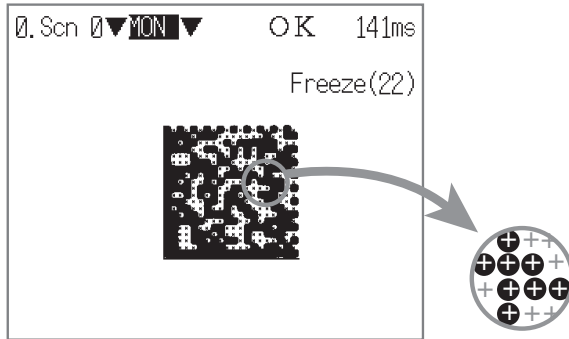

If a color monitor is used, cell recognition positions are indicated as shown below:

CHECK!

- Black cell portion ••• Green
- White cell portion ••• Red

Trend Monitor Settings

The transition over time of the “pattern correlation value” and contrast between the “code and background” can be represented in graph form for each scene (maximum of 1000 scenes). Changes in the shape of the code and the trend in changes in the lighting status can be checked by monitoring. This helps prevent multiple occurrences of defective items, and analyze the cause when NG results occur.

The changes in correlation value and contrast over time are displayed in graph form.

The most recent 1000 reading results are saved.

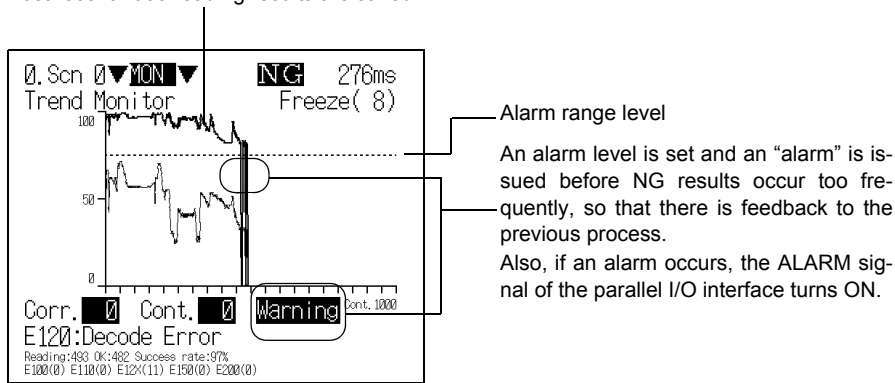

• Corr. (Correlation)

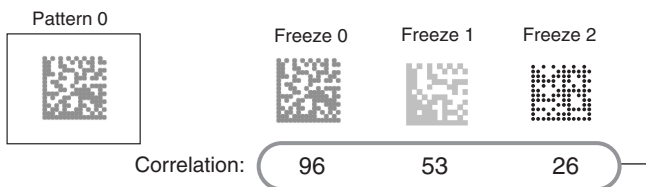

• Cont. (Contrast)

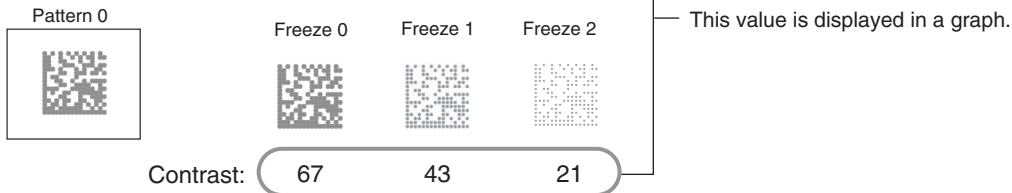

■ **Select the Object whose Data is to be Displayed by the Trend Monitor (Object of Monitoring)**

Sets the data displayed on the trend monitor when reading is executed.

Scn SET 1. Read DataMatrix
 Object of monitoring

Success rate : ON▼
 Correlation : ON▼
 -Warning level : [60]
 Contrast : ON▼
 -Warning level : [65]
 End

Select whether or not the reading history is displayed when reading is executed. (OFF*, ON)
 Refer to page 124.

Select whether or not the correlation value between the read code and the pattern is displayed. This allows you to detect changes in the status of the code. (OFF*, ON)

Set the alarm range for the correlation value. If the correlation value is less than or no higher than the value set, the **Warning** indication on the screen is highlighted. (0 to 100; Default setting: 60) (See note 1.)

Select whether or not the status of the contrast between the read code and its background is displayed. If the contrast is low, reading is not reliable. Adjust the lighting and the reading conditions. (OFF*, ON)

Set the alarm range for contrast.
 If the contrast is less than or no higher than this value, the **Warning** indication on the screen is highlighted. (0 to 100; Default setting: 0) (See note 1.)

The asterisk (*) indicates the default setting.

Note 1:

If the value is less than or no higher than the value set for the alarm range level, the measured value, and **Warning** on the screen, are highlighted.

Alarm range level

0. Scn MON NG 276ms
 Trend Monitor Freeze(8)

Corr: Cont.: Warning cont. 1000

E120:Decode Error
 Reading:483 OK:482 Success rate:97%
 E100(0) E110(0) E12X(11) E150(0) E200(0)

If the measurement is less than or no higher than the set alarm range, an alarm occurs.



When an alarm occurs, the ALARM signal of the parallel I/O interface turns ON.

1. Select **1. Read DataMatrix.**

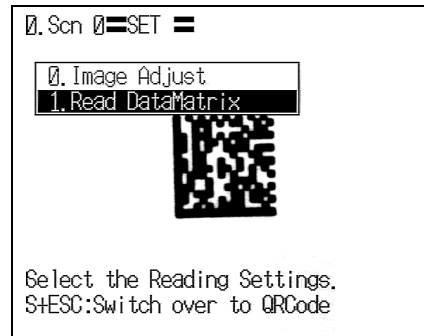

▼
The initial screen for the DataMatrix reading will be displayed.

2. Select **TrendMon settings.**

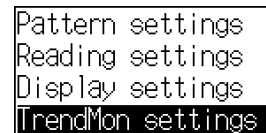

▼
The Trend Monitor selections will be displayed.

3. Select **Object of monitoring.**



▼
The setting items will be displayed.

4. Set the items displayed on the Trend Monitor screen.

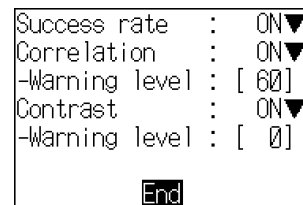

5. Select **End.**

▼
The setting will be registered and the screen in **3.** will return.

■ **Display the Trend Monitor**

Perform actual reading and display the trend monitor.

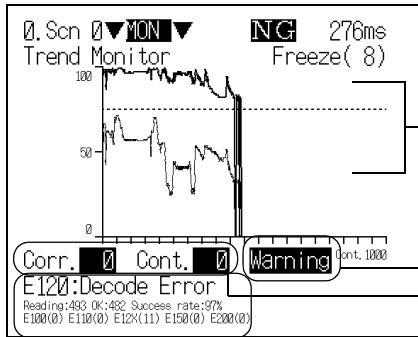

The measurement values are displayed in a graph.

Displayed when the measured value falls below the alarm level.

The most recent measured value is displayed.

When an alarm or reading NG occurs, the measured value is highlighted.

The read data and reading history are displayed.

If the reading result is NG, an error code is displayed.

Refer to page 253 (Sec.9).



When using a color monitor, the data is displayed in the colors indicated below:

Corr. (Correlation) ••• Red

CHECK! Cont. (Contrast) ••• Green

1. Enter **RUN** mode to perform readings.

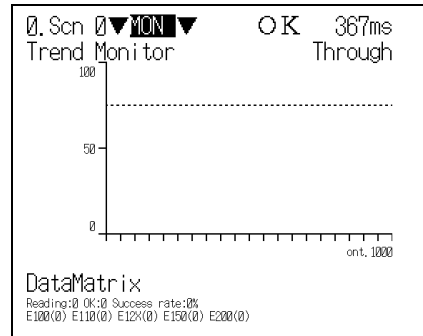

▼
A graph is displayed



Press the **SHIFT + ENT** Keys to clear the history data.

CHECK!

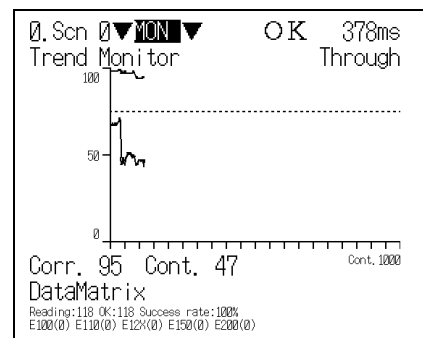



RUN mode screen

Use the **SHIFT + Right** or **Left** Keys to switch among the three types of screen.

(1) Trend Monitor

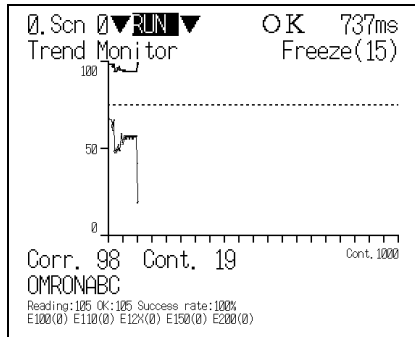

(2) Statistic Data

0. Scn 0 ▼ RUN ▼ ○ K 737ms

Statistic Freeze(15)

	Corr.	Cont.
Maximum	99	67
Minimum	94	18
Average	95	55
Measure count:	105	
NG count	0	
Warning count:	0	

OMRONABC

Reading:105 OK:105 Success rate:100%
E100(0) E110(0) E12X(0) E150(0) E200(0)

(3) Detail Data

0. Scn 0 ▼ RUN ▼ ○ K 737ms

Set Pattern No.:2
Set Symbol color:White R/L Reverse:OFF
Set Matrix Size:14-14
Set EOC Level:EOC200
Set range of angle:[175:185]
Set Correlation:60
Set Timeout:2000
Set Number of retries:0

Size of Cell=5, 0, 5, 1 [Pixel/Cell]
Error Correction=0

Pattern No. = 0 12 Through

OMRONABC

Reading:105 OK:105 Success rate:100%
E100(0) E110(0) E12X(0) E150(0) E200(0)



Reading history

Five kinds of reading data are displayed.

CHECK!

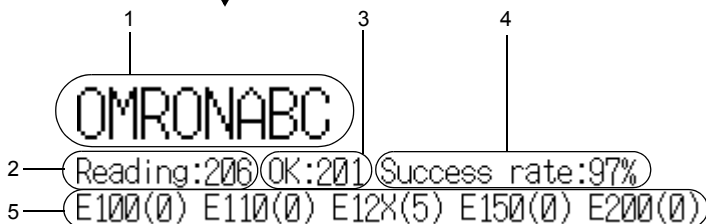
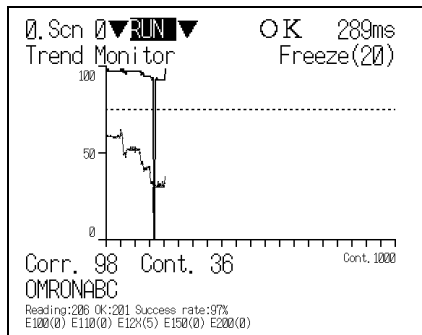

Item	Description
1. Reading data	The most recent reading data is displayed.
2. Total reads	The number of reading executions is displayed.
3. OK reads	The number of OK reads within the number of executed reads is displayed.
4. Read accuracy	The percentage of OK reads within the number of executed reads is displayed.
5. Number of error codes	The types and number of occurrences of error codes associated with NG reads are displayed.

■ Referring to NG Reading Results (Warning Transition)

The measured values and time of occurrence for up to 1000 events within the trend monitor reading results where an alarm or reading NG result has occurred can be referred to.

This function enables you to determine the time frames in which NG reading results have occurred, and helps analyze the causes of NG results.

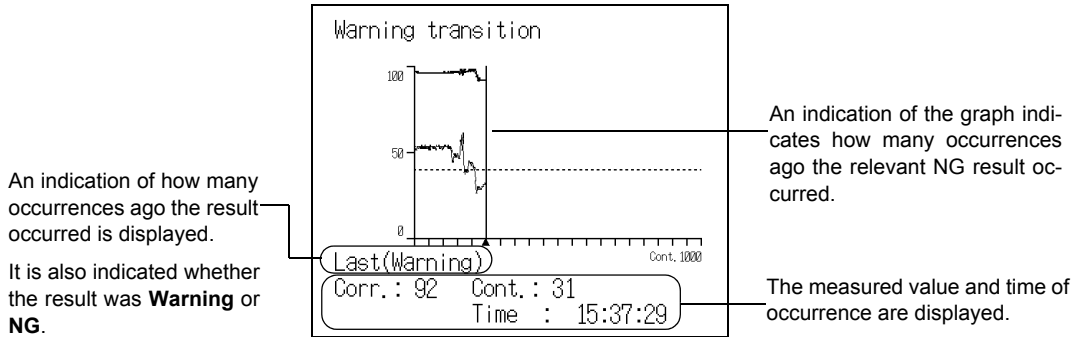

1. Select **TrendMon settings/Warning transition**.

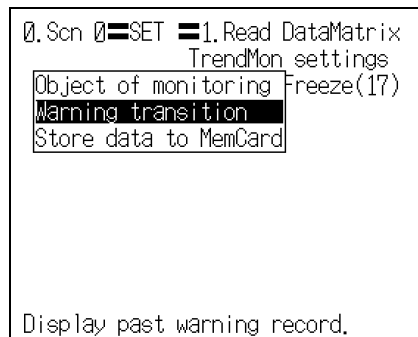

A graph is displayed.

2. Change the displayed NG result using **Left/Right** Keys.

Left Key : To display the previous result

Right Key : To display the next result

3. Press the **ESC** Key.

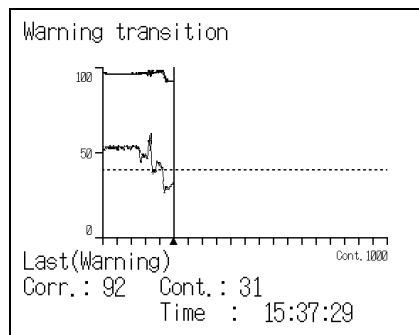

The screen in **1.** will return.

■ Saving Reading Data (Store Data to MemCard)

The reading results recorded in the trend monitor can be saved in a Memory Card. Since the data is saved in CSV format, it can be edited on a PC.

Data to be saved include statistical data, the read data and times of occurrence when alarms and NG results occurred (up to 1000 events), and the reading results on the graph (up to 1000 results).



When **Store data to MemCard** is turned ON, a directory designated **TRENDMON** is automatically created in the root directory of the Memory Card, and the data is saved under this directory.

CHECK!

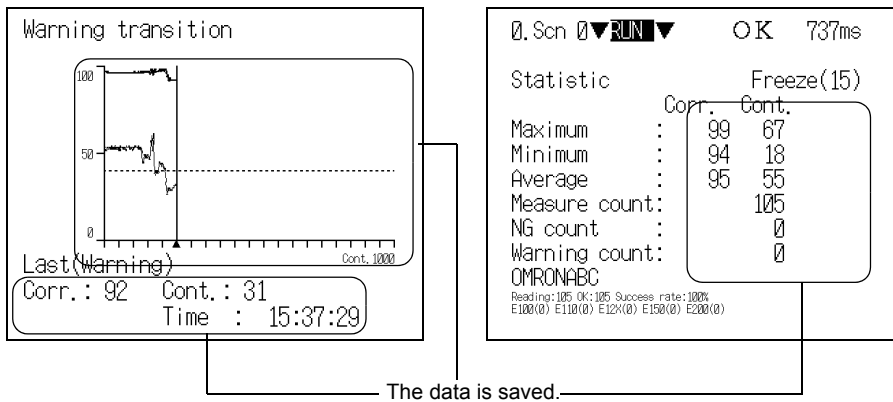

■ CSV Format

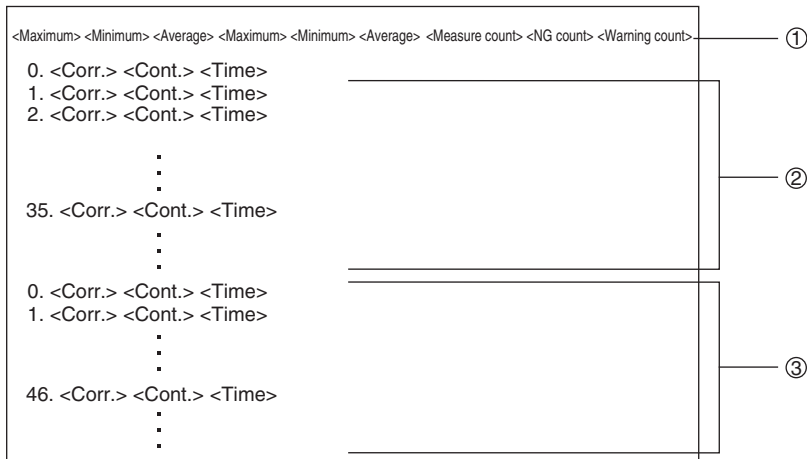

- ①: **Statistic data**
The maximum value, minimum value, and average value are saved for correlation first and then contrast.
- ②: **Reading results when alarms and NG results occurred**
Up to 1000 NG results starting from the most recent are saved.
- ③: **Reading results on the graph**
Up to 1000 results starting from the most recent data are saved.

- 1.** Insert the Memory Card.
- 2.** Select **TrendMon settings/Store data to MemCard.**

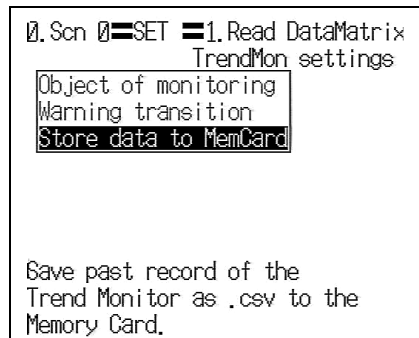

▼
The setting screen will be displayed.

- 3.** Move the cursor to [] of the file name and press the **ENT** Key.



Before the file name is set, the date on which the data is saved is input.

CHECK!

If you do not wish to change the file name, proceed to the screen in **6.**

To change the file name, follow the procedure **4.** to **5.**

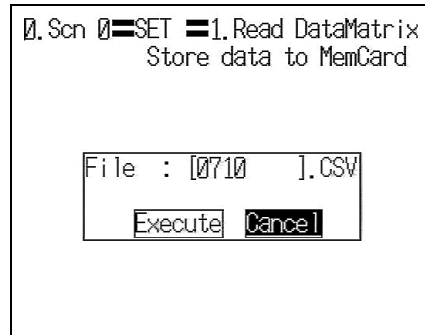

▼
The software keyboard will be displayed.

- 4.** Set the file name with up to 8 characters.



Periods (.) cannot be used in file name.

CHECK!

- 5.** Move the cursor to **END** and press the **ENT** Key.

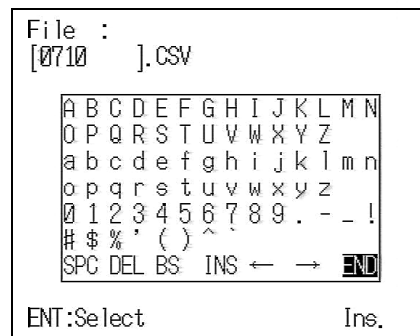

The screen in **3.** will return.

6. Select **Execute**.

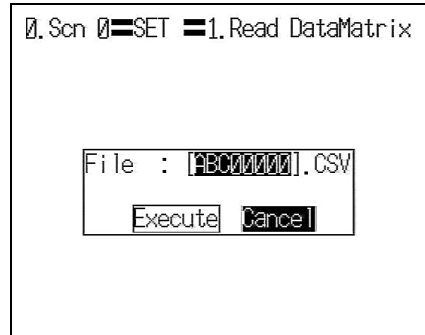

▼
The data is saved under the **TRENDMON** directory, and the screen in **1.** will return.

Setting Reading Conditions (QRCode)

Set the reading conditions in accordance with the reading object.
The explanation here deals with the settings for QRCode.

Pattern Settings



A finder pattern image is registered in advance, then when reading is executed a search is conducted for an image pattern similar to the input image in order to locate the code.

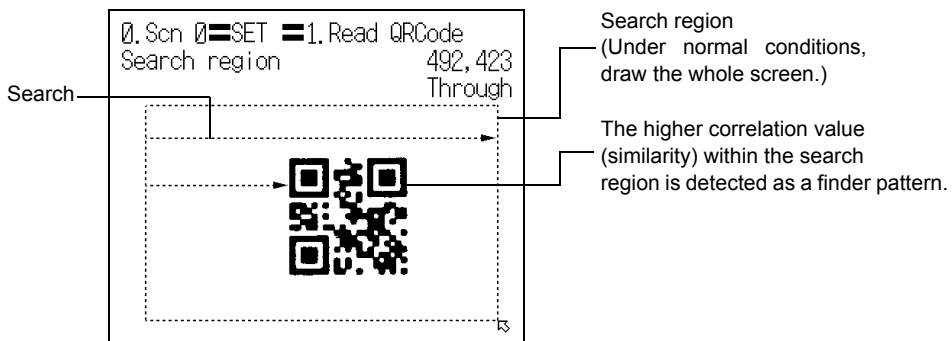
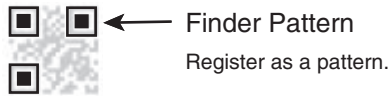

 What is a pattern search?  Refer to page 285 (Sec.10).



■ **Pattern Registration**

The finder pattern image is registered as a pattern. Use the teaching function for registration. Using the teaching function, a reading image is obtained, measurement is performed on this image, and based on the results of this measurement, parameters for reading conditions (symbol color, Right & Left reverse) are automatically determined. The teaching results can be checked or changed in **Code settings**.

 What is Black & White Reverse?  Refer to page 284 (Sec.10).

 What is Right & Left Reverse?  Refer to page 284 (Sec.10).

 When registering patterns, be sure to carry out reading by trigger input and complete teaching for each pattern registration. You cannot register patterns consecutively without performing teaching processing.
CHECK!

Up to 10 patterns can be registered for one scene, and **Code settings** and **Search region** are set for each of these patterns. Registering multiple patterns enables reliable reading even if there is dispersion in the dot spacing and printing quality. In addition, if codes with different versions and symbol colors are registered as patterns, multiple codes can be read in one scene. This makes scene changes unnecessary.

Up to 10 patterns can be registered.

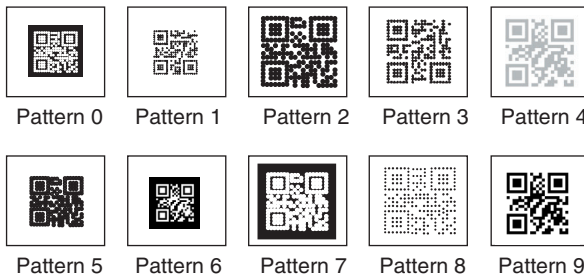

Multiple pattern registrations for a single code with dispersion, or pattern registration of codes with different versions or symbol colors

 DataMatrix and QRCode cannot be mixed in pattern registrations.
CHECK!

1. Select **1.Read QRCode**.



To change the code to be read, press the **SHIFT + ESC** Keys.

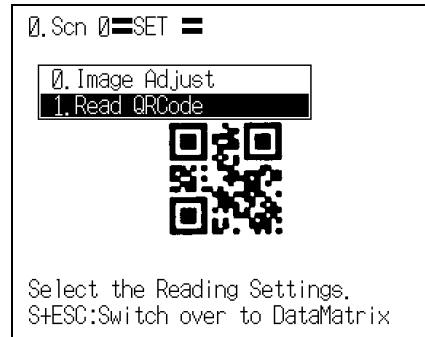

▼
The initial screen for the QRCode reading will be displayed.

2. Select **Pattern settings**.

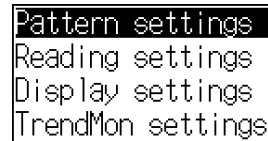

▼
The Pattern list will be displayed.

3. Select the pattern number to be registered.

Up/Down/Left/Right Keys: To move among pattern numbers.

The selected pattern number is indicated with a solid-line frame.

4. Press the **ENT** Key to validate the setting.

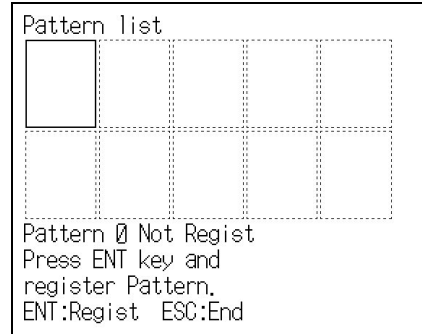

▼
The Pattern settings selections will be displayed.

5. Select **Pattern registration**.



The Pattern registration screen will be displayed.

- 6.** Select the image to be registered by pressing the **SHIFT + Up/Down** Keys.
- 7.** Press the **ENT** Key to validate the setting.

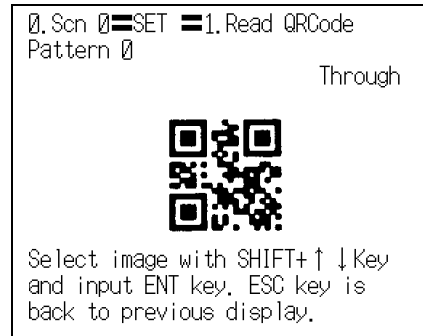

The Version selections will be displayed.

- 8.** Select the desired version.



What is a version?  Refer to page 284 (Sec.10).

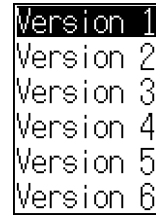

The finder pattern range setting screen is displayed.

- 9.** Designate the point at the top left of the finder pattern.

Designate about 0.5 cells outside the edge of the finder pattern.

A margin of at least 1 cell (combined margin for both sides) is required around the code.

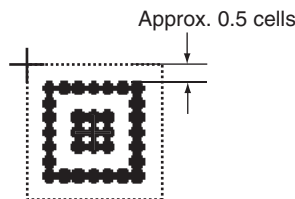
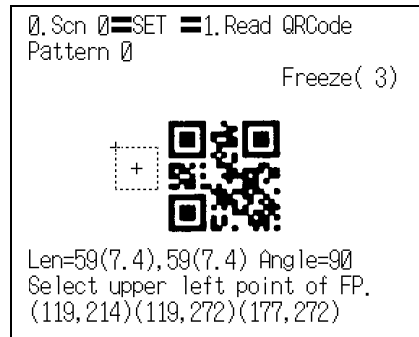

Up/Down/Left/Right Keys : To move the cursor.

SHIFT + Up/Down/Left/Right Keys : To move the cursor at 10 times normal speed.

ENT Key : To confirm.



CHECK!

At the bottom left of the screen are displayed the length of the L shape, the number of pixels per cell (the numerical value in parentheses), the angle, and the coordinates of the three points. Adjust the field of vision so that there are at least 5 pixels per cell.



Refer to pages 46 to 48 (Sec.2).



What is a pixel?  Refer to page 283 (Sec.10).



What is a cell?  Refer to page 284 (Sec.10).

10. Designate the bottom left and bottom right points in the same way.

The selections for the range of angle are displayed.



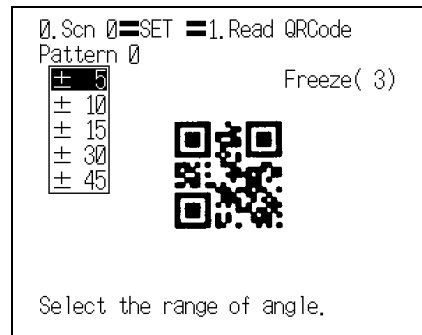









11. Select the code inclination range and press the ENT Key.



CHECK!

Code inclinations are specified in relation to 0°, 90°, 180°, or 270°.

Example: When the inclination is ± 15

Direction of the code	-15°	15°
0° 		
90° 		
180° 		
270° 		

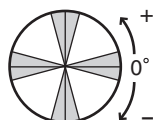

The gray part is the part for which the inclination designation is effective.

The Pattern registration confirmation screen will be displayed.

12. Press the **ENT** Key.



The setting will be registered and the screen in **5.** will return.

13. Press the **ESC** Key four times.



The Monitor mode screen will return.

14. Press the **TRIG** Key to perform teaching.



If the result of teaching is OK, the Symbol color, Right & Left reverse, and Version information are displayed, and the pattern is registered.

Repeat these steps to register multiple patterns.



CHECK!

If the result of teaching is NG, go to the screen in **3.** (pattern list screen), delete the pattern, adjust the camera focus, lighting, and so on, then carry out pattern registration again.







CHECK!

If reading is performed successfully, the teaching function will automatically turn OFF. If reading is not performed correctly (NG), the teaching function will stay ON. To turn the teaching function OFF, go to the screen in **3.** (pattern list screen). To redo pattern registration, enter **SET** mode and start the procedure again from **5.**

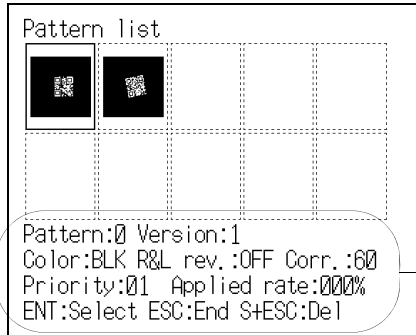
The following setting information for pattern registration is displayed on the **Pattern list** screen.



Pattern setting information

Item	Description
Pattern	Selected pattern number
Version	Matrix size (Version)
Color	Symbol color of the pattern
R&L rev.	Execution/non-execution of pattern Right & Left reverse
Corr. (Correlation)	Pattern correlation value
Priority	Pattern sequence used when reading  Refer to page 113.
Applied rate	Applied rate of the pattern Applied rate = $\frac{\text{Number of times a pattern is used}}{\text{Total reads}^*}$ * The maximum number of reads is the most recent 10000.



CHECK!

To register a pattern again or register a new pattern, select the pattern number and press **ENT** Key, and repeat the procedure from step **5.**



Refer to page 131.

- To delete a pattern

1. Select the pattern number of the pattern that you want to delete from the **Pattern list** screen.

Up/Down/Left/Right Keys: To move among pattern numbers.

The selected pattern number is indicated with a solid-line frame.

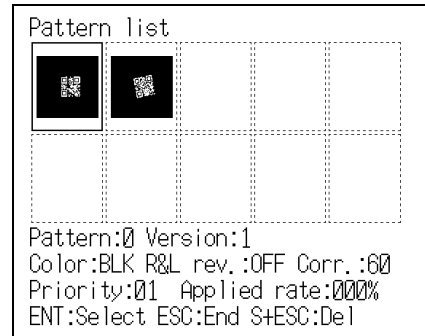

2. Press the **SHIFT + ESC** Keys.

▼
The confirmation message will be displayed.

3. Select **Execute**.



▼
The pattern is deleted, and the screen in **1.** will return.

Code Settings

Set the conditions to apply in pattern searches.

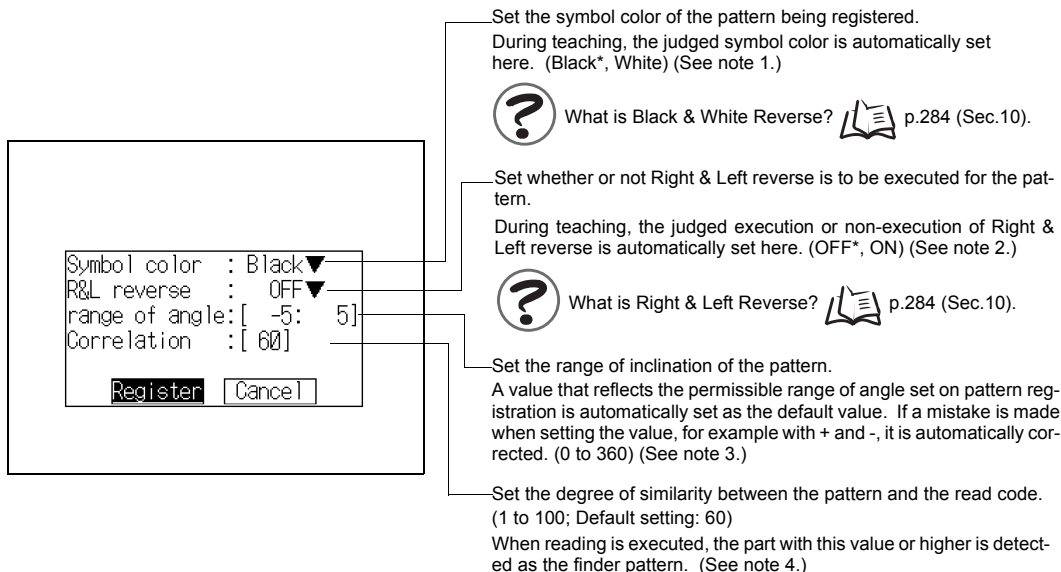

The dialog box contains the following settings:

- Symbol color : Black
- R&L reverse : OFF
- range of angle : [-5: 5]
- Correlation : [60]

Callouts provide detailed explanations for each setting:

- Symbol color:** Set the symbol color of the pattern being registered. During teaching, the judged symbol color is automatically set here. (Black*, White) (See note 1.)
- R&L reverse:** Set whether or not Right & Left reverse is to be executed for the pattern. During teaching, the judged execution or non-execution of Right & Left reverse is automatically set here. (OFF*, ON) (See note 2.)
- range of angle:** Set the range of inclination of the pattern. A value that reflects the permissible range of angle set on pattern registration is automatically set as the default value. If a mistake is made when setting the value, for example with + and -, it is automatically corrected. (0 to 360) (See note 3.)
- Correlation:** Set the degree of similarity between the pattern and the read code. (1 to 100; Default setting: 60) When reading is executed, the part with this value or higher is detected as the finder pattern. (See note 4.)

The asterisk (*) indicates the default setting.

Note 1: Symbol color



Black:
When black is printed on a white background



White:
When white is printed on a black background

Note 2: R&L reverse



OFF:
When reading is done from the front

Front face (reading face)



Rear face (reading face)



Front face

ON:
When a transparent object such as one of glass is read, or a rear view of an object reflected in a mirror

Note 3: Range of angle

Example: When the permissible range of angle is $\pm 30^\circ$

Reading is possible within the ranges of angle of $0^\circ \pm 30$, $90^\circ \pm 30$, $180^\circ \pm 30$, $270^\circ \pm 30$.

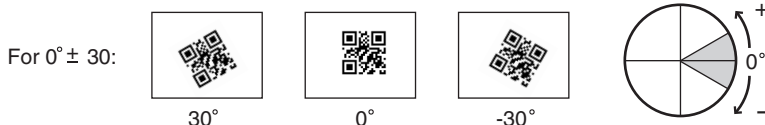

Note 4: Correlation

Example: When the correlation value is **60**

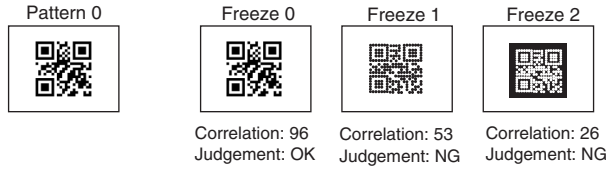

1. Select the pattern number that you want to set on the **Pattern list** screen.

Up/Down/Left/Right Keys: To move among pattern numbers.

The selected pattern number is indicated with a solid-line frame.

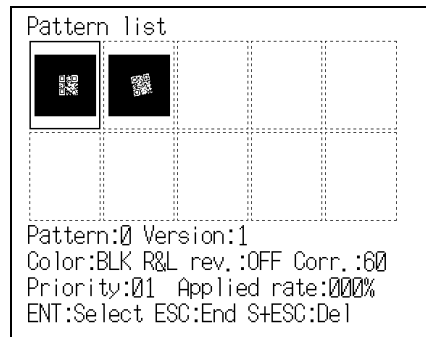

2. Press the **ENT** Key.

▼
The Pattern settings selections will be displayed.

3. Select **Code settings**.

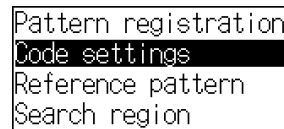

▼
The setting items will be displayed.

4. Make the settings for each item.

5. Select **Register**.

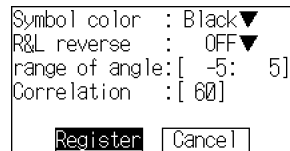

▼
The setting will be registered and the screen in **3.** will return.

■ Reference Pattern

The registered pattern is displayed on the monitor screen and can be checked. After performing pattern registration, always compare the pattern with a reference and check if the finder pattern has been registered correctly.

1. Select the pattern number of the pattern that you want to refer to on the **Pattern list** screen.

Up/Down/Left/Right Keys: To move among pattern numbers.

The selected pattern number is indicated with a solid-line frame.

2. Press the **ENT** Key.

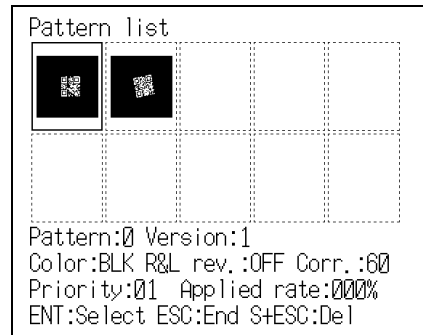

The Pattern settings selections will be displayed.

3. Select **Reference pattern**.

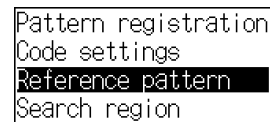

The Reference pattern screen will be displayed. Detailed information about the pattern will be displayed at the bottom of the screen.



For information on detailed information about patterns, refer to page 135.

4. Press the **ESC** Key to leave this screen.

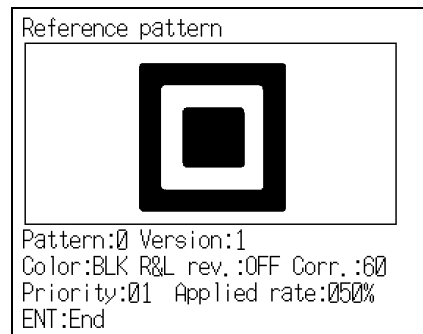

The screen in **3.** will return.

■ Search Region

Specify the range within which the pattern search is to be conducted.

1. Select the pattern number of the pattern that you want to set on the **Pattern list** screen.

Up/Down/Left/Right Keys: To move among pattern numbers.

The selected pattern number is indicated with a solid-line frame.

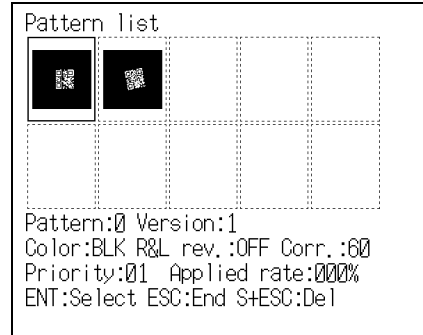

2. Press the **ENT** Key.

The Pattern settings selections will be displayed.

3. Select **Search region**.



The Search region setting screen will be displayed.

4. The search region is depicted as a rectangle.

Up/Down/Left/Right Keys : To move the cursor.
ENT Key : To confirm.

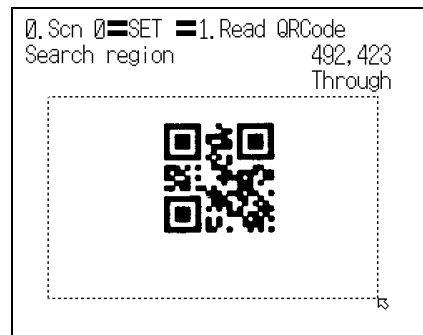

When you set the bottom right coordinates the search region is confirmed and the screen in **3.** will return.

Reading Settings

Set the conditions for reading QRCode.

Set whether the controller automatically selects a pattern when reading is executed, the timeout time for reading, and the number of retries executed in the event of an NG reading result.

The details of the setting method are the same as those described for **Read DataMatrix**.



Refer to page 112.

Display Settings

Set the contents displayed in **MON** (monitor) mode and **RUN** mode.

Select whether or not the guidance displayed at the bottom of the monitor screen is displayed, and whether or not reading data is displayed.

If you increase the number of monitor display items, processing time increases proportionately.

The details of the setting method are the same as those described for **Read DataMatrix**.



Refer to page 114.

Trend Monitor Settings

Up to 1000 events showing the transition over time of the “pattern correlation value” or “contrast between the code and background” can be displayed in graph form. Changes in the shape of the code and the trend in changes in the lighting status can be checked by monitoring. This helps prevent multiple occurrences of defective items, and the analyze the cause when NG results occur.

The details of the setting method are the same as those described for **Read DataMatrix**.







Refer to page 119.

MEMO

SECTION 6

Other Functions

This section describes additional functions such as changing scenes or backing up data.

 Changing Scenes (Scene Function)	144
 Backing Up Data	149
 Memory Card Operations	163
 Checking I/O Status with Host Devices (I/O Monitor)	173

Changing Scenes (Scene Function)

When two cameras are used, when the shutter speed differs according to the read code, or when the type of the read code (DataMatrix/QRCode) differs, use the scene function.

The different situations in which readings are performed are called “scenes” and the reading conditions set in **SET** Mode are called “scene data.” The scene function can be used to set 10 types of reading conditions. If reading conditions change, simply switch to change to a different reading scene.

The normal limit of 10 scenes may not be possible for some settings if there is insufficient memory. A message will appear on the screen if there is insufficient memory. Delete unnecessary patterns.

Setting Reading Conditions for Different Codes (Changing Scenes)

Use the scene changing function to switch between different reading conditions for different reading conditions or reading object. The V530-R160 is factory set to start up in scene 0. In addition to this, however, there are other scenes, scenes 1 to 9.

The command for changing scenes can be input from a host device via a parallel I/O or serial interface.

1. The **MON** (monitor) mode or **RUN** mode screen will be displayed.
2. Move the cursor to **Scn** and press the **ENT** Key.

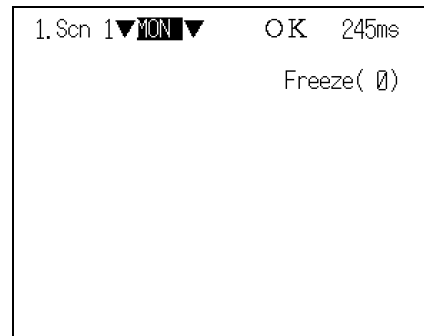

The **Scn 0** to **Scn 7** options will be displayed.

Down Key: To display scene numbers 8 to 10.

- 3.** Move the cursor to the scene number to be switched to and press the **ENT** Key.

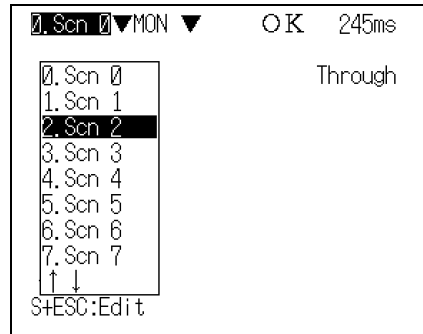

The selected scene will be displayed.



Copying Reading Conditions

This function is useful for creating new scenes by copying scene data from another scene and changing some settings to suit the new requirements.

1. Move the cursor to **Scn** and press the **ENT** Key.
2. Move the cursor to the desired scene number.
3. Press the **SHIFT + ESC** Keys.

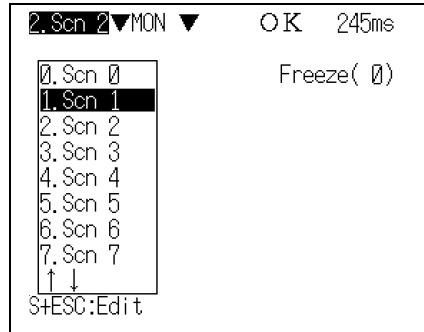

The Copy/Clear/Comment selections will be displayed.

4. Select **Copy**.



The screen for copying will be displayed

5. Set the original scene number and select **Execute**.

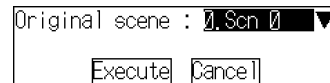

The scene will be copied.

Initializing Reading Conditions (Clearing Scenes)

Use the following procedure to clear reading conditions set in scenes. This section explains the procedure performed separately for each scene.

1. Move the cursor to **Scn** and press the **ENT** Key.
2. Move the cursor to the number of the scene to be cleared.
3. Press the **SHIFT + ESC** Keys.

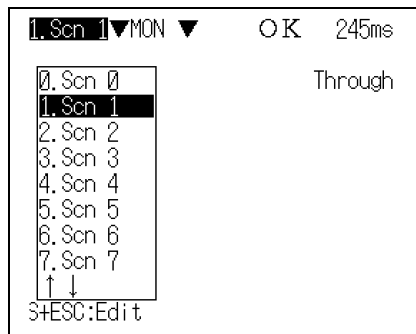

The Copy/Clear/Comment selections will be displayed.

4. Select **Clear**.



The confirmation message will be displayed.

5. Select **Execute**.

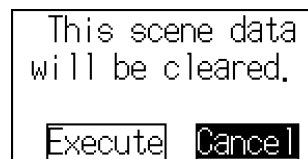

The scene will be cleared.

Adding Comments to Scenes

Any comment can be added to each scene. This is useful for understanding settings when many regions have been registered.

1. Move the cursor to **Scn** and press the **ENT** Key.
2. Move the cursor to the number of the scene for the name change.
3. Press the **SHIFT + ESC** Keys.

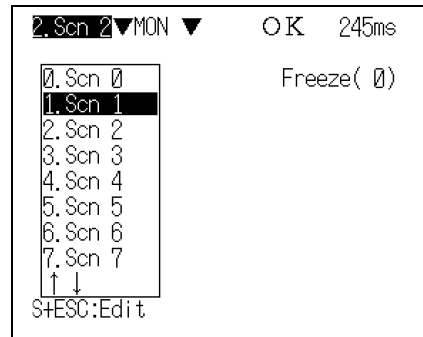

The Copy/Clear/Comment selections will be displayed.

4. Select **Comment**.



The software keyboard will be displayed.

5. Set a comment with up to 8 characters.
6. Move the cursor to **END** and press the **ENT** Key.

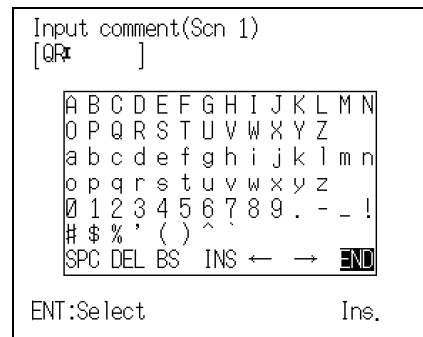

The scene name will be changed.

Backing Up Data

This section explains how to make backup copies of data to flash memory or a computer.

When the power to the V530-R160 is turned OFF, all data settings are cleared. The V530-R160 loads data saved to flash memory at startup. Therefore, when settings have been changed, be sure to save to flash memory before turning the power OFF.

The 4 types of system and scene data listed below can be backed up on a computer or Memory Card. This is a useful function for setting other devices with the same data. Backing up the setting data is recommended as a precaution against loss due to data damage or device malfunctions.

Data	Contents
System data	Backs up settings under SYS to a personal computer or Memory Card.
Scene data	Backs up settings under SET for each scene to a personal computer or Memory Card.
System data + Scene data	Backs up both the system data and all scene data to a personal computer or Memory Card.
Image data	<p>Backs up saved read images in BMP format to a personal computer or Memory Card. The images can be displayed on most personal computers as BMP is a standard image format for Windows.</p> <p>The saved images can be batch saved to the root directory in the Memory Card. The file names they are saved under are automatically appended with the figures 00 to 35 corresponding to the memory numbers of the controller. (00.bmp to 35.bmp)</p> <p>The image data in the root directory of the Memory Card (00.bmp to 35.bmp) can also be batch loaded to the controller. Set file names for the data to be loaded from 00.bmp to 35.bmp corresponding to the memory numbers.</p>

NOTICE

Never input the RESET signal or turn OFF the power while saving or loading. Data may be lost, and the V530-R160 may not operate properly the next time it is started.

Backing Up to Flash Memory

The scene data and system data will be saved to the V530-R160 internal flash memory.



Flash memory data or Memory Card data is loaded each time the V530-R160 is started up. Therefore, when settings have been changed, be sure to save to flash memory before turning the power OFF. Any new data will be lost if it is not saved to flash memory.

CHECK!

1. The **MON** (monitor) mode or **RUN** mode screen will be displayed.
2. Move the cursor to **MON** or **RUN** and press the **ENT** Key.

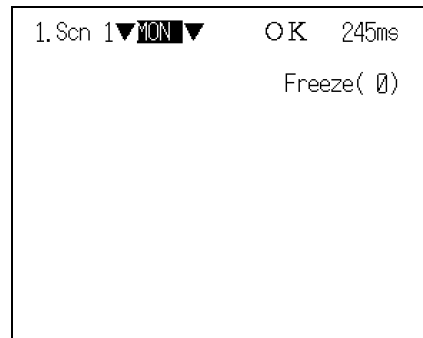

▼
The mode selections will be displayed.

3. Select **SAVE**.

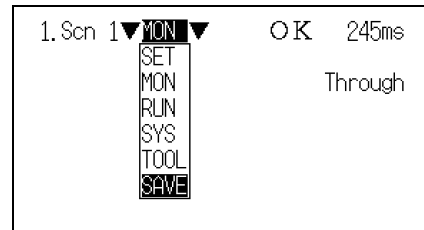

▼
The confirmation message will be displayed.

4. Select **Execute**.

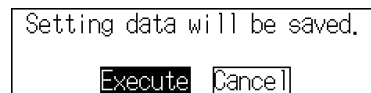

Never input the RESET signal or turn OFF the power when processing messages are displayed. Data may be lost, and the V530-R160 may not operate properly the next time it is started.

CHECK!

▼
When saving has been completed, the screen in **1.** will return.

Backing Up Data to a Computer

This section describes data transfer using the Hyper Terminal provided on Windows 98, Windows 2000 and Windows NT4.0 computers.

In this example, an RS-232C cable is connected to the COM1 port of the computer.

Alter the example to suit your communications software or COM port number. If using different communications software, refer to the relevant manual.

The data transfer is performed with XMODEM (-CRC or SUM) or ZMODEM protocol. The XMODEM (-1K) protocol is not supported.

■ Saving Data

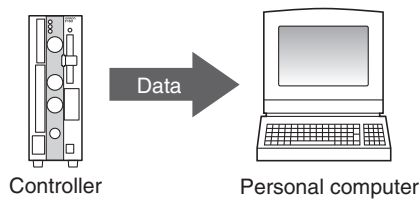

1. Connect the COM1 port on the computer and the V530-R160 using an RS-232C cable.
2. Make the V530-R160 communications settings (serial).

The default communication settings are as shown in the following table. These settings can be normally used.

Item	Setting
Communications protocol	RS-232C
Baud rate	38400 (bps)
Data length	8 (bit)
Parity bits	None
Stop bits	1 (bit)
Protocol	XMODEM*

 p.206 (Sec. 8).

* Both XMODEM and ZMODEM transfer protocols are supported. Use the protocol that matches the computer settings.

3. Start the Hyper Terminal program on the computer and make the following communication settings.

The same communication settings must be used on both the V530-R160 and the modem on the computer.

Item	Setting
Baud rate	38400 (bps)
Data bits	8 (bit)
Parity bits	None
Stop bits	1 (bit)
Flow control	None*

* XMODEM or ZMODEM protocol is used, so flow control is not performed.

4. Once the computer preparations have been completed, display the **MON** (monitor) mode or **RUN** mode screen.

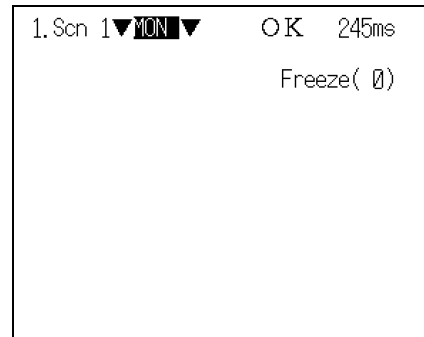

5. Move the cursor to **MON** or **RUN** and press the **ENT** Key.

▼
The mode selections will be displayed.

6. Select **TOOL**.

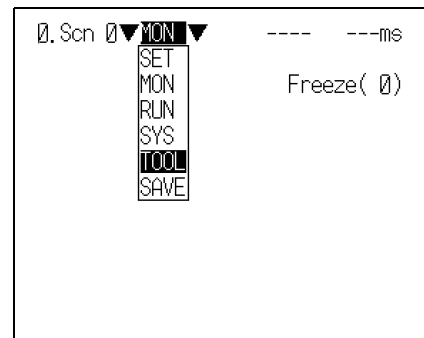

▼
The data selections will be displayed.

7. Select the kind of data to be saved.

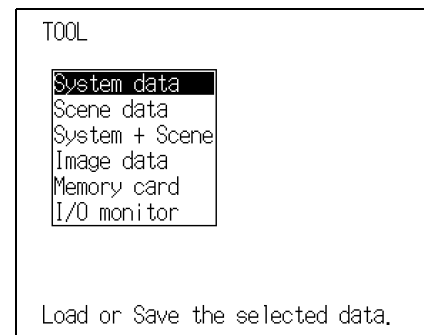

▼
The destination selections for load and save will be displayed.

8. Select **Save (Serial)**.

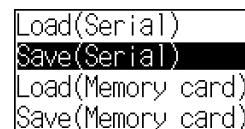

- 9.** If scene data or image data is being transferred, select the desired scene number or memory number.

When using ZMODEM for communications, set a file name of 8 characters or less after inputting the desired number.

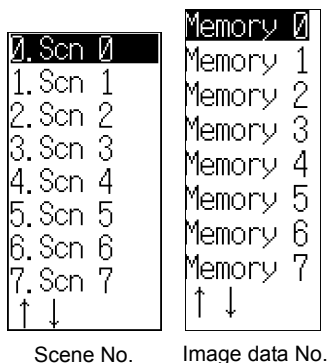

The confirmation message will be displayed.

Example: Confirmation message when saving system data.

- 10.** Select **Execute**.

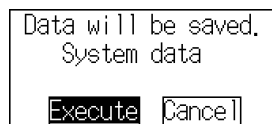

A screen showing the transfer progress will be displayed.

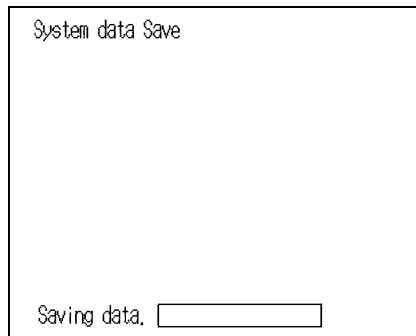

- 11.** Select **Transfer/Receive File** from the computer's Hyper Terminal menu.
- 12.** Specify a destination directory where the file will be saved.
- 13.** Use **XMODEM** or **ZMODEM** protocol.
- 14.** Select **Receive**. When using **XMODEM**, input a file name. The data will be transferred from the computer to the V530-R160.

When transfer has been completed, the screen in **8.** will return.

■ Loading Data

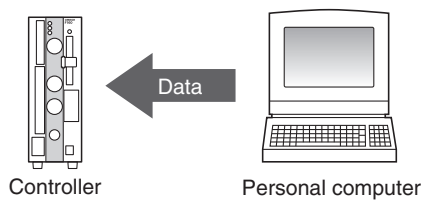

-
1. Follow the procedure **1.** to **3.** for *Saving Data* to connect the V530-R160 and the computer.
 Refer to page 152.
 2. Select **Transfer/Receive File** from the computer's Hyper Terminal menu.
 3. Select the file to be loaded.
 4. Use **XMODEM** or **ZMODEM** protocol.
 5. Select **Send**.
-
- ▼

The data transfer screen will be displayed.

6. Once the computer preparations have been completed, display the **MON** (monitor) mode or **RUN** mode screen.
7. Move the cursor to **MON** or **RUN** and press the **ENT** Key.

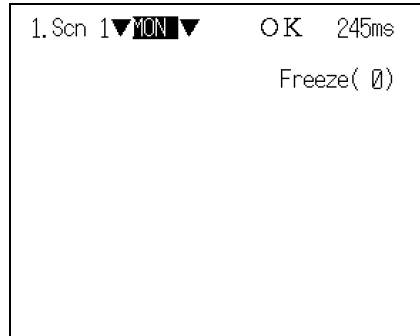

The mode selections will be displayed.

8. Select **TOOL**.

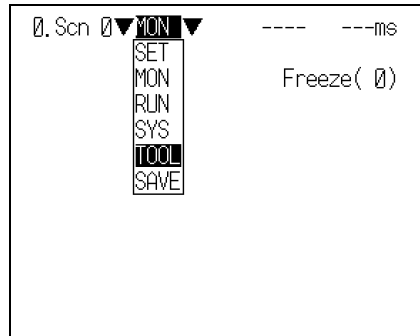

The data selections will be displayed.

9. Select the kind of data to be loaded.

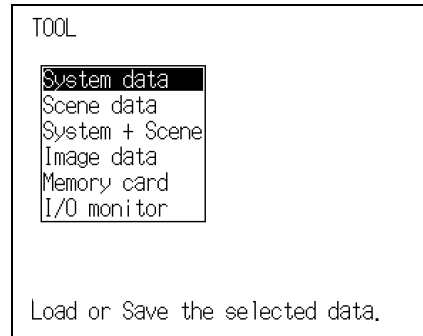

The destination selections for load and save will be displayed.

10. Select **Load (Serial)**.

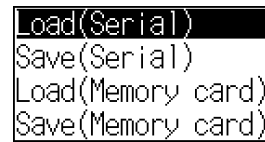

11. If scene data or image data is being transferred, select the desired scene number or memory number.

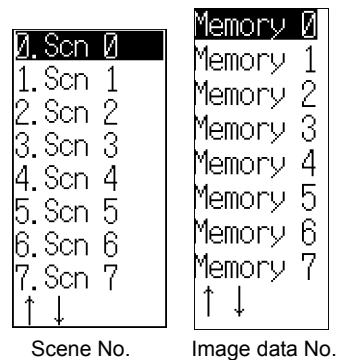

The confirmation message will be displayed.

12. Select **Execute**.
- The data will be transferred from the computer to the V530-R160.

Example: Confirmation message when loading system data.

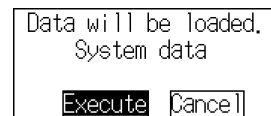

When loading has been completed, the screen in 10. will return.

Backing Up Data to a Memory Card

This section describes inserting a Memory Card and backing up settings data to the Memory Card.



Turn OFF the power supply to the Memory Card before removing the Memory Card.



Refer to page 172.

■ Saving Data to a Memory Card (V530-R160 to Memory Card)

1. Insert the Memory Card.
2. The **MON** (monitor) mode or **RUN** mode screen will be displayed.
3. Move the cursor to **MON** or **RUN** and press the **ENT** Key.

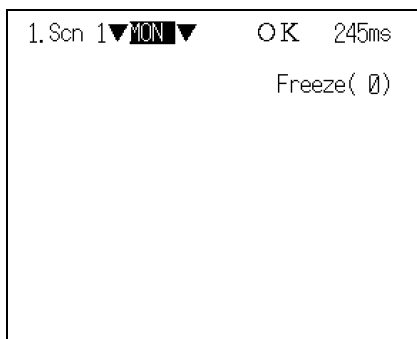

The mode selections will be displayed.

4. Select **TOOL**.

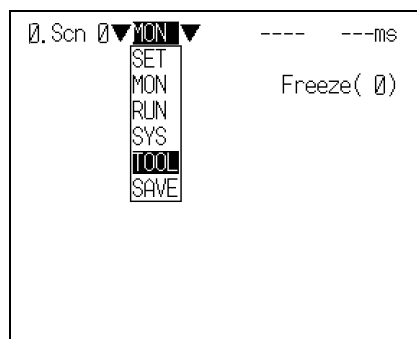

The data selections will be displayed.

5. Select the kind of data to be saved.

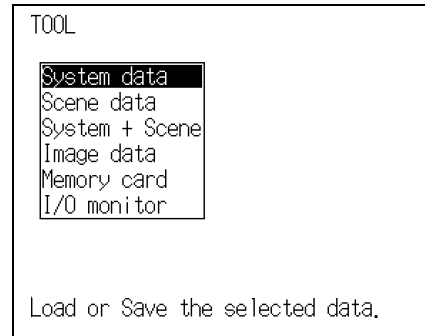

The destination selections for load and save will be displayed.

6. Select **Save (Memory card)**.

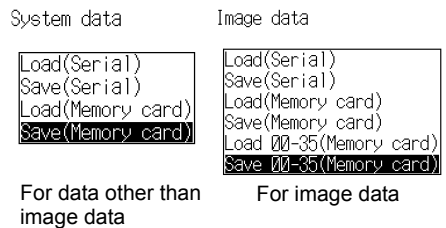

7. If scene data or image data is being transferred, select the desired scene number or memory number.

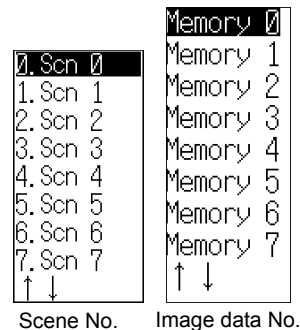

A list of files in the Memory Card root directory will be displayed.



/C0 indicates the drive name of the Memory

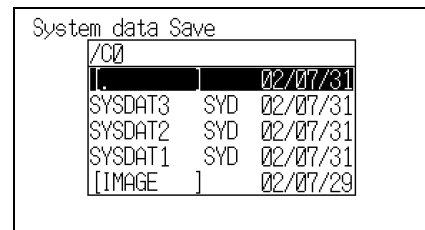

To overwrite existing files, select the file by pressing the **ENT** Key and then go to **12..**
To specify a new file name, perform the procedure **8.** to **11..**

8. Press the **SHIFT + ESC** Keys.

The edit menu will be displayed.

9. Select **New file**.



CHECK!

If **Make directory** is selected, the screen for creating new directories will be displayed. Files can be saved in the newly created directory.

```
Property
Make directory
New file
Change name
Delete
```

The software keyboard will be displayed.

10. Set the file name with up to 8 characters.



CHECK!

Periods (.) cannot be used in file name.

```
New file(System data )
[SYSDAT* ].SYD

 B C D E F G H I J K L M N
O P Q R S T U V W X Y Z
a b c d e f g h i j k l m n
o p q r s t u v w x y z
0 1 2 3 4 5 6 7 8 9 . - _ !
# $ % ' ( ) ^ `
SPC DEL BS INS ← → END

ENT:Select                               Ins.
```

11. Move the cursor to **END** and press the **ENT** Key.

The confirmation message will be displayed.

Example: Confirmation message when saving system data.

12. Select **Execute**.

```
Data will be saved.
System data
↓
SYSDAT4.SYD

Execute Cancel
```

When saving has been completed, the screen in **6.** will return.



CHECK!

If **Image data/Save 00-35 (Memory card)** is set, the image data accumulated in the controller (Memory 0 to Memory 35) can be batch saved in the root directory of the Memory Card. The suffixes 00.bmp to 35.bmp are automatically appended to the file names.

■ Loading Data from the Memory Card (Memory Card to V530-R160)

1. Follow the procedure 1. to 5. for *Saving Data to a Memory Card* and move to the screen for selecting load destinations.

 Refer to page 158.

2. Select **Load (Memory card)**.

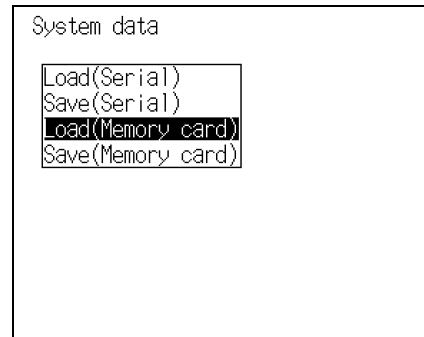

3. If scene data or image data is being transferred, select the desired scene number or memory number.



The screen for selecting files will be displayed.

4. Select the file to be loaded.



/C0 indicates the drive name of the Memory Card.

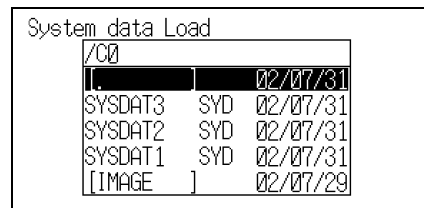

The confirmation message will be displayed.

5. Select **Execute**.

Example: Screen for loading system data

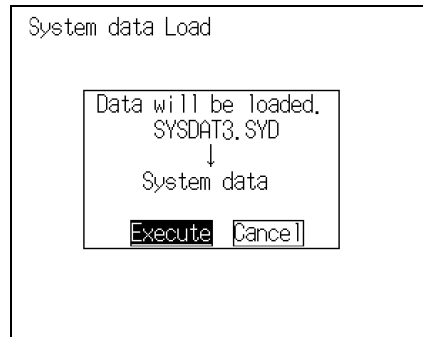

When loading has been completed, the screen in **1.** will return.



If **Image data/Load 00-35 (Memory card)** is set, the image data in the root directory of the Memory Card (00.bmp to 35.bmp) can be batch loaded to the controller.

Memory Card Operations

The method for managing the files saved in the Memory Card, and the method for stopping the power supply to the Memory Card, are explained here.

NOTICE Turn OFF the power supply to the Memory Card before removing the Memory Card. If the power is not turned OFF before the Memory Card is removed, the Memory Card and the V530-R160 may be damaged.

 Refer to page 172.



CHECK! The **IC0** displayed on the screen while operations are in progress inside the Memory Card indicates the drive name of the Memory Card.

Creating Directories

Directories can be created in the Memory Card and files can be stored in those directories. It is easier to find files if separate directories are created for related files.

1. Insert the Memory Card.
2. The **MON** (monitor) mode or **RUN** mode screen will be displayed.
3. Move the cursor to **MON** or **RUN** and press the **ENT** Key.

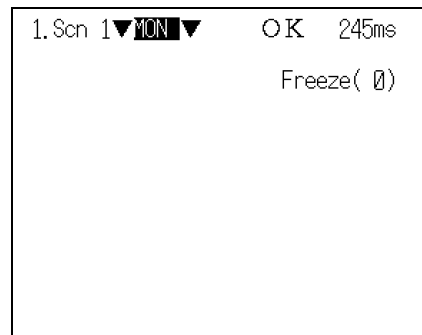

The mode selections will be displayed.

4. Select **TOOL**.

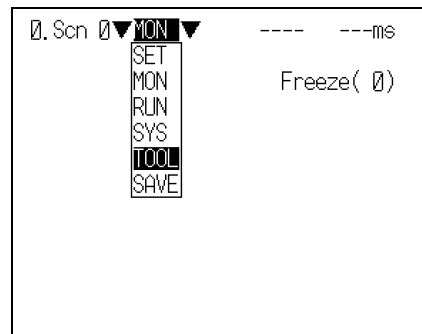

The TOOL mode selections will be displayed.

- 5.** Select **Memory card**.

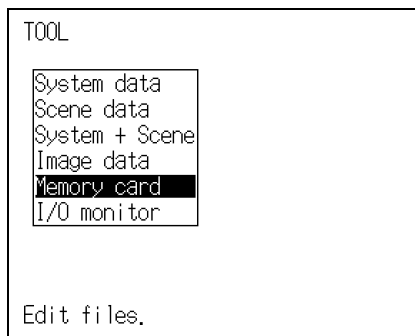

The Copy file/File operation/Drive status menu will be displayed.

- 6.** Select **File operation**.



A list of files in the Memory Card root directory will be displayed.

- 7.** Press the **SHIFT + ESC** Keys.

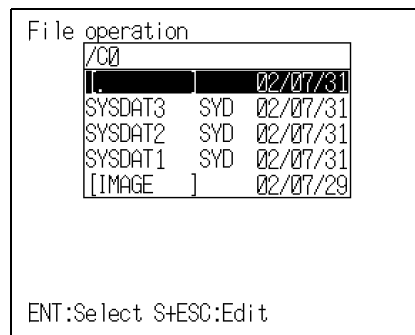

The edit menu will be displayed.

- 8.** Select **Make directory**.



The software keyboard will be displayed.

- Input the directory name, using up to 8 characters.



Periods (.) cannot be used in file names.



- Move the cursor to **END** and press the **ENT** Key.

The confirmation message will be displayed.

- Select **Execute**.



The directory will be created and the screen in **7.** will return.



The directory is displayed in the list of files, enclosed in square brackets [].

Move the cursor to the directory and press the **ENT** Key to display a list of files in that directory.

Example:

When directory **DIC_1** is selected.

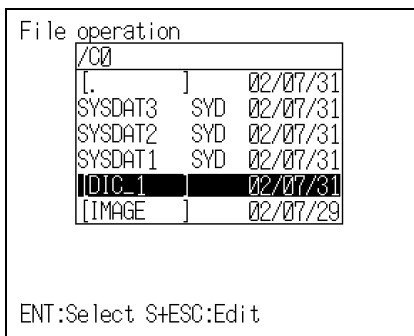

The files in **DIC_1** will be displayed.

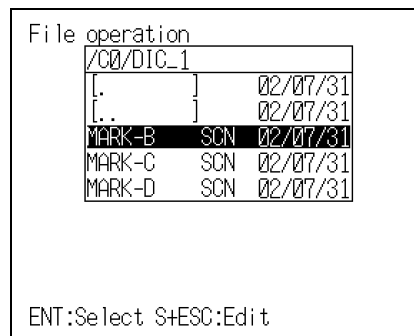

Select [..] to move up a level.

Copying Files

- Follow the procedure **1.** to **5.** for *Creating Directories* and display the **Copy file/File operation/Drive status** menu.

 Refer to page 163.

- Select **Copy file**.

```
Copy file
File operation
Drive status
```

▼
A list of files in the Memory Card root directory will be displayed.

- Move the cursor to the file to be copied and press the **ENT** Key.

```
Original
/CD
[.]          02/07/31
SYSDAT3  SYD  02/07/31
SYSDAT2  SYD  02/07/31
SYSDAT1  SYD  02/07/31
[DIC_1 ]  02/07/31
[IMAGE ]  02/07/29

ENT:Select S+ESC>Edit
```

▼
A screen for specifying the copy destination will be displayed.

```
Copy (Original: SYSDAT3.SYD)
/CD
[.]          02/07/31
SYSDAT3  SYD  02/07/31
SYSDAT2  SYD  02/07/31
SYSDAT1  SYD  02/07/31
```



To overwrite existing files, select the file by pressing the **ENT** Key and then go to **8.**
To specify a new file name, follow the procedure **4.** to **7.**

- Press the **SHIFT + ESC** Keys.

The selections will be displayed.

5. Select **New file**.



CHECK!

If **Make directory** is selected, the screen for creating new directories will be displayed. Files can be saved in the newly created directory.

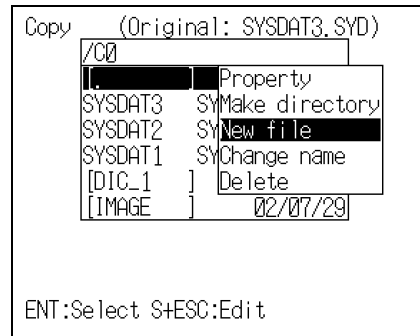

The software keyboard will be displayed.

6. Set the file name with up to 8 characters.



CHECK!

Periods (.) cannot be used in file name.

7. Move the cursor to **END** and press the **ENT** Key.

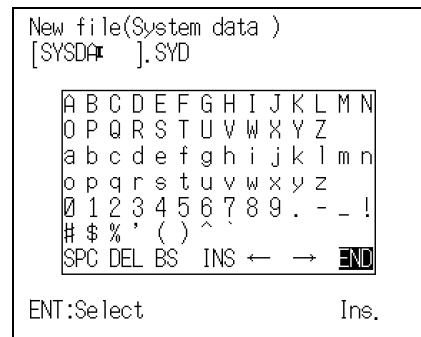

The confirmation message will be displayed.

8. Select **Execute**.



The file will be copied and the screen in **2.** will return.

Checking File Properties

The size, type, or date a file was created can be checked.

1. Follow the procedure **1.** to **6.** for *Creating Directories* and display the list of file names.

 Refer to page 163.

2. Move the cursor to the file for which the information is to be checked and press the **SHIFT** + **ESC** Keys.

```
File operation
/CD
[.] 02/07/31
SYSDAT3 SYD 02/07/31
SYSDAT2 SYD 02/07/31
SYSDAT1 SYD 02/07/31
[IMAGE ] 02/07/29

ENT:Select S+ESC>Edit
```

▼
The edit menu will be displayed.

3. Select **Property**.

```
Property
Make directory
Change name
Delete
```

▼
The properties of the selected file will be displayed.

4. Select **End**.

```
File name :SYSDAT3.SYD
Type      :System data
Path      :/CD
Size      :                1 KB
Creation  :02/07/31 10:18:48

End
```

▼
The screen in **2.** will return.

Changing File Names

The file name in the Memory Card can be changed.



Only the file name can be changed. The directory name cannot be changed.

1. Follow the procedure **1.** to **6.** for *Creating Directories* and display the list of file names.

Refer to page 163.

2. Move the cursor to the file whose name is to be changed and press the **SHIFT + ESC** Keys.

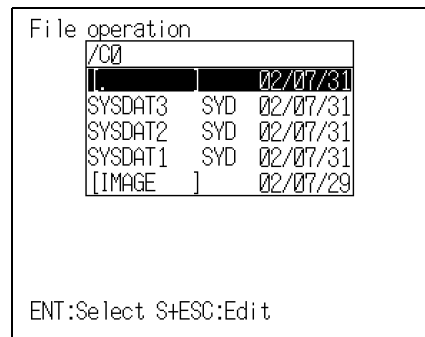

The edit menu will be displayed.

3. Select **Change name**.

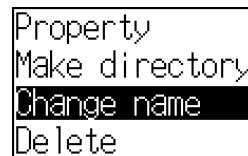

The software keyboard will be displayed.

4. Set the file name with up to 8 characters.



Periods (.) cannot be used in file name.

CHECK!

5. Move the cursor to **END** and press the **ENT** Key.

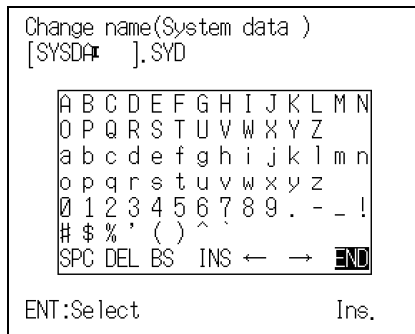

A confirmation screen will be displayed.

6. Select **Execute**.

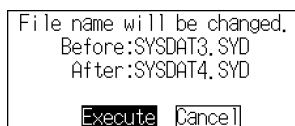

The file name will be changed and the screen in **2.** will return.

Deleting Files and Directories

1. Follow the procedure **1.** to **6.** for *Creating Directories* and display the list of file names.

 Refer to page 163.

2. Move the cursor to the file or directory to be deleted and press the **SHIFT + ESC** Keys.



CHECK! A directory can be deleted only when there are no files in that directory.

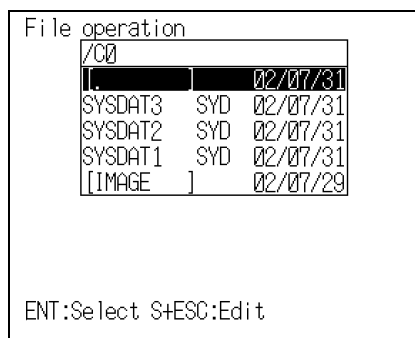

▼
The edit menu will be displayed.

3. Select **Delete**.



▼
The confirmation message will be displayed.

4. Select **Execute**.

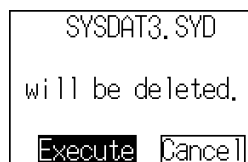

▼
The file or directory will be deleted and the screen in **2.** will return.

Turning OFF the Power Supply to the Memory Card

Turn OFF the power supply to the Memory Card before removing the Memory Card. If the power is not turned OFF before the Memory Card is removed, the Memory Card and the V530-R160 may be damaged.



The total space and free space on the Memory Card will be displayed on this screen.

1. Follow the procedure **1.** to **5.** for *Creating Directories* and display the **Copy file/File operation/Drive status** menu.



Refer to page 163.

2. Select **Drive status**.

```
Copy file
File operation
Drive status
```

The Drive status screen will be displayed.

3. If a Memory Card is inserted, **Inserted** will be highlighted. Change the display to **Stop**.



If a Memory Card is not inserted, the display will be **Not inserted**.

4. Select **End**.

```
Drive status

Drive C0 :Inserted
Free space Inserted
60593k Stop15KB

End
```

The confirmation message will be displayed.

5. Remove the Memory Card and press the **ENT** Key.

```
Memory card C0
can be removed safely.
Push ENT after remove it.

OK
```

The screen in **2.** will return.

Checking I/O Status with Host Devices (I/O Monitor)

Use the I/O monitor function to check the communications status via serial or parallel I/O interfaces. Wiring and communications settings can be checked.

Serial Interface

The communications status via the serial interface can be checked.

1. The **MON** (monitor) mode or **RUN** mode screen will be displayed.
2. Move the cursor to **MON** or **RUN** and press the **ENT** Key.

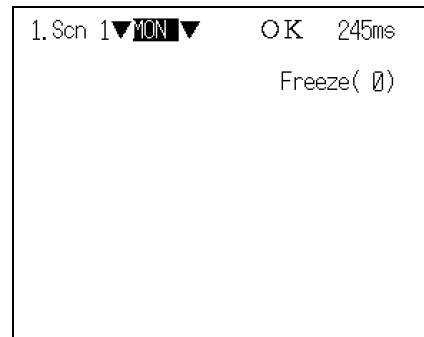

The mode selections will be displayed.

3. Select **TOOL**.

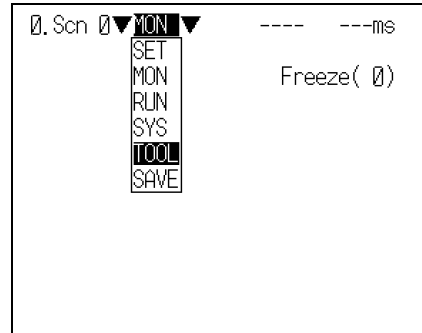

The TOOL mode selections will be displayed.

4. Select **I/O monitor**.

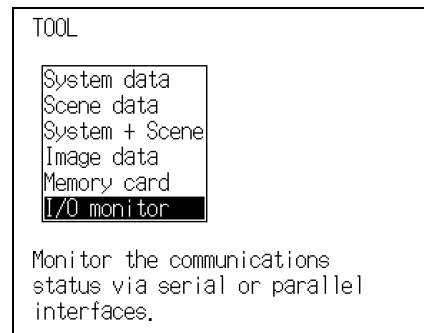

The interface selections will be displayed.

5. Select **Serial**.



The **Serial I/O monitor** screen will be displayed.

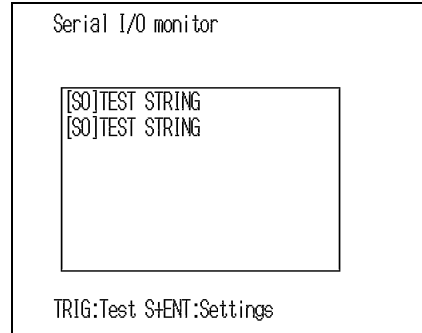

Display Details

Display	Meaning
SO	Output to host device. Press the TRIG Key once to send a test character string “ TEST STRING ” from the V530-R160 to the host device. The contents of the test character string can be changed. Refer to page 175.
SI	Input from host device. If more than 26 characters are received, only the first 26 characters will be displayed. If Echo back is set to ON, the received data will be returned as is to the host device. Refer to page 175.

6. Press the **ESC** Key to leave this screen.

The screen in **5.** will return.

■ Changing Test Character String and Echo Back

1. Display the **Serial I/O monitor** screen and press the **SHIFT + ESC** Keys.

▼
The detailed setting screen will be displayed.

2. Select **ON** or **OFF** for **Echo back**.

```
Echo back : ON▼
Test string : [TEST STRING ]
                End
```

3. Move the cursor to the square brackets [] and press the **ENT** Key.

▼
The software keyboard will be displayed.

4. Change the test string. Up to 12 characters can be inserted.
5. Select **END** and the screen in 2. will return.

```
Test string :
[TEST STRING ]

A B C D E F G H I J K L M N
O P Q R S T U V W X Y Z
a b c d e f g h i j k l m n
o p q r s t u v w x y z
0 1 2 3 4 5 6 7 8 9 . - _ !
# $ % ' ( ) ^ ?
SPC DEL BS INS ← → END

ENT:Select                               Ins.
```

6. Move the cursor to **End** and press the **ENT** Key.

▼
The Serial I/O monitor screen will return.

Parallel I/O Interface

The communications status via the parallel I/O interface can be checked.

1. The **MON** (monitor) mode or **RUN** mode screen will be displayed.
2. Move the cursor to **MON** or **RUN** and press the **ENT** Key.

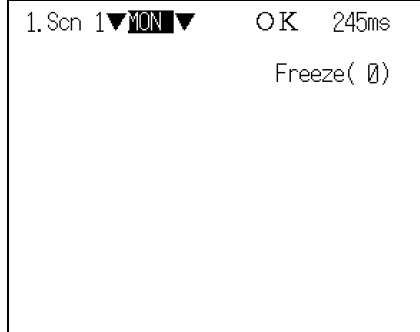

The mode selections will be displayed.

3. Select **TOOL**.

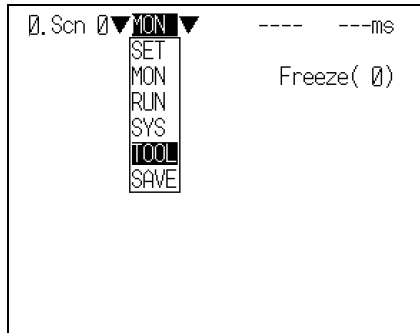

The TOOL mode selections will be displayed.

4. Select **I/O monitor**.

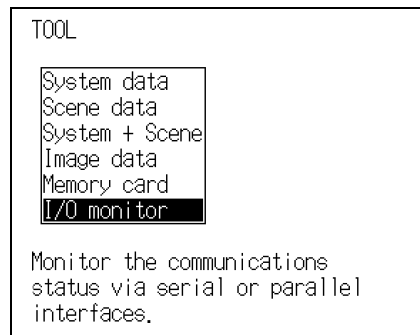

The interface selections will be displayed.

5. Select **Parallel**.



The Parallel I/O monitor screen will be displayed.

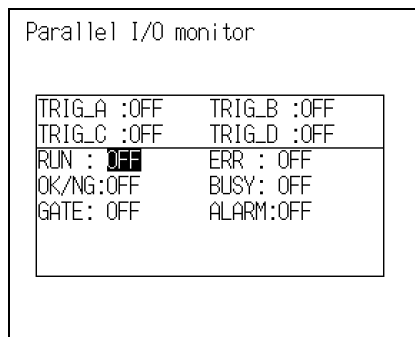

Display Details

Display	Meaning
TRIG A	Displays the input status for each signal from the host device to the V530-R160.
TRIG B	
TRIG C	
TRIG D	
RUN	Displays the output status for each signal from the V530-R160 to the host device. These displays can be changed to ON/OFF or 0/1 even if readings are not executed. Move the cursor to the display item. The display will be changed each time the ENT Key is pressed.
ERR	
OK/NG	
BUSY	
GATE	
ALARM	

6. Press the **ESC** Key to leave this screen.







The screen in **5.** will return.

MEMO

SECTION 7

System Settings

This section describes how to set conditions related to the system environment.
For details on communications specifications, see *SECTION 8 Communications with the Host*.

 Entering System Mode	180
 Settings Relating to the Camera and Monitor (Camera/Monitor)	181
 Selecting the Conditions for Image Storage (Image Storing)	182
 Setting Startup Conditions (Startup Mode)	186
 Using BUSY Signals (Error Method)	187
 Setting the Calendar Date and Time (Date/Time)	188
 Checking the Version (Version)	189

Entering System Mode

This section describes how to set conditions related to the system environment.
It is necessary to enter **SYS** (system) mode.

1. The **MON** (monitor) mode or **RUN** mode screen will be displayed.
2. Move the cursor to **MON** or **RUN** and press the **ENT** Key.

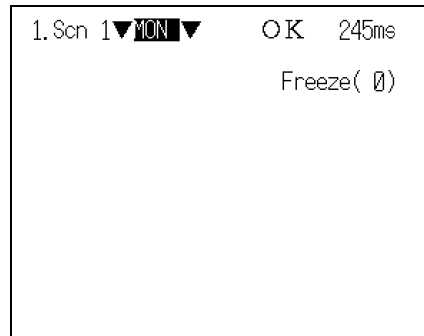

▼
The mode selections will be displayed.

3. Select **SYS**.

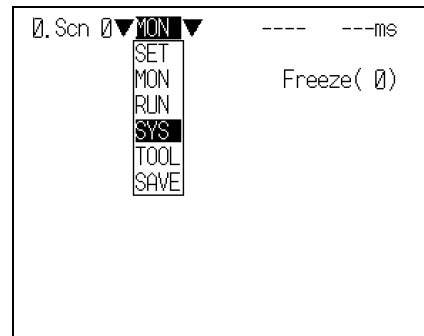

▼
The System mode screen will be displayed.

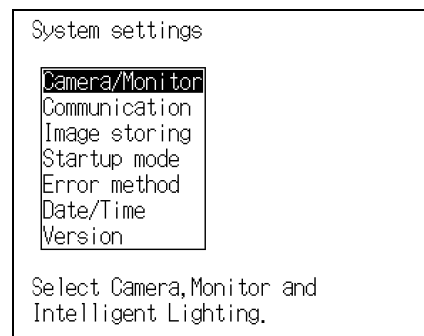

Settings Relating to the Camera and Monitor (Camera/Monitor)

Specify the model of the connected Camera and Intelligent Lighting (if using any).

If you have connected a color monitor, you can customize the display color.

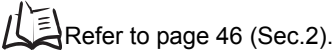
Menu item	Details
Intelligent Lighting 0 Intelligent Lighting 1	If a Camera with Intelligent Lighting is connected, select the model of the Intelligent Lighting. Always set the DIP switch on the Intelligent Lighting to OFF, regardless of the Camera number.  (LTC20*, Out of use)
Monitor	Select the model of the connected monitor. (Color*, Monochrome)
Color (Character color) (BG color)	If you have connected a color monitor, you can select the color of the displayed characters and the background color for the characters. (White, black, green, blue*, yellow* ... on shipping from the factory, the background color is blue and the character color is yellow.)

The asterisks (*) indicate the default settings.

1. Go into **SYS** (system) mode and select **Camera/Monitor**.

 Refer to page 180.

▼
The Camera/Monitor setting screen will be displayed.

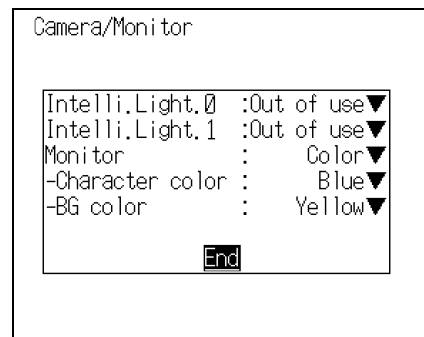

2. If using Intelligent Lighting, select **LTC20**.
3. Select the monitor type to be connected.
4. If you have connected a color monitor, select **Character color** and **BG color**.
5. Select **End**.



▼
The setting will be registered and the System mode screen will return.

Selecting the Conditions for Image Storage (Image Storing)

A function for saving read images regardless of the selected scene is provided. You can determine the cause of a reading error from the saved image, then adjust the reading conditions and check the result by reading the same image again. Images can be automatically backed up in a Memory Card. The read data currently displayed on the monitor can also be captured and saved in the Memory Card.

Menu item	Details
Storing condition	Select whether or not images read by the controller are saved. (OFF, Only NG*, All)  Refer to page 183.
Store to MemCard	Select whether or not images specified by the Storage condition are automatically backed up in the Memory Card. (OFF*, ON)  Refer to page 184.
Number of Images	Set the maximum volume of image data that can be backed up in the Memory Card. When this figure is exceeded, the storage count is cleared and the existing images are overwritten. (Range: 100* to 1000)
Capture display	Select whether or not the currently displayed content of the monitor screen is to be captured. (OFF*, ON)  Refer to page 185.

The asterisk (*) indicates the default setting.

1. Go into **SYS** (system) mode and select **Image storing**.



Refer to page 180.

▼
The screen for setting the method of image storage will be displayed.

2. Make the settings for each item.
3. Select **End**.

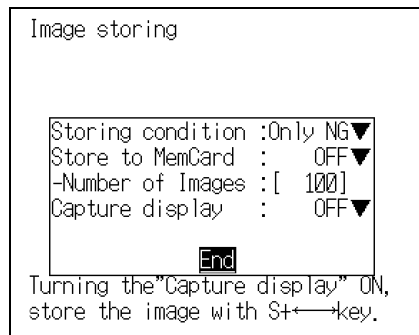

The setting will be registered and the System mode screen will return.



The stored images are cleared when the power is turned OFF.

CHECK!

The images must be backed up in the computer or in a Memory Card if you want to save them long term.



Refer to page 149 (Sec.6).

Image Storage Conditions

The V530-R160 can save up to 35 read images (Same for all scenes). The condition for saving the images can be selected as “saved only when the reading judgement is NG” or “all images saved regardless of the reading judgement.” When 35 images have been stored, new images will be stored by overwriting old images, starting with the oldest.

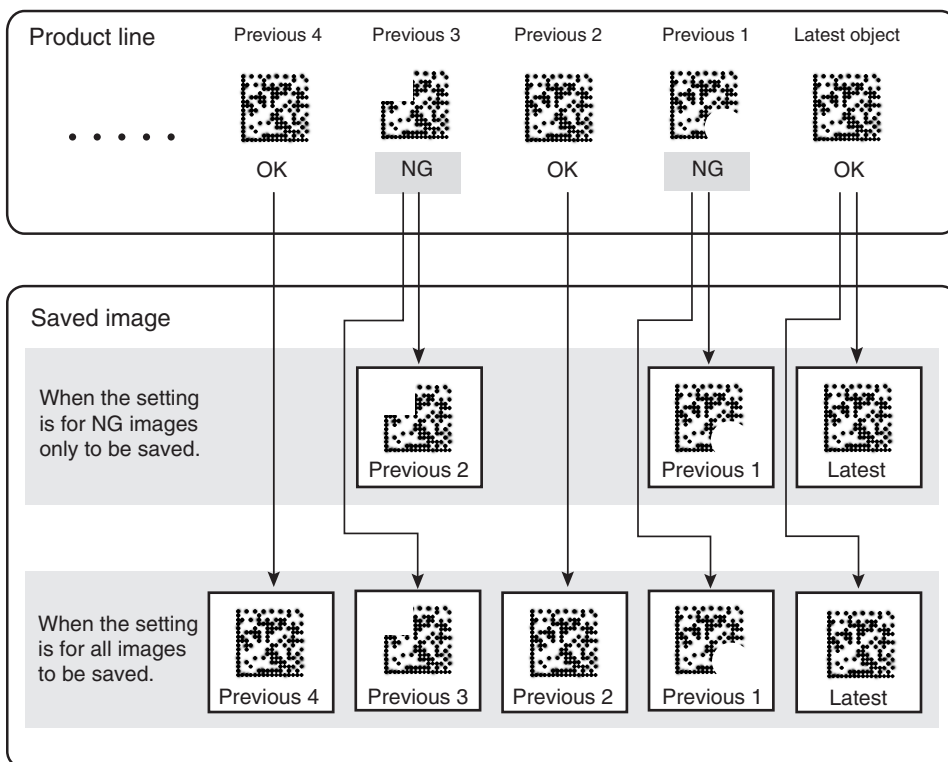

Even if **Only NG** is set as the image storage condition, the latest read image is saved.

CHECK!



Reading can be repeated for stored images.

CHECK!

Display the desired stored image using the **SHIFT + Up/Down** Keys and press the **SHIFT + TRIG** Keys to execute reading.

Reading can also be repeated for freeze images without re-inputting the image using the **SHIFT + TRIG** Keys. By reading an image again after adjusting the reading conditions, you can check if the conditions are appropriate.



CHECK!

On reading after setting the image storage condition (**Only NG/All**), images are saved in sequence from **memory 0**. When the scene is switched and reading of that scene starts, the existing data is overwritten starting from **memory 0**.



CHECK!

If reading conditions are set for a scene that has not been set, the camera image is saved in **memory 0**.

■ Storage in Memory Cards

When this function is turned ON, images that comply with the image storage conditions are automatically backed up in the Memory Card.

By checking the date and time that the file was created, you can determine when a reading NG event occurred.

By using NG images backed up in the Memory Card for pattern registration, you can improve the reading conditions.

A directory entitled “save” is automatically created in the root directory of the Memory Card. Image data is backed up in this directory.

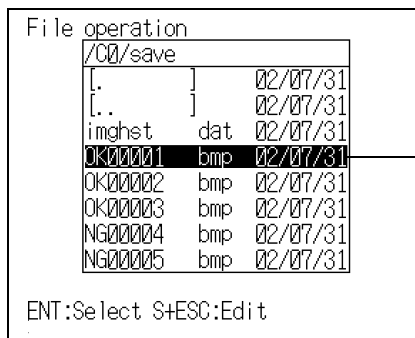

Image data is backed up under file names of the type indicated below.

OK00001.bmp

Judgment Result
(OK or NG)

Five-digit serial numbers
starting from “00000”



CHECK!

The number of files that can be backed up differs according to the capacity of the Memory Card. Use the following information as a guide.

Memory Card capacity	Number of saved files
64 MB	Up to 200
128 MB	Up to 400



CHECK!

When **Store to MemCard** is set to ON, the processing time is increased by approximately 2 seconds due to the image backup operation.

■ Display Captures

Turn ON the display capture function to capture the image displayed on the monitor and save it to the Memory Card.

Stored images can be pasted to documents on a personal computer or loaded to the V530-R160 and re-read.



CHECK!

The capture operation takes several seconds, during which reading cannot be performed. To prevent incorrect operation, set this function to **OFF**.

■ Execution keys

Capture a display by pressing **SHIFT + Left + Right** Keys simultaneously.

■ Display capture results

When a capture is executed, **capture in progress** will be displayed at the bottom right of the screen. After that, a directory called IMAGE will automatically be created in the root directory of the Memory Card and the following two types of files will be stored in that directory.

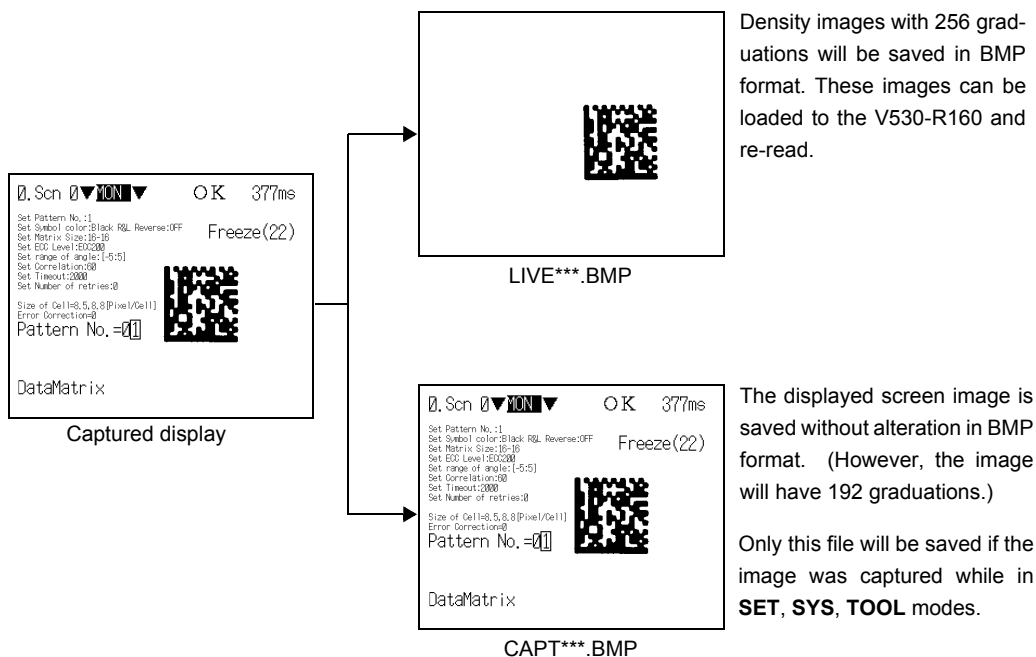

A serial number starting from 000 will be automatically allocated to ***. The same number is used for both files.

Setting Startup Conditions (Startup Mode)

Use the following procedure to set the status when the power is turned ON. If the V530-R160 is set to start in **RUN** mode for the scene where the desired reading conditions are registered, reading of objects can be started by simply turning the power ON.

Item	Details
Startup scene	Select the startup scene number. (Selection: 0* to 9)
Startup mode	Select the startup mode. (Selection: SET , MON* , RUN)
Language	Select the startup language. (Selection: Japanese*, English)

The asterisk (*) indicates the default setting.

1. Go into **SYS** (system) mode and select **Startup mode**.



Refer to page 180.



The Startup mode setting screen will be displayed.

2. Change the settings.
3. Select **End**.

Startup scene	:	0. Scn 0	▼
Startup mode	:	MON	▼
Language	:	English	▼
End			



The setting will be registered and the System mode screen will return.

Using BUSY Signals (Error Method)

The BUSY signal is a control signal used to show that the V530-R160 is busy processing. The ON/OFF timing of this BUSY signal is monitored at the host device to time communications. The handling of the BUSY signal can be changed to create a smoother system.

■ Input in the BUSY Status

While reading processing is in progress (while the BUSY signal is ON), the controller will not read image data even if TRIG A is input. Set whether or not the ERR signal is turned ON as notification that the host has not accepted a trigger.

Selection	Details
ERR ON*	When a TRIG A is input during processing (while the BUSY signal is ON), the ERR signal turns ON and reading is not performed. The ERR signal will turn OFF when the next TRIG A is input at the correct timing.
OFF	The ERR signal will not turn ON even if the TRIG A is input during processing. Reading will not be performed.

The asterisk (*) indicates the default setting.



The BUSY signal turns OFF when the reading has been completed.

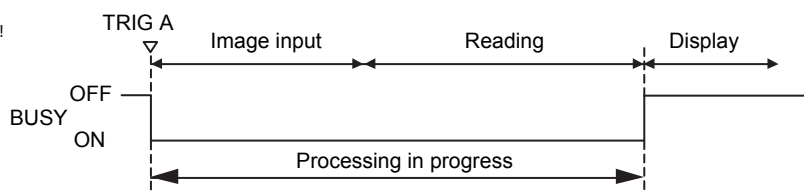

1. Go into **SYS** (system) mode and select **Error method**.



Refer to page 180.



The Error method setting screen will be displayed.

2. Change the settings.
3. Select **End**.

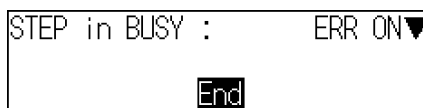

The setting will be registered and the System mode screen will return.

Setting the Calendar Date and Time (Date/Time)

Check if the internal calendar is set to the correct date and time and adjust if necessary.

1. Go into **SYS** (system) mode and select **Date/Time**.



Refer to page 180.

▼
The Date/Time setting screen will be displayed.

2. Check if the date and time is correct.

Adjust if necessary.

3. If the settings do not require adjustment, select **Cancel** to exit this screen.

Year	:	[2002]
Month	:	[7]
Day	:	[31]
Hour	:	[13]
Minute	:	[22]
Second	:	[20]
		<input type="button" value="Update"/> <input type="button" value="Cancel"/>

Select **Update** to save changes to the date and time.

▼
The setting will be registered and the System mode screen will return.

Checking the Version (Version)

Use the following procedure to check the model of Controller and the software system version.

1. Go into **SYS** (system) mode and select **Version**.



Refer to page 180.

▼
The Version information will be displayed.

Select **OK** to validate the settings and leave this screen.



▼
The System mode screen will return.

MEMO

SECTION 8

Communication with the Host

This section describes how to connect host devices through a parallel I/O or serial interface and explains I/O formats.

▣ Parallel I/O	192
Setting Communications Specifications	192
Trigger Input and Output Formats	194
Timing Charts	195
System Examination	200
▣ Serial Interface (Normal)	202
Flow Charts	203
Setting Communications Specifications	206
Command List	212
I/O Format	212
Command Format	216
Connection Examples for Programmable Controller (Normal)	229
▣ Serial Interface (Host Link)	232
Flow Charts	233
Setting Communications Specifications	236
I/O Format	240
Connection Examples for Programmable Controller (Host Link)	244

Parallel I/O

Setting Communications Specifications

This section explains how to set the communications specifications. The same communication settings must be used on both the V530-R160 and the host device.

1. Move the cursor to **RUN** or **MON** and press the **ENT** Key.
2. Select **SYS**.

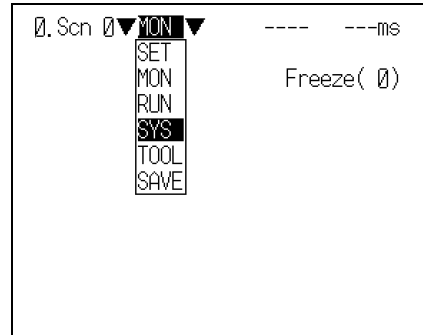

▼
The System settings screen will be displayed.

3. Select **Communication**.

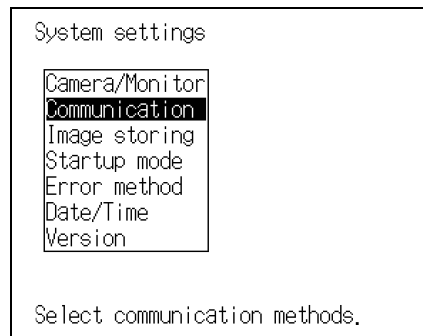

▼
The selections will be displayed.

4. Select **Parallel**.

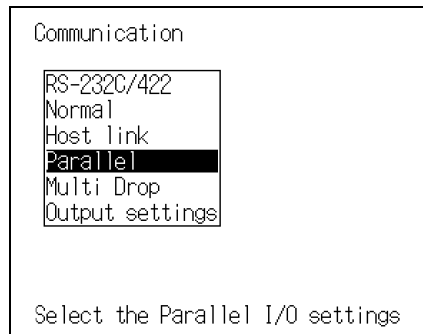

The screen for setting the communications specifications will be displayed.

- 5.** Make the settings for each item.
- 6.** Select **End**.

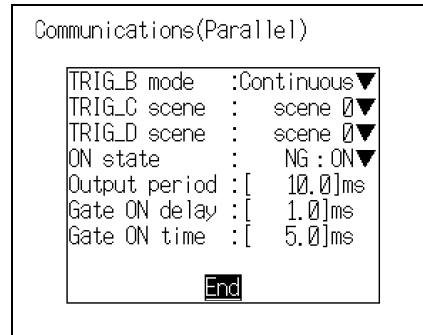

The setting will be registered and the screen in **4.** will return.

Communications Specifications

Item	Description	
TRIG B mode (TRIG B)	Select continuous reading or reading until OK judgement output.	
	Continuous reading (default setting)	Performs continuous reading while the TRIG B terminal is ON. TRIG B input invalidates the Reading Settings/Number of Retries setting.
	Level trigger	Repeats reading until an OK (readable) reading judgement is output while the TRIG B terminal is ON. In the case of an NG (not readable) reading, the NG signal is output when the TRIG B is turned OFF.
TRIG C mode (TRIG C)	Switches to the set scene number and reading is executed with the "level trigger" specification. (Scene 0 to 9; default setting: Scene 0)	
TRIG D mode (TRIG D)	Switches to the set scene number and reading is executed with the "level trigger" specification. (Scene 0 to 9; default setting: Scene 0)	
ON state	Select whether the OK/NG signal is turned ON when the judgement result is OK or when it is NG.	
	NG: ON (default setting)	The OK/NG signal is turned ON for an NG reading.
	OK: ON	The OK/NG signal is turned ON for an OK reading.
Output period	Set the output period for reading judgement. Set a value between 2.0 and 10000.0 ms that is greater than the "Gate ON delay + Gate ON time", and less than the reading interval. If the cycle is longer than the reading interval, the output timing will fall behind as the readings are repeated. (2.0 to 10000.0 ms; default setting: 10.0 ms)	
Gate ON delay	Set the time from parallel I/O result output to turning ON of the GATE signal. This time is used to wait until the data output becomes stable. Set a time between 1.0 and 1000.0 ms that is longer than the delay time for the host device. (1.0 to 1000.0 ms; default setting: 1.0 ms)	
Gate ON time	Set the time during which the GATE signal is ON. Set the time required for the host to input the reading result. (1.0 to 1000.0 ms; default setting: 5.0 ms)	





About trigger input, refer to page 194.

Trigger Input and Output Formats

■ Trigger Input

The trigger inputs are TRIG A, TRIG B, TRIG C, and TRIG D. In the **MON/RUN** mode, reading is executed in accordance with input to these signals.

Signal	Description				
TRIG A (One shot reading)	<p>One reading against the currently displayed scene is performed on the rising edge (OFF to ON) of the TRIG A signal.</p> <p>Correct Reading: Reading ends, then reading judgement is output.</p> <p>Incorrect Reading: Reading continues to be performed for the number of retries specified in Reading settings/Number of Retries.</p> <p> Setting the Number of Retries: Refer to page 112 (Sec.5).</p> <p>As the TRIG A signal is synchronous with the shutter input of the Camera, an accurate image of the moving object can be obtained.</p>				
TRIG B (Continuous reading/Level trigger)	<p>The currently displayed scene is either continuously read or read until an OK reading judgement.</p> <p>TRIG B input invalidates the Reading Settings/Number of Retries setting.</p> <p>TRIG B changes in the way shown below in accordance with the trigger mode in the communications setting menu.</p>				
	<table border="1"> <tr> <td>Continuous reading</td> <td>Performs continuous reading while the TRIG B terminal is ON.</td> </tr> <tr> <td>Level trigger</td> <td>Repeats reading until an OK (readable) reading judgement is output while the TRIG B terminal is ON. In the case of an NG (not readable) reading, the NG signal is output when the TRIG B is turned OFF.</td> </tr> </table>	Continuous reading	Performs continuous reading while the TRIG B terminal is ON.	Level trigger	Repeats reading until an OK (readable) reading judgement is output while the TRIG B terminal is ON. In the case of an NG (not readable) reading, the NG signal is output when the TRIG B is turned OFF.
	Continuous reading	Performs continuous reading while the TRIG B terminal is ON.			
Level trigger	Repeats reading until an OK (readable) reading judgement is output while the TRIG B terminal is ON. In the case of an NG (not readable) reading, the NG signal is output when the TRIG B is turned OFF.				
TRIG C	<p>Switches to the scene set in the communications setting menu and executes reading. Use this function when you want to automatically switch between scenes and read them, for example when two cameras are connected.</p> <p> Refer to page 192.</p>				
TRIG D	<p>Switches to the scene set in the communications setting menu and executes reading. Use this function when you want to automatically switch between scenes and read them, for example when two cameras are connected.</p> <p> Refer to page 192.</p>				

■ Output Format

Every time reading is executed a reading result is output.

Output only occurs in the **RUN** mode. There is no output in the **MON** mode.

Signal	Description	
OK/NG	OK	OK when 2-dimensional codes are read successfully. The reading data is output to the host via the serial interface.
	NG	NG when 2-dimensional codes are not read successfully. Error codes are output to the host via the serial interface.

NOTICE

The initial status of the output signals is OFF. However, the signals may turn ON for approximately 0.5 seconds when the power is turned ON.

Take care with regard to signal input at the host.

■ Timing Charts

■ One Shot Reading

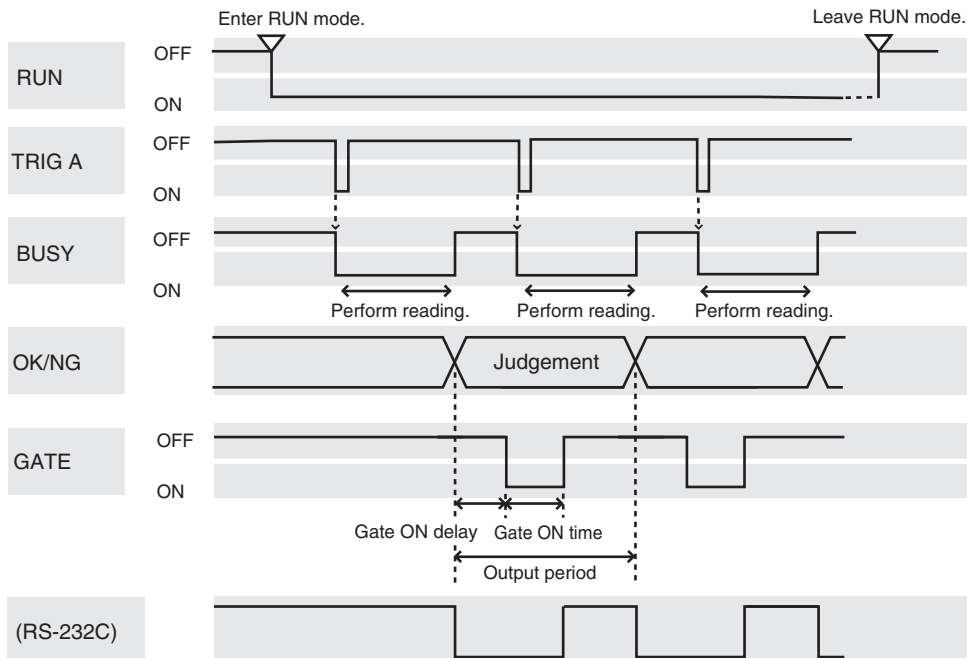

Note: The output time to RS-232C changes depending on the data volume and baud rate.

Output signal

Output signal	Function
RUN	Turns ON during RUN mode.
BUSY	Shows that the V530-R160 is reading an image, changing settings, etc. Do not input the next command while the BUSY signal is ON. Otherwise, the commands input during command execution or processing may not be properly executed.
OK/NG	Outputs the judgement under the set reading conditions. (Can be set to turn ON for either OK or NG judgement.)
GATE	Used to control the timing with which the reading judgement is read at the host device. The duration for which the GATE terminal is turned ON can be set as required for the host device to correctly read the reading judgement. Make the output cycle longer than the gate ON delay plus the gate ON time, but shorter than the duration of the reading (TRIG A input). If the cycle is longer than the duration of the reading, the input timing falls behind as readings are repeated. Gate ON delay, Gate ON time and Output period are set under the set communications conditions.  Refer to page 192.

Input signal

Signal	Function
TRIG A	The reading trigger is input from a device such as a photoelectric switch. One reading is performed on the rising edge (OFF to ON) of the TRIG A signal. Turn ON for at least 0.5 ms. The duration of TRIG A signal input depends on reading time. While reading is being performed, the BUSY signal turns ON and input signals are not accepted. Refer to System Examination for the standard reading time.  Refer to page 200.

■ **Continuous Reading (When Trigger Mode is [Continuous Reading])**

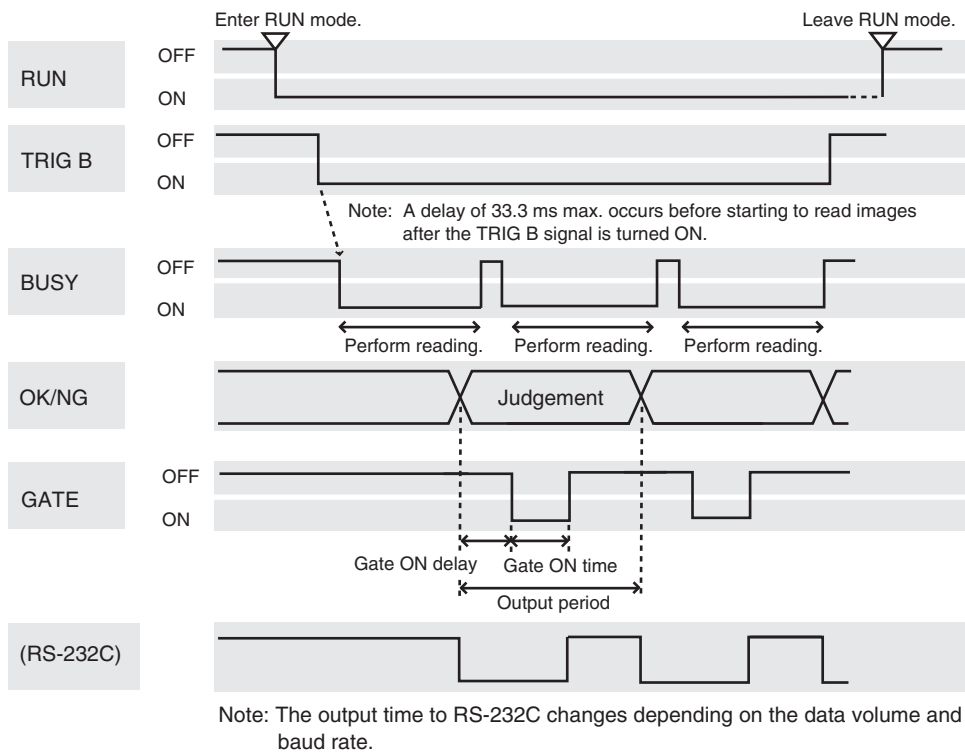

Output signal

Output signal	Function
RUN	Turns ON during RUN mode.
BUSY	Shows that the V530-R160 is reading an image, changing settings, etc. Do not input the next command while the BUSY signal is ON. Otherwise, the commands input during command execution or processing may not be properly executed.
OK/NG	Outputs the judgement under the set reading conditions. (Can be set to turn ON for either OK or NG judgement.)
GATE	Used to control the timing with which the reading judgement is read at the host device. The duration for which the GATE terminal is turned ON can be set as required for the host device to correctly read the reading judgement. Make the output cycle longer than the gate ON delay plus the gate ON time, but shorter than the duration of the reading (TRIG A input). If the cycle is longer than the duration of the reading, the input timing falls behind as readings are repeated. Gate ON delay, Gate ON time and Output period are set under the set communications conditions.

Refer to page 192.

Input signal

Signal	Function
TRIG B	Performs continuous reading while the TRIG B terminal is ON.

■ **Continuous Reading (When Trigger Mode is [Level Trigger])**

- When the reading is performed correctly:

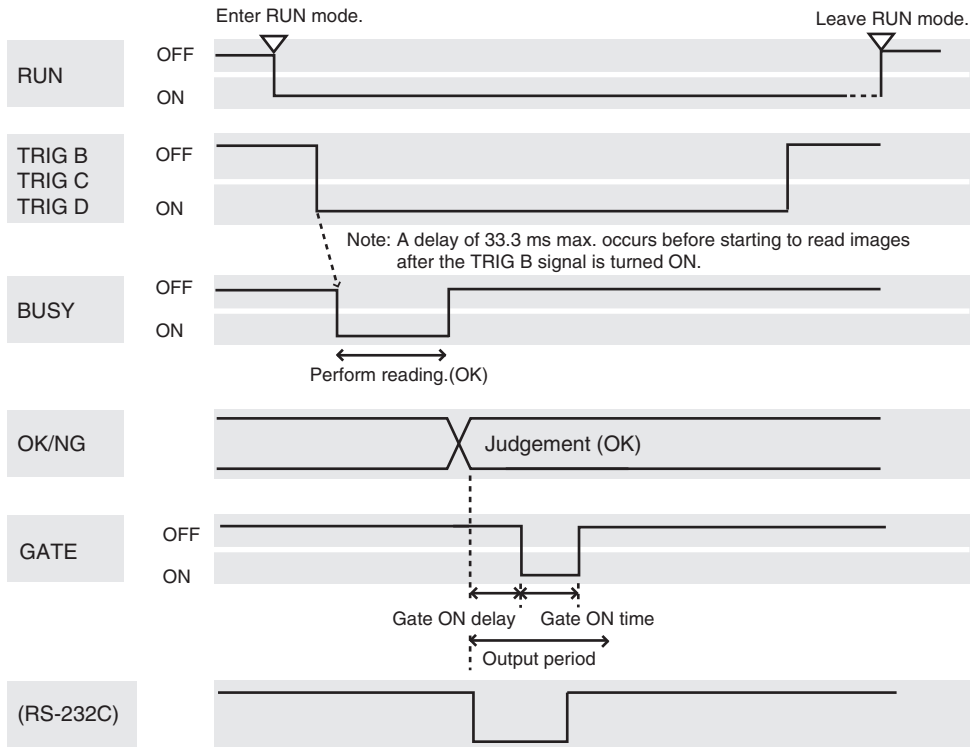

Note: The output time to RS-232C changes depending on the data volume and baud rate.

Output signal

The function of the signal is the same as for continuous reading (when the trigger mode is set to [Continuous Reading]).

Input signal

Signal	Function
TRIG B	Repeats reading until an OK (readable) reading judgement is output while the TRIG B terminal is ON.
TRIG C	Repeats reading until an OK (readable) reading judgement is output while the TRIG C terminal is ON.
TRIG D	Repeats reading until an OK (readable) reading judgement is output while the TRIG D terminal is ON.

- OK judgement obtained after repeated reading:

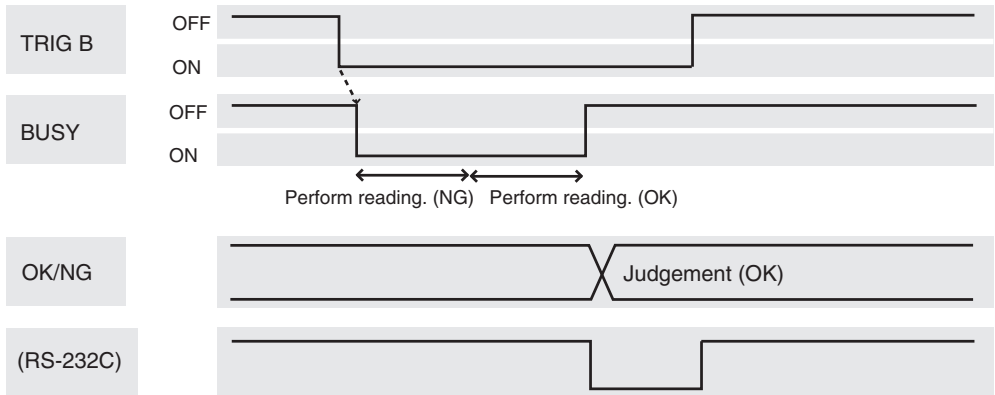

Note: The output time to RS-232C changes depending on the data volume and baud rate.

- NG judgement after repeated reading:

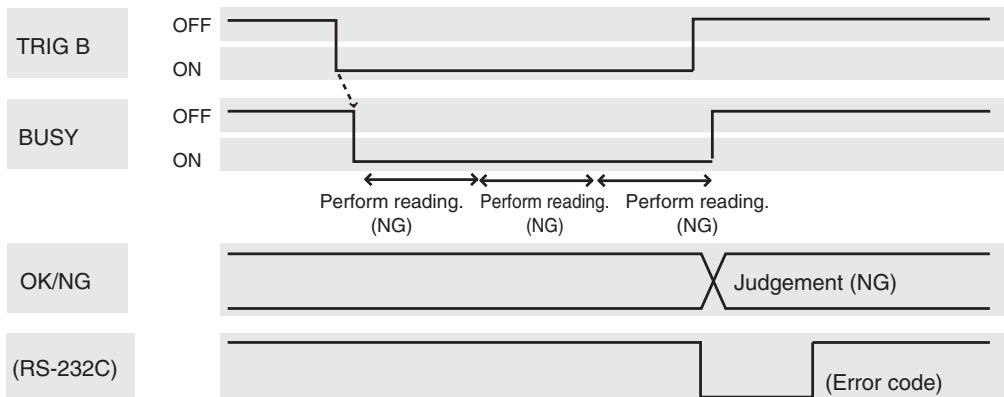

Note: The output time to RS-232C changes depending on the data volume and baud rate.

System Examination

■ Processing Time Calculation

Processing time (reading time) is calculated as follows:

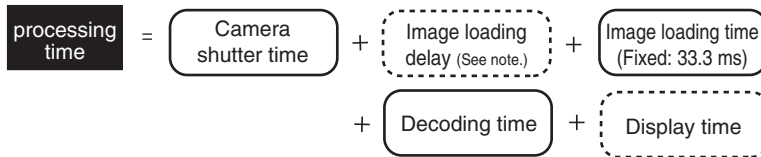

Note: When a through image is displayed, and depending on the trigger input method, there may be a delay of up to 33.3 ms between trigger input and the start of image loading.

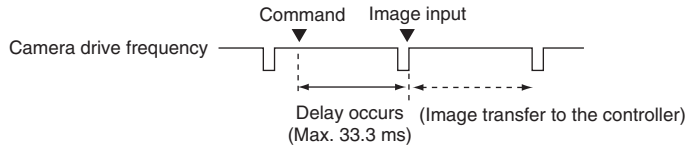

■ Reading Moving Objects

When reading a moving object, problems such as a drop in the reading percentage are likely to occur, and therefore due attention must be paid to the following points.

Please note the following to prevent delay when loading images.

- Use the TRIG A signal for timing input.

As the TRIG A signal is synchronous with the shutter input of the Camera, an accurate image of the moving object can be obtained.

- Set the image to be displayed on the monitor to **Freeze**.

When through images are displayed, a delay of 33.3 ms max. occurs before loading images after the TRIG A signal input.

▪ **Line speed**

If the object moves while the image is being loaded after the shutter is released, the image will be blurred. Fix the speed of the line by taking factors such as the shutter speed (which can be changed in the setting menu), the cell size for the object, and the field of vision of the camera into account.

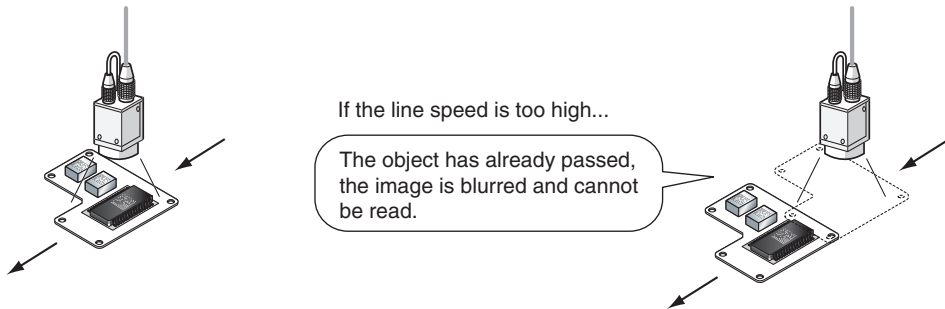

▪ **Tact time**

A certain interval is necessary between reading objects during which the next trigger signal is not input. This interval (time) is called Tact Time.

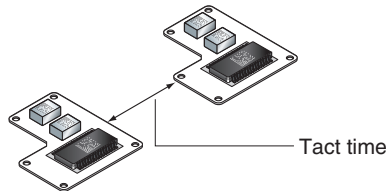

Example: Processing time for reading: 500 ms; Line speed: 30 m/min.

$$\frac{30 \text{ (m/min)}}{60 \text{ (sec)}} \times 0.5 \text{ (sec)} = 0.25 \text{ (m)}$$

The distance moved in 500 ms is 0.25 m. Therefore, an interval allowing 0.25 m min. of movement is necessary.

▪ **Number of retries**

If reading is NG, reading continues to be performed for the number of retries specified by the setting conditions. When reading moving objects, reading may continue after the object has left the field of vision.



Refer to page 112 (Sec.5).

■ **Level Trigger Reading**

For timing input, use TRIG B, TRIG C, and TRIG D.

Regardless of the displayed image (through/freeze), a 33.3 ms max. delay occurs before loading the image after a TRIG signal is input.

Serial Interface (Normal)

Communications with a host such as a personal computer or programmable controller are performed in no-protocol format via the serial interface. Set the **SYS/Communication/RS-232C/422** mode to **Normal**.



Refer to page 206.

- **SET** mode
Command input is not accepted.

- **MON** mode
Command input is accepted, but the reading results are not output to the serial interface. They are just confirmed on the monitor.

- **RUN** mode
Possible to input commands and output the reading results.

Flow Charts

■ When the Serial Interface is used for both Input and Output

1:1 connection or 1:N (multi drop) connection is possible.

■ 1:1 connection

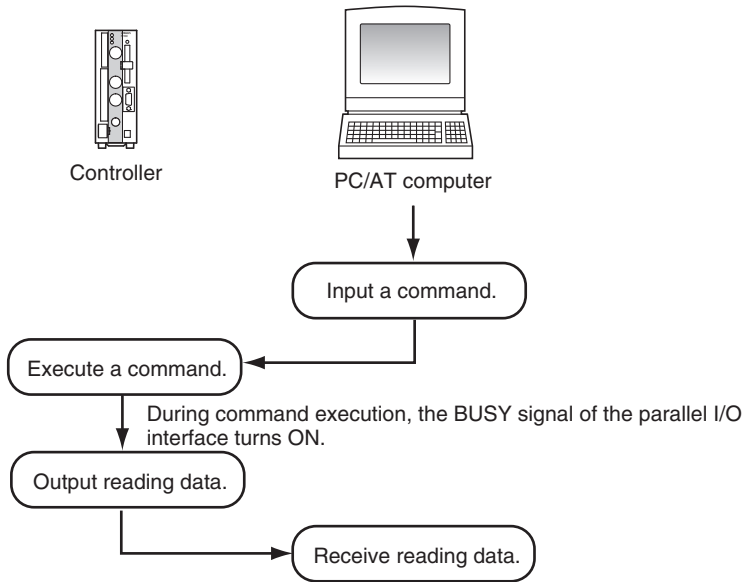

* When **Xon/off** is selected for flow control
 A timeout error occurs if there is no response from the host computer within the set time when **Xon/off** is selected for flow control, and it is assumed that the line is broken or the computer is not working correctly. The controller displays an error message on the screen and turns the ERR signal of the parallel I/O interface ON.

■ Program Examples

100 CLOSE #1	
110 OPEN "COM:E73NN" AS #1	'Communications port OPEN status
120 PRINT #1, "@GL"+CHR(&H0D)	'One shot reading command transmission
130 INPUT #1, RESDATA\$	'Loading data (with Footer code CR)
140 PRINT "READ DATA=" RESDATA\$	'Displaying reading data
150 GOTO 120	'Repeat
160 END	

▪ 1:N (Multi Drop) connection

Using a branching link adapter, one host can communicate with multiple controllers (up to 31). The unit number is attached to the prefix of all communication data, so set a different unit number for each V530-R160.



Refer to page 209.

After the V530-R160 reads a code, it holds the data without outputting it.

To output the data, issue a polling command.

Note that when the data is output, the controller performs the next reading operation and the previously read data is overwritten.

Example:

Input a command to controller No. 01 and obtain the result.

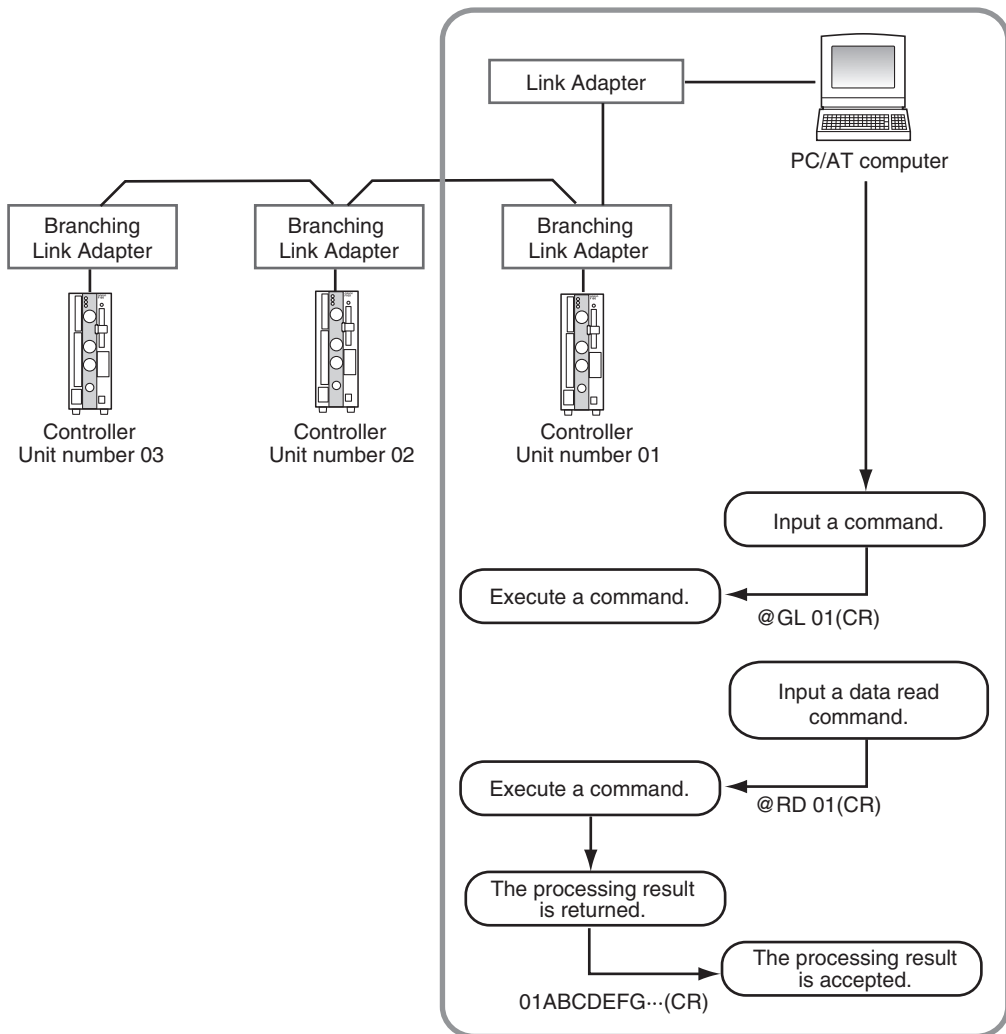

■ TRIG A Signal as Reading Trigger

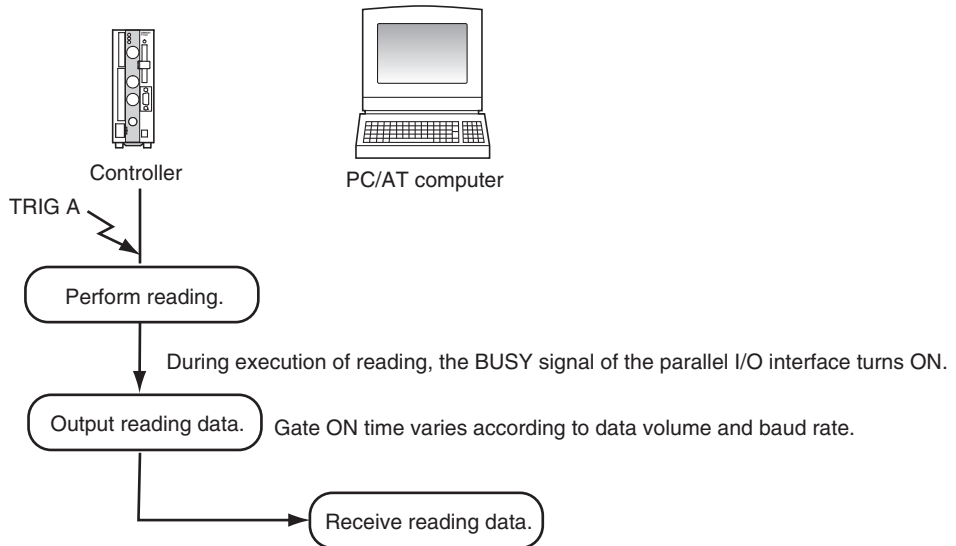

* When **Xon/off** is selected for flow control
 A timeout error occurs if there is no response from the host computer within the set time when **Xon/off** is selected for flow control, and it is assumed that the line is broken or the computer is not working correctly. The controller displays an error message on the screen and turns the ERR signal of the parallel I/O interface ON.

Setting Communications Specifications

This section explains how to set the communications specifications. The same communication settings must be used on both the V530-R160 and the host device.

1. Move the cursor to **MON** or **RUN** and press the **ENT** Key.
2. Select **SYS**.

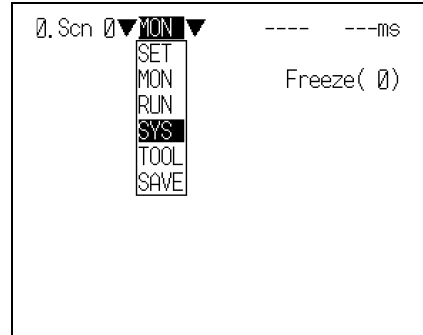

▼
The System settings screen will be displayed.

3. Select **Communication**.

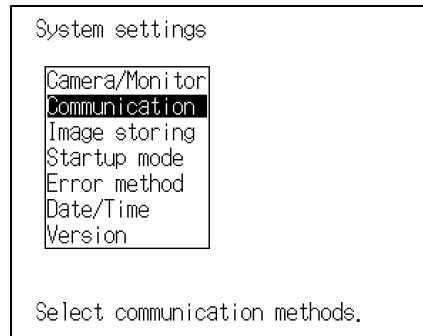

▼
The selections will be displayed.

4. Select **RS-232C/422**.

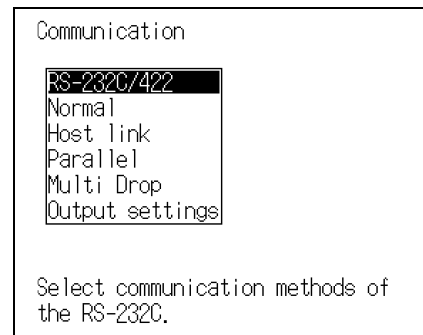

The screen for setting the communications specifications is displayed.

- 5.** Make the settings for each item.
- 6.** Select **End**.

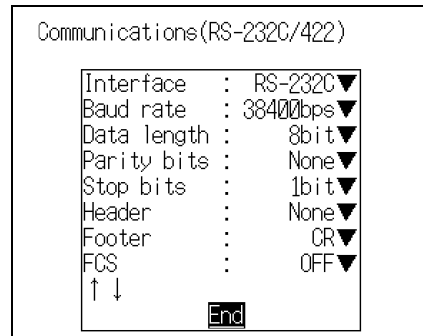

The setting will be registered and the screen in **4.** will return.

Set items and their details

Item	Selection	
Interface	RS-232C*, RS-422	
Baud rate (See note 1.)	2400, 4800, 9600, 19200, 38400*, 57600, 115200 (bps)	Set the same settings as those set for the personal computer.
Data length	7, 8* (bit)	
Parity bits	None*, Odd, Even	
Stop bits	1*, 2 (bit)	
Header	None*, STX, ESC	
Footer	CR*, LF, CR+LF, ETX	
FCS	OFF*, ON	
Mode	Select Normal . (Normal*, Host link)	
Protocol (See note 2.)	XMODEM*, ZMODEM	

The asterisk (*) indicates the default setting.

Note 1: Since communications speeds higher than 20 kbps are not defined with the RS-232C standard, depending on the cable length, if **38400 bps** or a higher setting is selected it may not be possible to perform communications properly. If this happens, change the setting to **19200 bps** or lower.

Note 2: The XMODEM (-1K) protocol is not supported.



Make the following settings when using the save and load commands (@CL, @CS, etc.)

Item	Setting
Data length	8 bits
Parity bits	None
Stop bits	1 bit
Flow control	None

Refer to page 208.

■ **Flow Control Settings**

Set the flow control and timeout time when communicating in the **Normal** mode with a host such as a personal computer.

1. Select **Normal** on the communications specifications setting screen.

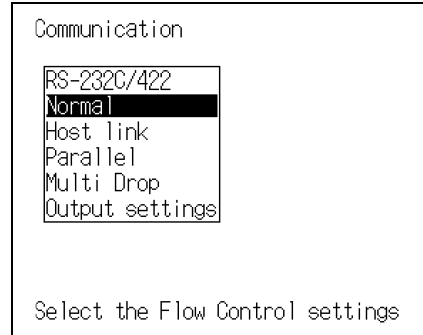

▼
 The Normal setting screen will be displayed.

2. Make the settings for each item.
3. Select **End**.

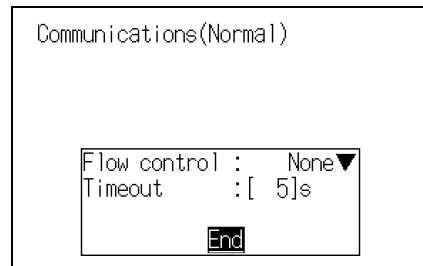

▼
 The setting will be registered and the screen in **1.** will return

Set Items and their details

Item	Selection	
Flow control	None*	No flow control is performed.  If using the save and load commands (@CS, @CL, etc.), select None . CHECK!
	Xon/Xoff	The software performs flow control. Data is transmitted in accordance with the Xon/Xoff code sent from the host.
Timeout	Set the number of seconds (1 to 120 seconds) before a timeout error occurs. (1 to 120 s; default setting: 5 s)	

The asterisk (*) indicates the default setting.



Flow control

Communications are carried out while checking the status of the host. If there is no response from the host for longer than the set timeout time, a timeout error occurs, and an error message is displayed on the screen.

The parallel I/O error signal also turns ON.

■ Multi Drop Settings

Set whether the multi drop function is to be used or not, and the unit numbers assigned to the controllers.

The unit number is attached to the prefix of all communication data, so set a different unit number for each V530-R160. A V530-R160 will not respond to a command with a unit number other than the one assigned to it.

- 1.** Select **Multi Drop** on the communications specifications settings screen.

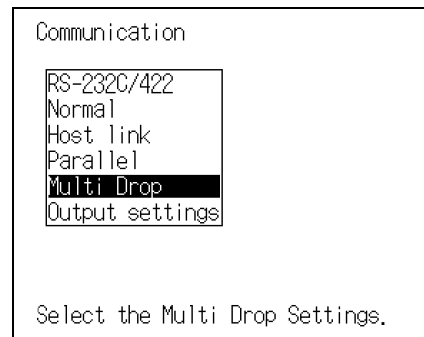

▼

The Multi drop setting screen will be displayed.

- 2.** Make the settings for each item.
- 3.** Select **End**.

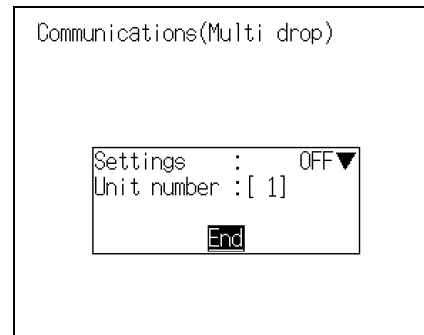

▼

The setting will be registered and the screen in **1.** will return.

Set Items and their details

Item	Selection	
Multi drop	OFF*	No Multi drop is performed.
	ON	Multi-drop connections are used. When "ON" is set, even if reading processing is executed the results will not be output to the serial interface automatically. The results will be output when a Send Data instruction (Polling Command) is sent from the host.
Unit number	Set the unit numbers of the controllers. (1 to 31; default setting: 1)	

The asterisk (*) indicates the default setting.

■ Settings for Data Output

Set the method for data output to the host.

1. Select **Output settings** on the communications specification setting screen.

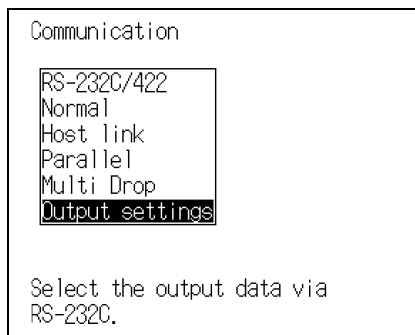

▼
The setting screen will be displayed.

2. Make the settings for each item.
3. Select **End**.

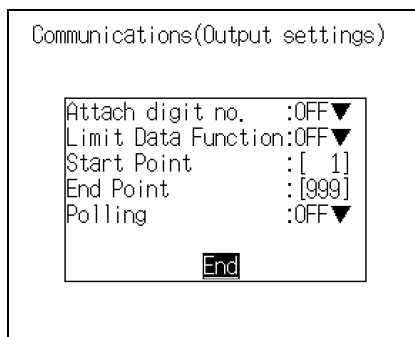

▼
The setting will be registered and the screen in **1.** will return.

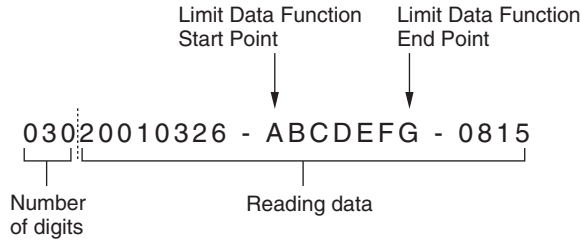

Set Items and their details

Item	Selection	
Attach digit no.	OFF*	The number of digits of the reading data is not output.
	ON	The number of digits of the reading data is output. The number of digits is shown in bytes. • A letter or a number is 1 digit.
Limit Data Function	OFF*	All of the reading data is output.
	ON	The specified range of reading data is output. Specify the data output range with Start Point and End Point . <div style="text-align: center;"> <p style="text-align: center;">Example: 030:20010326 - ABCDEFG - 0815</p> <p style="text-align: center;">Start Point: [4] End Point: [8]</p> </div>
Start Point	When ON is set for Limit Data Function , set the Start Point of the data to be output. The start number is counted from the beginning of the reading data. The number of digits is not included. (1 to 999; default setting: 1)	
End Point	When ON is set for Limit Data Function , set the End Point of the data to be output. The end number is counted from the beginning of the reading data. The number of digits is not included. (1 to 999; default setting: 999)	
Polling	OFF*	The reading data will be output to the host immediately after it is read.
	ON	When the V530-R160 is connected with a 1:1 connection, use the polling command to control the timing of reading data outputs. Reading data is output when a polling command is input.

The asterisk (*) indicates the default setting.

Command List

Command List

- 1:1 connection

- Instructing operations at the controller

These are the commands used to instruct the controller to perform operations such as reading or changing the scene.

Command	Function	Page
@GL	Performs one reading.	p.216
@GC	Starts continuous reading.	p.216
@SC	Stops continuous reading.	p.217
@RD	Outputs reading data to the serial interface. (Polling)	p.217
@RL	Outputs reading data to the serial interface. (Polling with digit position specified)	p.218
@SN	Obtains the scene number of the currently displayed scene.	p.218
	Switches to the specified scene number.	p.219
@DC	Switches the display status (through/freeze) of the image.	p.219
@MC	Switches between the MON mode and the RUN mode.	p.220
@MT	Obtains the processing time.	p.220
@SV	Saves the setting details in the flash memory.	p.221
@VR	Reads the system's version information.	p.221

- Saving and loading data

These commands back up the data and saved images set at the controller in the host.

Command	Function	Page
@AL	Loads the system and scene data from the host.	p.222
@AS	Saves the system and scene data to the host.	p.222
@BL	Loads the image data from the host.	p.223
@BS	Saves the image data to the host.	p.223
@CL	Loads the scene data from the host.	p.224
@CS	Saves the scene data to the host.	p.224

- 1:N connection (commands used in multi drop operation)

Command	Function	Page
@GL	Performs one reading.	p.216
@RD	Outputs reading data to the serial interface. (Polling)	p.217
@MS	Obtains the scene number of the currently displayed scene.	p.226
	Switches to the specified scene number.	p.226

I/O Format

Input Format (Command Format)

The following commands can be input from the host to the controller.

Match the communications specifications of the controller and the host in advance.

- 1:1 connection

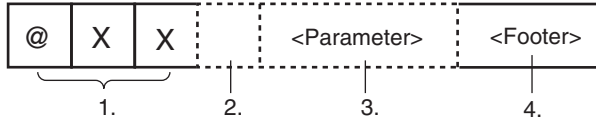

1. Specifies the name of the command.
2. Insert one space. (A blank box indicates that a space must be inserted.)
3. Specification is required here for some of the commands input in the boxes indicated by number (1). Make numerical or other settings if necessary.
4. Input the <Footer> at the end of a command.

- 1:N (multi drop) connection

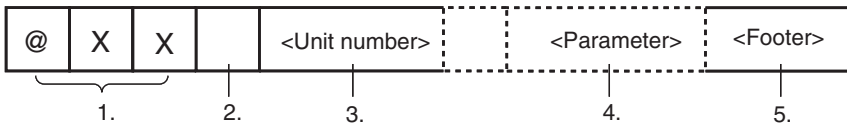



1. Specifies the name of the command.
2. Insert one space. (A blank box indicates that a space must be inserted.)
3. In a 1:N (multi drop) connection, set the unit number (01 to 31) of the controller the command is to be sent to.
4. Specification is required here for some of the commands input in the boxes indicated by number (1). Make numerical or other settings if necessary.
5. Input the <Footer> at the end of a command.

For details on the format for each command, refer to *Command Format*.

■ Output Format for Reading Data

The output format for the reading data is shown here.

A setting can be made to add or not add the boxes that are written with dashed lines .

- **SYS/Communication/RS-232C/422**  Refer to page 206.
- Setting whether or not to add the header and FCS.
- Selecting the footer.
- **SYS/Communication/Data Output Settings**  Refer to page 210.
- Setting whether or not to use polling commands to control the output timing.
- Setting whether or not to add digits.

■ 1:1 connection

• Reading OK

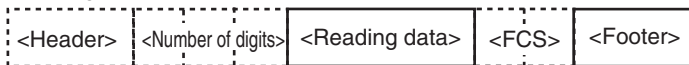

A setting can be made to add or not add the boxes that are written with dashed lines .

• Reading NG

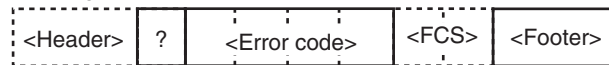

For error code details, refer to *Error Codes and Countermeasures* on p.253 in *Section 9, Troubleshooting*.

■ 1:N connection (using multi drop)

• Reading OK



The unit number of the controller that output the reading data

• Reading NG

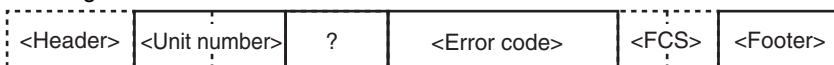

* The data will not be output for the 1:N (multi drop) connection unless the polling command (@RD) is executed.

Command Format

- 1:1 connection

@ GL

Function ••• Performs one reading. Reading ends when the reading is correctly performed (OK). When the reading is not correctly performed (NG), reading continues to be performed for the number of retries specified in the setting conditions.

Send @ G L <Footer>

Receive See Output Format

 Refer to page 227.

An error will occur if menu items are not registered.

<Header> E R <Footer>

@ GC

Function ••• Performs continuous reading until the stop command (@SC) is sent.

 Refer to page 217.

Send @ G C <Footer>

Receive See Output Format

 Refer to page 227.

@SC

Function ••• Stops continuous reading.

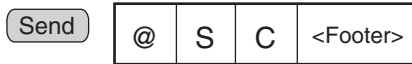

@RD

Function ••• Outputs the latest reading data to the serial interface. (Polling Command)



Receive See Output Format.



Refer to page 227.

An error will occur if reading has not been performed since the menu items were registered.



@RL

Function . . . Outputs the data corresponding to the specified digit position to the serial interface.
(Polling command with digit position specified)
Only the reading data will be output. The number of digits is not output.



Receive See Output Formats.



Refer to page 227.

An error will occur if reading has not been performed since the menu items were registered.



@SN

Function 1 . . . Obtains the scene number (0 to 9) of the currently displayed scene.

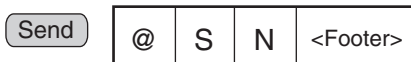

Receive Command executed correctly:

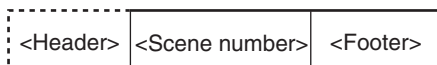

Command not executed correctly:



Function 2 • • • Changes the currently displayed scene.

Send

@	S	N		<Scene number>	<Footer>
---	---	---	--	----------------	----------

▪Set the desired scene number (0 to 9).

Receive Command executed correctly:

<Header>	O	K	<Footer>
----------	---	---	----------

Command not executed correctly:

<Header>	E	R	<Footer>
----------	---	---	----------

@ DC

Function • • • Changes the monitor display status (through/freeze).

Send

@	D	C		<Display code>	<Footer>
---	---	---	--	----------------	----------

▪Set the display code to 0 to specify Through display or 1 to specify Freeze display.

Receive Command executed correctly:

<Header>	O	K	<Footer>
----------	---	---	----------

Command not executed correctly:

<Header>	E	R	<Footer>
----------	---	---	----------

@ MC

Function • • • Changes the mode to **MON** (monitor) mode or **RUN** mode.

Send

@	M	C		<Mode>	<Footer>
---	---	---	--	--------	----------

- Set the mode to 0 to specify **MON** mode or 1 to specify **RUN** mode.

Receive Command executed correctly:

<Header>	O	K	<Footer>
----------	---	---	----------

Command not executed correctly:

<Header>	E	R	<Footer>
----------	---	---	----------

@ MT

Function • • • Reads the most recent read-processing time.

Send

@	M	T	<Footer>
---	---	---	----------

Receive Command executed correctly:

<Header>		<Processing time>	<Footer>
----------	--	-------------------	----------

- The 5-digit processing time (00000 to 99999 ms) is returned if the command was executed correctly.
A value of 99999 will be returned if the actual processing time exceeds 99,999 ms.
A value of 00000 will be returned if the processing time could not be read.
Example: A value of 00230 will be returned when the most recent processing time was 230 ms.

@ SV

Function • • • Saves the system data and all of the scene data to the V530-R160.

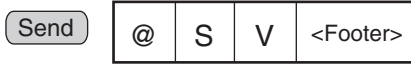

Receive Command executed correctly:

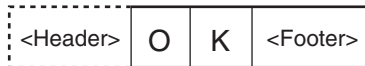

Command not executed correctly:



@ VR

Function • • • Reads the system's version information.



Receive Command executed correctly:

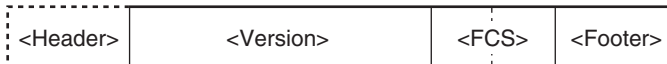

▪Example version information:
V530-R160 Ver1.00 2002/05/30 12:00

@ AL

Function ••• Loads the system and scene data to the V530-R160 from the host.

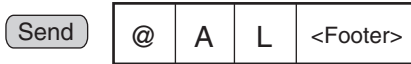

Receive Command executed correctly:

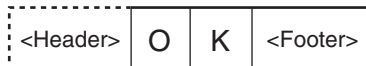

Command not executed correctly:



The data transfer is performed with XMODEM (-CRC or SUM) or ZMODEM protocol.
The XMODEM (-1K) protocol is not supported.

CHECK! The V530-R160 sends the character string "READY" to the host device when the V530-R160 has completed its initialization. Wait for the "READY" string to be received at the host device before starting the data transfer.

@ AS

Function ••• Saves the system and scene data to the host.

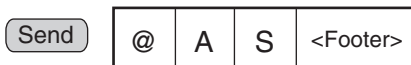

Receive Command executed correctly:



Command not executed correctly:



The XMODEM (-1K) protocol is not supported.

CHECK!

@ BL

Function ••• Loads the image data from the host to the V530-R160.



- For <Memory number>, set a controller memory number in the range 00 to 35.
Example: To load to memory number 3:

BL 03

Receive Command executed correctly:



Command not executed correctly:



CHECK!

The data transfer is performed with XMODEM (-CRC or SUM) or ZMODEM protocol.
The XMODEM (-1K) protocol is not supported.

The V530-R160 sends the character string "READY" to the host device when the V530-R160 has completed its initialization. Wait for the "READY" string to be received at the host device before starting the data transfer.

@ BS

Function ••• Saves the image data from the V530-R160 to the host.



- For <Memory number>, set a controller memory number in the range 00 to 35.
Example: To save memory number 3:

BS 03

Receive Command executed correctly:



Command not executed correctly:



CHECK!

The XMODEM (-1K) protocol is not supported.

@ CL

Function ••• Loads the scene data from the host to the V530-R160.



Receive Command executed correctly:

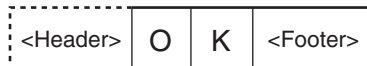

Command not executed correctly:



The data transfer is performed with XMODEM (-CRC or SUM) or ZMODEM protocol.

The XMODEM (-1K) protocol is not supported.

The V530-R160 sends the character string "READY" to the host device when the V530-R160 has completed its initialization. Wait for the "READY" string to be received at the host device before starting the data transfer.

@ CS

Function ••• Saves the scene data from the V530-R160 to the host.

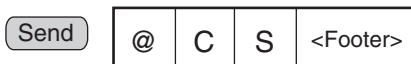

Receive Command executed correctly:



Command not executed correctly:



The XMODEM (-1K) protocol is not supported.

■1:N (Multi Drop) Connection

@ GL

Function ••• The controller with the specified unit number performs one reading. Reading ends when the reading is correctly performed (OK). When the reading is not correctly performed (NG), reading continues to be performed for the number of retries specified in the setting conditions. Controllers with unit numbers other than the specified unit number do nothing.



Receive The data will not be output to the host (serial interface) by simply executing this command. To output the data, send a polling command (@RD). Also, no response will be returned if the menu items are not registered.

@ RD

Function ••• The controller with the specified unit number outputs the latest reading data to the host (serial interface). (Polling command)



Receive Reading OK

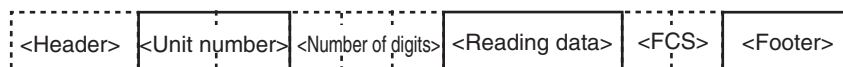

Reading NG



If reading has not been performed since the menu items were registered

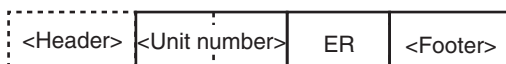

* A setting can be made to add or not add the boxes that are written with dashed lines .

@ MS

Function1 ••• Obtains the scene number (0 to 9) of the currently displayed scene.



Receive Data is output from the controller without a polling command.

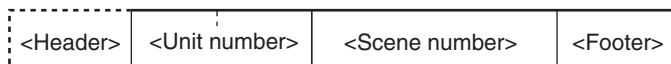

Function 2 ••• Changes the currently displayed scene.

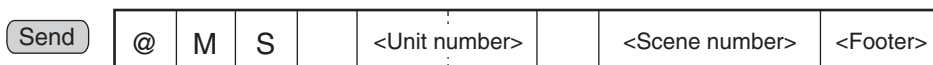

▪Set the desired scene number (0 to 9).

Receive Data is output from the controller without a polling command.
 Command executed correctly:

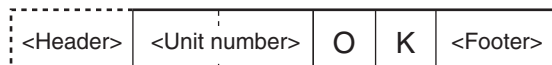

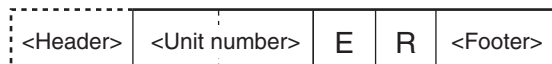

Command not executed correctly:



■ Reading Data Output Format

The following diagrams show the output format used when outputting reading data.
The data items in the dashed lines can be included or omitted from the output format.

- **SYS/Communication/RS-232C/422**  Refer to page 206.
 - Whether or not a header and FCS are appended
 - Which footer is chosen
- **SYS/Communication/Data Output Settings**  Refer to page 210.
 - Select whether or not to use the polling command to control the timing of reading data outputs.
 - Select whether or not to include the number of digits of reading data.

■ 1:1 connection

- When the reading is correctly performed:

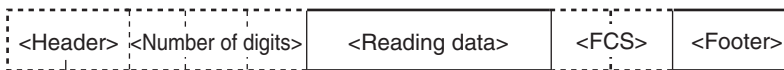

 The data items in the dashed lines can be included or omitted from the output format.

- When the reading is not correctly performed:

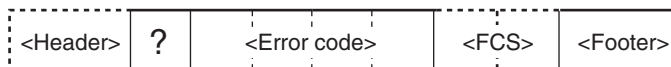

■ 1:N connection (When using with multi drop)

- When the reading is correctly performed:



↑
Unit number of the controller that outputs the reading data

- When the reading is not correctly performed:

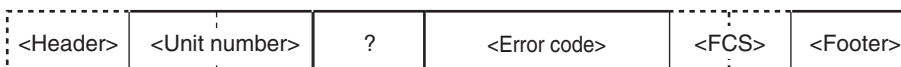

■ **FCS Calculation**

FCS is the result of taking the XOR for each byte between the header and footer (8 bits) and converting to 2-character ASC II code.

The FCS (Frame Check Sequence) can be attached to output data to improve communications. Each time data is received, the host link calculates the FCS and checks it against the FCS attached to the sent data so that the sent data can be checked for errors.

For details on an FCS check program, see *SECTION 10 Appendix FCS Check Program Example (BASIC)*.



Refer to page 278 (SEC.10).



An FCS can only be appended if the communications mode is **Normal**.

CHECK!



Refer to page 206.

Example: Reading data: ABCDEFG

The details of the reading data and calculation method are as follows.

• Reading data



• Calculation

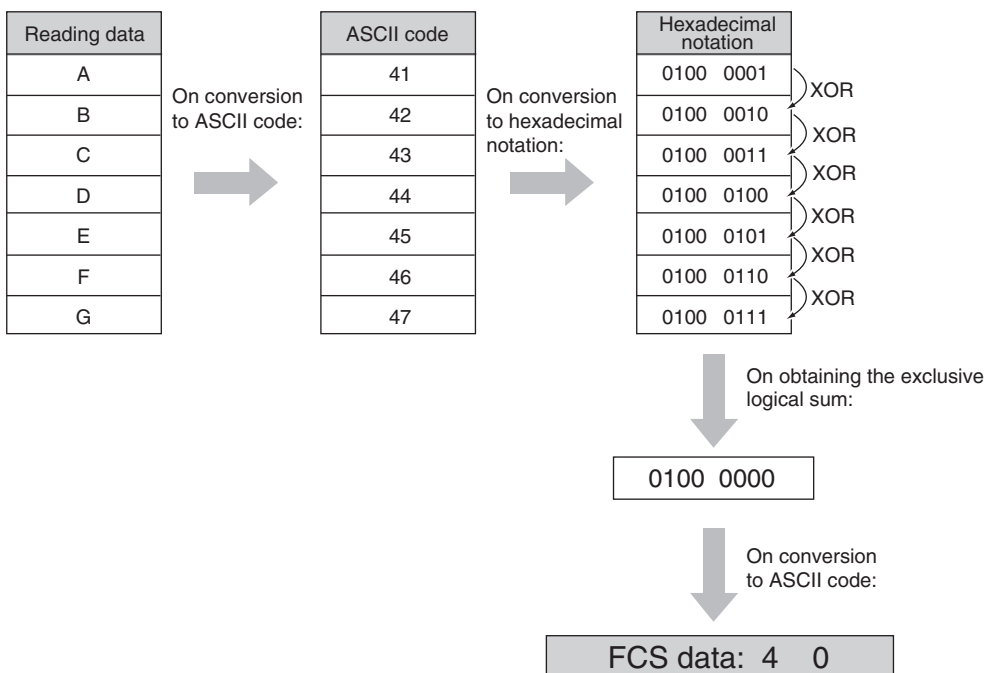

Connection Examples for Programmable Controller (Normal)

This is a connection example using the CQM1H programmable controller made by OMRON.
The flow is such that a read command [@GL] is input from the programmable controller to the controller, then the controller outputs the judgement result to the programmable controller.

System Configuration

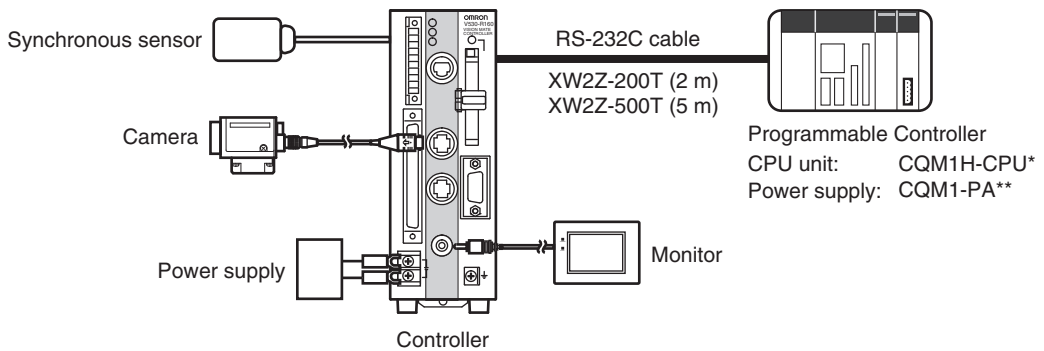

RS-232C Cable Wiring (XW2Z-200T/XW2Z-500T)

The maximum cable length is 15 m.

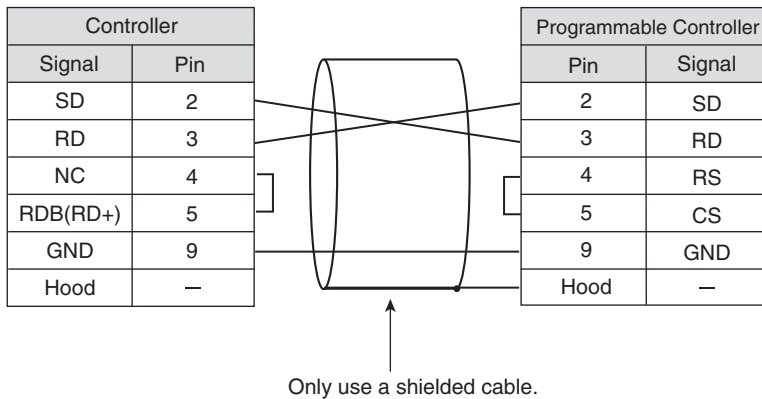

■ **Settings at the Programmable Controller**

- Turn OFF DIP switch 5 of CQM1H.
- Set the communications conditions.

Set DM6645 to **1001**, DM6646 to **0904**, DM6648 to **1000** and DM6649 to **0D00**.

Refer to the operation manual for CQM1H for the ways to change the setting.

- Set the read command.

Set DM0100 to **4047** and DM0100 to **4C00**.

Item	Setting
Communications method	Normal
Baud rate	9600 bps
Data length	7 bit
Parity bits	EVEN
Stop bits	2 bit
Header	None
Footer	CR

■ **Settings at the Controller**

Make the following communication settings.

Item	Setting
Baud rate	The same settings as those of the Programmable Controller.
Data length	
Parity bits	
Stop bits	
Header	
Footer	
FCS	OFF
Mode	Normal

■ Program Examples

This is a program in which a read command is sent from the programmable controller (model CQM1H) and the data read by the controller is received by the CQM1H.

1. Set the reading conditions of the V530-R160 and set the reading mode to **RUN** mode.
2. Send the read command from the programmable controller.

▼
The controller performs reading.
The data received at the CQM1H is saved starting from DM0200.

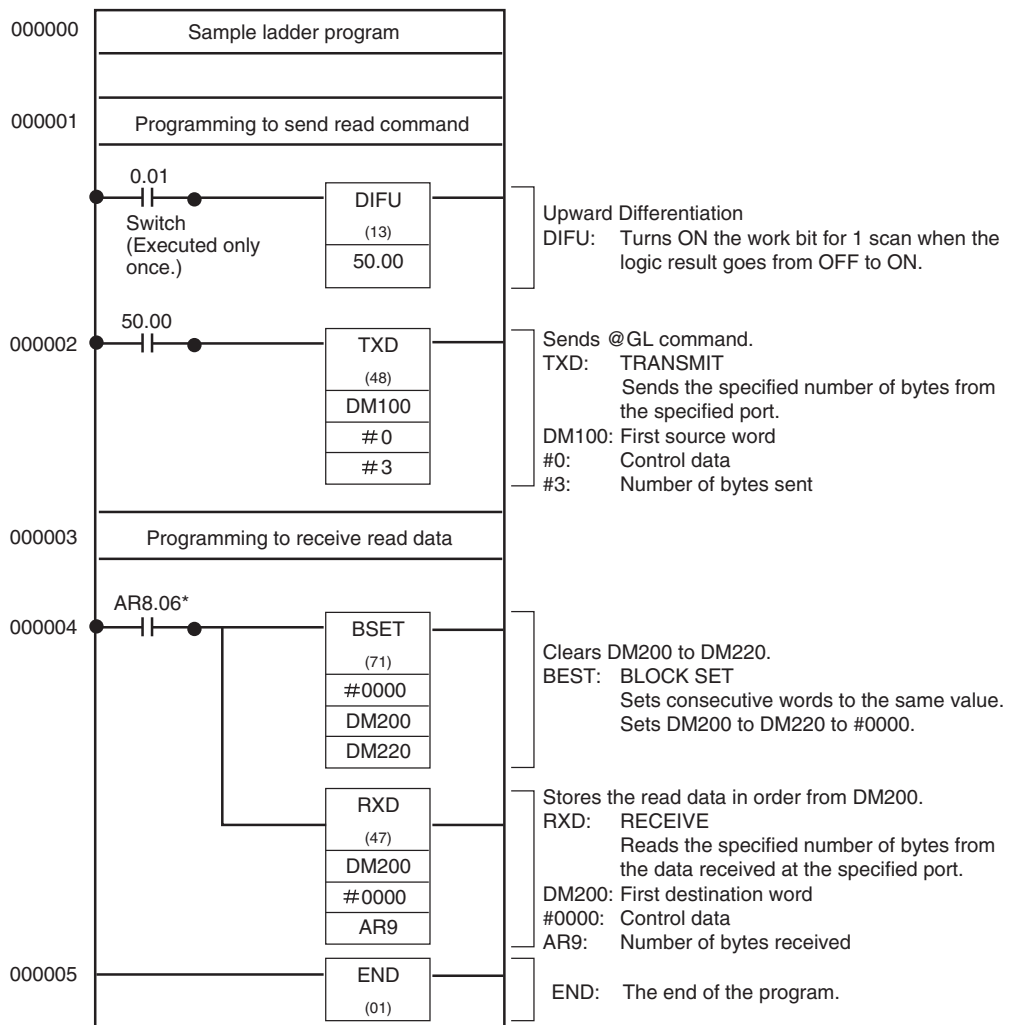

*AR8.06: RS-232C port reception completed flag

Serial Interface (Host Link)

Communicates with a host such as a programmable controller via a serial interface in the host link format. There is no need to set a communications program at the programmable controller side. Set **Host link** for **Mode** at **SYS/Communication/RS-232C/422**.



Refer to page 236.



Only a 1:1 connection can be used with the host link mode. 1:N connections are not supported.

CHECK!

- **SET** mode

Command input is not accepted.

- **MON** mode

Command input is accepted, but reading results are not output to the serial interface. They are just confirmed on the monitor.

- **RUN** mode

Possible to input commands and output the reading results.



When the host link mode is used, if the power to the programmable controller is turned OFF, the setting for **Mode** at **SYS/Communication/RS-232C/422** is automatically set to **Normal**.

CHECK!

If there is a problem using this serial interface specification, communicate using the no-protocol format.

Flow Charts

■ When the Serial Interface is used for both Input and Output

Commands for the V530-R160 are written to the Read Area in the programmable controller. The V530-R160 automatically reads these commands and executes them.

Reading results are written to the programmable controller.

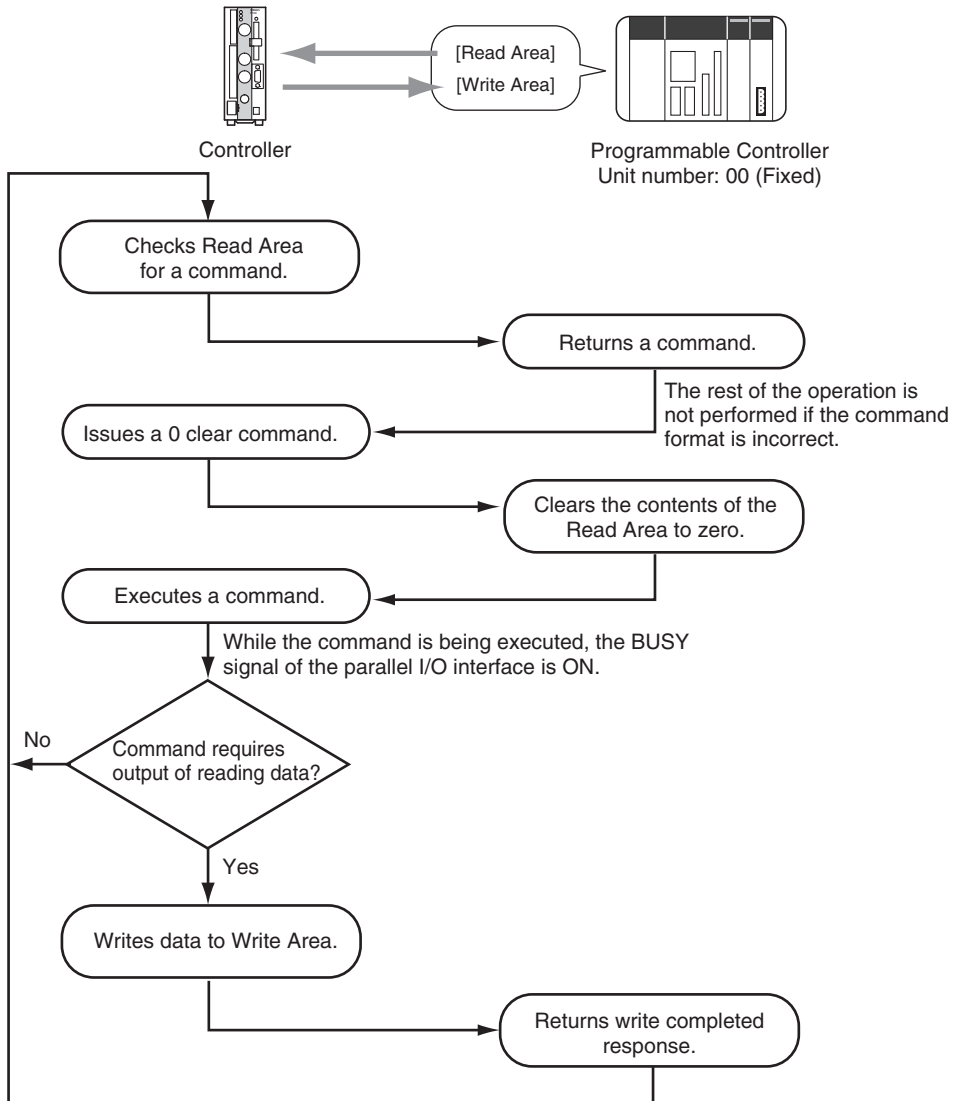

A timeout error occurs if there is no response within 5 seconds and it is assumed that the line is broken or the programmable controller is not working correctly. An error message is displayed on the screen and the ERR signal of the parallel I/O interface is turned ON.



If there is a problem using this serial interface specification, communicate using the no-protocol format.

CHECK!

■ **TRIG A Signal as Reading Trigger**

The trigger is used to cause the V530-R160 to read data and the data is written to the programmable controller.

Set the **Read Area** to **None**.

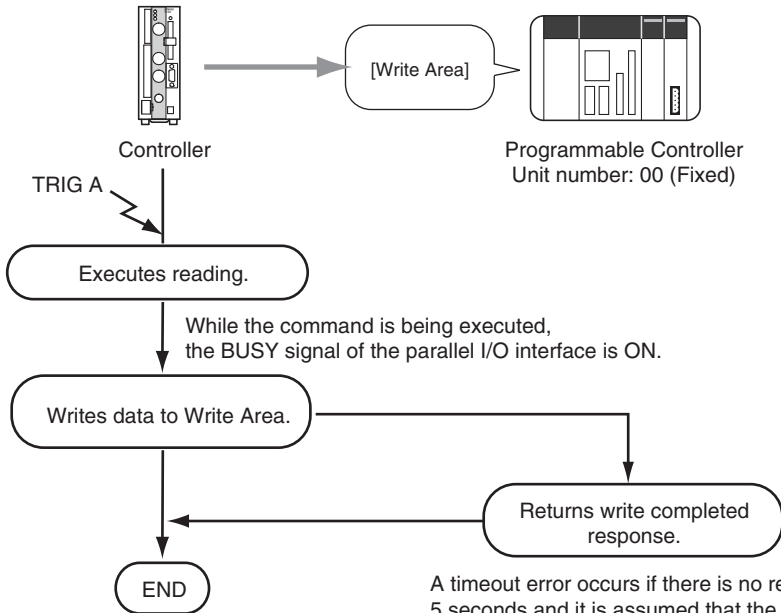

A timeout error occurs if there is no response within 5 seconds and it is assumed that the line is broken or the programmable controller is not working correctly. An error message is displayed on the screen and the ERR signal of the parallel I/O interface is turned ON.

NOTICE

Time the input of TRIG A considering the image processing time and data output time, allowing sufficient leeway. An error will occur if the next input occurs before communications have been completed.

■ Using TXD Instructions

This is a method in which commands are not set in the Read Area but are actively sent from the programmable controller to the controller.

Set the **Read Area** to **None**.

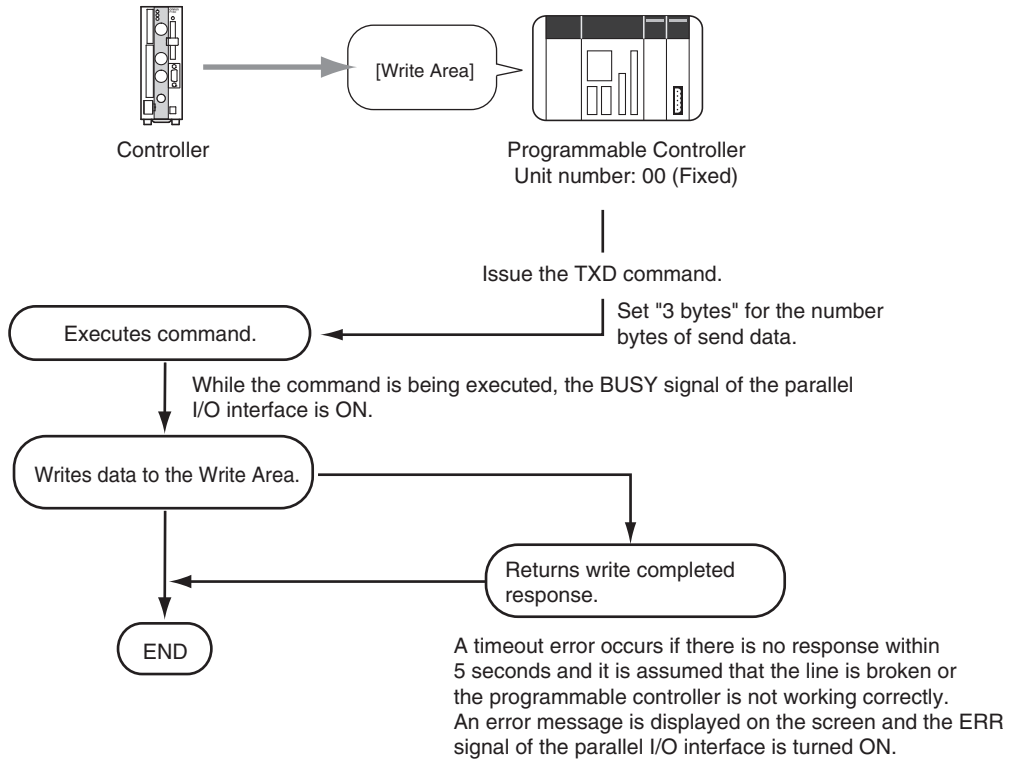

Setting Communications Specifications

■ Setting the Communication Speed and Communication Mode

The methods for setting the communication speed and data length are explained here. The same communication settings must be used on both the V530-R160 and the host device.

1. Move the cursor to **MON** or **RUN** and press the **ENT** Key.
2. Select **SYS**.

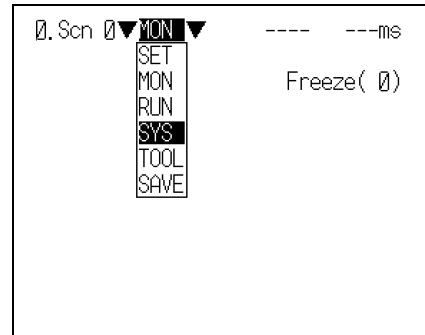

▼
The System settings screen will be displayed.

3. Select **Communication**.

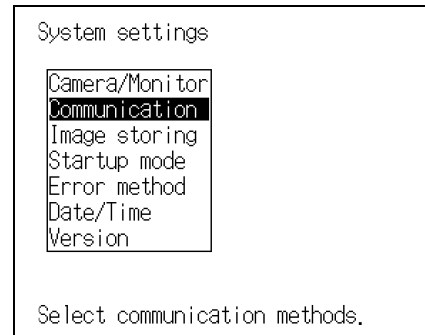

▼
The selections will be displayed.

4. Select **RS-232C/422**.

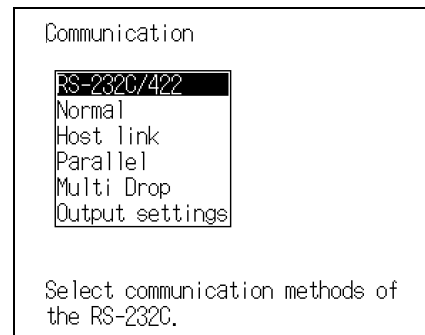

The screen for setting the communications specifications will be displayed.

- 5.** Make the settings for each item.
- 6.** Select **End**.

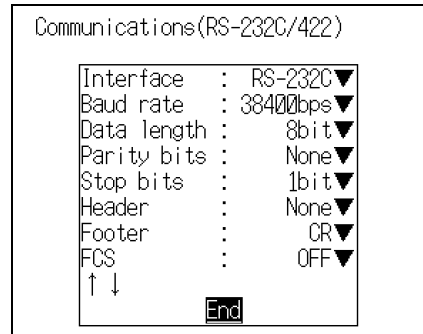

The setting will be registered and the screen in **4.** will return.

Set Items and their details

Item	Selection	
Interface	RS-232C*, RS-422	
Baud rate (See note 1.)	2400, 4800, 9600, 19200, 38400*, 57600, 115200 (bps)	The same settings as those of the Programmable Controller
Data length	7, 8* (bit)	
Parity bits	None*, Odd, Even	
Stop bits	1*, 2 (bit)	
Header	None*, STX, ESC	
Footer	CR*, LF, CR+LF, ETX	
FCS	OFF*, ON	
Mode	Select Host Link . (Normal*, Host link)	
Protocol (See note 2.)	XMODEM*, ZMODEM	

The asterisk (*) indicates the default setting.

Note 1: Since communications speeds higher than 20 kbps are not defined with the RS-232C standard, depending on the cable length, if **38400** bps or a higher setting is selected it may not be possible to perform communications properly.
If this happens, change the setting to **19200** bps or lower.

Note 2: The XMODEM (-1K) protocol is not supported.

■ Settings Relating to Programmable Controllers

Set the Read Area where the controller checks the command, and the Write Area where the reading result is output.

1. Select **Host link** on the communications specifications setting screen.

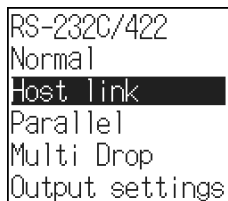

```
RS-232C/422
Normal
Host link
Parallel
Multi Drop
Output settings
```

▼
The Host link setting screen will be displayed.

2. Make the settings for each item.
3. Select **End**.

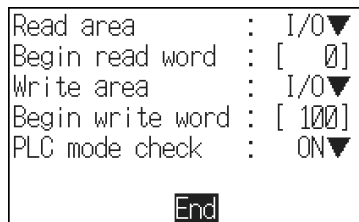

```
Read area      : I/O▼
Begin read word : [ 0 ]
Write area     : I/O▼
Begin write word : [ 100 ]
PLC mode check : ON▼

End
```

▼
The setting will be registered and the screen in **1.** will return.

Set Items and their details

Item	Selection	
Read area	Select the relay where the controller checks commands. I/O*, HR (holding relay), LR (link relay), DM (data memory), None (No reading. TXD instruction will be accepted.)	
Begin read word	Set the first word to read in area specified above. (0 to 9995; default setting: 0)	
Write area	Select the relay where the controller outputs execution results. I/O*, HR (holding relay), LR (link relay), DM (data memory), None (No writing)	
Begin write word	Set the first word to write in the area specified. (0 to 9996; default setting: 100)	
PLC mode check	ON*	On entering the MON mode or RUN mode, the mode of the programmable controller is checked. Reading does not start unless the programmable controller is in MON mode. (Error messages are displayed.)
	OFF	When the V530-R160 is in MON or RUN mode, it sends a mode change command to the Programmable Controller to forcibly switch the Programmable Controller to MON mode.

The asterisk (*) indicates the default setting.

I/O Format

■ Input Format

The following commands can be input from the host to the controller.
Set the command to be executed in the Read Area.

■ Command list

Command code	Function	Page
0010	Performs one reading.	p.241
0011	Starts continuous reading.	p.241
0012	Stops continuous reading.	p.241
0020	Switches to the specified scene number.	p.242
0021	Increases the scene number for the scene to be displayed by one.	p.242
0022	Decreases the scene number for the scene to be displayed by one.	p.242
0023	Obtains the scene number of the currently displayed scene.	p.242

▪ **Format**

The format is explained here in command code order. The commands are input in BCD code. Set the command in the reading word of the Read Area.

0010: One shot reading

Function ••• Performs one reading.

Reading ends when the reading is correctly performed (OK).

When the reading is not correctly performed (NG), reading continues to be performed for the number of retries specified in the setting conditions.

The reading result is output to the Write Area.



Refer to page 243.

Reading start word	Data				Description
+0	0	0	1	0	Command code

0011: Continuous reading

Function ••• Performs continuous reading.

The reading result is output to the Write Area.



Refer to page 243.

Reading start word	Data				Description
+0	0	0	1	1	Command code

0012: Continuous reading stop

Function ••• Stops continuous reading.

Reading start word	Data				Description
+0	0	0	1	2	Command code

0020: Displayed scene selection

Function ••• Switches the scene in response to a designated scene number.

Reading start word	Data				Description
+0	0	0	2	0	Command code
+1	0	0	0	Scene number	Scene number (0 to 9)

0021: Displayed scene number +1

Function ••• Increases the scene number for the screen to be displayed by one.

When the current scene number is 9, the scene number will switch to 0.

Reading start word	Data				Description
+0	0	0	2	1	Command code

0022: Displayed scene number -1

Function ••• Decreases the scene number for the scene to be displayed by one.

When the current scene number is 0, the scene number will switch to 9.

Reading start word	Data				Description
+0	0	0	2	2	Command code

0023: Obtain displayed scene number

Function ••• Obtains the scene number of the currently displayed scene.

Reading start word	Data				Description
+0	0	0	2	3	Command code

Writing start word	Data				Description
+0	Write flag	0	0	0	Write flag
+1	0	0	0	Scene number	Scene number (0 to 9)



Write flag switches between [0] ← → [F] each time data is output.
 Monitor the flag to confirm whether reading judgement has been written.

CHECK!

■ Output Format

On execution of reading, the reading data is saved in the Write Area of the programmable controller in ASCII code.

Write flag switches between [0] ↔ [F] each time data is output. Monitoring changes in the status of this bit makes it possible to determine whether data has been written. Since the bit status becomes "0" after the final measurement, save "F" as the initial value.

Writing start word	Data			Description	
+0	Write flag	0	0	0	Write flag
+1	Reading data		Reading data 2nd byte		Reading data
+2	Reading data 3rd byte		Reading data 4th byte		
.	.	.			
.	.	.			
.	.	.			
+27	Reading data 53rd byte		Reading data 54th byte		
+28	Reading data 55th byte		Reading data 56th byte		

- In the host link mode, there are restrictions on the volume of communications data that can be sent at one time.

The maximum volume of data is as follows. The reading data after the 56th letter are ignored.

- Letters of the alphabet: 56 letters
- When reading is NG, error codes are output to word +1.
- If the reading data consists of an odd number of bytes, a space (ASCII code 20) is inserted.

For error code details, refer to *Error Messages and Corresponding Corrective Actions* in *Section 9, Troubleshooting*.



Refer to page 257.

Connection Examples for Programmable Controller (Host Link)

This is an example of connection when using a CS1H programmable controller made by OMRON.

System Configuration

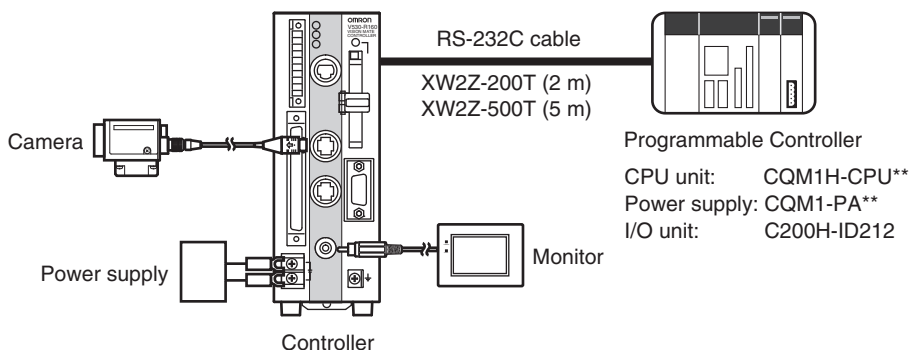

RS-232C Cable Wiring (XW2Z-200T/XW2Z-500T)

The maximum cable length is 15 m.

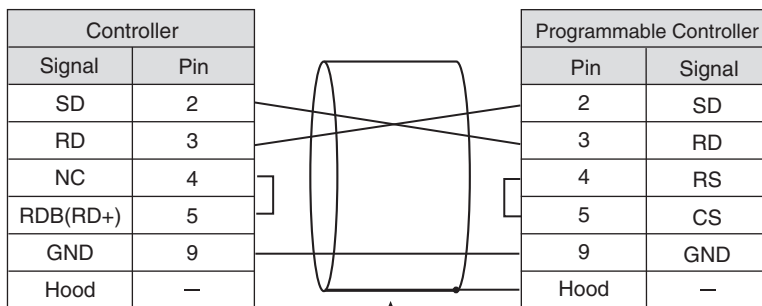

Only use a shielded cable.



■ Settings at the Programmable Controller

Set the communications conditions of the host link unit of the programmable controller or the host link port built into the CPU unit.

For details on how to make the settings, refer to the manual for the programmable controller.

Item	Setting
Communication method	Host link
Unit number	00
Baud rate	9600 bps
Data length	7 bit
Parity bits	EVEN
Stop bits	2 bit

■ Settings at the Controller

Item		Setting
Communications specifications  Refer to page 236.	Baud rate	The same settings as those of the Programmable Controller.
	Data length	
	Parity bits	
	Stop bits	
	Mode	
Host link  Refer to page 236.	Read area	DM
	Begin read word	0100
	Write area	DM
	Begin write word	0110

■ **Program Examples**

This program inputs a One Shot Reading Command to the Programmable Controller's DM. The V530-R160 references this command and reads the data. The reading data is written to the specified words in the Programmable Controller.

- 1.** Set the reading conditions of the V530-R160 and set the reading mode to **RUN** mode.
 - 2.** Set the Start Reading Command in **DM0100** of the Programmable Controller.
-

▼
The V530-R160 reads codes, sets the Write Flags in DM0110, and writes the reading data to DM words beginning with DM 0111.

- 3.** Check the write flag DM0110 at the Programmable Controller.
Check whether or not data has been written.
-

▼
If data has been written, the write flag changes from [0] ← → [F].

■ Ladder Program Example

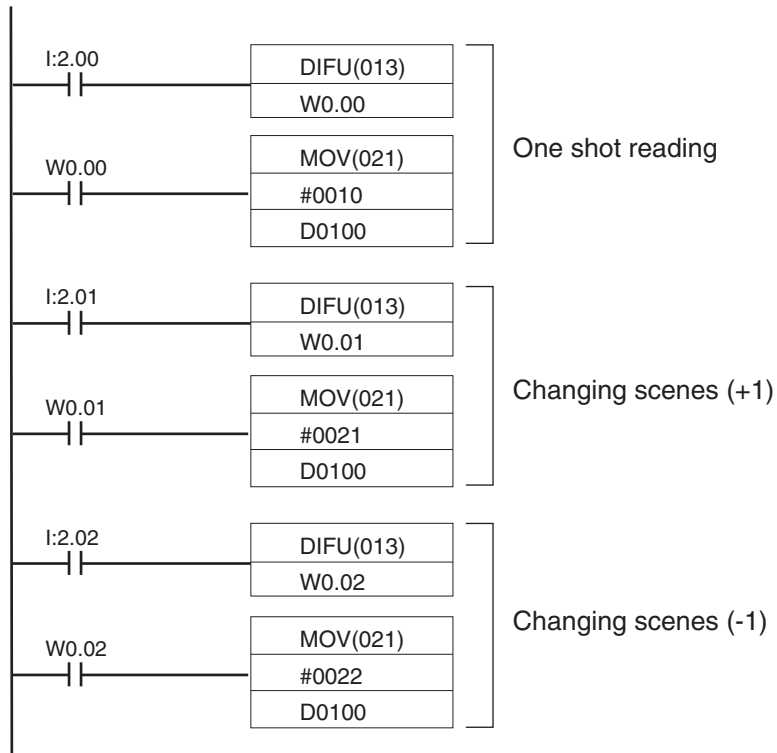

• Example of ladder program error

If a ladder like the one shown below has been set with the Read Area of the controller set to I/O, bit-unit output settings are not possible.

Settings at the controller

Item	Setting
Read area	I/O
Begin read word	0100
Write area	DM
Begin write word	0110

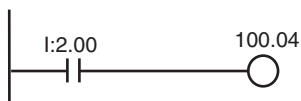





The read command "0010" will remain set in the Read Area and reading will be executed continuously.

MEMO

SECTION 9

Troubleshooting



This section explains the countermeasures to take when reading cannot be executed correctly, or when trouble occurs.

 Improving Reading	250
 Error Codes and Countermeasures	253
 Error Messages and Corresponding Corrective Actions	257
 Troubleshooting	261

Improving Reading





Environment and Setup

Items	Details
Image	<p>Adjust the lighting and the focus to produce a suitable image. The image can be checked in real time by switching to a through image.</p> <p> Refer to page 76 (Sec.4).</p>
Lighting	<p>Use appropriate lighting for the application and the read object. The reading accuracy can be improved significantly by changing the lighting.</p> <p> Refer to page 49 (Sec.2).</p>
Field of vision	<ul style="list-style-type: none"> • If the code image is too large, and not all of it can be read, resulting in an NG reading (because of hollowing of dots), increase the field of vision. The effects of hollowing can be prevented. • If the cell recognition coordinates are incorrect, decrease the field of vision and thereby make the code image larger. Cell recognition accuracy can be improved. • Adjust the field of vision for the code to be at least 5 pixels per cell. Under normal conditions, it is recommended that settings are made so that the number of pixels per cell is between 7 and 12. <p>Check the number of pixels on the pattern registration screen.</p> <p> Refer to pages 83 (Sec.4) and 132 (Sec.5).</p> <ul style="list-style-type: none"> • Try changing the lens configuration and the field of vision.
Margins	<p>A margin of at least a cell must be provided around the code.</p>

Conditions Settings

Confirm the following settings.





Items	Possible problem
Menus	[Check Items] Is the correct menu selected?
	[Countermeasure] Choose the menu item appropriate for the code to be read.  Refer to page 76 (Sec.4).
Reading	[Check Items] • Has a finder pattern been detected? • Has cell recognition been performed properly? If ON is set for Display settings/FP & Cell position the finder pattern and cell recognition position can be checked on the monitor.  Refer to page 114 (Sec.5).
	[Countermeasure] Reading accuracy can be improved by adjusting the following items: • Field of vision • Lighting • Activation of Smoothing in Filtering • Activation of BGS levels
Settings	[Check Items] Check that the following items match the code being read: • Symbol color • R&L reverse • Matrix size (for DataMatrix mode) • Version (for QRCode mode)
	[Countermeasure] Match the settings on the left to the reading code.
Other	[Check Items] Check error codes.
	[Countermeasure] Take countermeasures according to the error codes listed on page 253.  Refer to page 253.

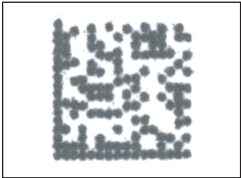

To read at high speed, set a small search area and angle range. Note that correct reading may not be possible in some cases, so you must verify by actually performing reading after the change.

Countermeasure Examples

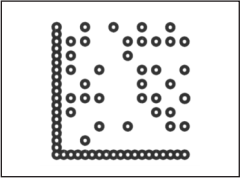
The following are only a selection of examples of possible countermeasures. Reading operation will not necessarily be improved by performing the following operations and so execute a reading to confirm correct operation.

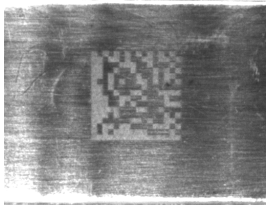
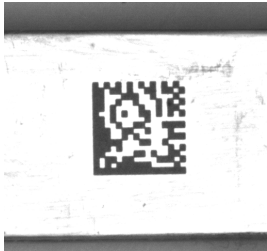
Items	Possible problem
<p>Dot code Hollowing of dots</p>	<ul style="list-style-type: none"> • The influence of hollowing can be decreased by increasing the field of vision and thereby decreasing the size of the code image. • The influence of dots can be reduced by activating the Dilate or Erosion function of 0. Image Adjust/Filtering. • The influence of dots can be further reduced using the smoothing function (0. Image Adjust/Filtering retry). The influence of hollowing can be decreased by adjusting the BGS levels (0. Image Adjust/BGS levels). <p> Refer to page 94 (Sec.5).</p> <div style="display: flex; justify-content: space-around; align-items: center;"> <div style="text-align: center;">  Before countermeasure </div> <div style="font-size: 2em;">→</div> <div style="text-align: center;">  After countermeasure </div> </div> <div style="display: flex; justify-content: space-around; align-items: center; margin-top: 20px;"> <div style="text-align: center;">  Before countermeasure </div> <div style="font-size: 2em;">→</div> <div style="text-align: center;">  After countermeasure </div> </div>
<p>Lighting</p>	<p>Improve reading accuracy by using the optimum lighting for the reading object. Example: Try the following countermeasure when performing reading for a code created by direct marking with a laser on stainless steel.</p> <div style="display: flex; justify-content: space-around; align-items: center;"> <div style="text-align: center;">  Before countermeasure (Oblique Lighting) </div> <div style="font-size: 2em;">→</div> <div style="text-align: center;">  After countermeasure (Coaxial Lighting) </div> </div>

Error Codes and Countermeasures

The error codes that are generated in the event of a reading NG, and their countermeasures, are listed here in error code order.

■ DataMatrix Reading

Error code	Description	Countermeasures	
E100	No Finder Pattern	No finder patterns were detected. • Check if any pattern is registered. A finder pattern may not be registered.	p.81
E110	Finder Pattern Over	Multiple candidate points have been detected for the finder pattern. • Increase the correlation value. • Check the printing of the reading code. • The position of finder patterns can be confirmed on the monitor when Display settings/FP & Cell position is turned ON. • Register the pattern again. The registered pattern may not be the optimum one.	p.108 p.114
E120	Decode Error (Timing pattern detection error)	Codes were restored to correct errors, but not decoded correctly. The timing patterns in the X or Y directions may be stained or damaged. • Check the condition of the timing pattern. • Check the matrix size setting. The size may not be set correctly. • Register the pattern again. The registered pattern may not be the optimum one.	p.254 p.110
E121	Decode Error (Timing pattern detection error in X direction)	No timing pattern in the X direction could be detected, and correct decoding was not possible. The timing pattern in the X direction may be stained or damaged. • Check the condition of the timing pattern.	p.254
E122	Decode Error (Timing pattern detection error in Y direction)	No timing pattern in the Y direction could be detected, and correct decoding was not possible. The timing pattern in the Y direction may be stained or damaged. • Check the condition of the timing pattern.	p.254
E123	Decode Error (Cell recognition error)	Codes were restored to correct errors, but not decoded correctly. Data of DataMatrix may be stained or damaged. • Check the condition of the data part of the code. • Register the pattern again. The registered pattern may not be the optimum one. • Increase the size of the code image. The cell recognition coordinates may be incorrect.	p.254

Error code	Description	Countermeasures	
E150	Decode Error (No definition error)	The printing is in a special format and not defined for the V530-R160. • Change the printing format.	–
E200	Timeout Error	Decoding was not performed within the timeout time. • Make the reading angle in Pattern settings/Code settings smaller. • Lengthen the Reading settings/Timeout . • Change the angle of vision, e.g. by increasing the size of the code image.	p.108 p.112

▪ DataMatrix explanatory diagram

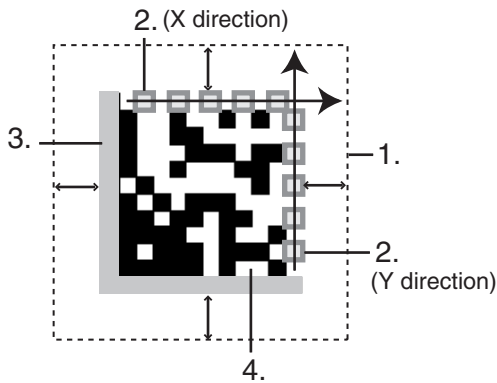

1. A margin of 1 or more cells around the code is required.
2. Timing patterns (The cross point between black and white.)
3. The L-shape in the corner is a finder pattern.
4. An area other than 1 to 3 contains the data.

■ QRCode Reading

Error code	Description	Countermeasures	
E000	No Finder Pattern	No finder patterns were detected. • Check if a pattern is registered. A finder pattern may not be registered.	p.130
E004	Missing Finder Pattern	One or more points of a finder pattern have been detected, but there are insufficient points for detection. Or, three points have been detected but their relative positioning is incorrect. Some of the finder patterns may be stained or damaged. • Check the printing of the reading code. • The position of finder patterns can be confirmed on the monitor when Display settings/FP & Cell position is turned ON. • Register the pattern again. The registered pattern may not be the optimum one.	p.114
E005	Finder Pattern Over	Multiple finder patterns have been detected. • Increase the correlation value. • Check the printing of the reading code. • The position of finder patterns can be confirmed on the monitor when Display settings/FP & Cell position is turned ON. • Register the pattern again. The registered pattern may not be the optimum one.	p.137 p.114
E011	Decode Error (Format information error)	No “format information” could be detected in the QRCode. Format information in QRCode may be stained or damaged. • Check the “format information” part of the code.	p.256
E012	Decode Error (Version information error)	No “version information” could be detected in the QRCode. Version information in QRCode may be stained or damaged. • Check the “version information” part of the code.	p.256

Error code	Description	Countermeasures	
E013	Decode Error (Cell recognition error)	Codes were restored to correct errors, but not decoded correctly. Data of QRCode may be stained or damaged. <ul style="list-style-type: none"> • Check the condition of the data part of the code. • Register the pattern again. The registered pattern may not be the optimum one. • Increase the size of the code image. The cell recognition coordinates may be incorrect. 	p.256
E020	Decode Error (No definition error)	The printing is in a special format and not defined for the V530-R160. (e.g. link mode) <ul style="list-style-type: none"> • Change the printing format. 	–
E200	Timeout Error	Decoding was not performed within the timeout time. <ul style="list-style-type: none"> • Make the reading angle in Pattern settings/Code settings smaller. • Lengthen the Reading settings/Timeout. • Change the angle of vision, e.g. by increasing the size of the code image. 	p.137 p.112

▪ QRCode explanatory diagram

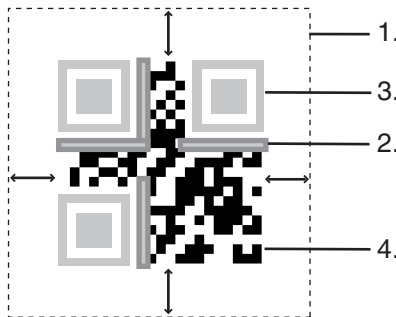











1. A margin of 1 or more cells around the code is required.
2. Format information of the code. (four  locations)
3. Finder patterns (Symbols in three corners)
4. An area other than 1. to 3. contains the data.

Error Messages and Corresponding Corrective Actions



The error messages displayed on the screen and the corresponding corrective actions are presented.

 **ERR** When a message with this symbol appended is displayed, the ERR signal of the parallel I/O interface is ON.







Error message	Countermeasures	
The PLC is not in the Monitor mode.	Change the mode of the Programmable Controller to MON mode.	–
Intelligent Lighting is not selected.	Check the setting for SYS/Camera/Monitor . (Reason) It is possible that the setting for SYS/Camera/Monitor/Intelli. Light. 0 or Intelli. Light. 1 is Not used .	p.181
Camera connection is incorrect.  ERR	<ul style="list-style-type: none"> • Are the Camera Cables connected to the V530-R160? • Is the Camera Cable disconnected from the Camera? • Check the setting for SYS/Camera/Monitor, then turn the power OFF and back ON. 	p.181
Cannot access this file.	Check the following points and re-select the file. <ul style="list-style-type: none"> • Is the file read-only? • Is Japanese used in the file name? • Does the Memory Card have sufficient space to save the file? 	–
Host link error. Changing for normal mode.  ERR	Check the following points then restart the controller and carry out communications. Or change the setting for Mode in SYS/Communication/RS-232C/422 to Host link (*) and then carry out communications. <ul style="list-style-type: none"> • Is the cable connected properly? • Are the communications specifications for the host device and the V530-R160 the same? • Is the Programmable Controller ON? * The communications Mode will automatically return to Normal mode when this error occurs.	p.236

Error message	Countermeasures	
Communications error  ERR*	Turn OFF the power to the V530-R160, and check for the following items before restarting the V530-R160. <ul style="list-style-type: none"> • Is the cable connected properly? • Are the communications specifications for the host device and the V530-R160 the same? • Is the host device operating properly? (Reason) Data transfer has been interrupted due to a communications error in communications between the V530-R160 and a host device. If the same error message appears after restart, it may mean that the V530-R160 is faulty. Contact your OMRON representative.	p.192 p.206 p.236
Communications error  ERR		
Communications error  ERR		
Timeout error  ERR		
Timeout error  ERR		
Timeout error  ERR		
Incorrect data format received.  ERR	Select the correct transfer file and re-execute the data transfer. (Reason) The wrong file has been selected.	–
Data are too large. Cannot save by serial communication.	Save the data to a Memory Card or delete surplus data and then save. (Reason) Data 2MB or greater cannot be saved using serial communications.	–

* : The ERR signal only turns ON when an error occurs in the **MON** mode or **RUN** mode.

Error message	Countermeasures	
Cannot delete directory having files.	Delete the files in the directory to be deleted or move the files to another directory. (Reason) Only empty directories can be deleted.	p.171
Directory name is not specified.	Specify the directory name and press the ENT Key.	
Directory name contains unusable character.	Check the directory name. The following characters cannot be used: ¥ / , ; * ? " < > & .	–
Same directory name has already existed.	Specify a directory name that is not being used.	–
Same file name has already existed.	Specify a file name that is not being used.	–
Date/time settings error.	Set the correct data and time. (Reason) A date not in the calendar or an invalid time has been input.	p.188
File name is not specified.	Specify the file name and then press the ENT Key.	–
File name contains unusable character.	Check the directory name. The following characters cannot be used: ¥ / , ; * ? " < > & .	–
Memory card access error  ERR*	<ul style="list-style-type: none"> • The recommended Memory Card has not been inserted. • Use another Memory Card. • The Memory Card has not been formatted. 	p.51
Memory card is not inserted  ERR*	Insert the recommended Memory Card.	p.51

* : The ERR signal only turns ON when an error occurs in the **MON** mode or the **RUN** mode.

Error message	Countermeasures	
Insufficient free space of memory card. 	<ul style="list-style-type: none"> • Delete unnecessary files to create free space. • Replace the Memory Card with a bigger capacity card. 	-
Insufficient flash memory. 	<ul style="list-style-type: none"> • Delete unnecessary scenes. 	-
Insufficient model memory. 	<ul style="list-style-type: none"> • Reduce the size of the registered patterns. • Delete unnecessary patterns. 	-
Insufficient work memory. 	<ul style="list-style-type: none"> • Delete unnecessary scenes. 	-
Loaded file error. 	Specify the correct file and reload. (Reason) <ul style="list-style-type: none"> • A formatting error may have occurred during data or program file load. • Data 2MB or greater cannot be loaded using serial communications. Load the data using the Memory Card. 	-

* : The ERR signal only turns ON when an error occurs in the **MON** mode or the **RUN** mode.

Troubleshooting



Connection Errors

Symptoms	Causes and remedies	
The POWER indicator is not lit.	<ul style="list-style-type: none"> The power supply is not connected properly. The power supply voltage is below the allowed range (20.4 to 26.4 VDC). 	p.45
The Video Monitor is blank.	<ul style="list-style-type: none"> The power to the Video Monitor is not ON. The monitor cable is not connected properly. The Video Monitor is malfunctioning. (When the LCD monitor is used) The power supply is not sufficient for the LCD monitor. 	p.43
The Video Monitor image is not clear.	<ul style="list-style-type: none"> There is electrical noise entering from the power supply or cables. The Monitor Cable is not connected properly. 	–
Cannot make key inputs on the Console.	<ul style="list-style-type: none"> The Console Cable is not correctly connected. 	p.43
Camera images are not displayed. (when using a Camera with a light)	<ul style="list-style-type: none"> The camera cable is not properly connected. The Light Cable is not properly connected. 	p.43
Camera images are not displayed. (when using a standard CCTV lens and light.)	<ul style="list-style-type: none"> The lens cap has not been removed. The Camera Cable is not properly connected. The lens diaphragm is opened or closed too far. The shutter speed is not suitable. The light method is not suitable. 	p.43 p.93 p.49
The images on the monitor are recognized but codes are hard to read.	<ul style="list-style-type: none"> Refer to the entry for the error code in <i>Error Codes and Countermeasures</i>. Change the setting conditions and adjust the camera and lighting. 	p.253



Errors During Menu Operation

Symptoms	Causes and remedies	
The reading data is not displayed on the monitor.	<ul style="list-style-type: none"> The V530-R160 is not in MON or RUN mode. 	p.87



Parallel I/O

Symptoms	Causes and remedies	
Trigger signals (input signals) are not received.	<ul style="list-style-type: none"> The cables are not correctly wired. The signal line is disconnected. The V530-R160 is not in MON or RUN mode. 	p.56 p.176 -
Signals cannot be output to the host.	<ul style="list-style-type: none"> The trigger signal has not been input. The signal line is disconnected. The cables are not correctly wired. The V530-R160 is not in RUN mode. 	p.87 p.176 p.56 -



Serial interface

Symptoms	Causes and remedies	
No communications are possible.	<ul style="list-style-type: none"> The cables are not correctly wired. The communications specifications of the V530-R160 do not match those of the host device. The communications mode was not selected under SYS/Communication/RS-232C/422. Select either Normal or Host link for Mode under RS-232C/422 depending on the purpose. The V530-R160 is not in MON or RUN mode. 	p.60 p.206 p.236 -
The Unit operates well initially, but after a while there is no response from the V530-R160.	<ul style="list-style-type: none"> The reception buffer on the external device (e.g. computer) is full. Check that settings allow the data to be properly received. 	-

SECTION 10

Appendix

☒ Maintenance	264
Maintaining and Changing a Camera with a Light	264
Replacing the Battery	266
Regular Inspections	267
☒ Specifications and Dimensions	268
☒ ASCII Codes	277
☒ FCS Check Program Examples (BASIC)	278
☒ Data Capacity Tables	279
☒ Glossary	283

Maintenance

Maintaining and Changing a Camera with a Light

- The Light will gradually become dimmer as it is used (approx. 20% dimmer after 1,500 hours of operation).
- Replace the Light after approx. 1,500 hours of use.
- Replace the Light if it is partially damaged or not fully functioning.

■ F150-SLC20 Maintenance

	Field of vision	Model
Light	20 mm	F150-LTC20

▪ Removing the Light

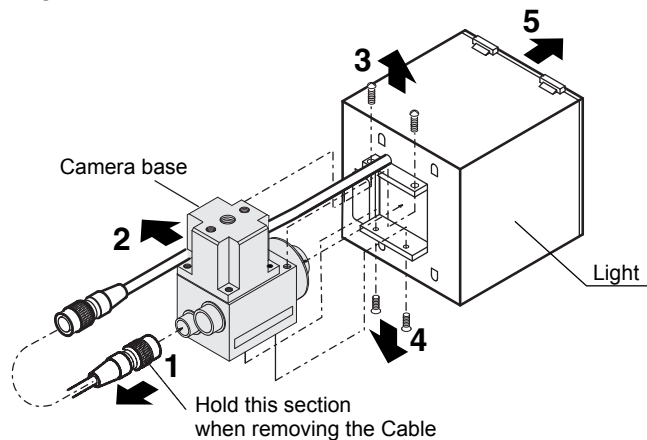

1. Disconnect the light cable from the light connector on the back of the Camera.
2. Remove the light cable from the slot in the camera base.
3. Remove the two screws that secure the Light.
4. Remove the bottom two screws that secure the Light.
5. Remove the Light from the Camera.
6. Reverse the procedure 1 through 5 to install the Light.

NOTICE

Do not disassemble the Lens. Disassembly can damage the Lens.



CHECK!

When using the Camera alone without connecting an Intelligent Lighting (F150-S1A-2D):

The bottom two screws shown in **4.** will be too long and won't fit the Camera. Use two M2 × 3 screws for the bottom screws instead.

The top screws shown in **3.** are not needed.

▪ Installing the Light

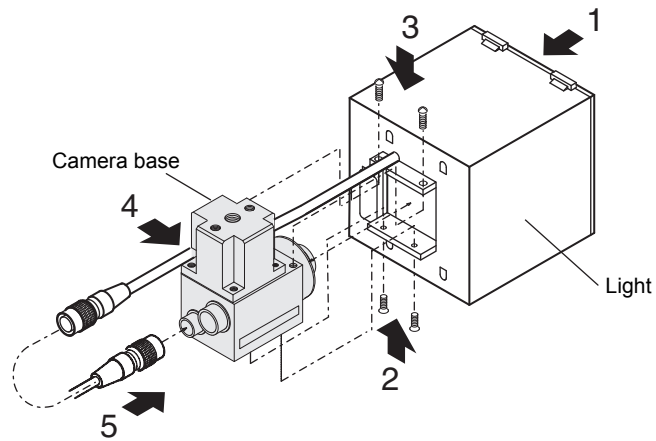

- 1.** Fit the light in the Camera.
- 2.** Replace the bottom two screws that secure the Light.
- 3.** Replace the two screws that secure the Light.
- 4.** Insert the light cable in the slot in the camera base.
- 5.** Connect the light cable to the light connector on the back of the Camera.

Replacing the Battery

The V530-R160 contains a battery that backs up the time and date information. When the battery is nearly discharged, the message “BATTERY LOW” will be displayed at startup. Replace the battery with an OMRON 3Z49-BAT1 Battery.

Dispose of the spent battery properly.

Manufacturer	Model
OMRON	3Z49-BAT1



- Always turn OFF the power supply before replacing the battery.
 - The V530-R160's clock will be reset if the new battery is not connected within 2 minutes of removing the spent battery. If the clock is inadvertently reset, the time and date will have to be set again.
-  Refer to page 188.

1. Open the battery cover on the side of the V530-R160.

The cover can be opened with a small flat-blade screwdriver.

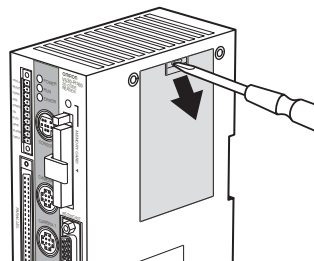

The battery is mounted to the inside of the battery cover.

2. Hold the battery connector by its base and pull it off.

3. Cut the binding band that secures the battery and remove the battery from the cover.

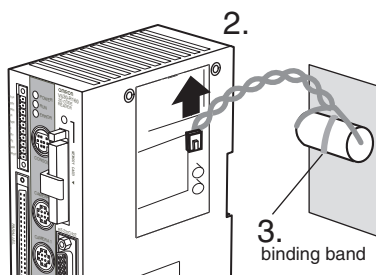

4. Reverse the procedure 1 through 3 to install the new battery.

Use the new binding band included with the new battery to attach it to the battery cover.

WARNING

Battery Precautions

- Do not short circuit, attempt to charge, disassemble, apply pressure that would deform to, or incinerate the lithium battery. The lithium battery may start a fire, explode, or burn if not treated properly.

Regular Inspections

To maintain the V530-R160 in the best condition, perform the following regularly.

- Clean the Lens and LED indicators with a lens-cleaning wipe or blow off dust with an aerosol air sprayer.
- Lightly wipe off dirt with a soft cloth.

Inspection point	Details	Tools required
Power supply	The voltage measured at the power supply terminals on the terminal block must be 20.4 VDC to 26.4 VDC.	Circuit tester
Ambient temperature	The operating ambient temperature inside the cabinet must be between 0 to 50°C.	Thermometer
Ambient humidity	The operating ambient humidity inside the cabinet must be between 35 and 85%.	Hygrometer
Installation	Each cable connector must be correctly inserted and locked. The cameras must be firmly secured. The camera lens mounts must be firmly secured.	Screwdriver
LED lights	All indicators must light when the power is turned ON. <ul style="list-style-type: none"> • Verify that a through-image is displayed. • When using an Intelligent Lighting, verify that the light level settings are set to their maximum values. 	—

NOTICE

- Turn OFF the power and take safety precautions before conducting inspections.
- Do not use thinners or benzene.

Specifications and Dimensions

Controller

V530-R160

(Unit: mm)

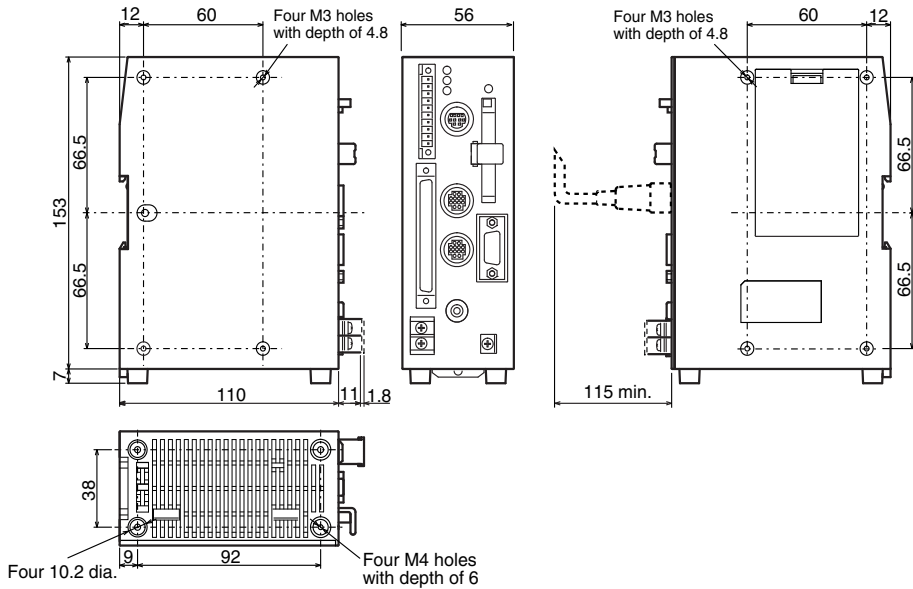

General Specifications	Supply voltage	20.4 to 26.4 VDC
	Current consumption	1.6 A max.
	Insulation resistance	20 MΩ min. between all DC external terminals and GR terminal (with internal surge absorber removed)
	Dielectric strength	1,000 VAC, 50/60 Hz between all DC external terminals and GR terminal (with internal surge absorber removed)
	Leakage current	10 mA max.
	Noise resistance	2000 V; rise time: 5 ns; pulse width: 50 ns Burst continuation time: 15 ms; Period: 300 ms
	Vibration resistance	10 Hz to 150 Hz; half-amplitude: 0.35 mm (maximum acceleration 50 m/s ²) 10 times for 8 minutes each in 3 directions (except for bottom surface-mounting)
	Shock resistance	150 m/s ² 3 times each in 6 directions
	Ambient temperature	Operating: 0 to +50°C Storage: -25 to +65°C (with no icing or condensation)
	Ambient humidity	Operating/storage: 35% to 85% (with no condensation)
	Ambient environment	No corrosive gasses
	Ground	Ground the V530-R160's ground terminal to less than 100 Ω.
	Degree of protection	IEC60529 IP20
Case material	ABS/PC	
Weight	Approx. 570 g (Controller only)	

Camera

F150-S1A-2D

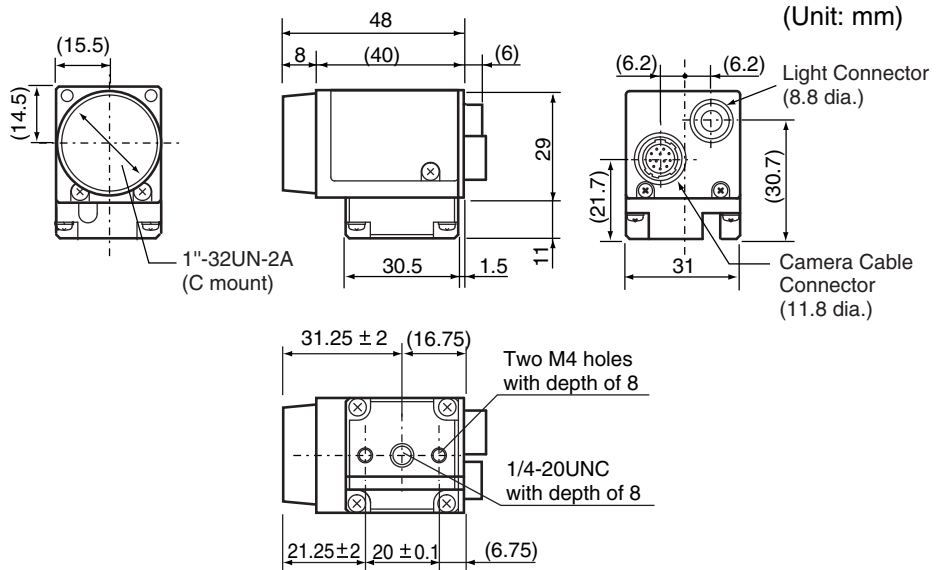

Camera with an Intelligent Lighting

F150-SLC20

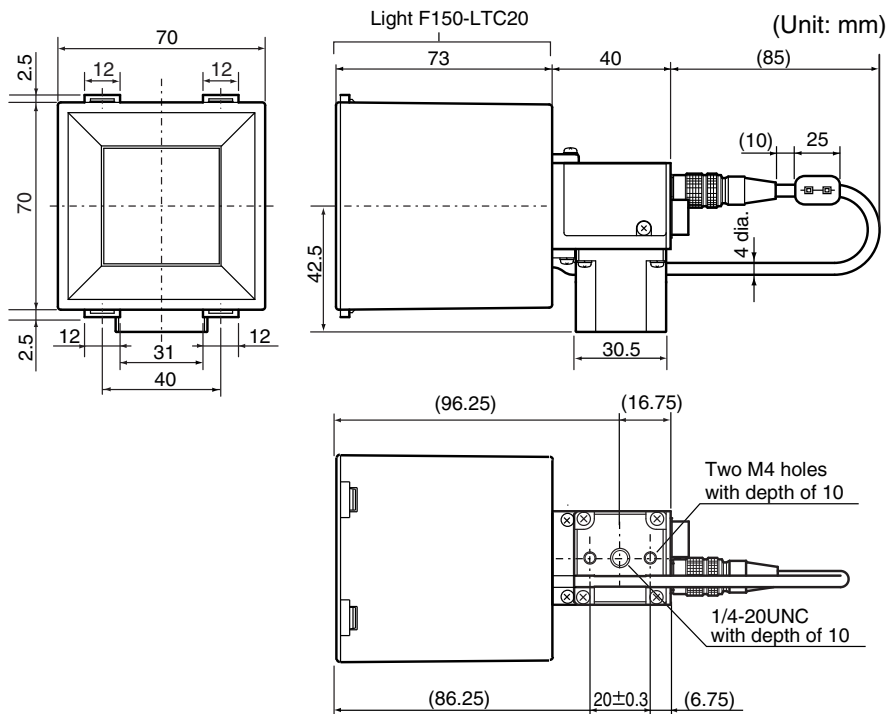

Camera Specifications

		F150-S1A-2D	F150-SLC20	
General Specifications	Supply voltage	12 VDC		
	Current consumption	100 mA max.	200 mA max.	
	Vibration resistance	10 Hz to 150 Hz; half-amplitude: 0.35 mm (maximum acceleration 50 m/s ²) 10 times for 8 minutes each in 3 directions		
	Shock resistance	150 m/s ² 3 times each in 6 directions		
	Ambient temperature	Operating: 0 to +50°C Storage: -25 to +60°C (with no icing or condensation)		
	Ambient humidity	Operating/storage: 35% to 85% (with no condensation)		
	Ambient environment	No corrosive gasses		
	Camera materials	Cover: Zinc-plated steel sheet, t0.6 (SECC-C) Case: Die-cast aluminium alloy (ADC 12) Mounting base: Bakelite containing cloth (back)		
	Light materials	-	Case: ABS Transparent aperture: PC	
Performance Specifications	Camera Characteristics	Picture element	1/3" interline CCD (reading all pixels)	
		Effective pixels	659 × 494 (H × V)	
		Synchronization	External sync. Via horizontal sync signal	
		Shutter speed (Electronic shutter)	Electronic shutter: 1/100, 1/500, 1/2000, 1/10000 sec.	
		Lens mount	C mount	
	Lens Characteristics	Lens model	-	F150-LE20
		System		Fixed focal point, fixed iris
		Brightness		F2.8
		Focal point distance		13 mm
	Light Characteristics	Light model	-	F150-LTC20
		Light		Red and green LED combination (Peak emission wavelength: 660 nm and 570 nm)
		Light emission method		Pulse emission (synchronized with the camera shutter)
	Mounting distance	(Depends on the lens)	15 to 25 mm	
	Field of vision		20 mm × 20 mm	
Weight		Approx. 80 g	Approx. 280 g	

Console F150-KP-2D

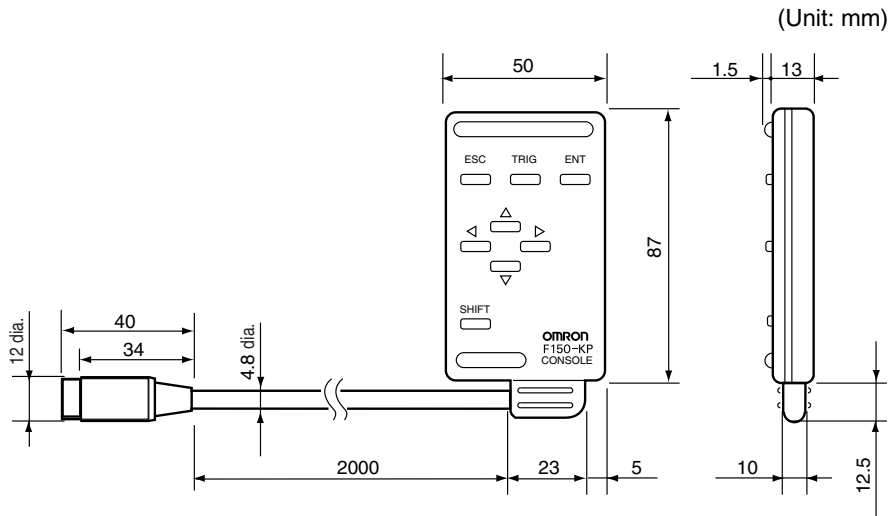

General Specifications	Vibration resistance	10 Hz to 150 Hz; half-amplitude: 0.15 mm 4 times for 8 minutes each in 3 directions
	Shock resistance	196 m/s ² 3 times each in 6 directions
	Ambient temperature	Operating: 0 to +50°C Storage: -25 to +65°C (with no icing or condensation)
	Ambient humidity	Operating/storage: 35% to 85% (with no condensation)
	Ambient environment	No corrosive gasses
	Degree of protection	IEC60529 IP20 (in-panel)
	Minimum bending radius	75 mm
	Materials	Body: ABS Cable sheathing: Heat-resistant vinyl chloride Connector: PC, PBT
Weight	Approx. 135 g	

Camera Cable (For F150-S1A-2D Camera)

F150-VS-2D

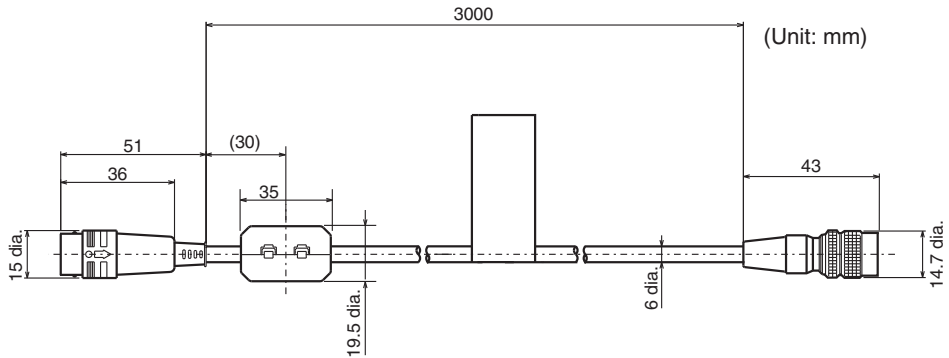

General Specifications	Vibration resistance	10 Hz to 150 Hz; half-amplitude: 0.15 mm 4 times for 8 minutes each in 3 directions
	Shock resistance	196 m/s ² 3 times each in 6 directions
	Ambient temperature	Operating: 0 to +50°C Storage: -25 to +65°C (with no icing or condensation)
	Ambient humidity	Operating/storage: 35% to 85% (with no condensation)
	Ambient environment	No corrosive gasses
	Materials	Cable sheathing: Heat-resistant vinyl chloride Connector: Fiberglass-reinforced PC, PBT
	Minimum bending radius	75 mm
Weight	Approx. 170 g	

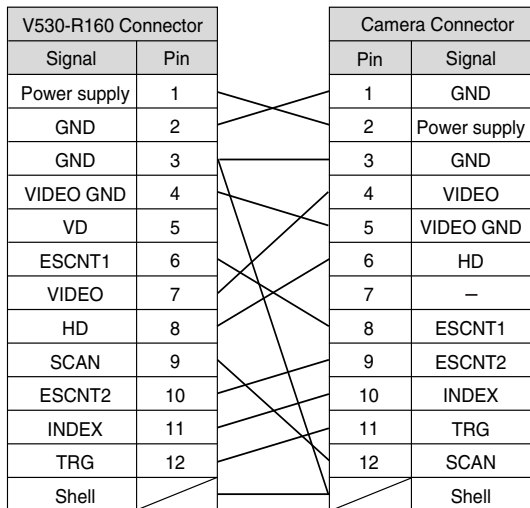

Connector model:
Hirose RP17A-13PA-12PC(71)

Connector model:
Hirose HR10A-10P-12SC(73)

Monitor Cable

F150-VM-2D

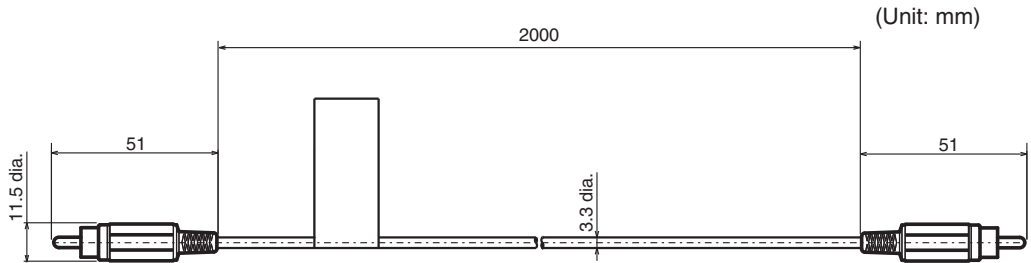

General Specifications	Vibration resistance	10 Hz to 150 Hz; half-amplitude: 0.15 mm 4 times for 8 minutes each in 3 directions
	Shock resistance	196 m/s ² 3 times each in 6 directions
	Ambient temperature	Operating: 0 to +50°C Storage: -25 to +65°C (with no icing or condensation)
	Ambient humidity	Operating/storage: 35% to 85% (with no condensation)
	Ambient environment	No corrosive gasses
	Materials	Cable sheathing: Ultra flame-resistant vinyl chloride Connector: PVC
	Minimum bending radius	50 mm
Weight	Approx. 40 g	
Accessory	BNC jack	

Parallel I/O Cable

F160-VP

(Unit: mm)

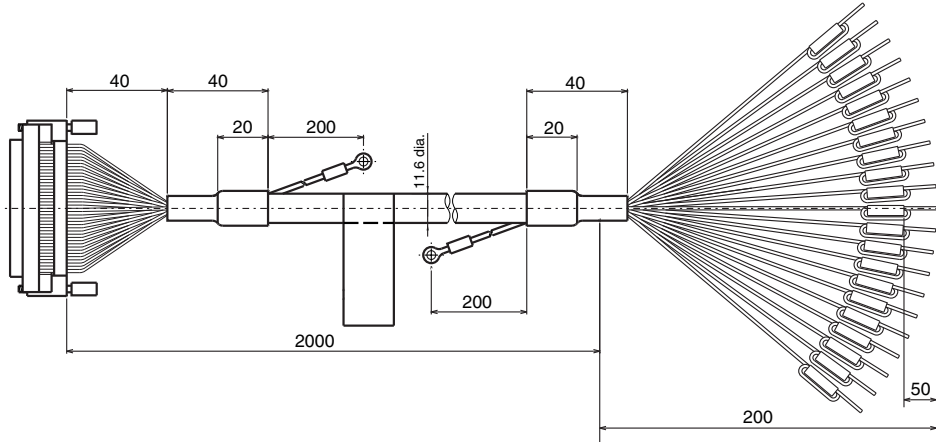

General Specifications	Vibration resistance	10 Hz to 150 Hz; half-amplitude: 0.15 mm 4 times for 8 minutes each in 3 directions
	Shock resistance	196 m/s ² 3 times each in 6 directions
	Ambient temperature	Operating: 0 to +50°C Storage: -25 to +65°C (with no icing or condensation)
	Ambient humidity	Operating/storage: 35% to 85% (with no condensation)
	Ambient environment	No corrosive gasses
	Materials	Cable sheathing: Heat-resistant PVC Connector: Polyester resin
	Minimum bending radius	120 mm
Weight	Approx. 340 g	

LCD Color Monitor F150-M05L-2D

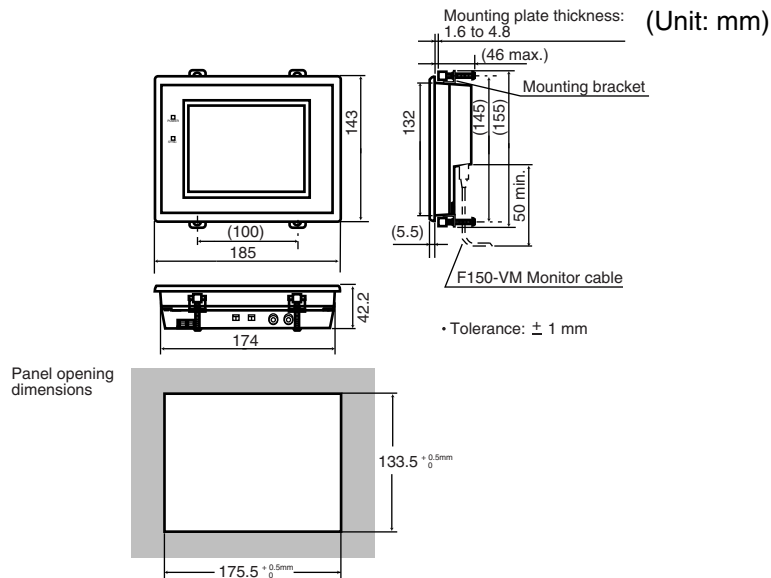

General Specifications	Supply voltage	20.4 to 26.4 VDC
	Current consumption	700 mA max.
	Vibration resistance	10 Hz to 150 Hz; half-amplitude: 0.1 mm (maximum acceleration 15 m/s ²) 10 times for 8 minutes each in 3 directions
	Shock resistance	150 m/s ² 3 times each in 6 directions
	Ambient temperature	Operating: 0 to +50°C Storage: -25 to +65°C (with no icing or condensation)
	Ambient humidity	Operating/storage: 35% to 85% (with no condensation)
	Ambient environment	No corrosive gasses
	Degree of protection	IEC60529 IP20
	Materials	Case: ABS/PC Display: PMMA (acrylic)
Performance Specifications	Panel size	5.7 inches; 116.16 (H) × 87.12 (V) mm
	Panel type	TFT color liquid crystal
	Resolution	620 × 480 dots
	Image pitch	0.1815 (H) × 0.1815 (V) mm
	Contrast	850:1 (TYP)
	Viewable angle	80° up/down and 80° left/right (with a contrast ratio >10:1)
	Luminance	400 cd/m ² (TYP)
	Backlight	LED
	Response speed	18 ms max.
	Input signal	NTSC composite video (1.0 V/75 Ω termination)
Weight	Approx. 1 kg	
Accessory	4 mounting brackets	

Memory Card

F160-N64S(S)

QM300-N128S

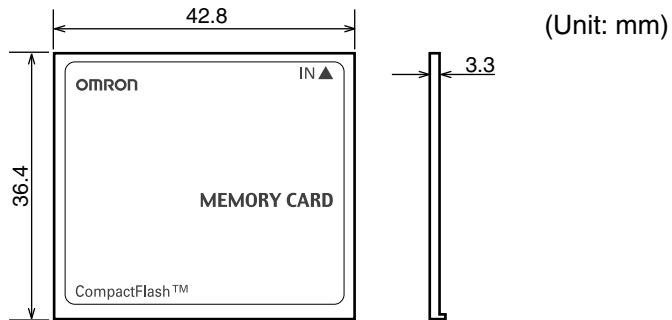

General Specifications	Ambient temperature	Operating: 0 to +60°C Storage: -25 to +85°C (with no icing or condensation)
	Ambient humidity	Operating/storage: 8% to 95% (with no condensation)
	Ambient environment	No corrosive gasses
	Life expectancy	300,000 overwrite operations
	Number of pins	50 pins
	Weight	Approx. 15 g

ASCII Codes

Data read with **Normal** commands of the serial interface is output in two characters of ASCII code. The ASCII codes correspond to the following characters.

Example: When the reading data is **A** **41** is output.
When the reading data is **T** **54** is output.

		Most significant 4 bits							
		0	1	2	3	4	5	6	7
Least significant 4 bits	0		D _E		0	@	P	`	p
	1	S _H	D ₁	!	1	A	Q	a	q
	2	S _X	D ₂	”	2	B	R	b	r
	3	E _X	D ₃	#	3	C	S	c	s
	4	E _T	D ₄	\$	4	D	T	d	t
	5	E _Q	N _K	%	5	E	U	e	u
	6	A _K	S _N	&	6	F	V	f	v
	7	B _L	E _B	'	7	G	W	g	w
	8	B _S	C _N	(8	H	X	h	x
	9	H _T	E _M)	9	I	Y	i	y
	A	L _F	S _B	*	:	J	Z	j	z
	B	H _M	E _C	+	;	K	[k	{
	C	C _L	↓	,	<	L	\	l	!
	D	C _R	↑	-	=	M]	m	}
	E	S _O	→	.	>	N	^	n	~
	F	S _I	←	/	?	O	_	o	

FCS Check Program Examples (BASIC)

■ Calculation Examples for Sending FCS

DATA\$	Sample Data Line
L	Data Length
CODE\$	Data Character
A	Exclusive Operation

```

100      '*****CALCULATE FCS*****
110      '*FCSSET
120      L=LEN(DATA$)
130      A=0
140      FOR J=1 TO L
150      CODE$=MID$(DATA$,J,1)
160      A=ASC(CODE$)XOR A
170      NEXT J
180      FCS$=HEX$(A)
190      IF LEN(FCS$)=1 THEN FCS$="0"+FCS$
200      RETURN

```

■ FCS Check Sub Routine Examples for Received Data

```

1000     '*****FCSHECK*****
1010     '*FCSHECK
1020     Q=0:FCSCCK$="OK"
1030     PRINT RESPONSE $
1040     LENG$=LEN(RESPONSE$)-3
1050     FCSP$=MID$(RESPONSE$,LENG$+1,2)      'Response data of FCS
1060     FOR J=1 TO LENG$                      'Calculation range of FCS'
1070     Q=ASC(MID$(RESPONSE$,J,1))XOR Q
1080     NEXT J
1090     FCSD$=HEX$(Q)
1100     IF LEN(FCSD$)=1 THEN FCSD$="0"+FCSD$  'FCS calculated in a program
1110     IF FCSD$<> FCSP$ THEN FCSCCK$="ERR"
1120     PRINT "FCSD$=";FCSD$;"FCSP$=";FCSP$;
           "FCSCCK$=";"FCSCCK$="          'FCS correctly received: OK
1130     RETURN                                'FCS not received correctly: ERR

```



Data Capacity Tables

The maximum quantity of information that can be stored varies depending on the matrix size of the code. In regard to the information carried by the code, the maximum data capacity varies depending on the character type and the arrangement and combination of the characters. The relation between matrix size (number of cells) and data capacity is shown in the table below.

■ DataMatrix

- DataMatrix (ECC200)

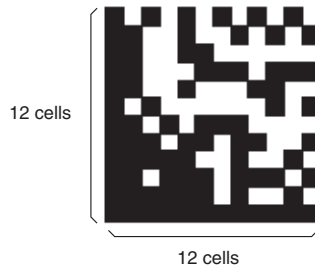
In the diagram below, the matrix size is 12×12 .



Matrix size	Data Capacity				
	Numerals	Alphanu- meric charac- ters	Alphanumer- ics and sym- bols	KANJI (2-byte)	KANA (1-byte)
10 × 10	6	3	3	–	1
12 × 12	10	6	5	1	3
14 × 14	16	10	9	3	6
16 × 16	24	16	14	5	10
18 × 18	36	25	22	8	16
20 × 20	44	31	28	10	20
22 × 22	60	43	38	14	28
24 × 24	72	52	46	17	34
26 × 26	88	64	57	21	42
32 × 32	124	91	81	30	60
36 × 36	172	127	113	42	84
40 × 40	228	169	150	56	112
44 × 44	288	214	190	72	142
48 × 48	348	259	230	86	172
52 × 52	408	304	270	101	202
64 × 64	560	418	372	139	278
8 × 18	10	6	5	1	3
8 × 32	20	13	12	4	8
12 × 26	32	22	20	7	14
12 × 36	44	31	28	10	20
16 × 36	64	46	41	15	30
16 × 48	98	72	64	23	47



What is Maximum Data Capacity?  Refer to page 284.

• DataMatrix (ECC100-140)

Example: ECC100

In the diagram below, the matrix size is 15×15 .

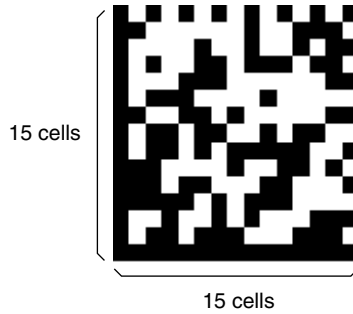

▪ ECC000

Matrix size	Data Capacity		
	Numerals	Alphanu- meric charac- ters	KANA (1-byte)
9 × 9	3	2	1
11 × 11	12	8	5
13 × 13	24	16	10
15 × 15	37	25	16
17 × 17	53	35	23
19 × 19	72	48	31
21 × 21	92	61	40
23 × 23	115	76	50
25 × 25	140	93	61

▪ ECC050

Matrix size	Data Capacity		
	Numerals	Alphanu- meric charac- ters	KANA (1-byte)
11 × 11	1	1	-
13 × 13	10	6	4
15 × 15	20	13	9
17 × 17	32	21	14
19 × 19	46	30	20
21 × 21	61	41	27
23 × 23	78	52	34
25 × 25	97	65	42



What is Maximum Data Capacity?  Refer to page 284.

▪ ECC080

Matrix size	Data Capacity		
	Numerals	Alphanu- meric charac- ters	KANA (1-byte)
13 × 13	4	3	2
15 × 15	13	9	6
17 × 17	24	16	10
19 × 19	36	24	16
21 × 21	50	33	22
23 × 23	65	43	28
25 × 25	82	54	36

▪ ECC100

Matrix size	Data Capacity		
	Numerals	Alphanu- meric charac- ters	KANA (1-byte)
13 × 13	1	1	–
15 × 15	8	5	3
17 × 17	16	11	7
19 × 19	25	17	11
21 × 21	36	24	15
23 × 23	47	31	20
25 × 25	60	40	26

▪ ECC140

Matrix size	Data Capacity		
	Numerals	Alphanu- meric charac- ters	KANA (1-byte)
17 × 17	2	1	1
19 × 19	6	4	3
21 × 21	12	8	5
23 × 23	17	11	7
25 × 25	24	16	10

■ **QRCode**

- QRCode (Model 2)

In the diagram below, the matrix size is 21 × 21.

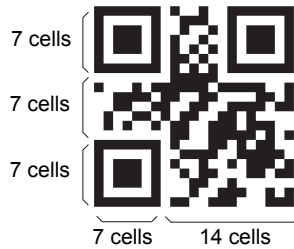



Matrix size (Version)	Error Correction Level	Data Capacity			
		Numerals	Alphanu- meric charac- ters (upper case)	8 bit binary	KANJI (2-byte)
21 × 21 (Version 1)	L (7%)	41	25	17	10
	M (15%)	34	20	14	8
	Q (25%)	27	16	11	7
	H (30%)	17	10	7	4
25 × 25 (Version 2)	L (7%)	77	47	32	20
	M (15%)	63	38	26	16
	Q (25%)	48	29	20	12
	H (30%)	34	20	14	8
29 × 29 (Version 3)	L (7%)	127	77	53	32
	M (15%)	101	61	42	26
	Q (25%)	77	47	32	20
	H (30%)	58	35	24	15
33 × 33 (Version 4)	L (7%)	187	114	78	48
	M (15%)	149	90	62	38
	Q (25%)	111	67	46	28
	H (30%)	82	50	34	21
37 × 37 (Version 5)	L (7%)	255	154	106	65
	M (15%)	202	122	84	52
	Q (25%)	144	87	60	37
	H (30%)	106	64	44	27
41 × 41 (Version 6)	L (7%)	322	195	134	82
	M (15%)	255	154	106	65
	Q (25%)	178	108	74	45
	H (30%)	139	84	58	36





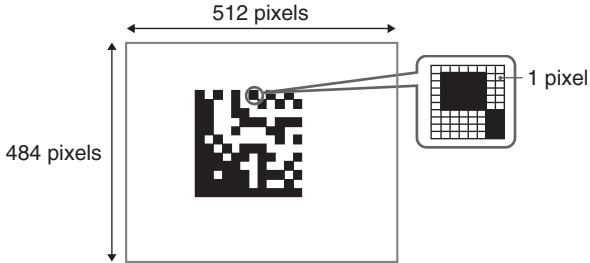

What is Maximum Data Capacity? Refer to page 284.

Glossary

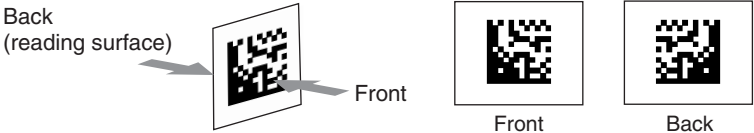
This glossary focuses on terms related to QR Codes and DataMatrix codes which are matrix-type 2-dimensional codes. There may be some parts of this glossary that do not apply to other types of 2-dimensional codes.

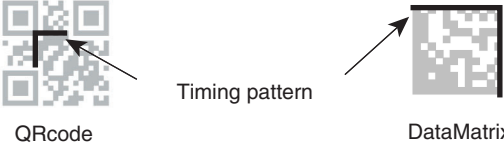
Glossary	Explanation
DataMatrix	<p>DataMatrix codes were developed by I.D. Matrix, and are used extensively in the semiconductor and electronics industries. DataMatrix codes have a relatively large data capacity for their size. There are several different types of DataMatrix, differentiated by their error correction method. The ECC200 is the most commonly used type.</p> 
QRCode	<p>The "Quick Response Code" type is a 2-dimensional code that was developed in Japan. High-speed reading is possible with QR Codes, but the code size is quite large compared to other 2-dimensional codes.</p> 
Error correction	<p>This term is used to describe the function which detects and corrects errors using a special mathematical technique (commonly known as the "Read-Solomon" method). Using this function, reading is possible, to a certain extent, for codes with poor printing quality or that are damaged. There are, however, limits on the extent to which correction is possible, and reading may not be possible for codes if the damage is extensive. There are 2-dimensional codes for which the error correction level can be selected. (For example: With QR Codes, error correction levels of 7%, 15%, 25%, or 30% are available.)</p>
Pixel	<p>Pixels are the points that make up images. The monitor screen is 512 pixels high and 484 pixels wide which means that the screen contains approximately 250,000 pixels.</p> 

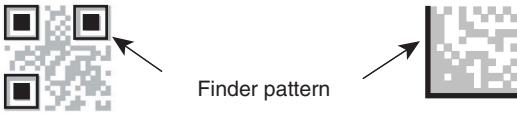
Glossary	Explanation
Maximum data capacity	<p>The maximum amount of data that can be stored in a code varies with the code size. In other words, if there is a large amount of data to be stored, then the code size must also be large.</p> <p>The maximum data capacity will also vary with the type of characters used. With QR Codes and DataMatrix codes, the numeric capacity (numbers only) is larger than the alpha numeric capacity (numbers and letters). The capacity also varies in accordance with the character type and the arrangement and combination of the characters.</p>
Right and left reversal	<p>This is the term used to describe reading 2-dimensional codes marked on a transparent material from the reverse side. To give an example, if a 2-dimensional code that is marked on glass is read from the rear surface, it will be reversed in the left/right direction.</p> 
Black and white reversal	<p>Usually, in images of 2-dimensional codes, the code itself is black and the background is white. Sometimes, however, due to the material of the reading object and the kind of lighting used, the code will appear white in the image obtained. This phenomenon is called "black and white reversal."</p>  <p>Code: Black Background: White</p> <p>Code: White Background: Black</p>
Cell	<p>These squares are the units that make up matrix-type 2-dimensional codes. Whether these cells are black or white determines the information carried by the code.</p>
Timing pattern	<p>These patterns are used to determine symbol density and horizontal and vertical dimensions and thereby obtain a frame of reference for 2-dimensional codes. The timing patterns are straight lines composed of alternating black and white cells.</p>  <p>QRcode</p> <p>DataMatrix</p>
Version (QRCode)	<p>The code size of QR Codes is indicated by the version. Version 1 indicates that a QR Code contains the minimum 21 cells both horizontally and vertically. The larger the version number, the larger the number of cells per side.</p>

Glossary	Explanation
<p>Pattern search</p>	<p>This is a method for locating finder patterns. Images of finder patterns are registered as models in advance and searches are made for similar parts of input images. The degree of similarity is expressed as a correlation value (0 to 100). The more similar the pattern, the higher the correlation value. The place with the highest correlation value out of places with a correlation value over a set threshold value is deemed to be the finder pattern.</p> <p>If it is not possible to detect a finder pattern, decrease this threshold value. If too many finder patterns are detected, increase this threshold value.</p>
<p>Finder pattern (Starting symbols)</p>	<p>These are patterns used to detect the position of 2-dimensional codes. The shape of the finder patterns varies with the type of code.</p> <div style="text-align: center;">  <p>QRcode Finder pattern DataMatrix</p> </div>
<p>Resolution</p>	<p>The resolution is a measure of the detail with which images are displayed. The V530-R160 can display images (via a monitor) using approximately 250,000 pixels (512 × 484). This means that if the field of vision is 512 mm × 484 mm, the resolution will be 1 (mm/pixel).</p>
<p>Marking methods</p>	<p>There are several marking methods that can be used. The most suitable method will depend on factors such as the material of the object onto which the code is marked.</p> <p>The most commonly used marking devices are listed below.</p> <ul style="list-style-type: none"> • Engraving machine A pneumatic pen is controlled with compressed air to mark a metal surface by engraving. • Printer A printer can be used to print codes onto paper and different kinds of labels. • Laser Marker A laser marker can be used to mark metal objects. A laser marker can mark very finely enabling the size of 2-dimensional codes can be reduced. • Exposure Marking Using exposure marking, particles are not created (unlike laser marking) and even finder marking is possible than with laser marking. Exposure marking is used with semiconductor wafers, LCD panels, and color filters that have exposure processing.
<p>Margin</p>	<p>This is the empty space around 2-dimensional codes. The OMRON V530-R160 can read codes with a 1-cell margin.</p> <div style="text-align: center;">  <p>■ The black area is the margin.</p> </div>

MEMO

Numerics

1:1 connection	216
1:1 Connection (Personal Computer)	62
1:1 Connection (Programmable Controller)	63
1:N connection	225
1:N Connection (Multi-drop)	64
2 cameras can be used for reading.	29

A

A maximum of ten patterns can be registered for one scene.	30
A memory card slot is provided.	29
Adding Comments to Scenes	148
Adjusting Light Levels by Segment	102
Adjusting the Image (Image Adjust)	92
Ambient Temperature	10
ASCII Codes	277
Auto Pattern Select	113

B

Backing Up Data	149
Backing Up Data to a Computer	151
Backing Up Data to a Memory Card	158
Backing Up to Flash Memory	150
Basic Knowledge of Operations	70
Basic Screen Configuration	71
Basic System Configuration	36
BGS Levels	98
Bottom Surface-mounting	42

C

Cable Wiring	
(XW2Z-200S-V/XW2Z-500S-V)	62
Cable Wiring 1 (RS-232C (Connection between the Host and Link Adapter))	64
Cable Wiring 2 (RS-422 (Connection between a Controller and Branching Link Adapter, or between Branching Link Adapter))	65
Calculation Examples for Sending FCS	278
Camera	269
Camera Cable (For F150-S1A-2D Camera)	272
Camera Specifications	270
Camera with an Intelligent Lighting	269
Cameras	10

Cameras and Cables	10
Cameras, Lenses, Lighting, and Memory	
Cards	46
CCTV Lenses	47
Changing File Names	169
Changing Options	73
Changing Scenes (Scene Function)	144
Changing Test Character String and Echo	
Back	175
Checking File Properties	168
Checking I/O Status with Host Devices (I/O Monitor)	173
Checking the Version (Version)	189
Clean the Lens and LED indicators with a lens-cleaning wipe or blow off dust with an aerosol air sprayer.	267
Code Settings	108, 137
Command Format	216
Command List	212, 240
Component Installation and Handling	10
Component Names and Functions	38
Conditions Settings	251
Confirming Package Contents	12
Connecting a Camera	43
Connecting a Console	43
Connecting a Monitor	43
Connecting Method	54
Connecting Peripheral Devices	43
Connecting through the Parallel I/O	54
Connecting through the Serial Interface	60
Connection	66
Connection Examples	62
Connection Examples for Programmable Controller	244
Connection Examples for Programmable Controller (Normal)	229
Connector	61
Console	271
Continuous Reading	197
Continuous Reading (Level Trigger)	198
Controller	268
Controller Installation Site	8
Copying Files	166
Copying Reading Conditions	146
Countermeasure Examples	252
Creating Directories	163
Crimp Terminals and Cables	44
CSV Format	126

D

Data Capacity Tables	279
DataMatrix	117, 279
DataMatrix explanatory diagram	254
DataMatrix Reading	253

Deleting Files and Directories	171
Detail Data	116
DIN Track Mounting	39
Display capture results	185
Display Captures	185
Display Settings	114, 141
Display the Trend Monitor	122
Dot code images can be converted to easy-to-read images.	30

E

ECC000	280
ECC050	280
ECC080	281
ECC100	281
ECC140	281
Entering System Mode	180
Entering the SET Mode	79
Environment and Setup	250
Error Codes and Countermeasures	253
Error Messages and Corresponding Corrective Actions	257
Execution keys	185
Extension Tube	48

F

F150-KP-2D	271
F150-M05L-2D	275
F150-S1A-2D	269
F150-SLC20	269
F150-SLC20 Maintenance	264
F150-VM-2D	273
F150-VS-2D	272
F160-N64S(S)	276
F160-VP	274
FCS Calculation	228
FCS Check Program Examples (BASIC)	278
FCS Check Sub Routine Examples for Received Data	278
Filtering	94
Filtering Retry	96
Flow Charts	203, 233
Flow Control Settings	208
Format	241
FP & Cell Position	118

G

General Safety Precautions	24
----------------------------	----

Glossary	283
Ground Wiring	44
Guidance	116

I

I/O Connector Connections	56
I/O Format	214, 240
I/O Terminal Connections	54
Image data can be backed up automatically.	31
Image Storage Conditions	183
Improving Reading	250
Initializing Reading Conditions (Clearing Scenes)	147
Input Devices	70
Input Format	240
Input in the BUSY Status	187
Inputting Characters	75
Inputting Values	74
Installing a Memory Card	51
Installing location of the V530-R160	8
Installing the Light	265
Integration of Objects and Data	26
Internal Specifications	58
Interpreting the Graph	47
Introduction to Functions	28

L

Ladder Program Example	247
LCD Color Monitor	275
Lenses and Lens Diameters	48
Level Trigger Reading	201
Light Control	100
Light Control Screen	101
Light volume	101
Lighting	49, 50
Lightly wipe off dirt with a soft cloth.	267
Line speed	201
Loading Data	155
Loading Data from the Memory Card (Memory Card to V530-R160)	161

M

Maintaining and Changing a Camera with a Light	264
Maintenance	264
Making a Parallel I/O Cable	58
Memory Card	51, 276
Memory Card Operations	163

MON mode	202
Monitor Cable	273
Mounting Orientation	9
Mounting the Controller	39
Multi Drop Settings	209

N

NG judgement after repeated reading	199
Noise Resistance	10
Number of retries	201

O

OK judgement obtained after repeated reading	199
OMRON Components	10
One Shot Reading	195
Operational Flow	32
Optical Chart	47
Output Format	195, 243
Overview of Available Cameras	46

P

Parallel I/O	192
Parallel I/O Cable	274
Parallel I/O Interface	176
Pattern Registration	105, 130
Pattern Settings	104, 129
Perform Tests	87
Points to Check before Starting Communications	60
Power Supply and Ground	44
Processing Time Calculation	200
Program Examples	203, 231, 246

Q

QM300-N128S	276
QRCode	117, 282
QRCode explanatory diagram	256
QRCode Reading	255

R

Reading	116
Reading Data	116
Reading Data Output Format	227

Reading is possible for both DataMatrix and QRCode.	28
Reading Moving Objects	200
Reading Settings	112, 141
Rear Surface-mounting	40
Recommended Wire Size	54
Reference Pattern	110, 139
Referring to NG Reading Results (Warning Transition)	125
Registering Models of Finder Pattern	81
Regular Inspections	267
Regulations and Standards	10
Removing the Controller	39
Removing the Light	264
Removing the Memory Card	11, 52
Replacing the Battery	266
RS-232C Cable Wiring (XW2Z-200T/XW2Z-500T)	63, 229, 244
RS-422 Block Diagram	61
RUN mode	202

S

Sample lighting pattern number	101
Save Settings and Exit the V530-R160	90
Saving Data	151
Saving Data to a Memory Card (V530-R160 to Memory Card)	158
Saving Reading Data (Store Data to Memory Card)	126
Screen Displays	71
Search Region	111, 140
Searching from the Menu Tree	22
Segment display	101
Select the Code and Capture the Image	76
Select the Object whose Data is to be Displayed by the Trend Monitor (Object of Monitoring)	120
Selecting a Light	49
Selecting Shutter Speed	80
Selecting the Conditions for Image Storage (Image Storing)	182
Serial Interface	173
Serial Interface (Host Link)	232
Serial Interface (Normal)	202
SET mode	202
Set Reading Conditions	79
Setting Communications Specifications	192, 206, 236
Setting Reading Conditions (DataMatrix)	104
Setting Reading Conditions (QRCode)	129
Setting Reading Conditions for Different Codes (Changing Scenes)	144

Setting Startup Conditions (Startup Mode)	186
Setting the Calendar Date and Time (Date/Time)	188
Setting the Communication Speed and Communication Mode	236
Settings at the Controller	230, 245
Settings at the Programmable Controller	230, 245
Settings for Data Output	210
Settings Relating to Programmable Controllers	238
Settings Relating to the Camera and Monitor (Camera/Monitor)	181
Shutter Speed	93
Side Surface-mounting	41
Specifications and Dimensions	268
Start Reading	88
Starting the Controller	68
Storage in Memory Cards	184
Switching Cameras	92
System Configuration	229, 244
System Examination	200

T

Tact time	201
The Marking can be Done in a Small Space	27
The reading results over time can be expressed in the form of a graph.	31
Timing Charts	195
To delete a pattern	107, 136
Touching Signal Lines	11
Trend Monitor Settings	119, 141
TRIG A Signal as Reading Trigger	205, 234
Trigger Input	194
Trigger Input and Output Formats	194
Troubleshooting	261
Turning OFF the Power	11
Turning OFF the Power Supply to the Memory Card	172

U

Understanding Setting Operations	76
Using a Sample Lighting Pattern	102
Using BUSY Signals (Error Method)	187
Using Memory Cards in a Personal Computer	52
Using the RESET Signal	11
Using TXD Instructions	235

V

V530-R160	268
Visual Aids	14

W

What is a 2-dimensional Code Reader? 26	
When the reading is performed correctly	198
When the Serial Interface is used for both Input and Output	203, 233
Wiring the Power Supply	45

Revision History

A manual revision code appears as a suffix to the catalog number on the front cover of the manual.

Cat. No. Z169-E1-04
↑
Revision code

The following table outlines the changes made to the manual during each revision. Page numbers refer to the previous version.

Revision code	Date	Revised content
1	October 2002	Original production
02	April 2004	Inner front cover: Information removed at top of page and trademark credit added at bottom of page. Page 1: Section of precautions added after this page (moved from pages 11 to 22 and revised). Page 15: Contents of notice changed. Page 45: End of first paragraph changed. First sentence in second paragraph changed. "Camera distance" changed to "working distance." Page 222: One diagram corrected and one added.
02A	November 2004	Pages 2 to 4: Warranty and liability information changed. Page 6: Precaution added.
03	May 2006	Pages 11 and 272: Description on Video Monitor deleted. Pages 36 and 45: Power Supply model number changed. Page 36: Monitor cable connector changed. Page 36: Graphic of Video Monitor deleted and note added at bottom graphic. Pages 43, 68, 241, and 269: Monitor cable connector changed. Page 228: Descriptions of commands in ladder program changed.
03A	May 2007	Page 212: Title changed from I/O Format to Command List. Description of input format deleted. Page 213: I/O format information updated. Page 214: Command format header added. Page 223: @GL and @RD information added for 1:N (Multi Drop) Connection. Pages 229 and 230: "CHECK!" items added. Page 240: Reference note for error code details added. Page 249: Description of Error Codes and Countermeasures changed.
03B	October 2010	Minor corrections
03C	March 2012	Page 6: Additions for Notice for Korea Radio Law
04	August 2015	Additions corresponding to change of EN standard.

OMRON Corporation Industrial Automation Company
Kyoto, JAPAN

Contact: www.ia.omron.com

Regional Headquarters

OMRON EUROPE B.V.

Wegalaan 67-69, 2132 JD Hoofddorp
The Netherlands
Tel: (31)2356-81-300/Fax: (31)2356-81-388

OMRON ELECTRONICS LLC

2895 Greenspoint Parkway, Suite 200
Hoffman Estates, IL 60169 U.S.A.
Tel: (1) 847-843-7900/Fax: (1) 847-843-7787

OMRON ASIA PACIFIC PTE. LTD.

No. 438A Alexandra Road # 05-05/08 (Lobby 2),
Alexandra Technopark,
Singapore 119967
Tel: (65) 6835-3011/Fax: (65) 6835-2711

OMRON (CHINA) CO., LTD.

Room 2211, Bank of China Tower,
200 Yin Cheng Zhong Road,
PuDong New Area, Shanghai, 200120, China
Tel: (86) 21-5037-2222/Fax: (86) 21-5037-2200

Authorized Distributor:

© OMRON Corporation 2002 All Rights Reserved.
In the interest of product improvement,
specifications are subject to change without notice.

Cat. No. Z169-E1-04

0815