

IoT Status Monitoring Amplifier

E9NC-AA/VA

IoT Status Monitoring Amplifiers for General-purpose Analog Outputs Are Connectable to Various Sensors



- General-purpose input: Connectable to sensor heads with analog output between 1 to 5 VDC (voltage) or 4 to 20 mA DC (current) for measurements.
- Scaling: Convert analog input to a desired value for display (Upper limit setting: -1999.9999 to 9999.9999)
- No. of connectable units: Max. 30 *

* The maximum number of connectable units varies depending on conditions such as the current consumption of the sensor head.







For the most recent information on models that have been certified for safety standards, refer to your OMRON website.



Refer to the *Safety Precautions* on page 7.

Ordering Information

Amplifier unit [Refer to *Dimensions* on page 9.]

Type	Appearance	Connection method	Output	Model	
				NPN output	PNP output
Current input		Connector for Sensor Communications Unit	2 outputs	E9NC-AA0	
		Connector for Sensor Communications Unit Pre-wired (2 m)	1 output	E9NC-AA10 2M	E9NC-AA40 2M
Voltage input		Connector for Sensor Communications Unit	2 outputs	E9NC-VA0	
		Connector for Sensor Communications Unit Pre-wired (2 m)	1 output	E9NC-VA10 2M	E9NC-VA40 2M

* A Sensor Communications Unit is required if you want to use the Amplifier Unit on a network.

Accessories (Sold Separately)

DIN Track [Refer to *Dimensions on page 10.*]

A DIN Track is not provided with the Fiber Amplifier Unit. It must be ordered separately as required.

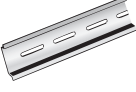

Appearance	Type	Model	Quantity
	Shallow type, total length: 1 m	PFP-100N	1
	Shallow type, total length: 0.5 m	PFP-50N	
	Deep type, total length: 1 m	PFP-100N2	

Note: For details, refer to DIN Track on PFP-□ which can be accessed from your OMRON website.

End Plate [Refer to *Dimensions on page 10.*]



Two End Plates (PFP-M) are provided with the Sensor Communications Unit.

End Plates (PFP-M and E39-EP1) are not provided with the Amplifier Unit. They must be ordered separately as required.

Appearance	Model	Quantity	Applicable Amplifier Unit
	PFP-M	1	E9NC-AA0 E9NC-VA0
	E39-EP1	1	E9NC-AA10 E9NC-AA40 E9NC-VA10 E9NC-VA40

Related products

Sensor Communications unit

Type	Appearance	Model
EtherCAT sensor communications unit		E3NW-ECT
Sensor Communications Unit for CC-Link		E3NW-CCL
Distributed Sensor Unit *		E3NW-DS

Refer to your OMRON website for details.

* The Distributed Sensor Unit can be connected to any of the Sensor Communications Units.

EtherCAT® is a registered trademark and patented technology, licensed by Beckhoff Automation GmbH, Germany.
CC-Link is a registered trademark of Mitsubishi Electric Corporation. The trademark is managed by the CC-Link Partner Association.

Ratings and specifications

Item	Types	Current input		Voltage input	
		Model for Sensor Communications Unit *1			
	NPN output	E9NC-AA10	E9NC-AA0	E9NC-VA10	E9NC-VA0
	PNP output	E9NC-AA40		E9NC-VA40	
connection method	Connector for Sensor Communications Unit Pre-wired (2 m)	Connector for Sensor Communications Unit	Connector for Sensor Communications Unit Pre-wired (2 m)	Connector for Sensor Communications Unit	
Output		1 output *2	2 outputs *3	1 output *2	2 outputs *3
Power supply voltage		24 VDC (20.4 to 26.4 V) class2 power is supplied from the connector via the communication unit.			
Power consumption		24 V power supply voltage in normal mode: 1,080 mW or less (consumption current 45 mA max.), eco-function ON: 840 mW or less (consumption current 35 mA max.), and eco-function LO: 960 mW or less (consumption current 40 mA max.)			
Sensor input range	Voltage range	4 to 20 mA DC		1 to 5 VDC	
	Input impedance	204 kΩ±1% (Input: no-insulated)			
Repeatability F.S./25°C		±0.2% F.S.			
Display accuracy F.S.		±0.5% F.S. ±2digit			
Temperature characteristics F.S.		±1% F.S.			
Control output		Load power supply voltage: 24 VDC (20.4 to 26.4 V) class2, open collector output type Load current: 100 mA max. for 1 to 3 units use, 20 mA max. for 4 or more units connected Residual voltage: Load current less than 10 mA: 1 V max., Load current 10 to 100 mA: 2 V max. Off-state current: 0.1 mA max.	Refer to the communication unit specifications	Load power supply voltage: 24 VDC (20.4 to 26.4 V) class2, open collector output type Load current: 100 mA max. for 1 to 3 units use, 20 mA max. for 4 or more units connected Residual voltage: Load current less than 10 mA: 1 V max., Load current 10 to 100 mA: 2 V max. Off-state current: 0.1 mA max.	Refer to the communication unit specifications
Response Time		1/10/100/500ms/1/10/30/60s (Initial value 500 ms)			
Indicator		Seven Segment Display (both sub and main digital display: white) OUT indicator (orange), NO/NC indicator (orange), ST indicator (blue), zero-reset indicator (green) OUT selective indicator (orange) (two lamps only)			
Protection circuit		Power supply reverse connection protection, output short-circuit protection, and output reverse connection protection	Power supply reverse connection protection, output short-circuit protection	Power supply reverse connection protection, output short-circuit protection, and output reverse connection protection	Power supply reverse connection protection, output short-circuit protection
Sensitivity adjustment		Smart Tuning (2-point tuning, full auto tuning, or percentage tuning (-99% to 99%)) or manual adjustment			
Maximum connectable Units		16 Units	Model E3NW-ECT *4, 30 units when used Model E3NW-CCL, 16 units when used	16 Units	Model E3NW-ECT *4, 30 units when used Model E3NW-CCL, 16 units when used
No. of Units for mutual interference prevention		None			
Functions	Operation mode	NO (Normal Open)/NC (Normal Close)			
	Zero Reset	Yes			
	Timer	Select from timer disabled, OFF delay, ON delay, or One-shot timer 1 ms to 9999 ms			
	Scaling	Set the upper/lower limits (-1999.9999 to 9999.9999, min. unit: 0.001)			
	Resetting settings *5	Select from initial reset (factory defaults) or user reset (saved settings).			
	Eco mode	Select from OFF (digital display lit), Eco ON (digital display not lit), and Eco LO (digital display dimmed).			
	Bank switching	Select from banks 1 to 4.			
	Output 1 Settings	Select from Normal detection mode or Wind comparator (area) detection mode.			
	Output 2 Settings	---	Select from Normal detection mode, Wind comparator (area) detection mode, and Error output mode.	---	Select from Normal detection mode, Wind comparator (area) detection mode, and Error output mode.
	Hysteresis width	Select from standard setting or user setting. For a user setting, the hysteresis width can be set from 0 to 9999.9999.			
	Display switch	Select from normal display, peak/bottom display, or CH number display (setting value display when adjusting the threshold)			
Key Lock	Yes				

E9NC-AA/VA

Item	Types	Current input		Voltage input	
		Model for Sensor Communications Unit *1			
	NPN output	E9NC-AA10	E9NC-AA0	E9NC-VA10	E9NC-VA0
	PNP output	E9NC-AA40		E9NC-VA40	
connection method	Connector for Sensor Communications Unit Pre-wired (2 m)	Connector for Sensor Communications Unit	Connector for Sensor Communications Unit Pre-wired (2 m)	Connector for Sensor Communications Unit	
Ambient temperature range and supply current for sensor head	Operating: Sensor consumption current 40 mA max. Groups of 1 or 2 Amplifier Units: 0 to 55°C, Groups of 3 to 10 Amplifier Units: 0 to 50°C, Groups of 11 to 16 Amplifier Units: 0 to 45°C, Groups of 17 to 30 Amplifier Units: 0 to 40°C *6 Sensor consumption current 100 mA max. 1 unit: 0 to 55°C, Groups of 2 to 7 Amplifier Units: 0 to 50°C, Groups of 8 to 12 Amplifier Units: 0 to 45°C Sensor consumption current 200 mA: 1 unit: 0 to 55°C, Groups of 2 to 5 Amplifier Units: 0 to 50°C Storage: -30 to +70°C (with no icing or condensation)				
Ambient humidity range	Operating and storage: 35% to 85% RH (with no condensation)				
Height	2,000 m max.				
Installation environment	Pollution level 3 (according to IEC60947-1)				
Insulation resistance	20 MΩ min. (at 500 VDC)				
Dielectric strength	1,000 VAC 50/60Hz 1min				
Vibration resistance	10 to 55 Hz with a 1.5-mm double amplitude for 2 hrs each in X, Y and Z directions				
Shock resistance	150 m/s ² for 3 times each in X, Y and Z directions				
Degree of protection (Sensor Head)	IEC60529 IP50				
Weight (packed state/sensor)	Approx. 95 g/Approx. 45 g	Approx. 65 g/Approx. 25 g	Approx. 95 g/Approx. 45 g	Approx. 65 g/Approx. 25 g	
Materials	Case	Polycarbonate (PC)			
	Cover	Polycarbonate (PC)			
	Code	Polyvinyl chloride (PVC)			
Accessories	Manual, 6-pin plug connector for connecting ECON cable (model XN2A-1670) x 1				

*1. The communication unit is compatible with EtherCAT type E3NW-ECT and E3NW-CCL of CC-Link. This unit is not usable with E3NW-CRT.

*2. Channel 1 of each amplifier unit is output as the output drawn by the cord.

*3. Output signals from two sensors are assigned to the PLC via the network. Various settings can be changed and detected values can be read by operating the PLC via the network.

*4. This is the case of connecting with OMRON NJ series. For details, refer to the communication unit manual.

*5. The bank is not reset by the user reset function or saved by the user save function.

*6. Only E9NC-VA0/AA0 is able to connect to between 17 and 30 units.

Engineering Data (Reference Value)

Analog Input Current/Voltage - Measured Value (Communication Data) Characteristics

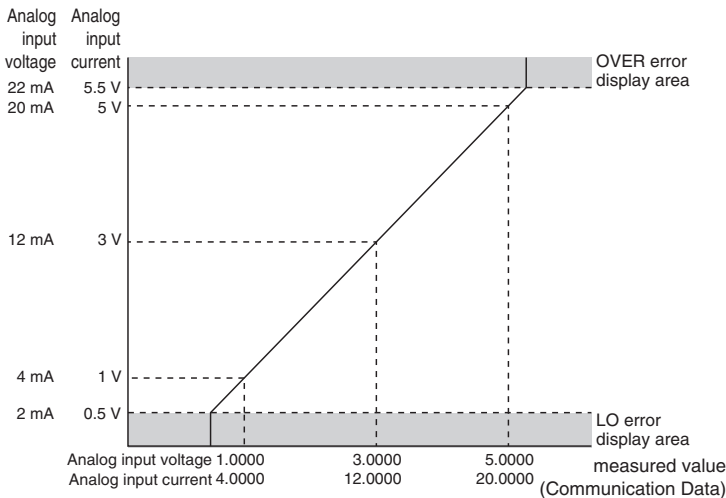

Error might occur in the range of the precision described Ratings and Specifications.
 The measured value (communication data) varies depending on the setup of the scaling function.

I/O Circuit Diagrams

NPN Output

Model	Operation mode	Timing chart	NO/NC indicator	Output circuit
E9NC-AA10 E9NC-VA10	NO (Normally open)	Sensing object: Yes (high), No (low) OUT indicator (orange): Lit (high), Not lit (low) Output transistor: ON (high), OFF (low) Load (e.g., relay): Operate (high), Reset (low) (Between 24 VDC and black leads)	NO lit.	
	NC (Normally closed)	Sensing object: Yes (low), No (high) OUT indicator (orange): Lit (low), Not lit (high) Output transistor: ON (low), OFF (high) Load (e.g., relay): Operate (low), Reset (high) (Between 24 VDC and black leads)	NC lit.	

PNP Output

Model	Operation mode	Timing chart	NO/NC indicator	Output circuit
E9NC-AA40 E9NC-VA40	NO (Normally open)	Sensing object: Yes (high), No (low) OUT indicator (orange): Lit (high), Not lit (low) Output transistor: ON (high), OFF (low) Load (e.g., relay): Operate (high), Reset (low) (Between 0 VDC and black leads)	NO lit.	
	NC (Normally closed)	Sensing object: Yes (low), No (high) OUT indicator (orange): Lit (low), Not lit (high) Output transistor: ON (low), OFF (high) Load (e.g., relay): Operate (low), Reset (high) (Between 0 VDC and black leads)	NC lit.	

Sensor Head Wiring

Pin arrangement

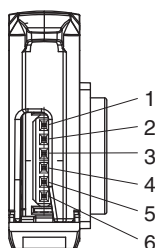

Terminal No.	Signal Name	I/O	Signal
1	Vcc	O	Sensor power supply (24 V)
2	GND	O	Sensor power supply (0 V)
3	---	---	---
4	---	---	---
5	---	---	---
6	A IN	I	Analog input

Note: Use XN2A-1670 as the sensor-side connector for connecting amplifier units. Refer to your OMRON website for details.

E9NC-AA/VA

Nomenclature

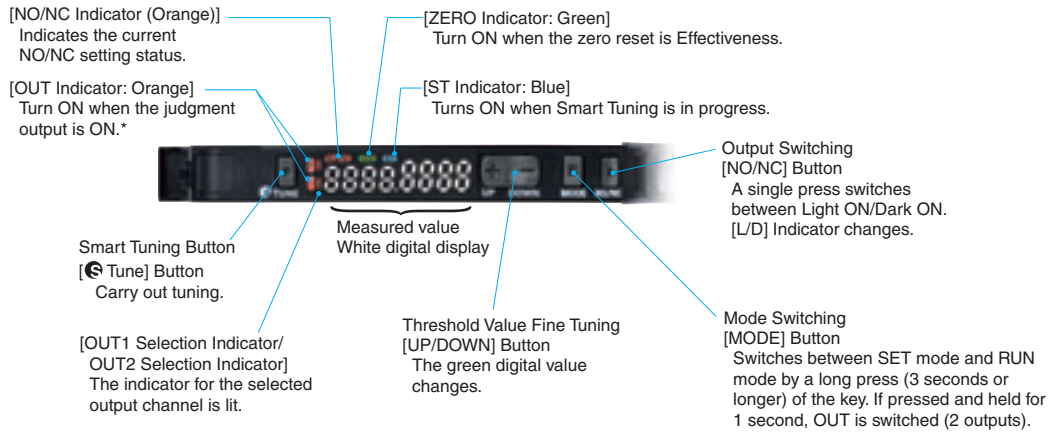

* Only OUT1 turns ON for output.



Safety Precautions





Be sure to read the precautions for all models in the website at: <http://www.ia.omron.com/>.

Warning Indications

 WARNING	Warning level Indicates a potentially hazardous situation which, if not avoided, will result in minor or moderate injury, or may result in serious injury or death. Additionally, there may be significant property damage.
Precautions for Safe Use	Supplementary comments on what to do or avoid doing, to use the product safely.
Precautions for Correct Use	Supplementary comments on what to do or avoid doing, to prevent failure to operate, malfunction or undesirable effect on product performance.

Meaning of Product Safety Symbols

	General prohibition Indicates the instructions of unspecified prohibited action.
	Caution, explosion Indicates the possibility of explosion under specific conditions.
	Caution, fire Indicates the possibility of fire under specific conditions.

 WARNING	
<p>This product is not designed or rated for ensuring safety of persons either directly or indirectly. Do not use it for such purposes.</p>	
<p>Do not use the product with voltage in excess of the rated voltage. Excess voltage may result in malfunction or fire.</p>	
<p>Never use the product with an AC power supply. Otherwise, explosion may result.</p>	

Precautions for Safe Use

The following precautions must be observed to ensure safe operation of the product. Doing so may cause damage or fire.

- Do not install the product in the following locations.
 - (1) Locations subject to direct sunlight
 - (2) Locations subject to condensation due to high humidity
 - (3) Locations subject to corrosive gas
 - (4) Locations subject to vibration or mechanical shocks exceeding the rated values
 - (5) Locations subject to exposure to water, oil, chemicals
 - (6) Locations subject to steam
 - (7) Locations subject to strong magnetic field or electric field
- Do not use the product in environments subject to flammable or explosive gases.
- Do not use the product in any atmosphere or environment that exceeds the ratings.
- To secure the safety of operation and maintenance, do not install the product close to high-voltage devices and power devices.
- High-voltage lines and power lines must be wired separately from the product. Wiring them together or placing them in the same duct may cause induction, resulting in malfunction or damage.
- Do not apply any load exceeding the ratings. Doing so may cause damage or fire.
- Do not short the load. Doing so may cause damage or fire.

- Connect the load correctly.
- Do not miswire such as the polarity of the power supply.
- Do not use the product if the case is damaged.
- Burn injury may occur. The product surface temperature rises depending on application conditions, such as the ambient temperature and the power supply voltage. Attention must be paid during operation or cleaning.
- When setting the sensor, be sure to check safety such as by stopping the equipment.
- Be sure to turn off the power supply before connecting or disconnecting wires.
- Do not attempt to disassemble, repair, or modify the product in any way.
- When disposing of the product, treat it as industrial waste.
- Do not use the Sensor in water, rain, or outdoors.
- Process the unwired terminals so as not to contact other wiring or devices.
- Connect the Sensor Head correctly. Otherwise, it might be broken or catch fire.
- Do not connect any sensor heads differently designed from the amplifier input specification (voltage/current range and current consumption). Otherwise, it might be broken or catch fire.
- To use this device as connecting with each other, be sure to connect with the same power supply and turn ON the power simultaneously.
Using a separate power supply will influence the functions when connecting the devices to use them.
- The maximum number of connectable amplifiers is different depending on the current consumption of the sensor head. The number of the amplifiers connected must be within the specified limit. Otherwise, they might be broken or catch fire.
- If power is supplied from an external power source to the sensor, excessive current flows to this product or sensor, so that the device might be broken or catch fire. Use this product as supplying power from it to the sensor.
- When connecting this device with a sensor, confirm product performance well before using the product.
- UL Standard Certification
Only the sensors with Enhanced UL Certification Mark are certified by UL. They are intended to be supplied by a "Class 2 circuit". When used in United States and Canada, Please use the same Class 2 source for input and output. The overcurrent protection current rating is 2 A max. They were evaluated as Open type and shall be installed within a enclosure.

Precautions for Correct Use

- Be sure to mount the unit to the DIN track until it clicks.
- When using a connector type product, place a protective label on the power supply connecting terminals that are not used, to prevent electric shock or short circuit.

Amplifier Unit with Connector for Communications Unit

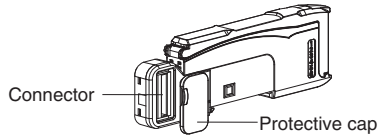

- The length for the cable extension must be 30 m or less. Be sure to use a cable of at least 0.3 mm² for extension.
- Do not apply the forces on the cord exceeding the following limits: Pull: 40 N; torque: 0.1 N·m; pressure: 20 N; bending: 29.4 N
- Always keep the protective cover in place when using the product. Not doing so may cause malfunction.
- It may take time until the measurement value become stable immediately after the power is turned on depending on use environment.
- The Mobile Console E3X-MC11, E3X-MC11-SV2 and E3XMC11-S cannot be connected.
- The Communication Unit E3X-DRT21-S, E3X-CRT and E3X-ECT cannot be connected.
- If you notice an abnormal condition such as a strange odor, extreme heating of the unit, or smoke, immediately stop using the product, turn off the power, and consult your dealer.
- Do not use thinner, benzine, acetone, and lamp oil for cleaning.
- When using Sensor Heads with free-cut cables, be sure to check the performance and resistance to electronic noise before use for the cable length between Preamplifiers and Amplifier Units.

Mounting the Amplifier Units

Mounting on DIN Track

1. Let the hook on the Amplifier Unit's Fiber Unit connection side catch the track.
 2. Push the unit until the hook clicks into place.
- Note:** DIN track (PFP-□N) is sold separately.

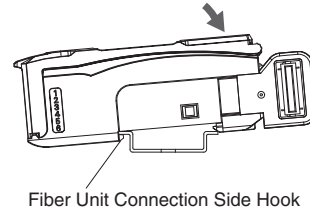

Removing from DIN Track

1. Push the unit in the direction 1.
2. Lift the unit in the direction of arrow 2 while performing step (1).

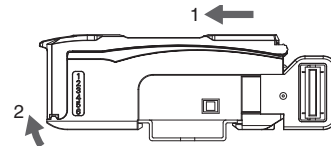

Joining Amplifier Units

1. Mount the Amplifier Units one at a time onto the DIN track.
2. Slide the Amplifier Unit until the Amplifier Unit is closely attached. (Arrow 3)
3. Use End Plates (PFP-M: separately sold) at the both ends of the grouped Amplifier Units to prevent them from separating due to vibration or other cause. (Arrow 4)
4. Tighten the screw on the End Plates using a driver. (Arrow 5)

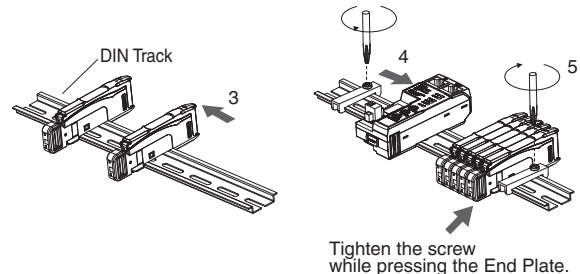

If the Sensor Communications Unit is equipped with a cable, apply the separately sold end plate (E39-EP1) to tighten the screws of it with a screwdriver (Arrow 6).

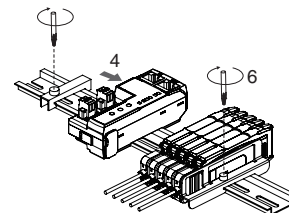

- Note:**
1. If there is any vibration, use the end plate even for the single body of the Amplifier Unit.
 2. To install this device without connecting with the Amplifier Unit, seal the optical communication part on the side with light shielding tape.

Dimensions

Amplifier Units

E9NC-AA0/-VA0

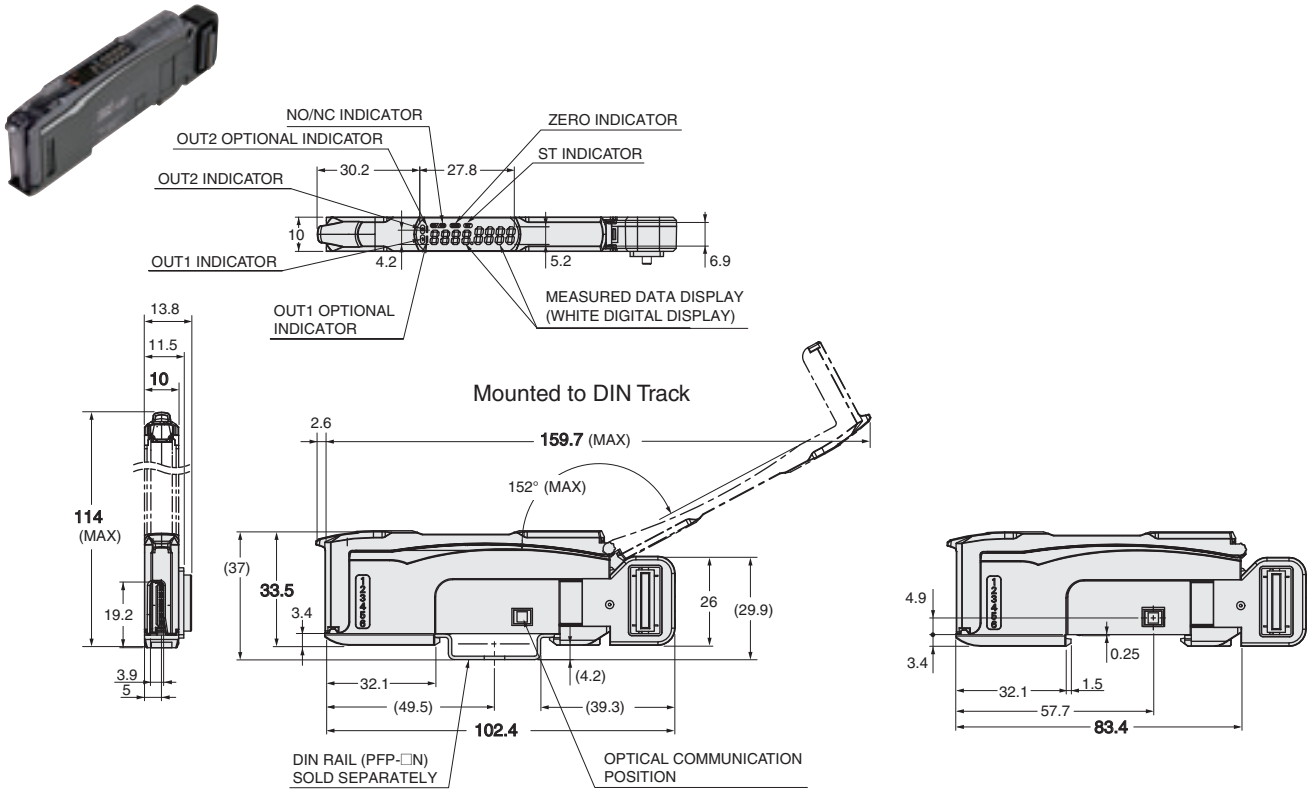

E9NC-AA10/-AA40/-VA10/-VA40

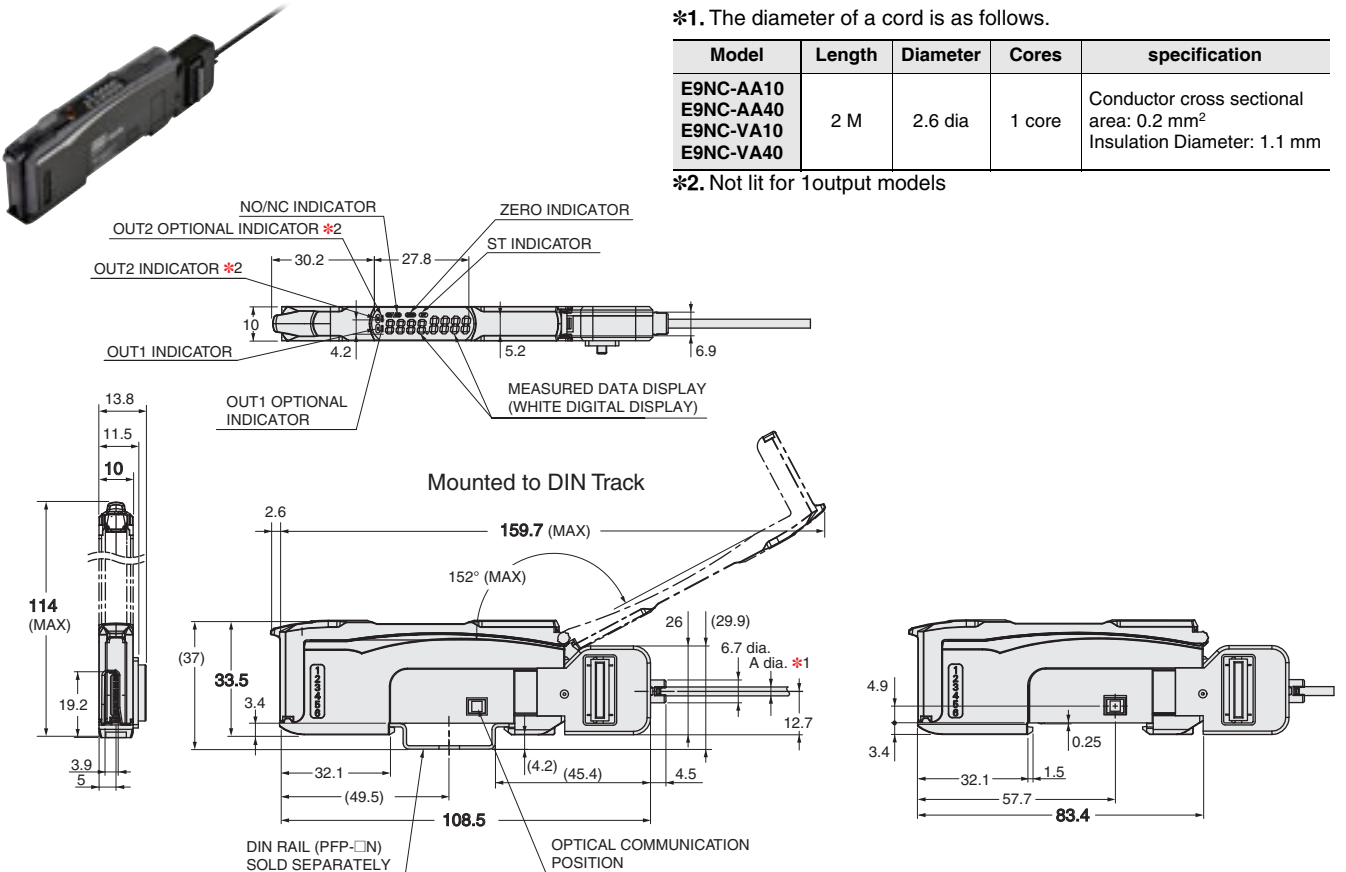

*1. The diameter of a cord is as follows.

Model	Length	Diameter	Cores	specification
E9NC-AA10 E9NC-AA40 E9NC-VA10 E9NC-VA40	2 M	2.6 dia	1 core	Conductor cross sectional area: 0.2 mm ² Insulation Diameter: 1.1 mm

*2. Not lit for 1output models

E9NC-AA/VA

DIN Track

PFP-100N
PFP-50N

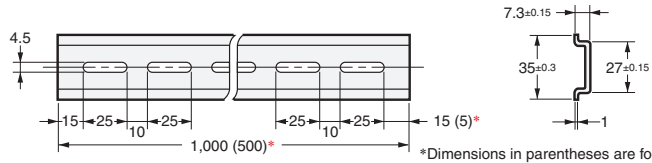

Material: Aluminum

PFP-100N2

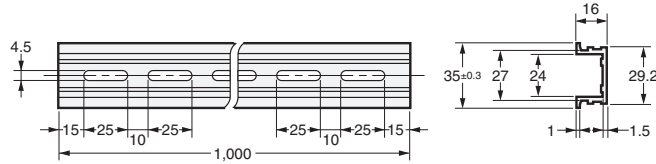

Material: Aluminum

End Plate

PFP-M

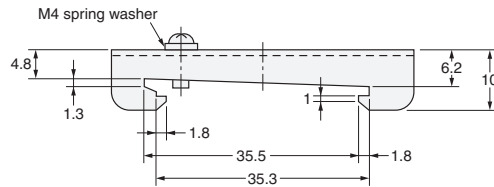
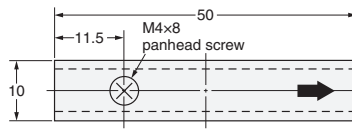
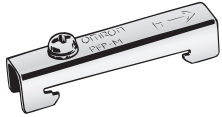

Materials: Iron, zinc plating

End Plate

E39-EP1



Materials: SUS304 CP

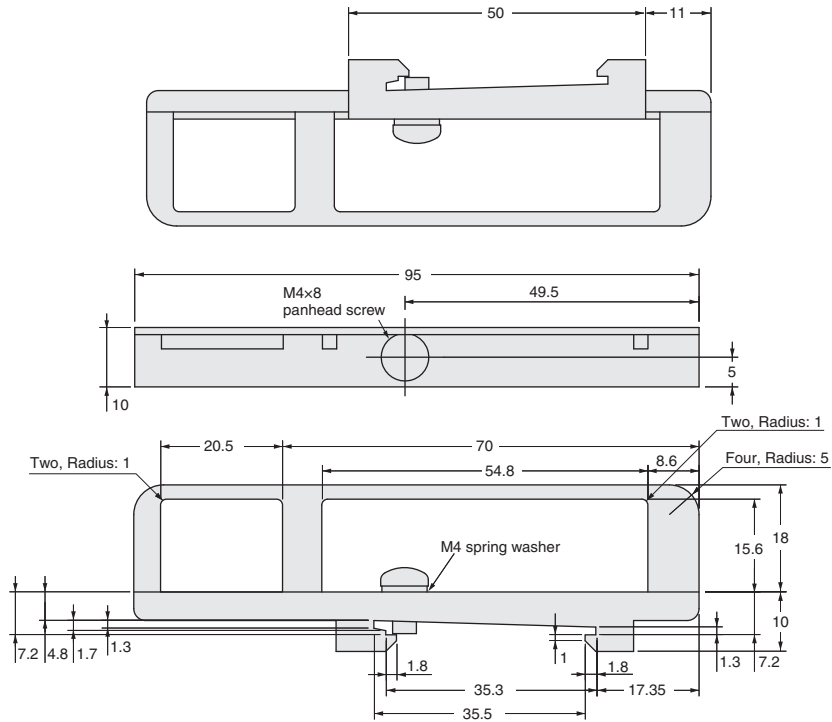

Terms and Conditions Agreement

Read and understand this catalog.

Please read and understand this catalog before purchasing the products. Please consult your OMRON representative if you have any questions or comments.

Warranties.

(a) Exclusive Warranty. Omron's exclusive warranty is that the Products will be free from defects in materials and workmanship for a period of twelve months from the date of sale by Omron (or such other period expressed in writing by Omron). Omron disclaims all other warranties, express or implied.

(b) Limitations. OMRON MAKES NO WARRANTY OR REPRESENTATION, EXPRESS OR IMPLIED, ABOUT NON-INFRINGEMENT, MERCHANTABILITY OR FITNESS FOR A PARTICULAR PURPOSE OF THE PRODUCTS. BUYER ACKNOWLEDGES THAT IT ALONE HAS DETERMINED THAT THE PRODUCTS WILL SUITABLY MEET THE REQUIREMENTS OF THEIR INTENDED USE.

Omron further disclaims all warranties and responsibility of any type for claims or expenses based on infringement by the Products or otherwise of any intellectual property right. (c) Buyer Remedy. Omron's sole obligation hereunder shall be, at Omron's election, to (i) replace (in the form originally shipped with Buyer responsible for labor charges for removal or replacement thereof) the non-complying Product, (ii) repair the non-complying Product, or (iii) repay or credit Buyer an amount equal to the purchase price of the non-complying Product; provided that in no event shall Omron be responsible for warranty, repair, indemnity or any other claims or expenses regarding the Products unless Omron's analysis confirms that the Products were properly handled, stored, installed and maintained and not subject to contamination, abuse, misuse or inappropriate modification. Return of any Products by Buyer must be approved in writing by Omron before shipment. Omron Companies shall not be liable for the suitability or unsuitability or the results from the use of Products in combination with any electrical or electronic components, circuits, system assemblies or any other materials or substances or environments. Any advice, recommendations or information given orally or in writing, are not to be construed as an amendment or addition to the above warranty.

See <http://www.omron.com/global/> or contact your Omron representative for published information.

Limitation on Liability; Etc.

OMRON COMPANIES SHALL NOT BE LIABLE FOR SPECIAL, INDIRECT, INCIDENTAL, OR CONSEQUENTIAL DAMAGES, LOSS OF PROFITS OR PRODUCTION OR COMMERCIAL LOSS IN ANY WAY CONNECTED WITH THE PRODUCTS, WHETHER SUCH CLAIM IS BASED IN CONTRACT, WARRANTY, NEGLIGENCE OR STRICT LIABILITY.

Further, in no event shall liability of Omron Companies exceed the individual price of the Product on which liability is asserted.

Suitability of Use.

Omron Companies shall not be responsible for conformity with any standards, codes or regulations which apply to the combination of the Product in the Buyer's application or use of the Product. At Buyer's request, Omron will provide applicable third party certification documents identifying ratings and limitations of use which apply to the Product. This information by itself is not sufficient for a complete determination of the suitability of the Product in combination with the end product, machine, system, or other application or use. Buyer shall be solely responsible for determining appropriateness of the particular Product with respect to Buyer's application, product or system. Buyer shall take application responsibility in all cases.

NEVER USE THE PRODUCT FOR AN APPLICATION INVOLVING SERIOUS RISK TO LIFE OR PROPERTY OR IN LARGE QUANTITIES WITHOUT ENSURING THAT THE SYSTEM AS A WHOLE HAS BEEN DESIGNED TO ADDRESS THE RISKS, AND THAT THE OMRON PRODUCT(S) IS PROPERLY RATED AND INSTALLED FOR THE INTENDED USE WITHIN THE OVERALL EQUIPMENT OR SYSTEM.

Programmable Products.

Omron Companies shall not be responsible for the user's programming of a programmable Product, or any consequence thereof.

Performance Data.

Data presented in Omron Company websites, catalogs and other materials is provided as a guide for the user in determining suitability and does not constitute a warranty. It may represent the result of Omron's test conditions, and the user must correlate it to actual application requirements. Actual performance is subject to the Omron's Warranty and Limitations of Liability.

Change in Specifications.

Product specifications and accessories may be changed at any time based on improvements and other reasons. It is our practice to change part numbers when published ratings or features are changed, or when significant construction changes are made. However, some specifications of the Product may be changed without any notice. When in doubt, special part numbers may be assigned to fix or establish key specifications for your application. Please consult with your Omron's representative at any time to confirm actual specifications of purchased Product.

Errors and Omissions.

Information presented by Omron Companies has been checked and is believed to be accurate; however, no responsibility is assumed for clerical, typographical or proofreading errors or omissions.

OMRON Corporation Industrial Automation Company
Kyoto, JAPAN

Contact: www.ia.omron.com

Regional Headquarters

OMRON EUROPE B.V.

Wegalaan 67-69, 2132 JD Hoofddorp
The Netherlands
Tel: (31)2356-81-300/Fax: (31)2356-81-388

OMRON ELECTRONICS LLC

2895 Greenspoint Parkway, Suite 200
Hoffman Estates, IL 60169 U.S.A.
Tel: (1) 847-843-7900/Fax: (1) 847-843-7787

OMRON ASIA PACIFIC PTE. LTD.

No. 438A Alexandra Road # 05-05/08 (Lobby 2),
Alexandra Technopark,
Singapore 119967
Tel: (65) 6835-3011/Fax: (65) 6835-2711

OMRON (CHINA) CO., LTD.

Room 2211, Bank of China Tower,
200 Yin Cheng Zhong Road,
PuDong New Area, Shanghai, 200120, China
Tel: (86) 21-5037-2222/Fax: (86) 21-5037-2200

Authorized Distributor:

© OMRON Corporation 2018-2021 All Rights Reserved.
In the interest of product improvement,
specifications are subject to change without notice.

CSM_2_1
Cat. No. **E474-E1-02**

0221 (0918)