

New-generation environmental sensor

EQUO™ Series

Portable Power Monitor

ZN-CTX21 (Logging unit)

ZN-CTM (Dedicated CT unit)

Power Sensor Station

ZN-KMX21

OMRON

Easy and Quick "Checking Power" at the Worksite

Whenever needed, you can identify the level of electricity consumption immediately at your worksite.



realizing

Now this Clamp Type
is available ▶

**Do you have
the concerns
about power
measurement?**

**I do not want to
stop the machine
to just check
power.**

**It's troublesome
to install the
measuring equipment,
when you want to
check power.**

**It takes time to
collect data.**

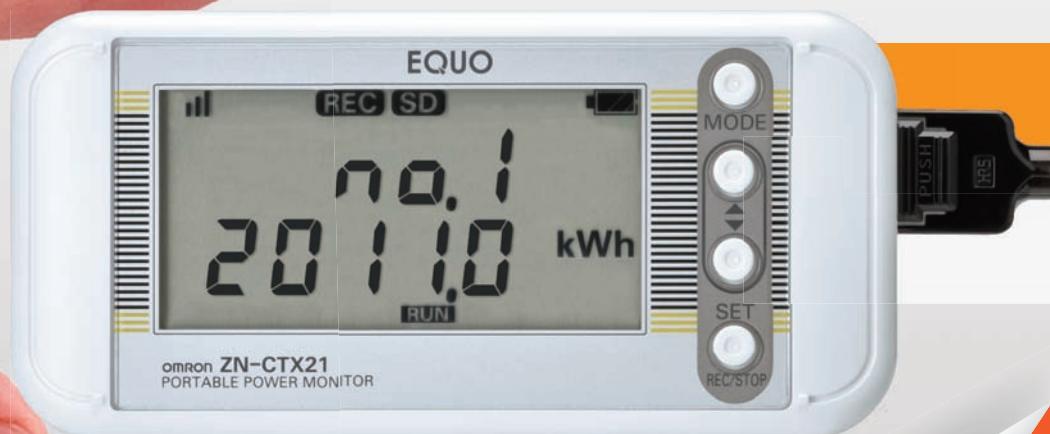

Logging unit (actual size)

**For more
information**

Power is indicated based on CT(current)

What you do is just connecting CT.
There is no need for wiring for voltage measurement.

Battery-powered, Fixed by Magnet and Ultra-thin

External power source is not necessary.
Easy to mount with the attached magnet.

Ultra-easy Way of Logging Electricity

Logging starts with one push of a button.

Debut of a Portable Power Monitor Smart and Easy to use!

This Monitor easily solves troubles for measuring power!



Split type CT



Clamp type CT

This single unit solves all the problems you have with power checking at your

You can rely on it for your energy saving activity.

Many of the currently used power meters are not suitable for easily measuring power of a variety of machines and distribution boards. As a result, the electric power of a great number of machines in worksites is left unmeasured. Our Portable Power Monitor ZN-CTX21 solves such problems. It is the industry's first "portable power monitor for energy-saving activities at the worksite."

It is "usable for anyone" "with ease" and indicates measurements "on site" immediately.

This new concept-based Portable Power Monitor ZN-CTX21 will make a great contribution to energy-saving activities at the worksite.

**Just setting the CT completes the preparation.
Electrical power equivalent is calculated on a real-time basis.***

There is no need to stop machines and production lines.



There is no need to stop the power supply.

Current value (measured value)



Electric Power value (equivalent value)



Automatically calculated into electrical power equivalent.

* Since electricity is calculated based on current value alone, a certain margin of error may result when fluctuations are present in voltage and power factors.

Compact design with the battery-powered.

It is installable anywhere.



It works for a week on the battery.*



It can be installed inside the distribution board using the magnet.



* In sleep mode, battery life depends on the measurement environment as well as the type and performance of the given battery.
Note: A manganese battery is not usable.

Easy logging and quick display

It takes hardly any time to collect data.

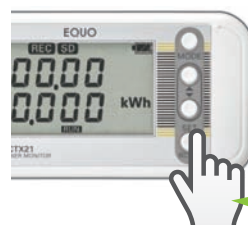

Necessary data alone are logged

Push the button for 3 seconds!



Ranking can be displayed.

worksite!

LAN port

Data logging through networks is available. Setting of the monitor is also possible.

DC cable

DC cable is available for long hours logging.



SD card slot

You can easily collect logged data by using SD card.

Alarm output terminal

Alarms when an error occurs.

Six Types of Dedicated CT units for Various Applications

The clamp type CT provides easy measurement in locations that are difficult for CTs of other types.

Clamp type CT is detachable with the single touch of a button.



ZN-CTS51-200A
Measurement range: 1.2 to 240 A
CT inside diameter: 23 dia.

Downsized and less expensive split type CT



ZN-CTS11-5A Measurement range: 0.03 to 6 A CT internal diameter: 7.9mm dia.	ZN-CTS11-50A Measurement range: 0.3 to 60 A CT internal diameter: 9.5mm dia.	ZN-CTS11-100A Measurement range: 0.6 to 120 A CT internal diameter: 14.5mm dia.	ZN-CTS11-200A Measurement range: 1.2 to 240 A CT internal diameter: 24.0mm dia.	ZN-CTS11-400A Measurement range: 2.4 to 480 A CT internal diameter: 35.5mm dia.
---	--	---	---	---

Refer to the List of specifications on applicable cable diameter.
Accuracy of ZN-KMX21 is $\pm 2.0\%FS \pm 1$ digit (Ambient temperature 23°C, rated input, rated frequency) *1
*1: An error of the dedicated CT is not included.

Power Consumption Checkup covers Devices to Distribution Boards

Changing the number of CTs connected to the branch cable enables measurement of single-phase 3-wire, three-phase 3-wire (unbalanced voltages in three-phase system) and three-phase 4-wire, too.

Checkup of electricity on distribution boards is also supported.

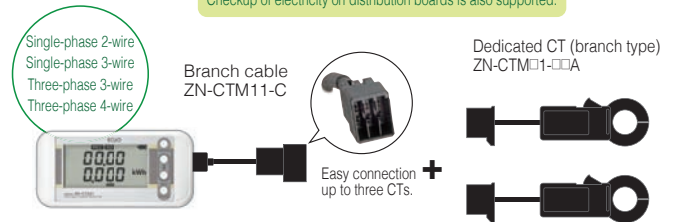

* Up to three CTs are connectable.

Checkup at the Time and Behavior to Watch Out for

Display of cumulative electric power (equivalent value)

When logging is started, the upper space displays the time and the lower space displays cumulative electric power (equivalent value). In this way, you can check electric power used from the start to the end of logging. You can set the logging conditions not only from the buttons but also by specifying the starting time or elapsed time.

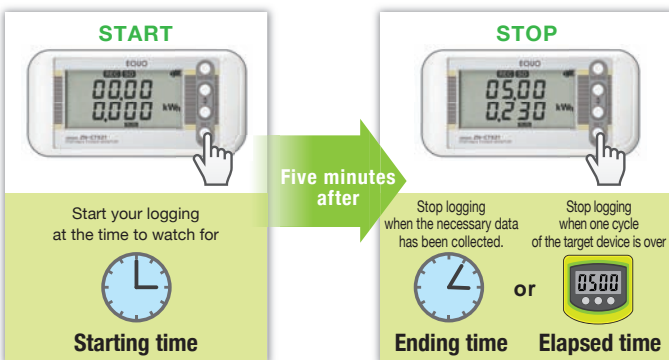

Standby Electricity is also not Overlooked

Automatic range selection function

Our product is capable of measuring minute electric current that has been immeasurable by existing models. This feature enables you to check electricity consumption of a machine on standby.

When the range is fixed (previous model)

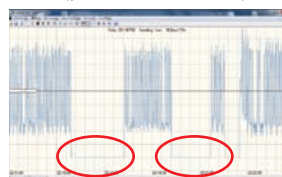

Current on standby is not measured and indicated as zero.

When automatic range selection is enabled

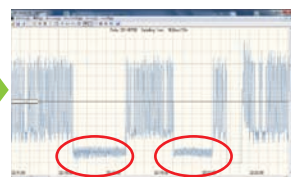

Standby electricity is not overlooked!

Note: If a measurement value becomes 5% or less than the rated current, the minute range is selected.

Helpful for these cases

Simple and Convenient Check of Power

Example of use I need to know which machine consumes electricity most!

Normal cumulative mode

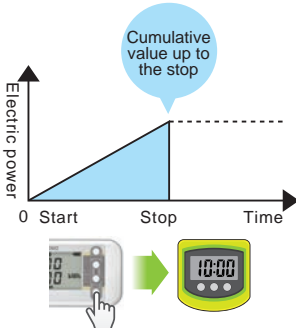

The portable power monitor displays the cumulative electric power from the start to stop times producing records during this period as a single piece of data.

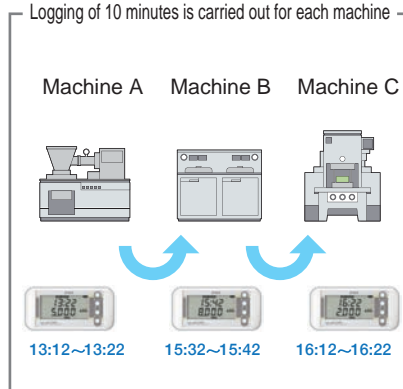

Machine B consumes the most!

Data is ranked in descending order of cumulative electric power.

Ranking	Time zone	Screen display
No.1	Machine B	no.1 15:32 no.1 8kWh
No.2	Machine A	no.2 13:12 no.2 5kWh
No.3	Machine C	no.3 16:12 no.3 2kWh

Example of use I need to know in which time zone electricity is consumed most!

Accumulation reset mode

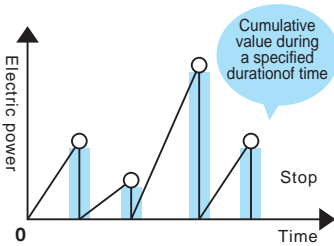

Cumulative value during a specified duration of time (30 minutes, 1 hour or 24 hours) is finalized. The portable power monitor displays the cumulative electric power during a period of time as a single piece of data. (Example: If you specify 30 minutes for the duration and continue logging for 24 hours, you will get 48 pieces of data.)



Energy consumption from 8:00 to 9:00 is the most.

Data is ranked in descending order of cumulative electric power.

Ranking	Time zone	Screen display
No.1	8:00-9:00	no.1 08:00 no.1 32kWh
No.2	9:00-10:00	no.2 09:00 no.2 18kWh
No.3	14:00-15:00	no.3 14:00 no.3 12kWh

Example of use I need energy-saving measures for a machine of high-speed operation (Several seconds for 1 cycle of operation).

High-speed logging mode

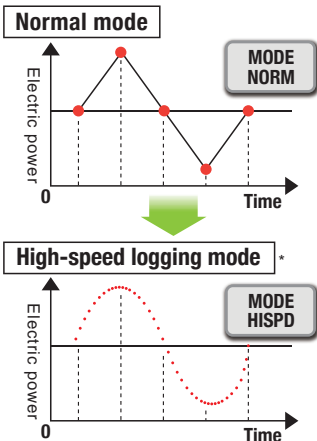

The high-speed mode logs data every 100ms*.
* Data logging at 60 Hz completes in 83 ms and 100 ms at 50 Hz.

Application example for a molding machine

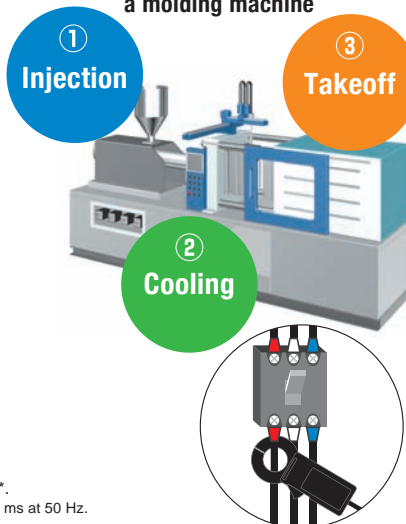

State of the machine is checked by its waveforms!

This mode shows the power-consuming device states, which were invisible in normal mode.

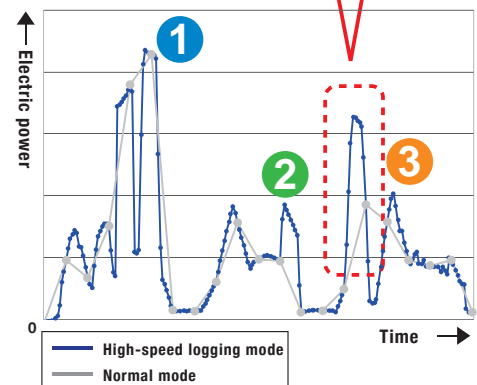

Logged Data can be shown in a Graph immediately with the PC Software.

Step1

Logged data is collected with an SD card and read to a PC.

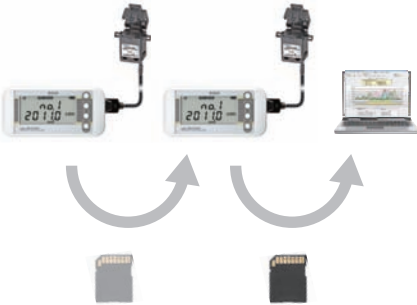

Step2

Start the software and select the desired folder. The software identifies the data type and displays the data on the screen.

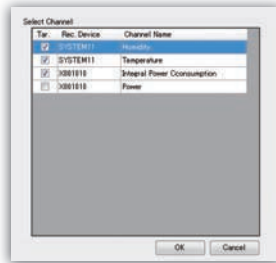

Step3

Select the data you want to display and graphic representation of the data is readily available.

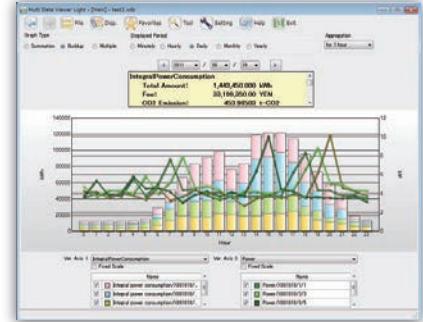

Two Software Programs for Use in a Manufacturing Setting are bundled.

Multi Data Viewer For checking the current use of electricity

This software is suitable for displaying power consumption for a certain time unit such as 1 minute, 1 hour and 24 hours. Its bar-graph representation is best suited for indicating cumulative electric power.

You can change the display period with the one click.



Check boxes are for you to display only the data you want to view.

A buildup display helps identify a machine, time slot, day, etc. that consumes more power at a glance.

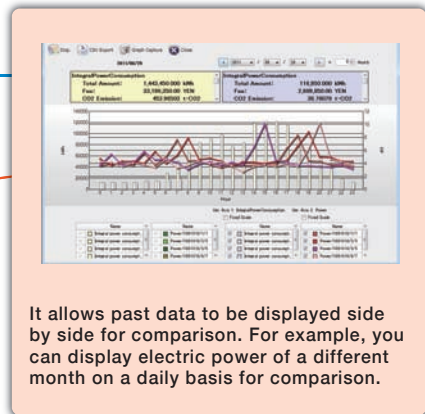

It allows past data to be displayed side by side for comparison. For example, you can display electric power of a different month on a daily basis for comparison.

An overlap display shows at a glance the change before and after the improvement.

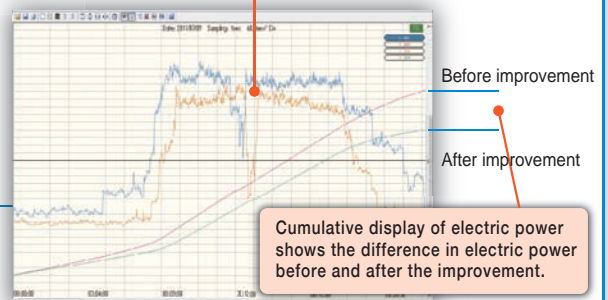

Cumulative display of electric power shows the difference in electric power before and after the improvement.

SD Viewer For analysis of electricity on a second basis

This software is suitable for displaying changes in instantaneous power such as data being logged on a second basis.

The display is freely changeable depending on the length of 1 cycle of the target of measurement.

Our Further Proposals on Power Checkup

Strong Support for Construction of a Monitoring System

Power Sensor Station ZN-KMX21

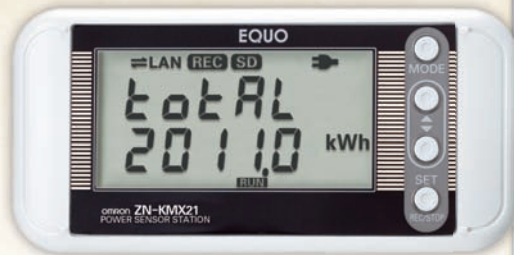

For monitoring of the power of an entire building

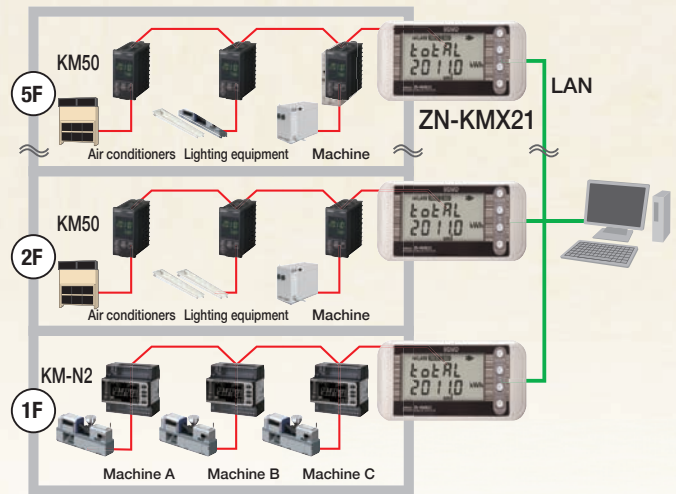

A single button operation logs, in block, the data on 31 KM series units.

Data on 31 units of KM series for electric power monitoring can be logged, in block to the SD card.

The PC software easily enables graphic representation of the saved data.

The same software as that for the Portable Power Monitor ZN-CTX21 is available. It provides graphic representation of the data saved on the SD card and PC with ease.

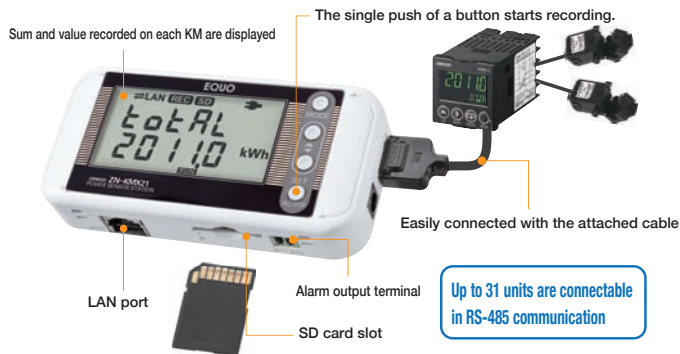

NOTE: To directly connect KM-N1-FLK, KM-N2-FLK and KM-N3-FLK to the product, please purchase a separately sold dedicated connection cable ZN9-KMC30-N.

You can set the connected KMs at a time by use of the special tool.

Dedicated software Easy KM Manager for KM series is used for setting KMs.
NOTE 1: Operation is guaranteed only for functionality related to "Unit setting".
NOTE 2: The Easy KM Manager does not support the KM-N1-FLK, KM-N2-FLK, and KM-N3-FLK.

Energy-saving Supporting Equipment for Monitoring System

Compact Power Sensor

KM-N2-FLK



- Large Easy-to-read Displays
- Many Host Communications Methods
- Multi-address System

Smart Power Monitor

KM50-C1-FLK
KM50-E1-FLK



- Measurement on the primary side of the inverter
- Measurement of minute electricity
- Pulse count for production and flow rate

Sensor Network Server

EQ100-E



- Various sensors such as electricity, air flow rate, pulse, analog, temperature/humidity, particles can be connected.
- Number of connectable sensors: 224 units (LAN: 100 units/RS-485: 124 units)

Quality



Energy

visualize Extra Energy

Temperature and humidity



Thermo-Humidity Station

Minute differential pressure



Differential Pressure Station

Particles



Air particle sensor, Particle measurement type / Air particle sensor, Dust measurement type

Electric power



Portable Power Monitor ZN-CTX21

Power Sensor Station ZN-KMX21

Environmental Visualization Software **OPTION** Wave Inspire ES ZN-SW11-S

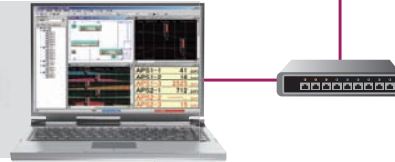

This software is recommended for real-time display (monitoring) of waveforms.

Environmental information + Electric power are displayed in synchronization on a real-time basis

For example, this software synchronizes "cleanliness (environmental information)" and "electric power for a clean room" in the display on a real-time basis.

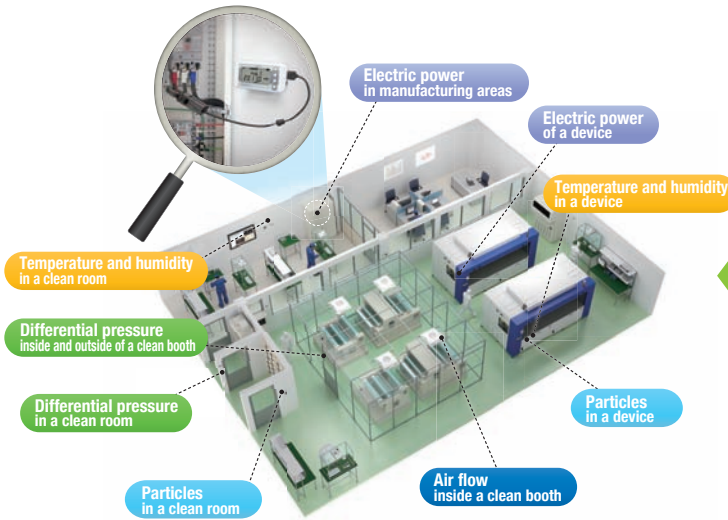

It displays environmental information and electric power on a layout drawing in a manner that enables you to understand them at a glance.

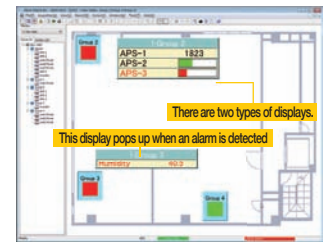
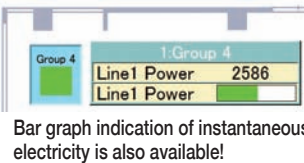

Real-time monitoring on the map display is also available

This software supports linkage with various software products in the marketplace.

Thanks to the automatic transfer function in Excel and the mail transmission function when an alarm is generated, data administration and monitoring of a worksite are made easier.

Visualization of Extra Energy, a Blind Side in Energy Saving

For example, displaying "cleanliness" and "electric power of an air conditioner" synchronously and at the same time, you can identify excess energy in relation to the given quality control standard. Then, improving operation and enhancing control allows you to reduce extra energy while maintaining an optimum quality level. And since both quality and energy are visualized, the influence to the quality and the effect of electric-energy cut down is obvious.

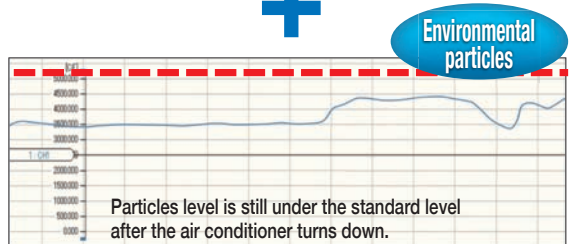
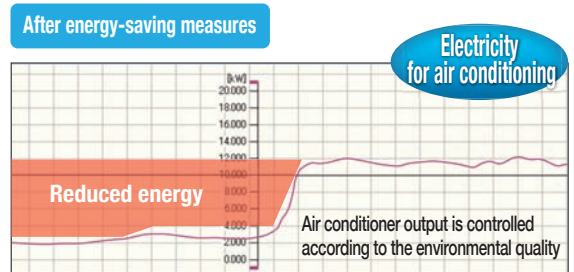
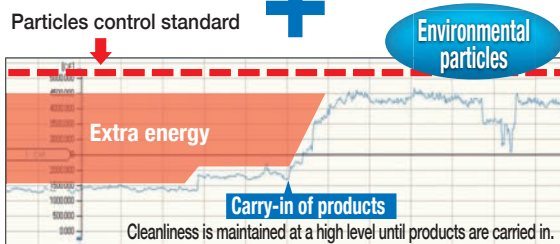
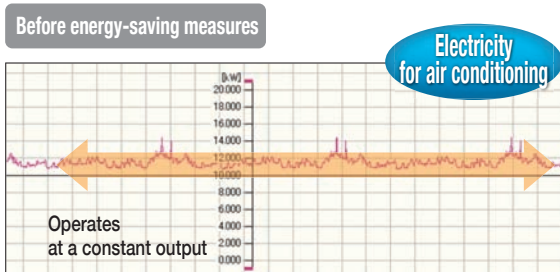

List of specifications

Portable Power Monitor







Ordering Information

■ Logging unit

Appearance	Product name	Model	Power supply
	Logging unit	ZN-CTX21-A	Battery/DC cable

■ Dedicated CT unit

Branch type

Appearance	Product name	Model
	Branch cable (cable length 1.3 m)	ZN-CTM11-C
	Split type CT Connector: For connecting the branch cable Cable length: 0.2 m	ZN-CTM11-5A
		ZN-CTM11-50A
		ZN-CTM11-100A
		ZN-CTM11-200A
	Clamp type CT Connector: For connecting the branch cable Cable length: 0.2 m	ZN-CTM11-400A
		ZN-CTM51-200A

Guideline for selecting dedicated CT unit

Model	Branch cable Model ZN-CTM11-C	CT exclusive for branch type Model ZN-CTM-A (*)
Applicable circuits		
Single-phase 2-wire	1	1
Single-phase 3-wire	1	2
Three-phase 3-wire	1	2
Three-phase 4-wire	1	3

* Up to three dedicated CTs for branch type are connectable to the branch cable. Be sure, however, not to connect a CT of different rated current. Correct measurement will be blocked. (Necessary quantity is indicated in the table)

■ Dedicated CT unit (rating and performance)

Item	Model	ZN-CTM11-5A	ZN-CTM11-50A	ZN-CTM11-100A	ZN-CTM11-200A	ZN-CTM11-400A ZN-CTM11-400A	ZN-CTM51-200A
Primary side rated current		5 A	50 A	100 A	200 A	400 A	200 A
Secondary winding		3,000 turns				6,000 turns	3,000 turns
Applicable frequency		10 Hz to 5 kHz					
Insulation resistance		Between output terminal and case: 50 MΩ minimum (500 VDC megohms)					
Withstand voltage		Between output terminal and case: 2,000 VAC 1 minute					
Protection element		7.5 V clamp element					
Allowable frequency of disconnection		100 times					5,000 times
Applicable wire diameter *		7.9 mm dia. maximum	9.5 mm dia. maximum	14.5 mm dia. maximum	24.0 mm dia. maximum	35.5 mm dia. maximum	23.0 mm dia. maximum
Operating temperature and humidity range		-20°C to +60°C 85% maximum (no condensation or icing)					
Storage temperature and humidity range		-30°C to +65°C 85% maximum (no condensation or icing)					
Voltage of circuit used		480 VAC maximum					

* If you use a flat cable, select the cable based on the dimensions of the CT.

Power Sensor Station

Ordering Information

■ Station unit

Appearance	Product name	Model	Power supply
	Station unit	ZN-KMX21-A	DC cable

Rating and performance

■ Station unit

Item	Model	ZN-KMX21-A
Connectable Power Sensor/Monitor		KM50-C/E, KM100, KM20-B40-FLK, KM-N1-FLK, KM-N2-FLK, KM-N3-FLK
Max. Number of Connectable Power Sensor/Monitor Units		31 units
Display		7-seg. 5-digit 2-step LCD display, auxiliary information indicator displays
Recording Interval		1 s, 2 s, 5 s, 10 s, 20 s, 30 s, 1 min.
Recorded data		Momentary power, Integrated power, Power factor, Sum of pulse input counts 1 and 2 *1
Operation Function		Integrated power total sum, integrated momentary power, electricity rate total sum
Recording Mode		Continue mode*2, Ring mode *3
External Output		Alarm output (Photocoupler output) *4
Memory Capacity (Internal)		Internal memory: approx. 200 data items (at maximum load); approx. 6800 data items *5 (at minimum load)
Memory Capacity (External)		SD card (measured value and converted value saving/set value saving and reading), Recommended SD card: HMC-SD292 (2 GB) and HMC-SD492 (4 GB) (manufactured by OMRON) *6
Power Supply		DC input: 24 VDC±10%

Rating and performance

■ Logging unit (rating)

Item	Model	ZN-CTX21-A
Connectable sensor		ZN-CTM□□1-□□
Display		7-seg. 5-digit 2-step LCD display, auxiliary information indicator displays
Recording Interval		1 s, 2 s, 5 s, 10 s, 20 s, 30 s, 1 min. *1
Operation Function *2		Momentary power, Integrated power consumption
Measurement Mode		Normal mode, Sleep mode *3, High-speed logging mode
Recording Mode		Continue mode*4, Ring mode*5
External Output		Alarm output (Photocoupler output) *6
Memory Capacity (Internal)		Internal memory: approx. 6500 data items
Memory Capacity (External)		SD card (measured value and converted value saving/set value saving and reading), Recommended SD card: HMC-SD292 (2 GB) and HMC-SD492 (4 GB) (manufactured by OMRON) *7
Power Supply		DC input: 24 VDC ± 10%; Batteries: Two AAA batteries*8
Current Consumption		80 mA max.
Battery Life *9		Approx. 1 week *10
Operating Temperature		Battery Supply: -10°C to +60°C (no condensation or icing)
Operating Humidity		20% to 85% (no condensation or icing)
Storage Humidity/Temperature		-15°C to +60°C, 20% to 85% (no condensation or icing)
Insulation Resistance		20 MΩ (500 VDC)
Withstand Voltage		1000 VAC, 50/60 Hz, 1 min.: Between the case and current input circuit
Vibration Resistance		With mounting screws: 10 to 150 Hz, 0.7 mm double amplitude, acceleration: 50 m/s ² for each in X, Y and Z directions for 80 min. With mounting magnets: 10 to 55 Hz, 0.3 mm double amplitude, acceleration: 20 m/s ² for each in X, Y and Z directions for 50 min.
Shock Resistance		150 m/s ² in 6 directions (+/-X, +/-Y, and +/-Z directions), 3 times each *11
Material		ABS
Degree of Protection		IP30
Mounting		Magnet mounting, screw mounting, hook
Weight (in Package)		Approx. 500 g
Accessories		Instruction Sheet, Startup Guide, Mounting Magnets*12, Alarm Output Connector*13, DC Cable, and Ferrite Core

- 1: In high-speed logging mode, data is recorded in 83 ms at 60 Hz and in 100 ms at 50 Hz.
- 2: Momentary power and integrated power values are converted from the measured current. Correctly specify the number of used channels, applicable measurement target circuit, CT type, frequency, voltage and power factor.
- 3: The display turns OFF after 10 seconds of no user operation and recovers by a key operation when SLEEP mode is specified. LAN cannot be used when sleep mode is specified.
- 4: Automatically writes the data to the SD memory card when the internal memory reaches its capacity and continues recording until the SD card memory capacity reaches its limit. The unit stops operation if there is no SD memory card inserted when the internal memory reaches its capacity. (Recording can be resumed after inserting an SD memory card and outputting the data to it at a press of button.)
- 5: Continues the recording of the latest measured values until the internal memory reaches its capacity. (If the internal memory capacity exceeds the capacity, data is overwritten from the oldest one in the memory.)
- 6: Output when the integrated power upper limit specified in THR mode is exceeded. An alarm output is not available in SLEEP mode.
- 7: When using a third party SD card, it is recommended to use a reliable and durable industrial SD card (SD standard or SDHC standard (not compliant with SDXC standard), Class 4 or higher, flash memory type SLC or MLC type). You must confirm the operation of the SD card yourself.
- 8: Nickel-metal hydride cells or alkaline dry cells can be used. Manganese battery cells cannot be used.
- 9: Battery life varies depending on the measurement environment, recording interval, operation mode as well as the battery type and performance.
- 10: Conditions: Two AAA nickel-metal hydride cells; Sleep mode: Continue mode; Recording interval: 1 s; SD memory card: HMC-SD292; Operation temperature: 23°C; and Automatic range selection off.
- 11: The installation place must be free from physical shock when using mounting magnets.
- 12: Already installed on the product by factory default.
- 13: OMRON's XW4B-02B1-H1 connector.

■ Logging unit (rating)



Item	Model	ZN-CTX21-A
Primary side rated current		Dedicated CT (5 A/50 A/100 A/200 A)
Primary side allowable input current		120% of rated current (Continue)
Accuracy		±2.0%FS±1 digit (Ambient temperature 23°C, rated input, rated frequency) *
Measurement target frequency		50 Hz/60 Hz
Recording values		Current value, instantaneous power, integrated power consumption
Applicable circuit		Single phase two-wire, single phase three-wire, three-phase three-wire, three-phase four-wire



* An error of the dedicated CT is not included.

Item	Model	ZN-KMX21-A
Current Consumption		80 mA max.
Operating Temperature		Without Ethernet: -10°C to 40°C (no condensation or icing) With Ethernet: 0°C to 40°C (no condensation or icing)
Operating Humidity		20% to 85% (no condensation or icing)
Storage Humidity/Temperature		-15°C to +60°C, 20% to 85% (no condensation or icing)
Insulation Resistance		20 MΩ (500 VDC)
Withstand Voltage		1000 VAC, 50/60 Hz, 1 min.
Vibration Resistance		10 to 150 Hz, 0.7 mm double amplitude, acceleration: 50 m/s ² for each in X, Y and Z directions for 80 min*7
Shock Resistance		150 m/s ² in 6 directions (+/-X, +/-Y, and +/-Z directions), 3 times each*7
Material		ABS
Degree of Protection		IP30
Mounting		Magnet mounting, screw mounting, hook
Weight (in Package)		Approx. 500 g
Accessories		Instruction Sheet, Startup Guide, Alarm Output Connector*8, KM Dedicated Connection Cable(3 m), DC Cable, and Ferritecore.

- 1: Only supported for KM50-C and KM50-E.
- 2: Automatically writes the data to the SD memory card when the internal memory reaches its capacity and continues recording until the SD card memory capacity reaches its limit. The unit stops operation if there is no SD memory card inserted when the internal memory reaches its capacity. (Recording can be resumed after inserting an SD memory card and outputting the data to it at a press of button.)
- 3: Continues the recording of the latest measured values until the internal memory reaches its capacity. (If the internal memory capacity exceeds the capacity, data is overwritten from the oldest one in the memory.)
- 4: Output when the integrated power upper limit specified in THR mode is exceeded.
- 5: The maximum load is applied when 31 KM50-□ units are connected; and the minimum load, when a single KM20-B40-FLK is connected.
- 6: When using a third party SD card, it is recommended to use a reliable and durable industrial SD card (SD standard or SDHC standard (not compliant with SDXC standard), Class 4 or higher, flash memory type SLC or MLC type). You must confirm the operation of the SD card yourself.
- 7: The vibration resistance when mounted using the ZN9-EM01-S magnets (separately sold): 10 to 55 Hz, 0.3mm double amplitude, acceleration: 20m/s² for each in X, Y and Z directions for 50 min. The installation place must be free from physical shock.
- 8: OMRON's XW4B-02B1-H1 connector.

Optional **Portable Power Monitor** **Power Sensor Station**

Appearance	Product name	Model
	Mounting magnet (A set is attached to Model ZN-CTX21 and Model ZN-CTX21-A.)	ZN9-EM01-S
	Straight type (2 m)	ZN9-ED01-S
	Right angle type (2 m)	ZN9-ED02-S

Appearance	Product name	Model
	Special Cable (3 m) (One included with the ZN-KMX21 or ZN-KMX21-A.)	ZN9-KMC30
	Special Cable (3 m) For direct connection to KM-N-series Power Monitor.	ZN9-KMC30-N
	Environmental Visualization Software **1,2 Wave Inspire ES	ZN-SW11-S

*1 Operating environment/OS: Microsoft Windows 7 (32 bit/64 bit)/Microsoft Windows 10 (32 bit/64 bit)
CPU: Intel convertible processor 1 GHz minimum
Memory: 1 GB minimum (2 GB or greater is recommended)
*2 Supportable version is Ver. 2.2.1 or later.

External dimensions **Portable Power Monitor** **Power Sensor Station**

(Unit: mm)
Tolerance class IT16 applies to the dimensions unless otherwise specified.

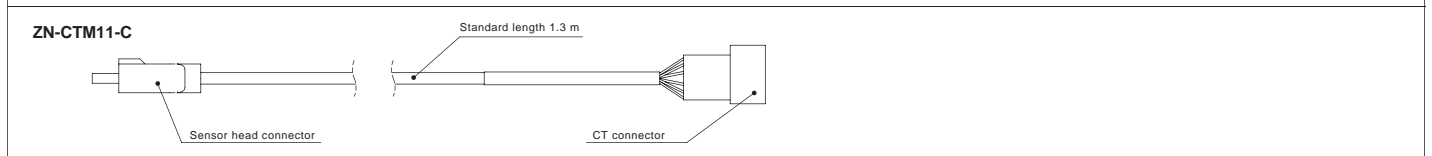
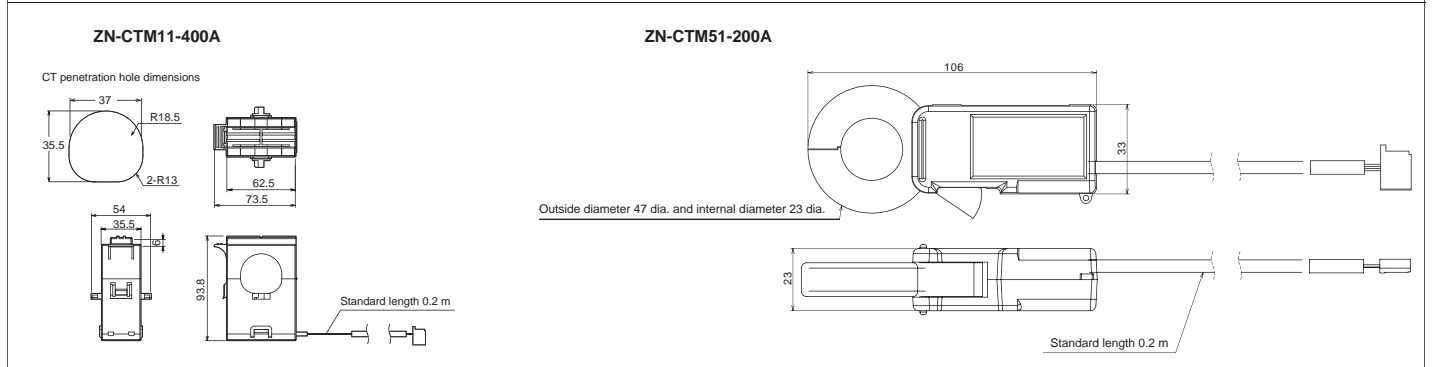
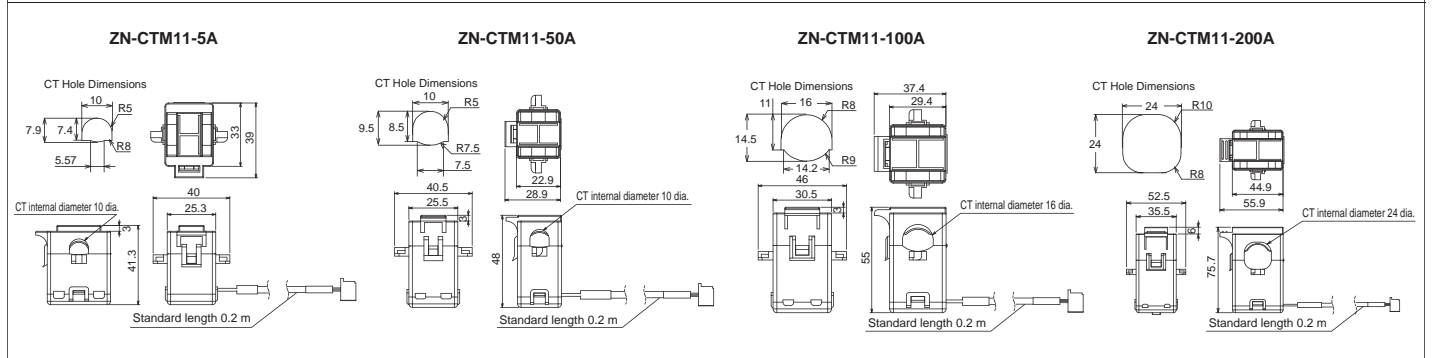
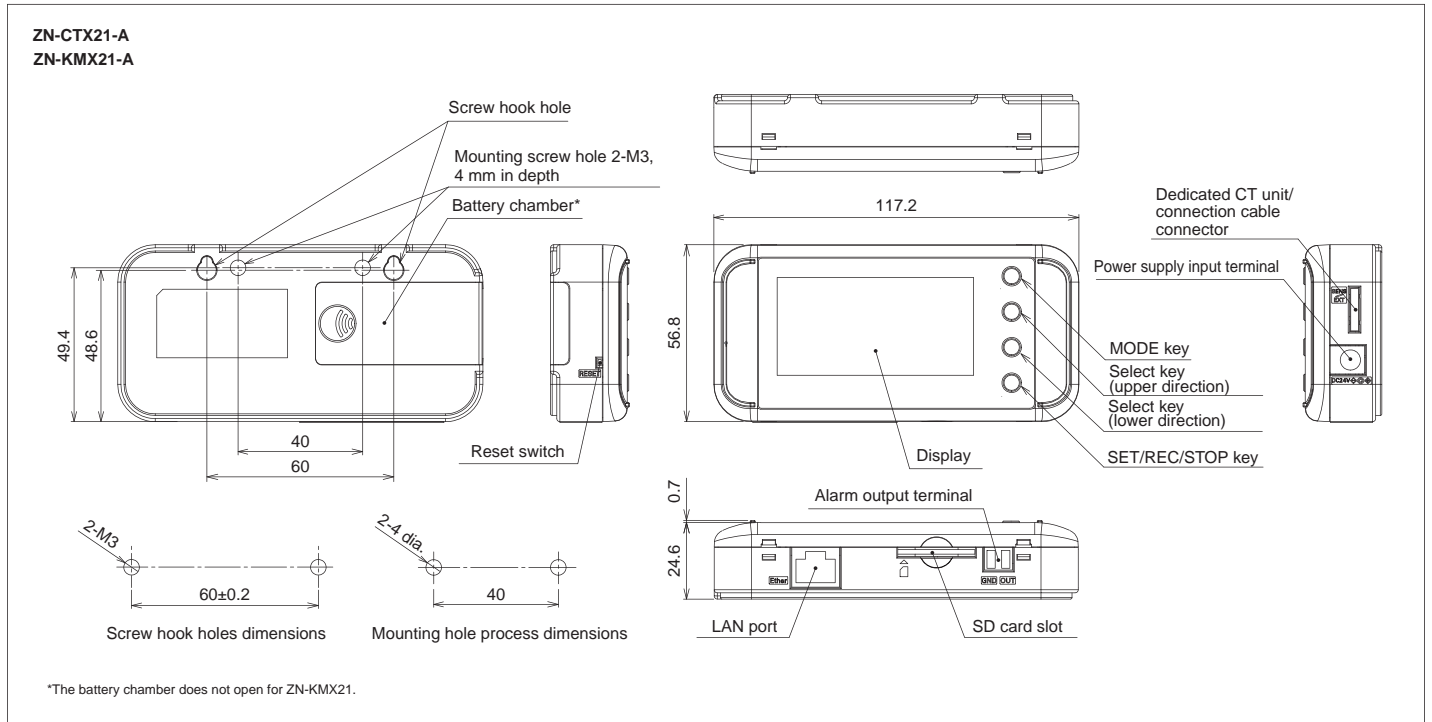

Windows is a registered trademark of Microsoft Corporation in the United States and other countries.

Note: Do not use this document to operate the Unit.

OMRON Corporation Industrial Automation Company

Kyoto, JAPAN

Contact : www.ia.omron.com

Regional Headquarters

OMRON EUROPE B.V.

Wegalaan 67-69, 2132 JD Hoofddorp
The Netherlands
Tel: (31) 2356-81-300 Fax: (31) 2356-81-388

OMRON ASIA PACIFIC PTE. LTD.

438B Alexandra Road, #08-01/02 Alexandra
Technopark, Singapore 119968
Tel: (65) 6835-3011 Fax: (65) 6835-3011

OMRON ELECTRONICS LLC

2895 Greenspoint Parkway, Suite 200
Hoffman Estates, IL 60169 U.S.A.
Tel: (1) 847-843-7900 Fax: (1) 847-843-7787

OMRON (CHINA) CO., LTD.

Room 2211, Bank of China Tower,
200 Yin Cheng Zhong Road,
PuDong New Area, Shanghai, 200120, China
Tel: (86) 21-6023-0333 Fax: (86) 21-5037-2388

Authorized Distributor:

©OMRON Corporation 2012-2023 All Rights Reserved.
In the interest of product improvement,
specifications are subject to change without notice.

CSM_13_1

Cat. No. E419-E1-06 0723 (0112)