

## **CJ Series EtherNet/IP™ Connection Guide**

**OMRON Corporation  
Displacement Sensor  
(ZW-7000 series)**

### **About Intellectual Property Rights and Trademarks**

---

Microsoft product screen shots reprinted with permission from Microsoft Corporation.

Windows is a registered trademark of Microsoft Corporation in the USA and other countries.

ODVA and EtherNet/IP™ are trademarks of ODVA.

Company names and product names in this document are the trademarks or registered trademarks of their respective companies.

---

## Table of Contents

<b>1. Related Manuals</b> .....	<b>1</b>
<b>2. Terms and Definitions</b> .....	<b>2</b>
<b>3. Precautions</b> .....	<b>3</b>
<b>4. Overview</b> .....	<b>4</b>
<b>5. Applicable Devices and Device Configuration</b> .....	<b>5</b>
5.1. Applicable Devices .....	5
5.2. Device Configuration .....	6
<b>6. EtherNet/IP Settings</b> .....	<b>8</b>
6.1. Parameters .....	8
6.2. Tag Data Link Settings .....	9
<b>7. EtherNet/IP Connection Procedure</b> .....	<b>12</b>
7.1. Work Flow .....	12
7.2. Sensor Controller Setup .....	14
7.3. PLC Setup .....	25
7.4. Network Settings .....	35
7.5. EtherNet/IP Communication Status Check .....	48
<b>8. Initialization method</b> .....	<b>55</b>
8.1. Initializing PLC .....	55
8.2. Initializing Sensor Controller .....	56
<b>9. Revision History</b> .....	<b>57</b>

## 1. Related Manuals

To ensure system safety, make sure to always read and follow the information provided in all Safety Precautions and Precautions for Safe Use in the manuals for each device which is used in the system.

Cat. No.	Model	Manual name
W472	CJ2M-CPU[] CJ2H-CPU6[] CJ2H-CPU6[]-EIP	CJ-series CJ2 CPU Unit Hardware USER'S MANUAL
W473	CJ2M-CPU[] CJ2H-CPU6[] CJ2H-CPU6[]-EIP	CJ-series CJ2 CPU Unit Software USER'S MANUAL
W465	CJ1W-EIP21 CJ2M-CPU3[] CJ2H-CPU6[]-EIP	CJ Series EtherNet/IP™ Units OPERATION MANUAL
W446	CXONE-AL[]C-V4 / AL[]D-V4	CX-Programmer OPERATION MANUAL
0969584-7	W4S1-05[] W4S1-03B	Switching Hub W4S1-series Users Manual
Z362	ZW-7000[]	Displacement Sensor ZW-7000 series Confocal Fiber Type Displacement Sensor User's Manual
Z363	ZW-7000[]	Displacement Sensor ZW-7000 series Confocal Fiber Type Displacement Sensor User's Manual for Communications Settings

## 2. Terms and Definitions

Term	Explanation and Definition
Node	<p>A programmable controller and a device are connected to an EtherNet/IP network via EtherNet/IP ports. EtherNet/IP recognizes each EtherNet/IP port connected to the network as one node.</p> <p>When a device with two EtherNet/IP ports is connected to the EtherNet/IP network, EtherNet/IP recognizes this device as two nodes. EtherNet/IP achieves the communications between programmable controllers or the communications between a programmable controller and a device by exchanging data between these nodes connected to the network.</p>
Tag	<p>A minimum unit of the data that is exchanged on the EtherNet/IP network is called a tag. The tag is defined as a network variable or as a physical address, and it is assigned to the memory area of each device.</p>
Tag set	<p>In the EtherNet/IP network, a data unit that consists of two or more tags can be exchanged. The data unit consisting of two or more tags for the data exchange is called a tag set. Up to eight tags can be configured per tag set for the programmable controllers produced by OMRON Corporation.</p>
Tag data link	<p>In EtherNet/IP, the tag and tag set can be exchanged cyclically between nodes without using a user program.</p> <p>This standard feature on EtherNet/IP is called a tag data link.</p>
Connection	<p>A connection is used to exchange data as a unit within which data concurrency is maintained. The connection consists of tags or tag sets. Creating the concurrent tag data link between the specified nodes is called a "connection establishment". When the connection is established, the tags or tag sets that configure the connection are exchanged between the specified nodes concurrently.</p>
Connection type	<p>There are two kinds of connection types for the tag data link connection. One is a multi-cast connection, and the other is a unicast (point-to-point) connection. The multi-cast connection sends an output tag set in one packet to more than one node. The unicast connection separately sends one output tag set to each node. Therefore, multi-cast connections can decrease the communications load if one output tag set is sent to more than one node.</p>
Originator and Target	<p>To operate tag data links, one node requests the opening of a communications line called a "connection".</p> <p>The node that requests to open the connection is called an "originator", and the node that receives the request is called a "target".</p>
Tag data link parameter	<p>A tag data link parameter is the setting data to operate tag data links. It includes the data to set tags, tag sets, and connections.</p>
EDS file	<p>A file that describes the number of I/O points for the EtherNet/IP device and the parameters that can be set via EtherNet/IP.</p>

## 3. Precautions

- (1) Understand the specifications of devices which are used in the system. Allow some margin for ratings and performance. Provide safety measures, such as installing a safety circuit, in order to ensure safety and minimize the risk of abnormal occurrence.
- (2) To ensure system safety, make sure to always read and follow the information provided in all Safety Precautions and Precautions for Safe Use in the manuals for each device which is used in the system.
- (3) The user is encouraged to confirm the standards and regulations that the system must conform to.
- (4) It is prohibited to copy, to reproduce, and to distribute a part or the whole of this document without the permission of OMRON Corporation.
- (5) The information contained in this document is current as of July 2016. It is subject to change for improvement without notice.

The following notations are used in this document.



Indicates a potentially hazardous situation which, if not avoided, may result in minor or moderate injury or property damage.



### Precautions for Correct Use

Precautions on what to do and what not to do to ensure proper operation and performance.



### Additional Information

Additional information to read as required.

This information is provided to increase understanding or make operation easier.

### Symbol



The triangle symbol indicates precautions (including warnings).  
The specific operation is shown in the triangle and explained in the text.  
This example indicates a general precaution.

## 4. Overview

This document describes the procedures for connecting Displacement Sensor (hereinafter referred to as Sensor Controller) to CJ-series Programmable Controller + EtherNet/IP Unit (hereinafter referred to as PLC) via EtherNet/IP, both produced by OMRON Corporation (hereinafter referred to as OMRON), and for checking their connections.

Refer to *Section 6. EtherNet/IP Settings* and *Section 7. EtherNet/IP Connection Procedure* to understand setting methods and key points to operate EtherNet/IP tag data links.

In this document, CJ-series EtherNet/IP Unit and the built-in EtherNet/IP port of CJ-series CJ2 CPU Unit are collectively called as "EtherNet/IP Unit".

## 5. Applicable Devices and Device Configuration

### 5.1. Applicable Devices

The applicable devices are as follows:

Manufacturer	Name	Model
OMRON	CJ2 CPU Unit	CJ2[]-CPU[][]
OMRON	EtherNet/IP Unit	CJ1W-EIP21 CJ2H-CPU6[]-EIP CJ2M-CPU3[]
OMRON	Confocal Fiber Type Displacement Sensor Sensor Controller Sensor Head	ZW-7000[] ZW-S70[][]



#### Precautions for Correct Use

In this document, the devices with models and versions listed in 5.2. *Device Configuration* are used as examples of applicable devices to describe the procedures for connecting the devices and checking their connections.

You cannot use devices with versions lower than the versions listed in 5.2.

To use the above devices with models not listed in 5.2. or versions higher than those listed in 5.2., check the differences in the specifications by referring to the manuals before operating the devices.



#### Additional Information

This document describes the procedures for establishing the network connections.

It does not provide information on operation, installation, wiring method, device functionality, or device operation, which is not related to the connection procedures.

Refer to the manuals or contact the device manufacturer.



**5.2. Device Configuration**

The hardware components to reproduce the connection procedures in this document are as follows:

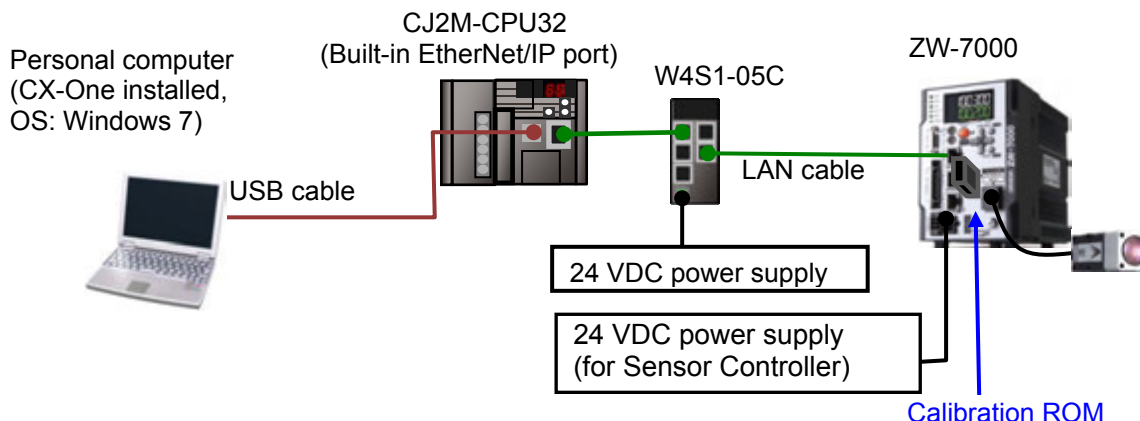

Manufacturer	Name	Model	Version
OMRON	CJ2 CPU Unit (Built-in EtherNet/IP port)	CJ2M-CPU32	Ver.2.0 (Ver.2.12)
OMRON	Power Supply Unit	CJ1W-PA202	
OMRON	Switching hub	W4S1-05C	Ver.1.00
-	24 VDC power supply (for Switching hub)	-	
OMRON	CX-One	CXONE-AL□□C-V4 /AL□□D-V4	Ver.4.□□
OMRON	CX-Programmer	(Included in CX-One)	Ver.9.61
OMRON	Network Configurator	(Included in CX-One)	Ver.3.59c
-	Personal computer (OS: Windows 7)	-	
-	USB cable (USB 2.0 type B connector)	-	
-	LAN cable (STP (shielded, twisted-pair) cable of Ethernet category 5 or higher)	-	
OMRON	Sensor Controller	ZW-7000	Ver.2.020
OMRON	Sensor Head	ZW-S7030	
OMRON	Calibration ROM	(Supplied with Sensor Head)	
OMRON	24 VDC power supply (for Sensor Controller) (24 VDC, 2.5A, 60W)	S8VS-06024	



**Precautions for Correct Use**

Update CX-Programmer and Network Configurator to the version specified in this *Clause 5.2.* or to a higher version. If you use a version higher than the one specified, the procedures and related screenshots described in *Section 7.* and subsequent sections may not be applicable. In that case, use the equivalent procedures described in this document by referring the *CX-Programmer OPERATION MANUAL* (Cat. No. W446) and *Network Configurator Online Help.*



### **Additional Information**

---

For specifications of 24 VDC power supply available for Switching hub, refer to the *Switching Hub W4S1-series Users Manual* (Cat. No. 0969584-7).

---



### **Additional Information**

---

For specifications of 24 VDC power supply available for Sensor Controller, refer to the *Displacement Sensor ZW-7000 series Confocal Fiber Type Displacement Sensor User's Manual* (Cat. No. Z362).

---



### **Additional Information**

---

The system configuration in this document uses USB for the connection between Personal computer and PLC. For information on how to install the USB driver, refer to *A-5 Installing the USB Driver* of the *CJ-series CJ2 CPU Unit Hardware User's Manual* (Cat. No. W472).

---

## 6. EtherNet/IP Settings

This section describes the contents of parameter and tag data link settings that are all defined in this document.

### 6.1. Parameters

The parameters required for connecting PLC to Sensor Controller via EtherNet/IP are shown below.

Item	PLC (Node 1)	Sensor Controller (Node 50)
IP address	192.168.250.1	192.168.250.50
Subnet mask	255.255.255.0	255.255.255.0
Fieldbus	-	EtherNet/IP

## 6.2. Tag Data Link Settings

The following shows the content of tag data link settings for Sensor Controller.

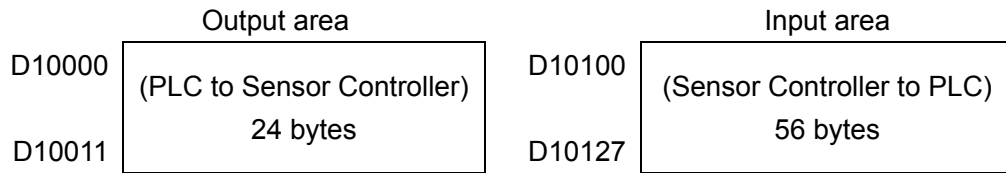

### ■ Output area

Address	Bit	Function name
D10000	0	Sensor head control signal 1 (lower 16 bits) Control command execution
	1 to 15	Reserved
	0	Sensor head control signal 1 (upper 16 bits) Error clear
D10001	1 to 15	Reserved
	0	Sensor head control signal 2 (lower 16 bits) Timing
D10002	1	Reset
	2	Light metering OFF
	4 to 15	Reserved
	0	Sensor head control signal 2 (upper 16 bits) TASK1 Zero reset execution
D10003	1	TASK2 Zero reset execution
	2	TASK3 Zero reset execution
	3	TASK4 Zero reset execution
	4	TASK1 Zero reset cancel
	5	TASK2 Zero reset cancel
	6	TASK3 Zero reset cancel
	7	TASK4 Zero reset cancel
	8 to 15	Reserved
D10004	0 to 15	Extended area (lower 16 bits)
D10005	0 to 15	Extended area (upper 16 bits)
D10006	0 to 15	Command code (lower 16 bits)
D10007	0 to 15	Command code (upper 16 bits)
D10008	0 to 15	Command parameter 1
D10009	0 to 15	Command parameter 2
D10010	0 to 15	Command parameter 3 (lower 16 bits)
D10011	0 to 15	Command parameter 4 (upper 16 bits)

## ■ Input area

Address	Bit	Function name
D10100		Sensor head status signal 1 (lower 16 bits)
	0	Control command completion
	1	Reserved
	2	Ready
	3	Reserved
	4	Run screen
	5 to 10	Reserved
	11	Current bank number bit0
	12	Current bank number bit1
	13	Current bank number bit2
	14	Current bank number bit3
	15	Current bank number bit4
D10101		Sensor head status signal 1 (upper 16 bits)
	0	Error
	1 to 15	Reserved
D10102		Sensor head status signal 2 (lower 16 bits)
	0	Hold execution status
	1	Reset execution state
	2	Logical beam lighting state
	3	Measurement position
	4	Measurement state
	5	Data output completed
	6	Overall judgment result
	7	Reserved
	8	TASK1 TASK status
	9	TASK2 TASK status
	10	TASK3 TASK status
	11	TASK4 TASK status
12 to 15	Reserved	
D10103		Sensor head status signal 2 (upper 16 bits)
	0	TASK1 Zero reset state
	1	TASK2 Zero reset state
	2	TASK3 Zero reset state
	3	TASK4 Zero reset state
	4	TASK1 HIGH output
	5	TASK1 PASS output
	6	TASK1 LOW output
	7	TASK2 HIGH output
	8	TASK2 PASS output
	9	TASK2 LOW output
	10	TASK3 HIGH output
	11	TASK3 PASS output
	12	TASK3 LOW output
	13	TASK4 HIGH output
	14	TASK4 PASS output
15	TASK4 LOW output	

Address	Bit	Function name
D10104	0 to 15	Extended area (lower 16 bits)
D10105	0 to 15	Extended area (upper 16 bits)
D10106	0 to 15	Command code echo (lower 16 bits)
D10107	0 to 15	Command code echo (upper 16 bits)
D10108	0 to 15	Response code (lower 16 bits)
D10109	0 to 15	Response code (upper 16 bits)
D10110	0 to 15	Response data (lower 16 bits)
D10111	0 to 15	Response data (upper 16 bits)
D10112	0 to 15	Output data 0 (lower 16 bits)
D10113	0 to 15	Output data 0 (upper 16 bits)
D10114	0 to 15	Output data 1 (lower 16 bits)
D10115	0 to 15	Output data 1 (upper 16 bits)
D10116	0 to 15	Output data 2 (lower 16 bits)
D10117	0 to 15	Output data 2 (upper 16 bits)
D10118	0 to 15	Output data 3 (lower 16 bits)
D10119	0 to 15	Output data 3 (upper 16 bits)
D10120	0 to 15	Reserved
D10121	0 to 15	
D10122	0 to 15	
D10123	0 to 15	
D10124	0 to 15	
D10125	0 to 15	
D10126	0 to 15	
D10127	0 to 15	

## 7. EtherNet/IP Connection Procedure

This section describes the procedures for connecting PLC and Sensor Controller on the EtherNet/IP network.

The explanations of procedures for setting up PLC and Sensor Controller given in this document are based on the factory default settings.

For the initialization, refer to *Section 8. Initialization Method*.

### 7.1. Work Flow

Take the following steps to operate tag data links by connecting PLC and Sensor Controller via EtherNet/IP.

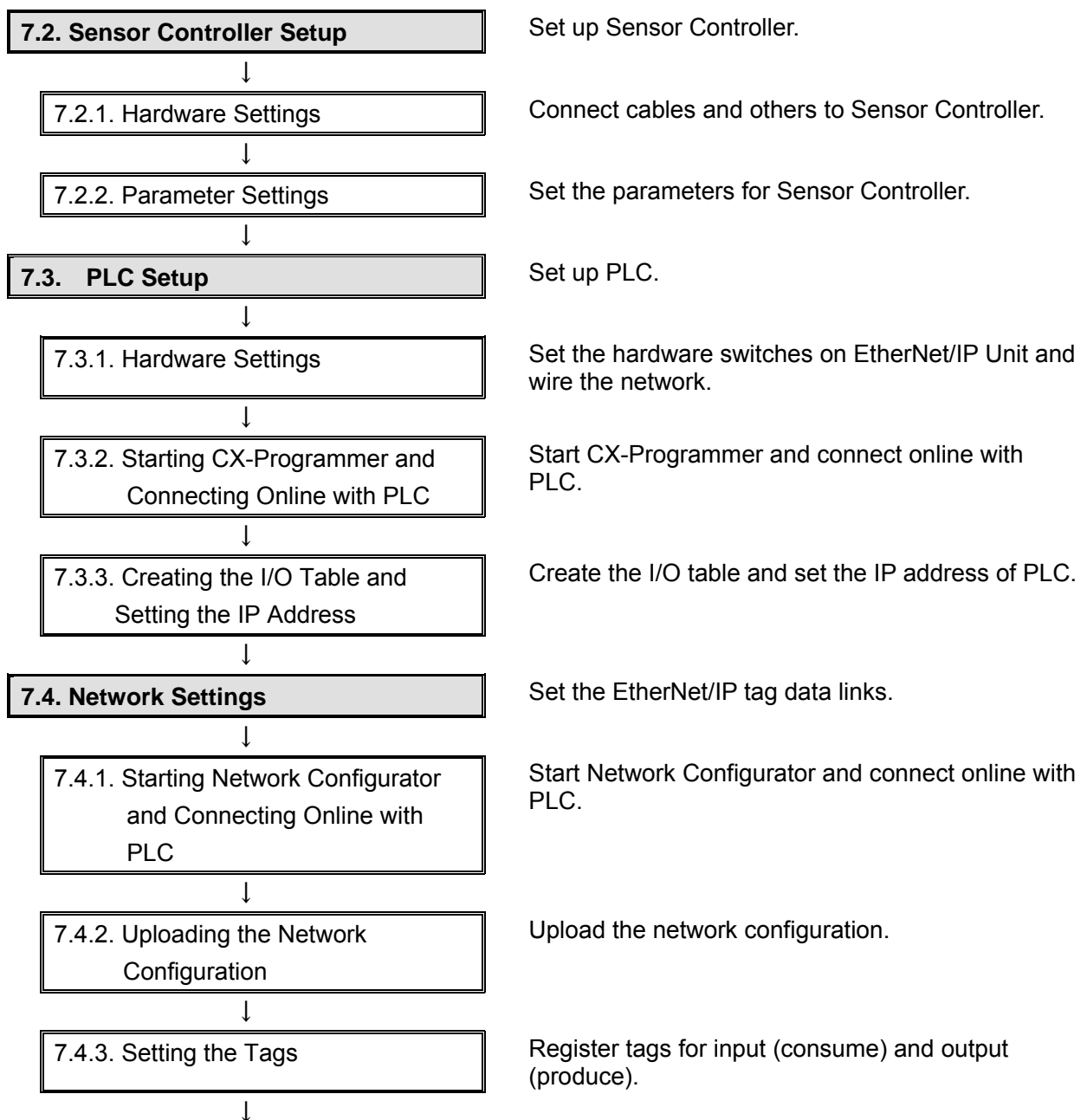

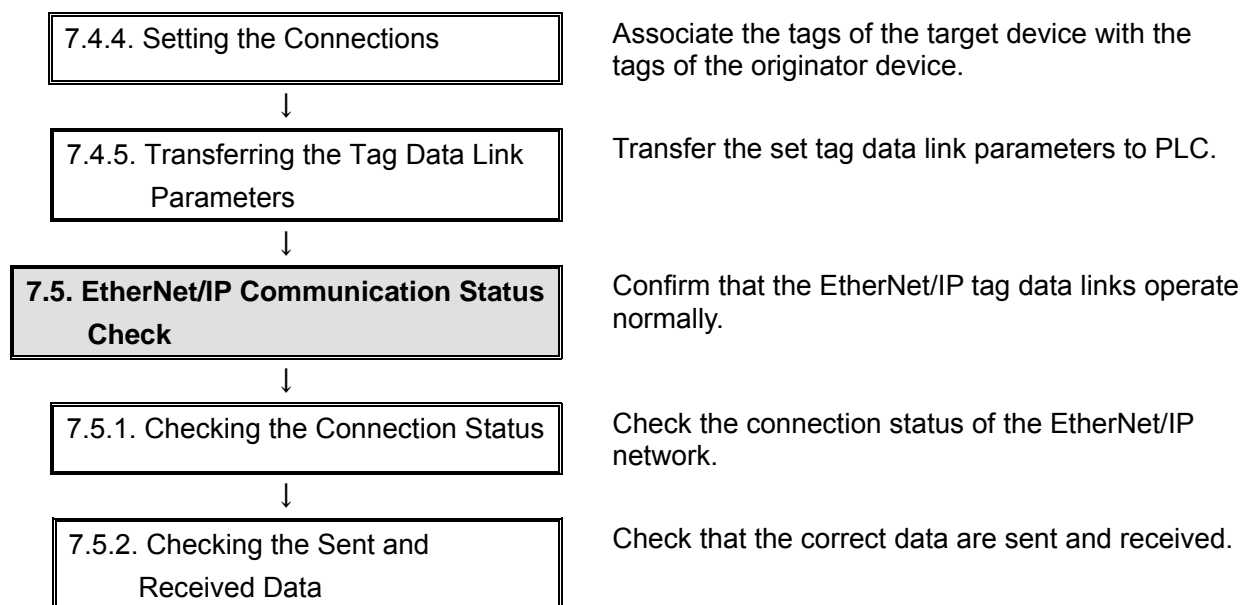



## 7.2. Sensor Controller Setup

Set up Sensor Controller.

### 7.2.1. Hardware Settings

Connect cables and others to Sensor Controller.



#### Precautions for Correct Use

Make sure that the power supply is OFF when you set up.

- 1 Make sure that Sensor Controller is powered OFF.

\*If it is ON, the settings described in the following steps and subsequent procedures may not be applicable.

- 2 Check the position of connectors on Sensor Controller by referring to the figure on the right.

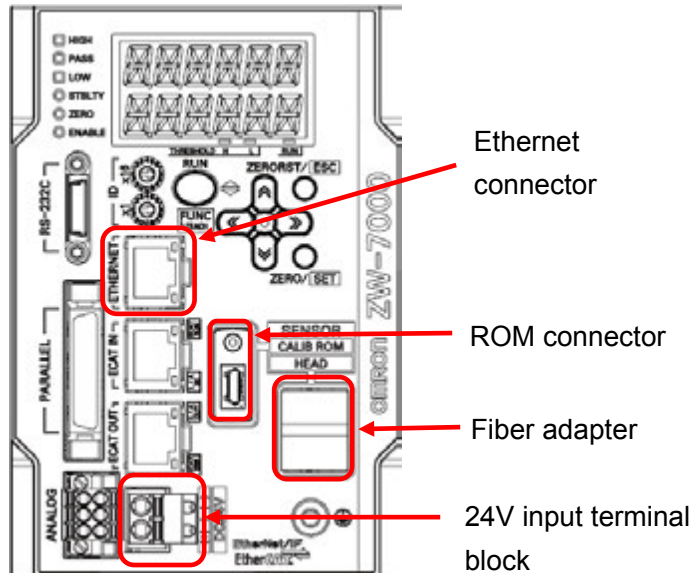

- 3 Connect the calibration ROM to ROM connector.

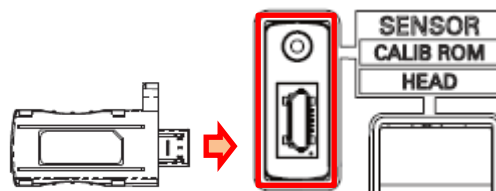

- 4 Connect Fiber connector on Sensor Head to Fiber adapter.

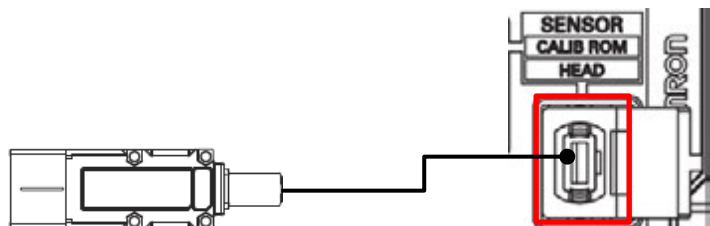

- 5 Connect Switching hub and Ethernet connector on Sensor Controller with a LAN cable. Connect 24 VDC power supply (for Switching hub) to Switching hub.

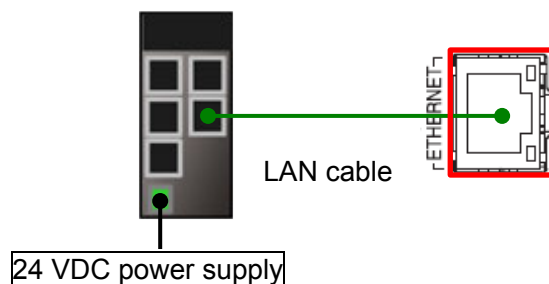

- 6 Connect 24 VDC power supply to 24 V input terminal block.

\*For details on specifications of 24 VDC power supply available for Sensor Controller, refer to the *Displacement SensorZW-7000 series Confocal Fiber Type Displacement Sensor User's Manual* (Cat. No. Z362).

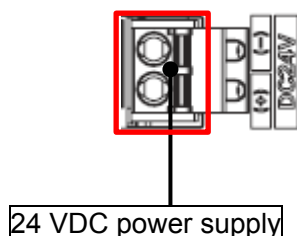

7.2.2. Parameter Settings

Set the parameters for Sensor Controller.

<p>1</p>	<p>Check the positions of each key and displays to use for parameter settings.</p>	<p>Main Display (White)          Sub-display (Green)          RUN Indicator (Green)          ZERORST/ESC Key          ↑ (UP) Key          → (RIGHT) Key          ZERO/SET Key          ↓ (DOWN) Key          ← (LEFT) Key          Mode Switching Key</p>
<p>2</p>	<p>Turn ON Sensor Controller.</p>	
<p>3</p>	<p>The system enters the RUN mode after displaying "INIT" for a few seconds.</p> <p>*The RUN Indicator is lit in the RUN mode.</p> <p>Press and hold the <b>Mode Switching</b> Key for two seconds.</p>	<p>THRESHOLD H L RUN</p>
<p>4</p>	<p>OK/CAN is displayed. Press the <b>ZERO/SET</b> Key.</p>	

- 5 The operation mode is switched to the FUNC mode, and SENS is displayed on Main Display.

\*The RUN Indicator goes out in the FUNC mode.

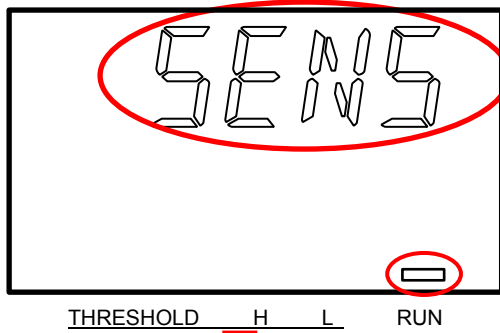

Keep pressing the →(RIGHT) or the ←(LEFT) Keys until SYSTEM is displayed.

Press the ZERO/SET Key.

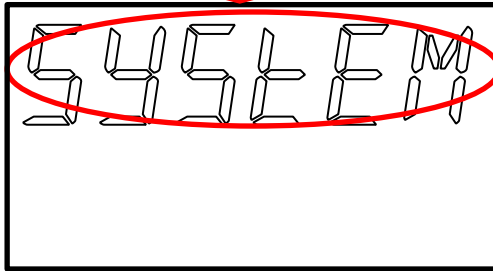

- 6 H.CALIB is displayed on Main Display.

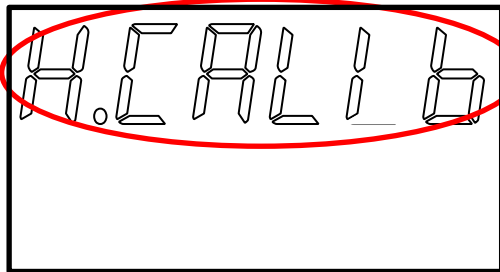

Keep pressing the →(RIGHT) or the ←(LEFT) Keys until COM is displayed.

Press the ZERO/SET Key.

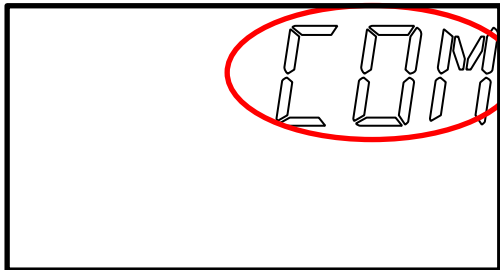

- 7 RS232C is displayed on Main Display.

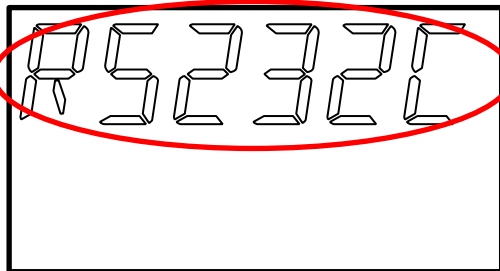

Change the menu from RS232C to ETN by pressing the →(RIGHT) Key.

Press the ZERO/SET Key.

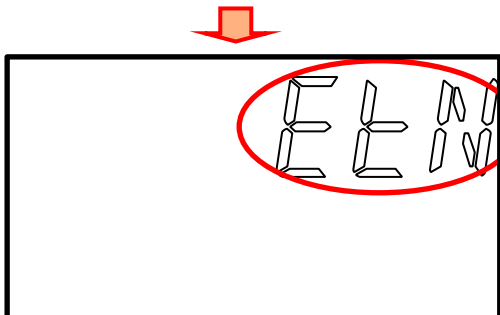

- 8 IPADDR is displayed on Main Display.

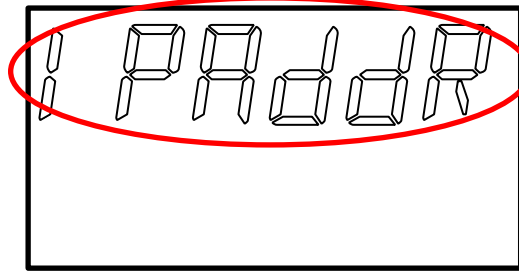

Press the **ZERO/SET** Key.

- 9 IP1 is displayed on Main Display.

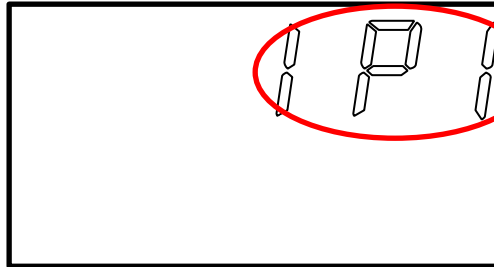

Press the **ZERO/SET** Key.

Check that 192 is displayed on Sub-display.

\*The set value here is the first octet "192" of the IP address 192.168.250.50.

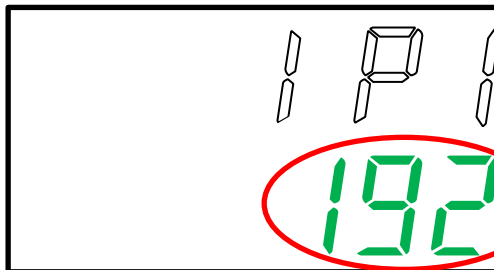

\*If the value is different, press the **ZERO/SET** Key. The Sub-display changes to the editing mode that enables you to edit the value. An editable digit of the value blinks.

Select the digit you want to change by pressing the → **(RIGHT)** or the ← **(LEFT)** Keys.

Change the value by pressing the ↑ **(UP)** or the ↓ **(DOWN)** Keys.

Press the **ZERO/SET** Key again to fix the set value.

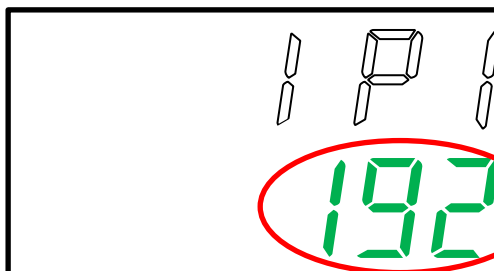
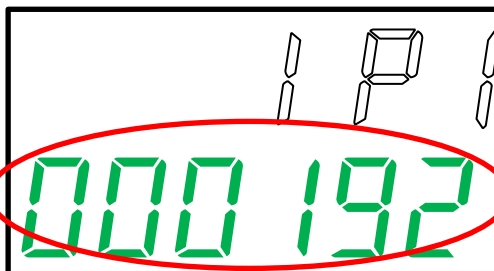

Press the **ZERORST/ESC** Key. The first menu shown in this step is displayed again. Press the → **(RIGHT)** Key.

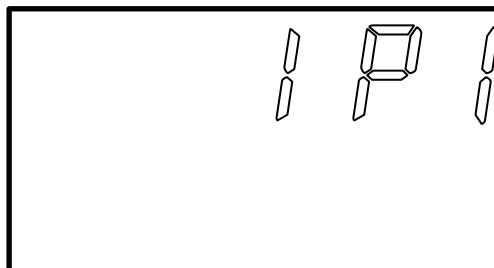

10 IP2 is displayed on Main Display.

Press the **ZERO/SET** Key.

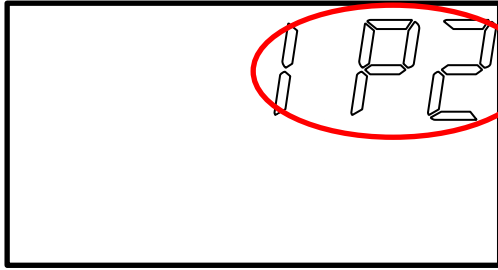

Check that 168 is displayed on Sub-display.

\*The set value here is the second octet "168" of the IP address 192.168.250.50.

\*If the value is different, change the value in the same way as step 9.

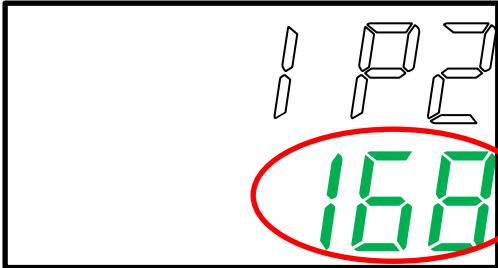

Press the **ZERORST/ESC** Key.

The first menu shown in this step is displayed again.

Press the **→(RIGHT)** Key.

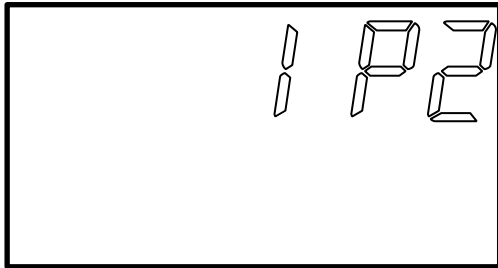

11 IP3 is displayed on Main Display.

Press the **ZERO/SET** Key.

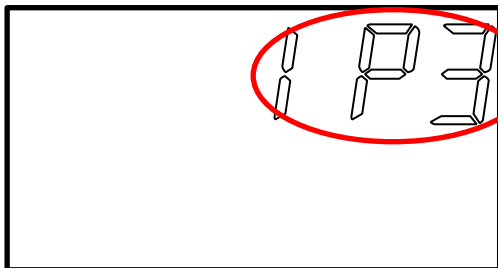

Check that 250 is displayed on Sub-display.

\*The set value here is the third octet "250" of the IP address 192.168.250.50.

\*If the value is different, change the value in the same way as step 9.

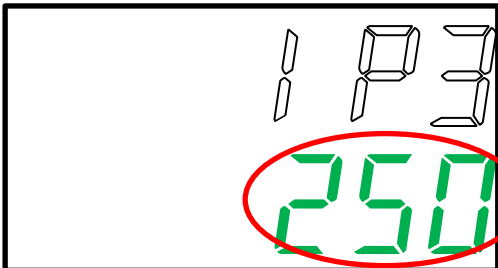

Press the **ZERORST/ESC** Key.

The first menu shown in this step is displayed again.

Press the **→(RIGHT)** Key.

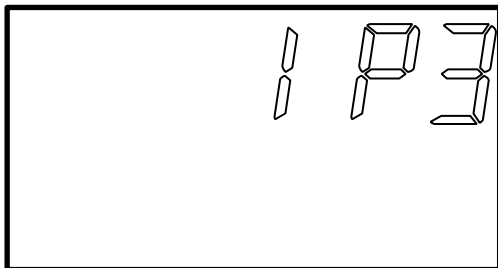

12 IP4 is displayed on Main Display.

Press the **ZERO/SET** Key.

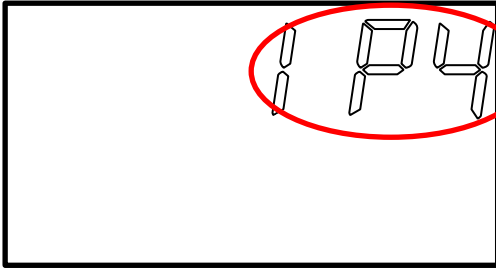

Check that 50 is displayed on Sub-display.

\*The set value here is the fourth octet "50" of the IP address 192.168.250.50.

\*If the value is different, change the value in the same way as step 9.

Press the **ZERORST/ESC** Key.  
The first menu shown in this step is displayed again.

Press the **ZERORST/ESC** Key.

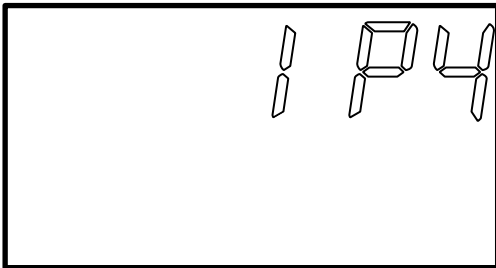
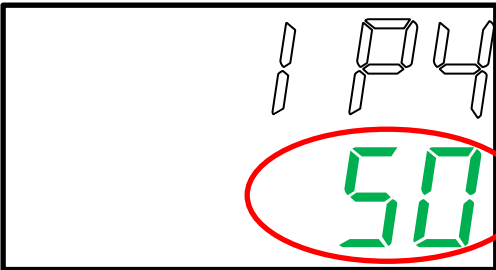

13 IPADDR is displayed on Main Display.

Change the menu to SUBNET by pressing the →(RIGHT) Key.

Press the **ZERO/SET** Key.

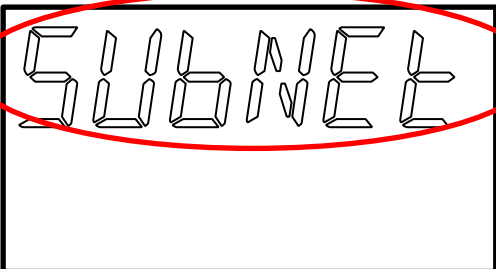
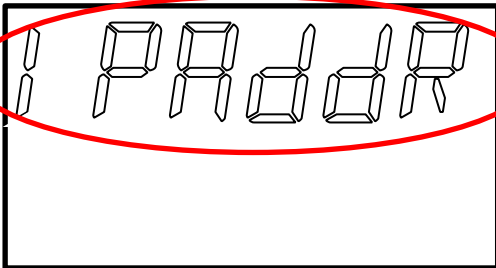

14 SUB1 is displayed on Main Display.

Press the **ZERO/SET** Key.

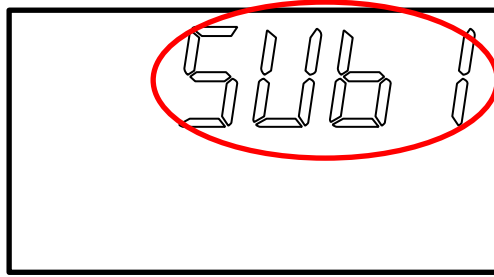

Check that 255 is displayed on Sub-display.

\*The set value here is the first octet "255" of the subnet mask 255.255.255.0.

\*If the value is different, change the value in the same way as step 9.

Press the **ZERORST/ESC** Key.

The first menu shown in this step is displayed again.

Press the **→(RIGHT)** Key.

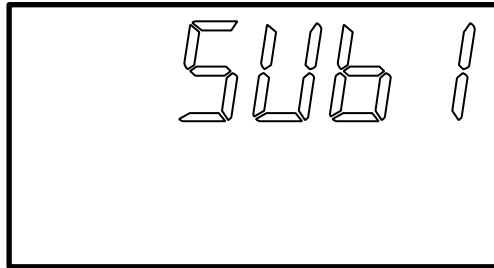
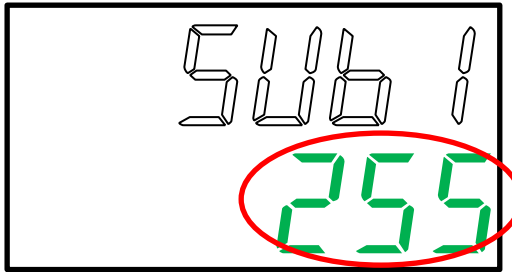

15 SUB2 is displayed on Main Display.

Press the **ZERO/SET** Key.

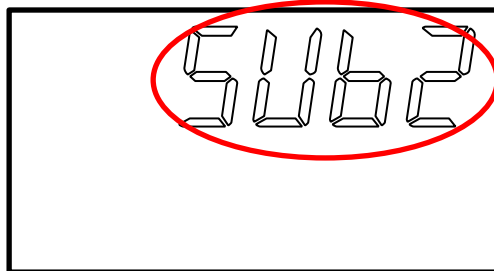

Check that 255 is displayed on Sub-display.

\*The set value here is the second octet "255" of the subnet mask 255.255.255.0.

\*If the value is different, change the value in the same way as step 9.

Press the **ZERORST/ESC** Key.

The first menu shown in this step is displayed again.

Press the **→(RIGHT)** Key.

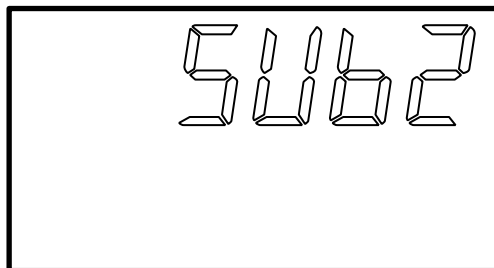
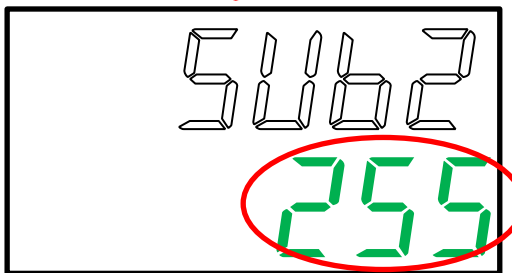



16 SUB3 is displayed on Main Display.

Press the **ZERO/SET** Key.

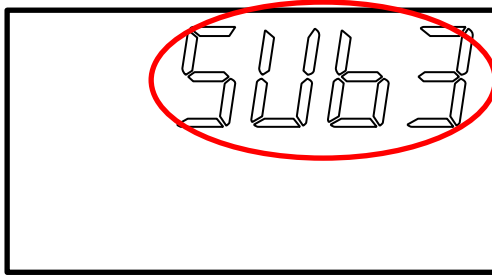

Check that 255 is displayed on Sub-display.

\*The set value here is the third octet "255" of the subnet mask 255.255.255.0.

\*If the value is different, change the value in the same way as step 9.

Press the **ZERORST/ESC** Key.

The first menu shown in this step is displayed again.

Press the **→(RIGHT)** Key.

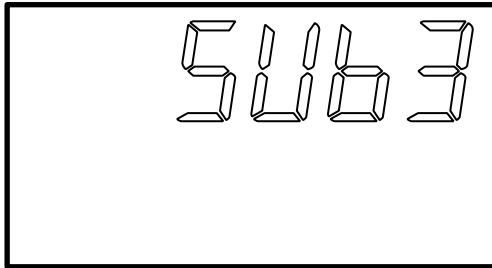
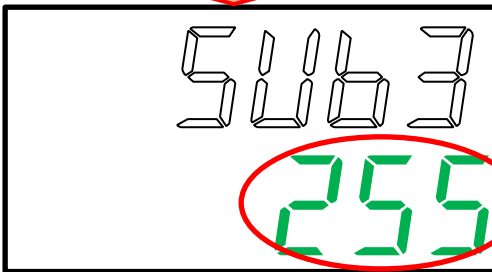

17 SUB4 is displayed on Main Display.

Press the **ZERO/SET** Key.

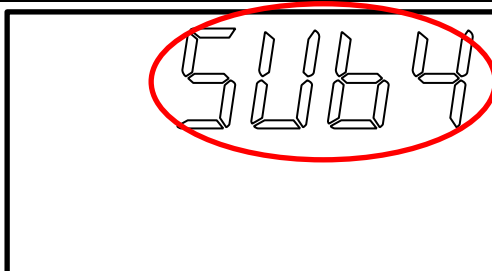

Check that 0 is displayed on Sub-display.

\*The set value here is the fourth octet "0" of the subnet mask 255.255.255.0.

\*If the value is different, change the value in the same way as step 9.

Press the **ZERORST/ESC** Key.

The first menu shown in this step is displayed again.

Press the **ZERORST/ESC** Key twice.

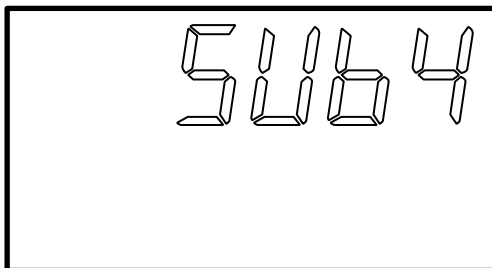
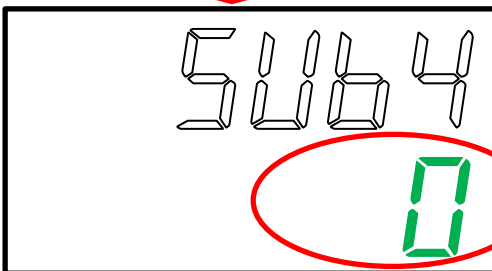

18 ETN is displayed on Main Display.

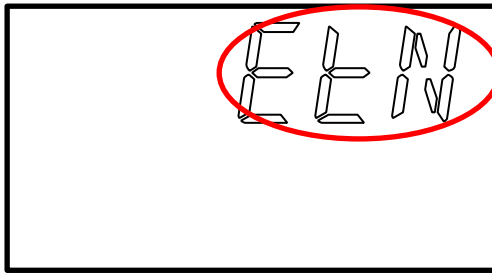

Change the menu to MEMLNK by pressing the →(RIGHT) Key twice.

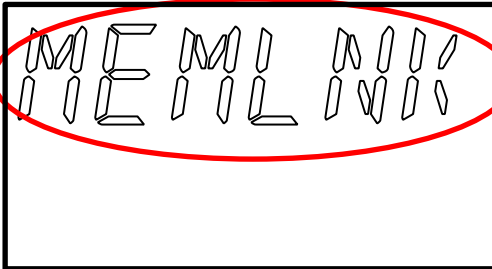

Press the ZERO/SET Key.

19 E-CAT is displayed on Sub-display.



Press the ↑(UP) Key to change the menu to EIP in blinking.  
EIP stops blinking when pressing the ZERO/SET Key.

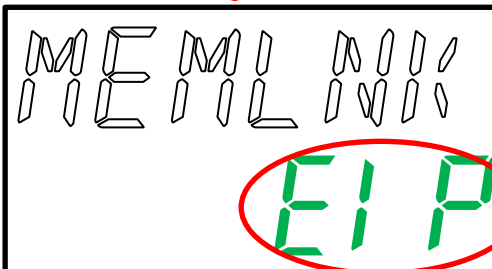

\*The memory link function is set to EtherNet/IP.

Press and hold the **Mode Switching** Key for two seconds.

20 OK/CAN is displayed.  
Press the **ZERO/SET** Key.

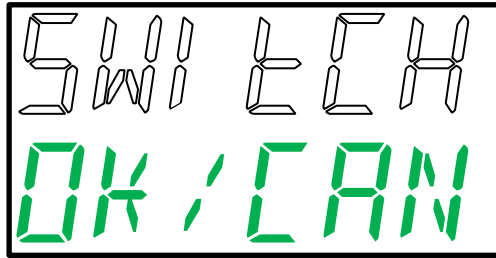

SAVE is displayed on Main Display.  
Press the **ZERO/SET** Key.

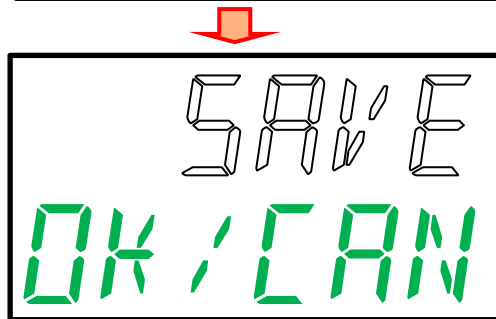

21 The operation mode is switched to the RUN mode.

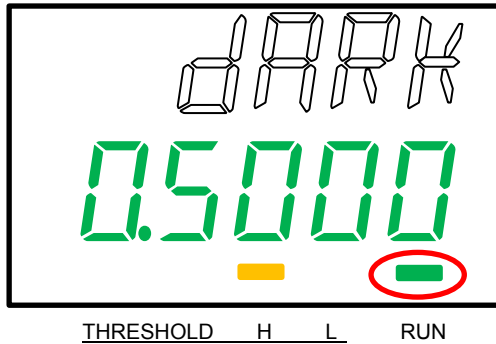

22 Power cycle Sensor Controller.

\*The saved setting data become valid after power cycling.

### 7.3. PLC Setup

Set up PLC.



#### 7.3.1. Hardware Settings

Set the hardware switches on EtherNet/IP Unit and wire the network.

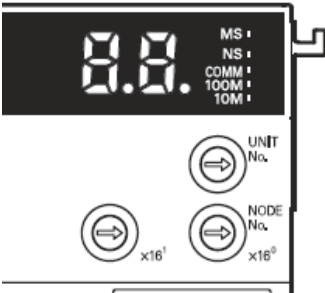

#### Precautions for Correct Use

Make sure that the power supply is OFF when you set up.

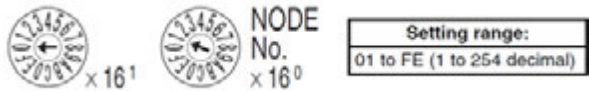
1	<p>Make sure that PLC and Switching hub are powered OFF.</p> <p>*If either of them is ON, the settings described in the following steps and subsequent procedures may not be applicable.</p>
2	<p>Check the position of the hardware switches on the front panel of EtherNet/IP Unit by referring to the figure on the right.</p> <div style="display: flex; align-items: center;">  <div style="margin-left: 20px;"> <p>← LED Indicators</p> <p>← Unit number setting switch</p> <p>← Node address setting switches</p> </div> </div>
3	<p>Set Unit number setting switch to 0.</p> <p>The unit number is used to identify individual CPU Bus Units when more than one CPU Bus Unit is mounted to the same PLC. Use a small screwdriver to make the setting, taking care not to damage the rotary switch. The unit number is factory-set to 0.</p> <div style="display: flex; align-items: center;">  <div style="margin-left: 10px;"> <p>UNIT No.</p> <p>Setting range: 0 to F</p> </div> </div>
4	<p>Set Node address setting switches to the following default settings.</p> <p>NODE No.x16<sup>1</sup>: 0                  NODE No.x16<sup>0</sup>: 1</p> <p>*The IP address is set to 192.168.250.1.</p> <p>*By default, the first to third octets of the local IP address are fixed to 192.168.250. The fourth octet is a value that is set with Node address setting switches.</p> <p>With the FINS communications service, when there are multiple EtherNet/IP Units connected to the Ethernet network, the EtherNet/IP Units are identified by node addresses. Use the node address switches to set the node address between 01 and FE hexadecimal (1 to 254 decimal). Do not set a number that has already been set for another node on the same network.</p> <div style="display: flex; align-items: center;">  </div> <p>The left switch sets the sixteens digit (most significant digit) and the right switch sets the ones digit (least significant digit). The node address is factory-set to 01.                  Default IP address = 192.168.250.node address                  With the factory-default node address setting of 01, the default IP address is 192.168.250.1.</p>

5 Connect a LAN cable to the EtherNet/IP port on PLC, and connect a USB cable to the USB port. As shown in 5.2. *Device Configuration*, connect Personal computer and Switching Hub to PLC.

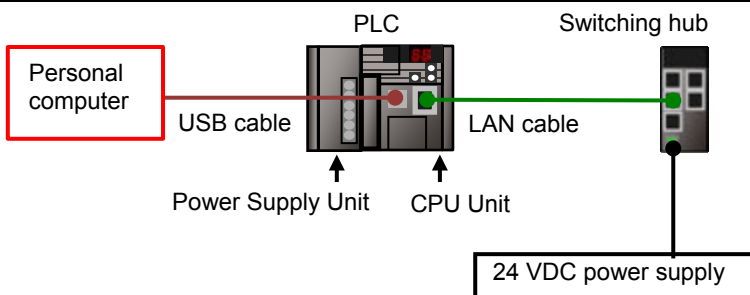

6 Turn ON PLC and Switching hub.



7 The set IP address is displayed on the seven-segment LED indicators. Afterwards, the last digit of the IP address is displayed in hexadecimal during normal operation.

7.3.2. Starting CX-Programmer and Connecting Online with PLC

Start CX-Programmer and connect online with PLC.

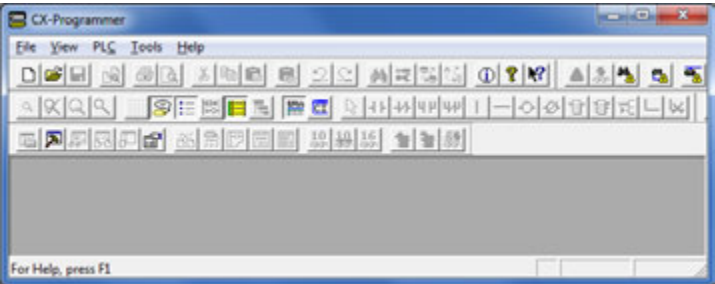
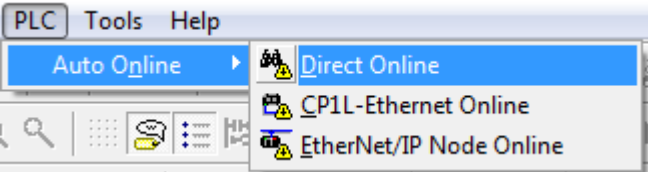
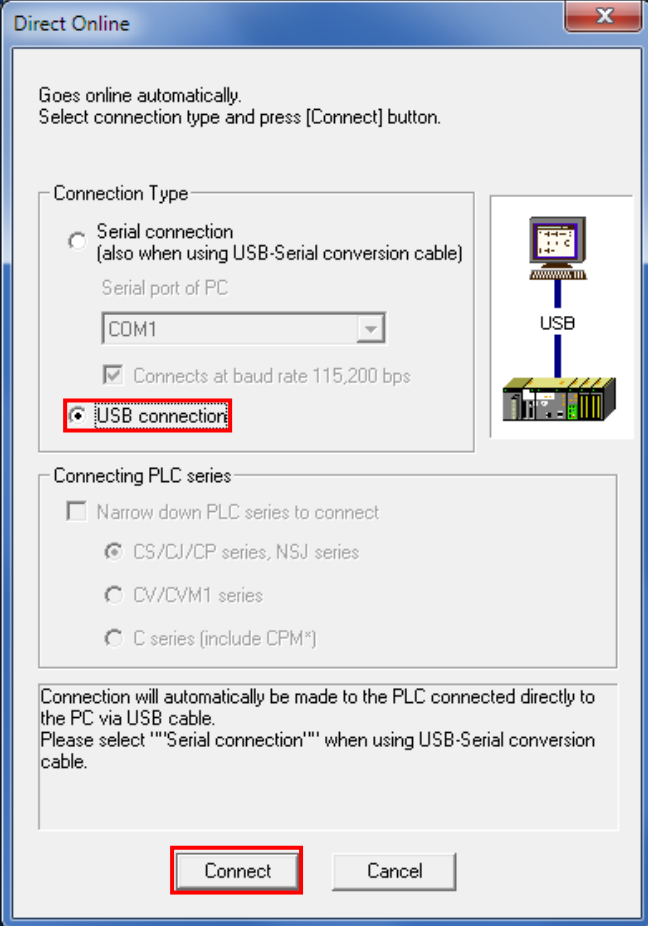
Install CX-One and the USB driver on Personal computer beforehand.

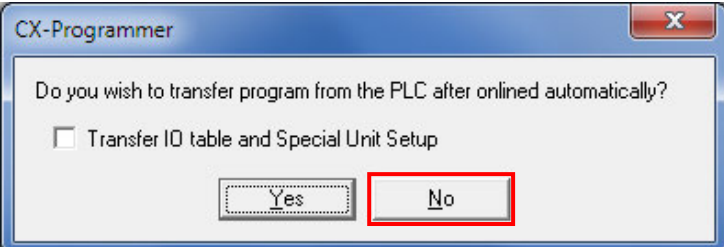
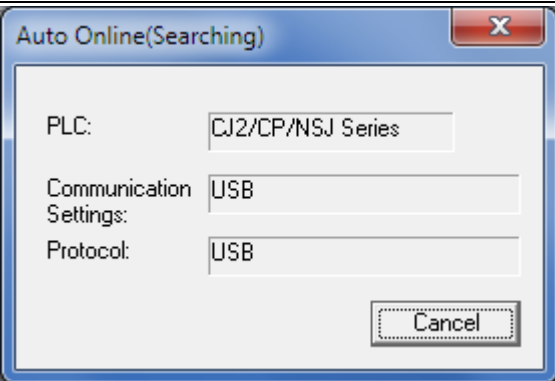
<p>1</p>	<p>Start CX-Programmer.</p> <p>*If the User Account Control Dialog Box is displayed at start, make a selection to start CX-Programmer.</p>	
<p>2</p>	<p>CX-Programmer starts.</p>	
<p>3</p>	<p>Select <b>Auto Online - Direct Online</b> from the PLC Menu.</p>	
<p>4</p>	<p>The Direct Online Dialog Box is displayed.</p> <p>Select <b>USB connection</b> as Connection Type.</p> <p>Click <b>Connect</b>.</p>	

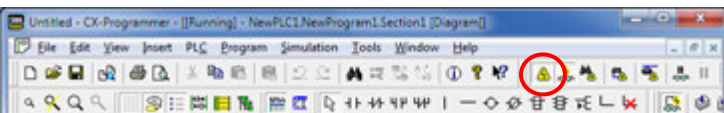
5	The dialog box on the right is displayed. Check the contents and click <b>No</b> .	
6	The dialog box on the right is displayed. CX-Programmer and PLC are automatically connected.	
7	Check that CX-Programmer and PLC are normally connected online.  *The  icon is pressed down during online connection.	



#### Additional Information

If PLC cannot be connected online, check the cable connection.

Or, return to step 1, check the settings and repeat each step.

For details, refer to *Connecting Directly to a CJ2 CPU Unit Using a USB Cable* of the *CX-Programmer OPERATION MANUAL* (Cat. No. W446).



#### Additional Information

The dialog boxes explained in the following procedures may not be displayed depending on the environmental settings of CX-Programmer.

For details on the environmental settings, refer to *Options and Preferences* in *CHAPTER 3 Project Reference* in *PART 1: CX-Programmer* of the *CX-Programmer OPERATION MANUAL* (Cat. No. W446). This document explains the setting procedures when "Confirm all operations affecting the PLC" is selected.

7.3.3. Creating the I/O Table and Setting the IP Address

Create the I/O table and set the IP address of PLC.

1 If the operating mode of PLC is Run Mode or Monitor Mode, change it to Program Mode by following the steps below.

(1) Select **Operating Mode - Program** from the PLC Menu in CX-Programmer.

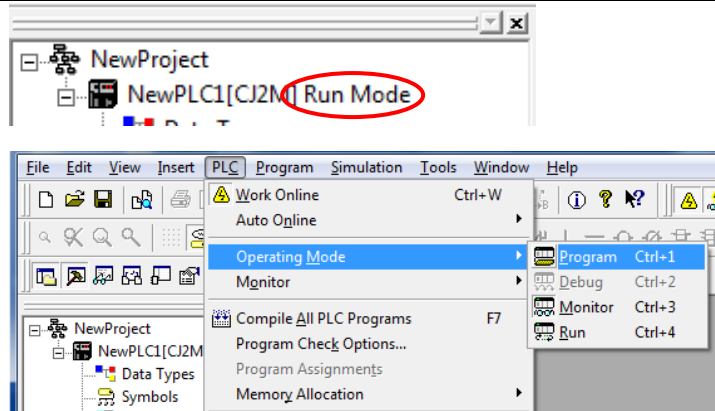

(2) The dialog box on the right is displayed. Confirm that there is no problem, and click **Yes**. \*Refer to *Additional Information* on the previous page for the settings concerning the dialog display.

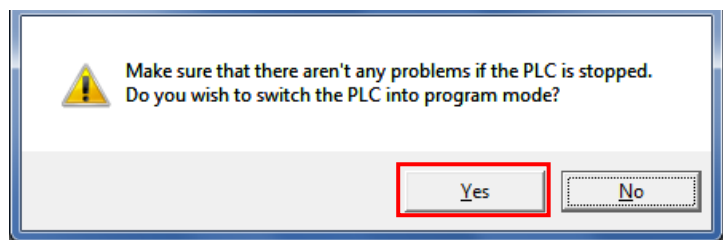

(3) Check that Stop/Program Mode is displayed on the right of the PLC model in the Project Workspace of CX-Programmer.

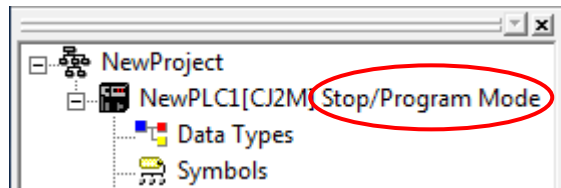

(Project Workspace)

2 Select **Edit - I/O Table and Unit Setup** from the PLC Menu in CX-Programmer.

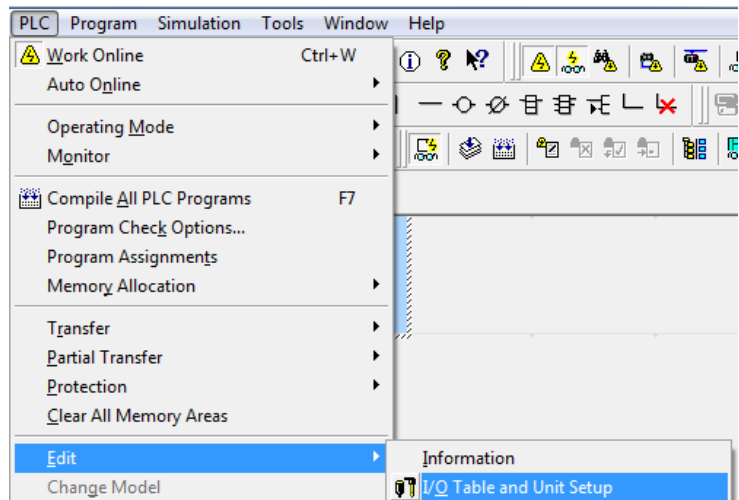

The PLC IO Table Window is displayed.

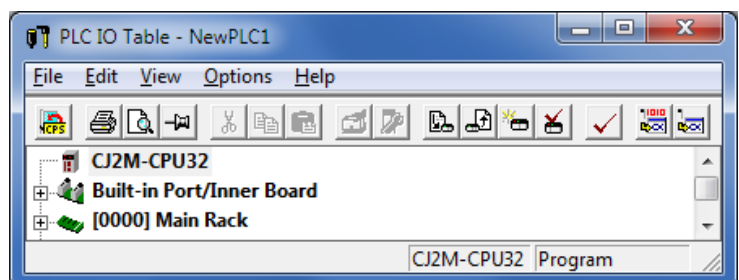





### Precautions for Correct Use

The PLC is reset after creating and transferring the I/O table in step 3 and subsequent steps. Always confirm safety before creating and transferring the I/O table.

- 3 Select **Create** from the Options Menu in the PLC IO Table Window.

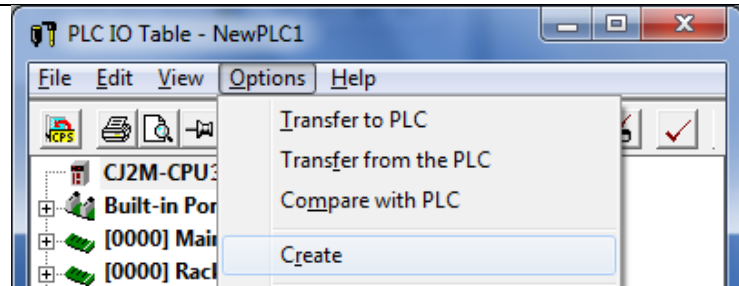

The dialog box on the right is displayed. Confirm that there is no problem, and click **Yes**.

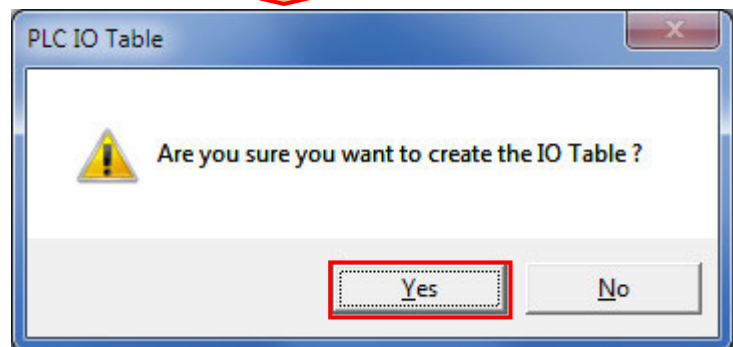

The dialog box on the right is displayed. Confirm that there is no problem, and click **Yes**.

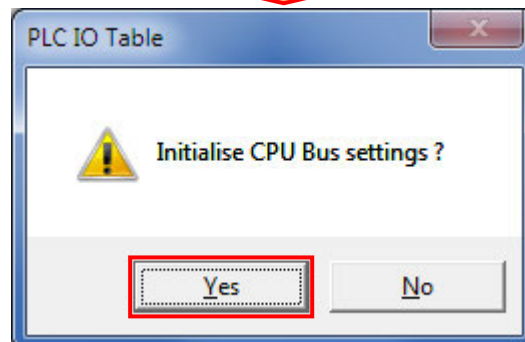

- 4 The Transfer from PLC Dialog Box is displayed.  
Select *IO Table* and *SIO Unit Parameters*.  
Click **Transfer**.

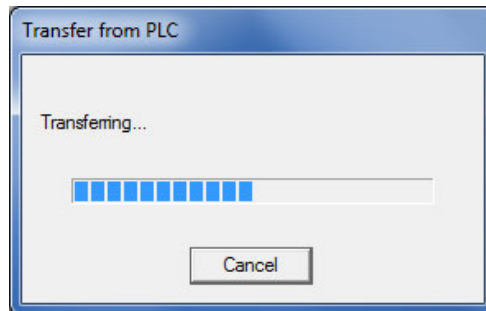
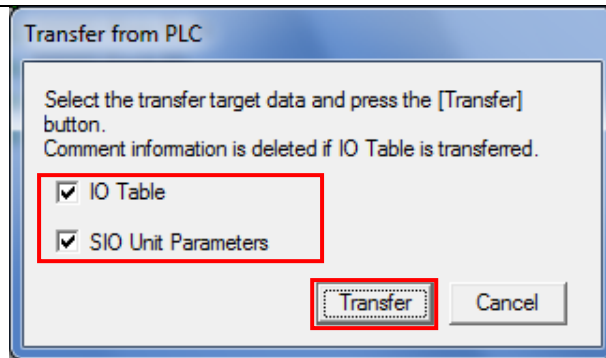

When the transfer is completed, the Transfer Results Dialog Box is displayed.

Check that the transfer is successfully completed by referring to the message in the dialog box.

When the I/O table is created normally, the dialog box displays as follows:

Transfer Success: 1 Unit

Transfer Unsuccessful: 0 Unit

Click **OK**.

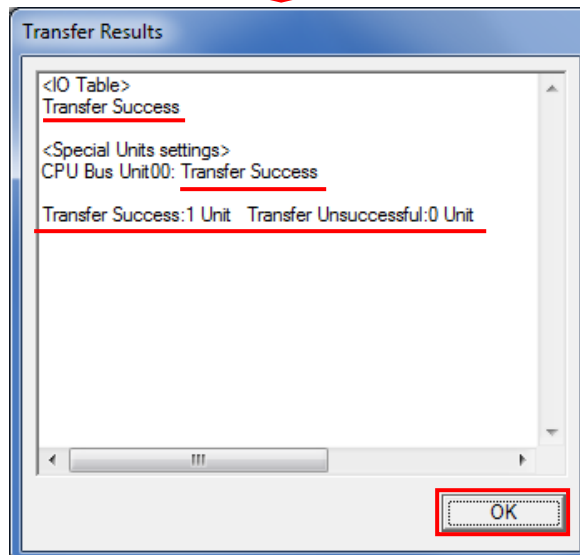

- 5 In the PLC IO Table Window, click + to the left of Built-in Port/Inner Board to display CJ2M-EIP21.

\*The figure on the right displays CPU Unit (Built-in EtherNet/IP port) specified in 5.2. *Device Configuration*. If you use an other applicable EtherNet/IP Unit, the display position and name are different from the figure on the right.

Right-click **CJ2M-EIP21** and select **Unit Setup**.

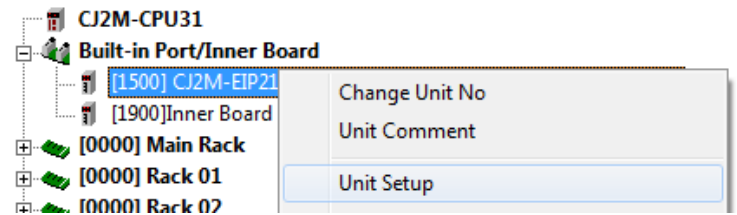
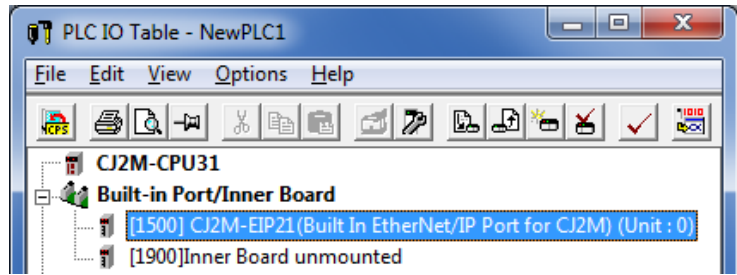

- 6 The Edit Parameters Dialog Box is displayed.

Select the **TCP/IP** Tab.

Make the following settings in the *IP Address* Field.

- Use the following address:  
*Select*
- IP address: 192.168.250.1
- Subnet mask: 255.255.255.0

Click **Transfer[PC to Unit]**.

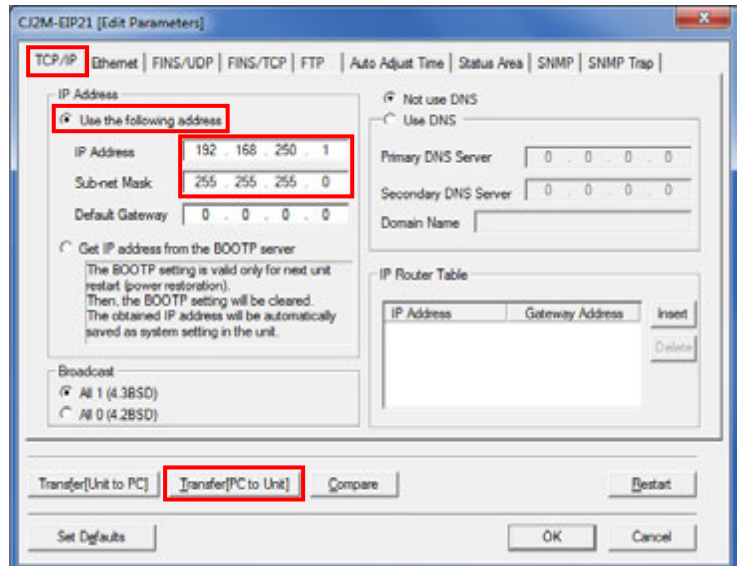

7 The dialog box on the right is displayed. Confirm that there is no problem, and click **Yes**.

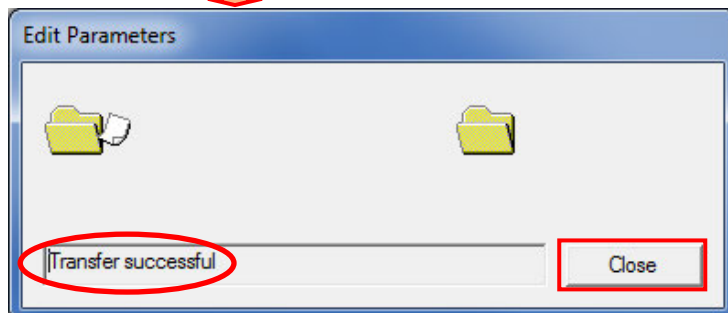
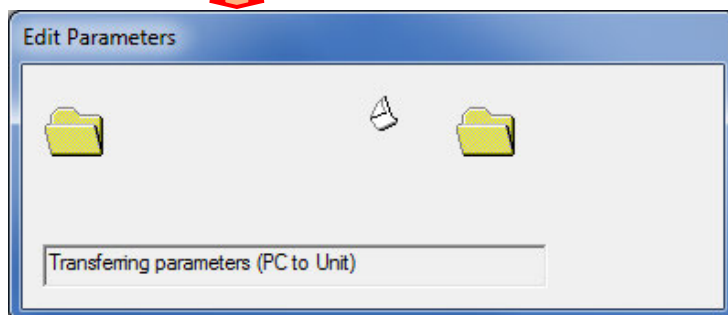
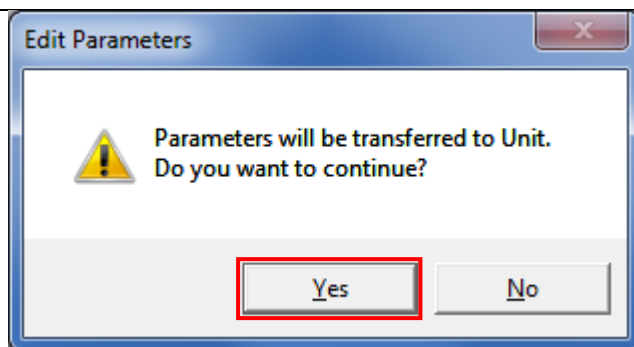

Check that a message is displayed stating "Transfer successful". Click **Close**.

8 The dialog box on the right is displayed. Check the contents and click **Yes**.

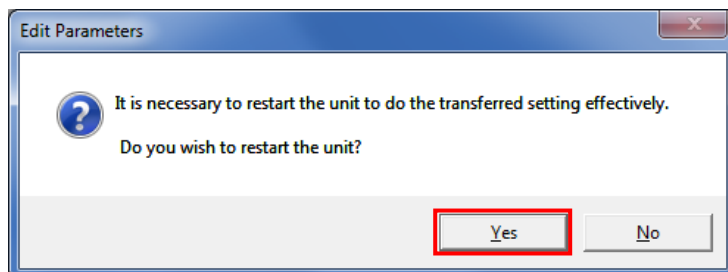

When the Unit is restarted, the dialog box on the right is displayed. Check the contents and click **OK**.

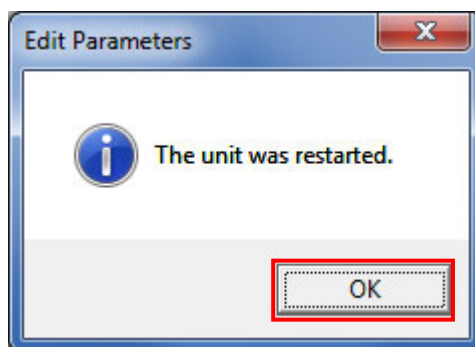

- 9 Click **Compare** to check that the IP address is correctly changed.

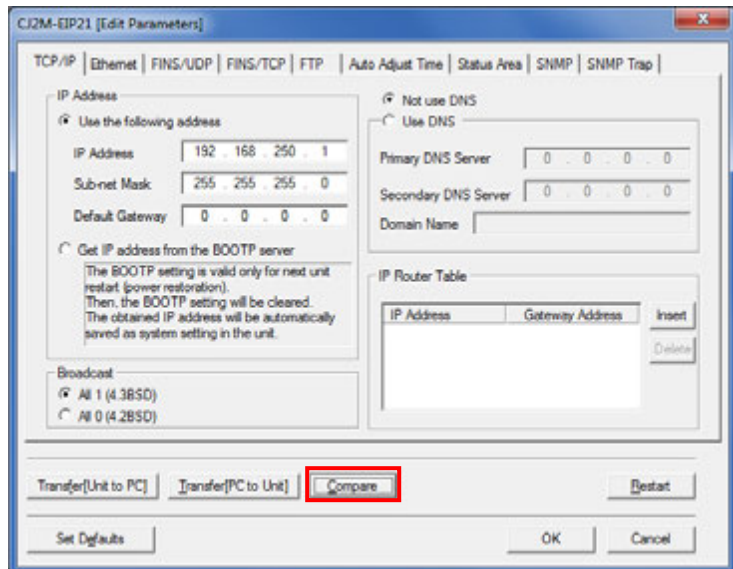

- 10 Check that a message is displayed stating "Compare successful". Click **Close**.

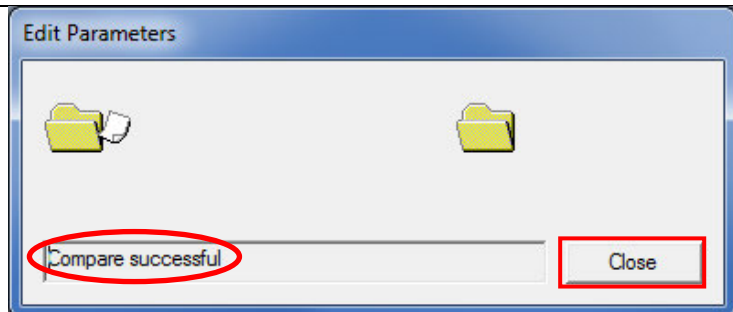

- 11 Click **OK** in the Edit Parameters Dialog Box.

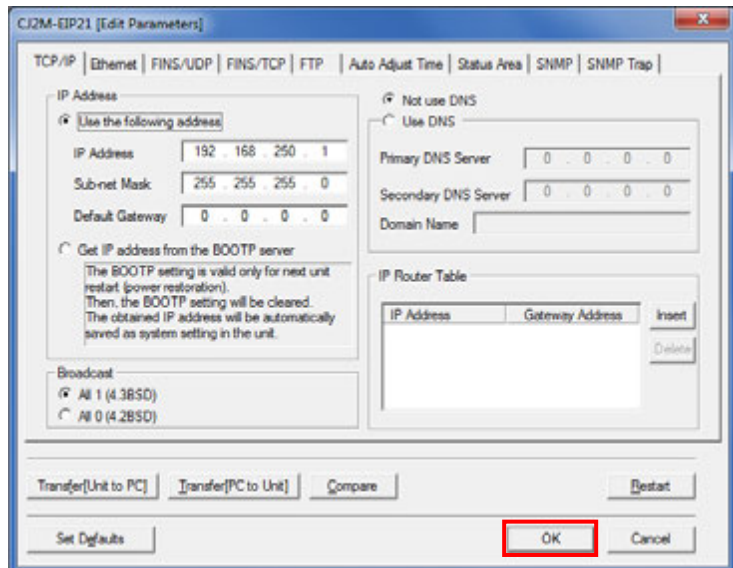

7.4. Network Settings

Set the EtherNet/IP tag data links.

7.4.1. Starting Network Configurator and Connecting Online with PLC

Start Network Configurator and connect online with PLC.

- 1 Right-click **CJ2M-EIP21** in the PLC IO Table Window, and select **Start Special Application - Start with Settings Inherited.**

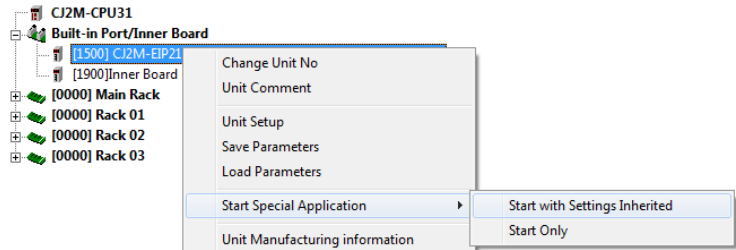

The Select Special Application Dialog Box is displayed. Select *Network Configurator* and click **OK**.

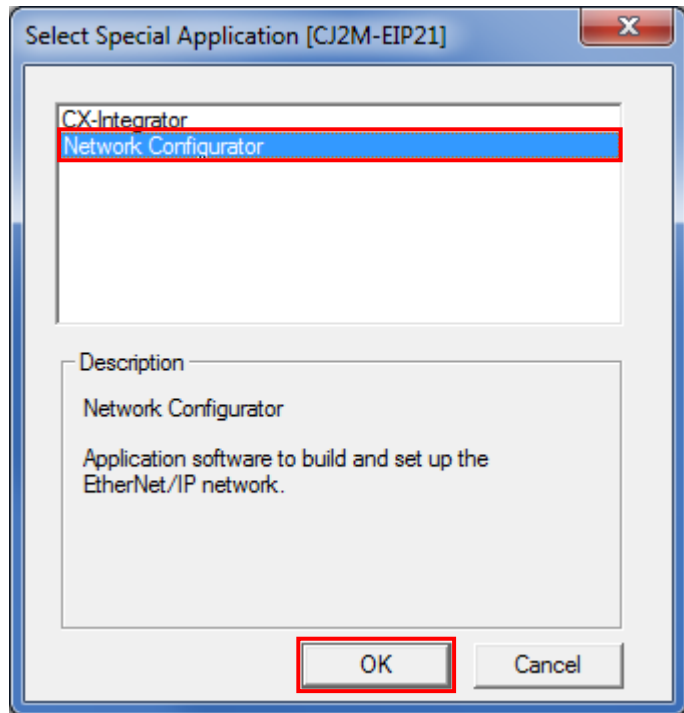

- 2 Network Configurator starts.

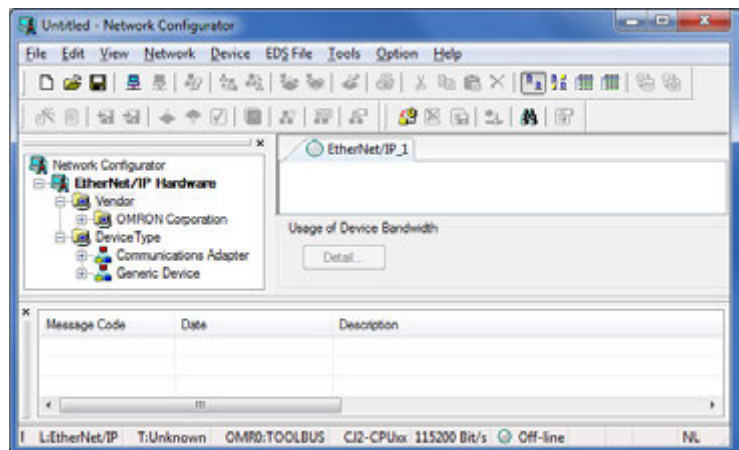



**Precautions for Correct Use**

Check that the LAN cables are connected before performing the following steps.  
If they are not connected, turn OFF each of the devices, and then connect the LAN cables.

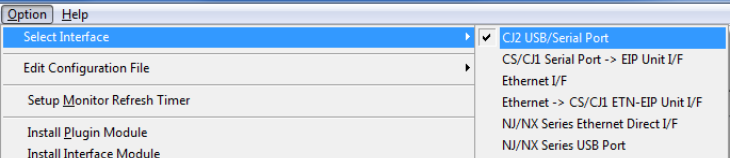
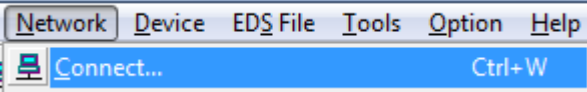
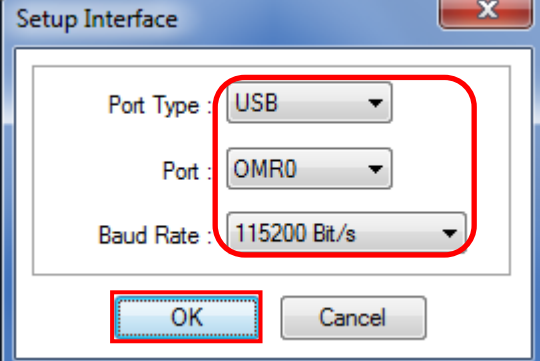
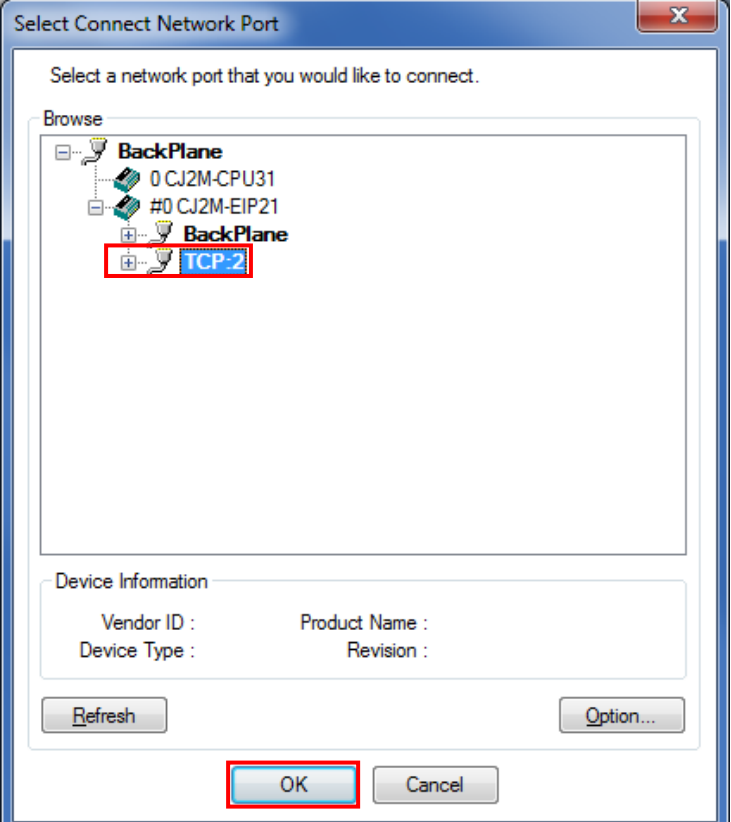
<p>3 Select <b>Select Interface - CJ2 USB/Serial Port</b> from the Option Menu.</p>	
<p>4 Select <b>Connect</b> from the Network Menu.</p>	
<p>5 The Setup Interface Dialog Box is displayed, Check that the following settings are made. Port Type: USB Port: OMR0 Baud Rate: 115200 Bit/s  Click <b>OK</b>.</p>	
<p>6 The Select Connect Network Port Dialog Box is displayed. Select <b>BackPlane - CJ2M-EIP21 - TCP:2</b>.  Click <b>OK</b>.</p>	

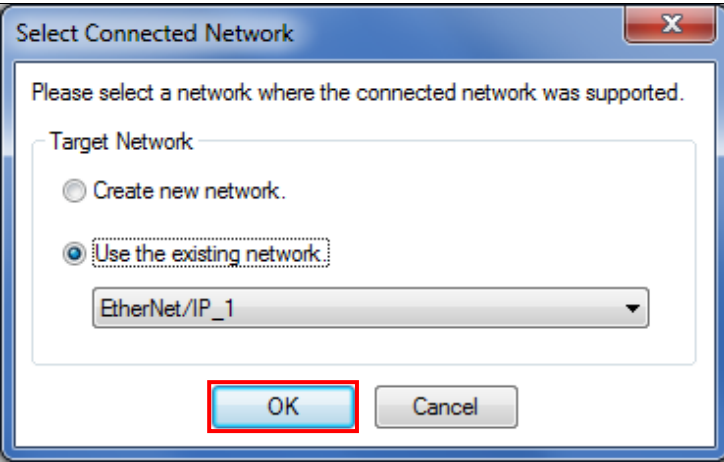
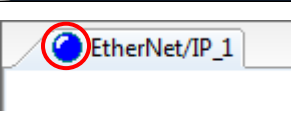
<p>7 The Select Connected Network Dialog Box is displayed. Check the contents and click <b>OK</b>.</p>	
<p>8 When an online connection is established normally, the color of the icon changes to blue as shown on the right.</p>	



#### Additional Information

If PLC cannot be connected online, check the cable connection.

Or, return to step 3, check the settings and repeat each step.

For details, refer to 6-2-9 *Connecting the Network Configurator to the Network* in SECTION 6 *Tag Data Link Functions of the EtherNet/IP™ Units OPERATION MANUAL* (Cat. No. W465).



## 7.4.2. Uploading the Network Configuration

Upload the network configuration.

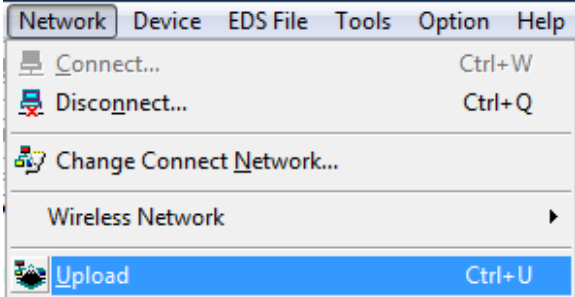
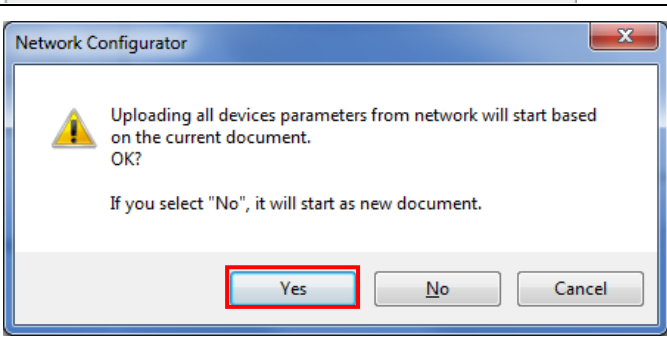
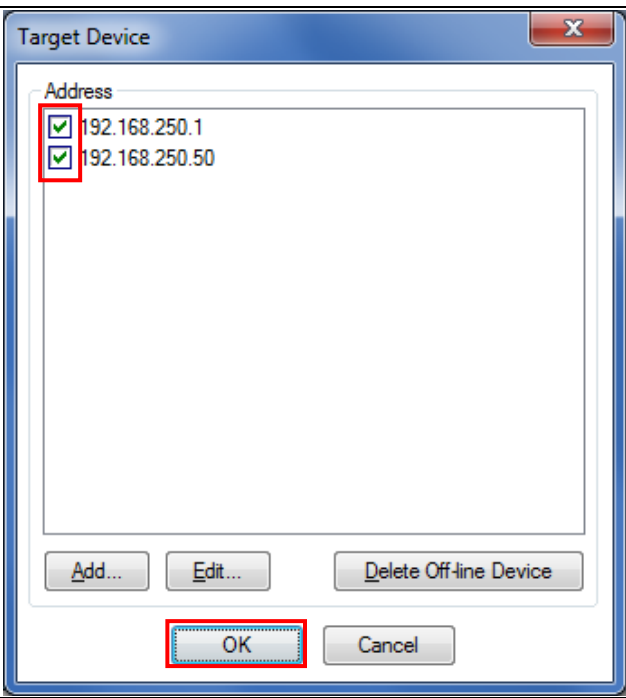
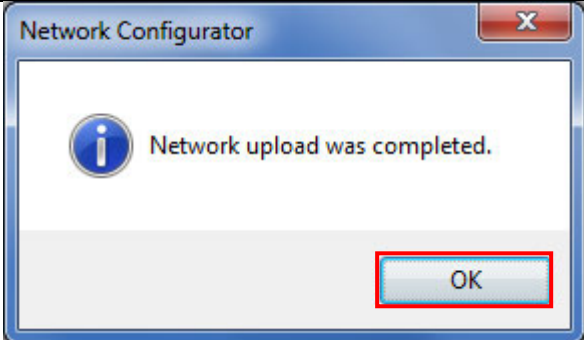
<p>1 Select <b>Upload</b> from the Network Menu to upload the device information on the network.</p>	
<p>2 The dialog box on the right is displayed. Confirm that there is no problem, and click <b>Yes</b>.</p>	
<p>3 The Target Device Dialog Box is displayed. Select <i>192.168.250.1</i> and <i>192.168.250.50</i>.</p> <p>Click <b>OK</b>.</p> <p>*If 192.168.250.1 and 192.168.250.50 are not displayed in the dialog box, click <b>Add</b> to add the addresses.</p> <p>*A displayed address depends on the status of Network Configurator.</p>	
<p>4 The device parameters are uploaded. When the uploading is completed, the dialog box on the right is displayed. Check the contents and click <b>OK</b>.</p>	

- 5 After uploading, check that the IP addresses of uploaded nodes are updated in the Network Configuration Pane as follows:

IP Address of node 1:

192.168.250.1

IP address of node 50:

192.168.250.50

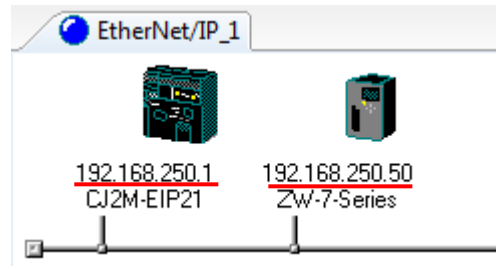

7.4.3. Setting the Tags

Register tags for input (consume) and output (produce).

The following explains the receive and send settings of the target device in order.

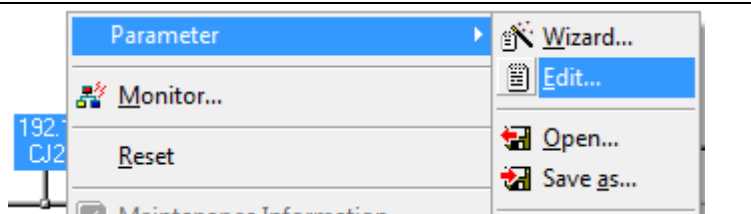
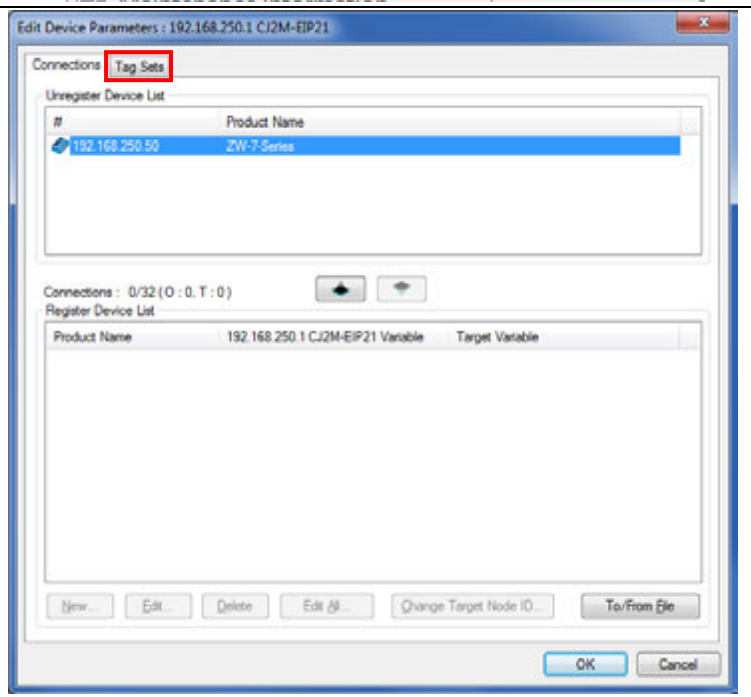
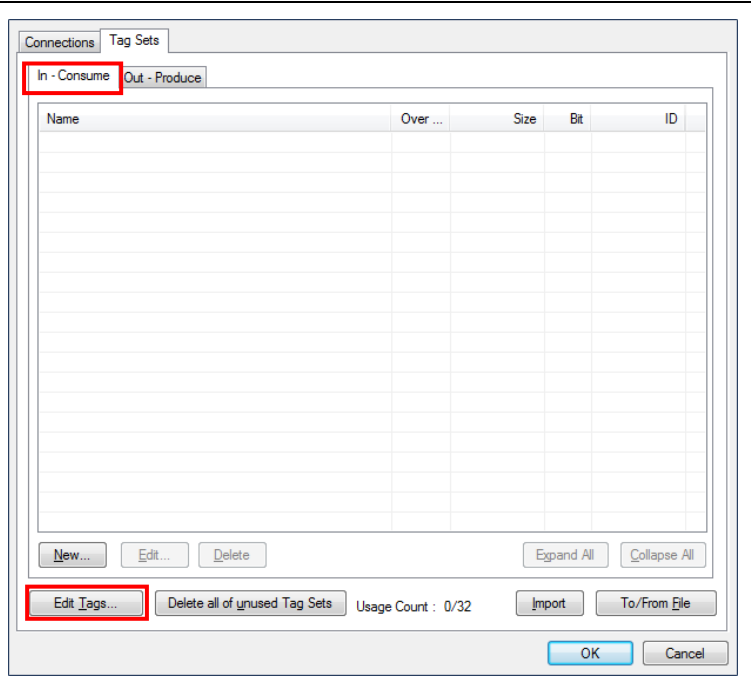
<p>1 In the Network Configuration Pane of Network Configurator, right-click the node 1 device and select <b>Parameter - Edit</b>.</p>	
<p>2 The Edit Device Parameters Dialog Box is displayed. Select the <b>Tag Sets</b> Tab.</p>	
<p>3 The data on the Tag Sets Tab Page is displayed. Select the <b>In-Consume</b> Tab and click <b>Edit Tags</b>.</p>	

- 4 The Edit Tags Dialog Box is displayed.  
 Select the **In - Consume** Tab and click **New**.  
 Here, register a tag for the area where the node 1 consumes data from the node 50.

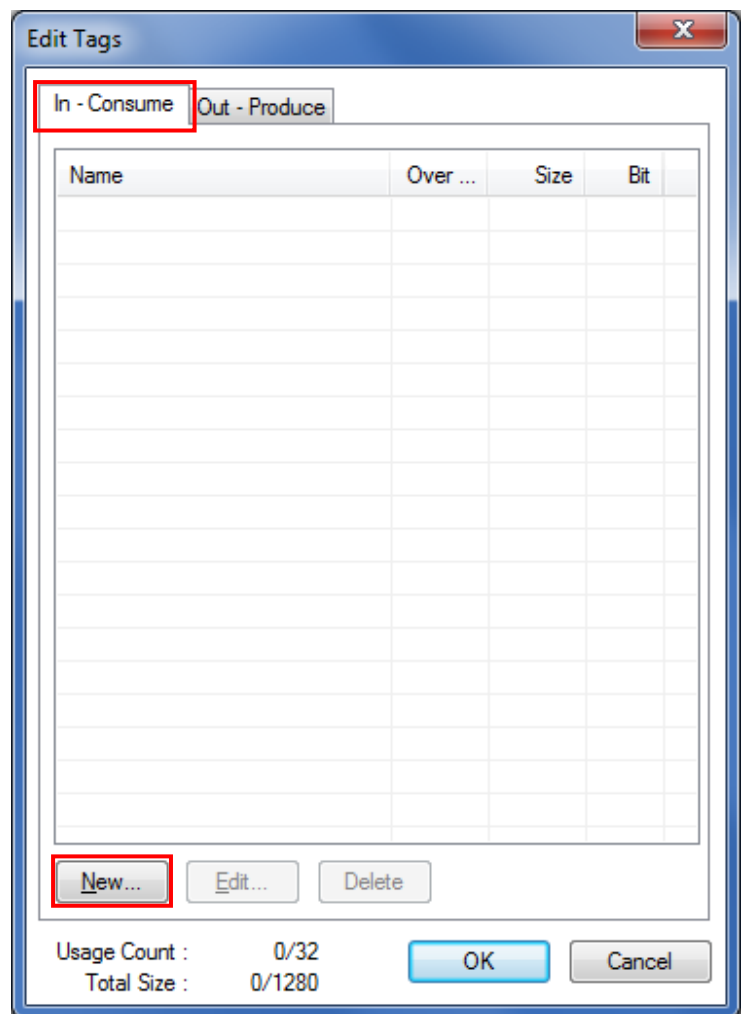

- 5 The Edit Tag Dialog Box is displayed. Enter the following values of the parameters.  
 Name: *D10100* (Start address of the input data to node 1)  
 Size: 56 (Byte)

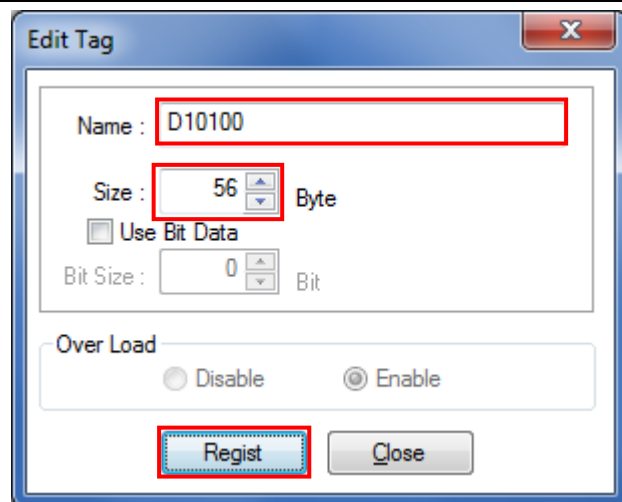

After entering, click **Regist**.

- 6 The Edit Tag Dialog Box is displayed again. Click **Close**.



- 7 Select the **Out - Produce** Tab and click **New**.  
Here, register a tag for the area where the node 1 produces data to the node 50.

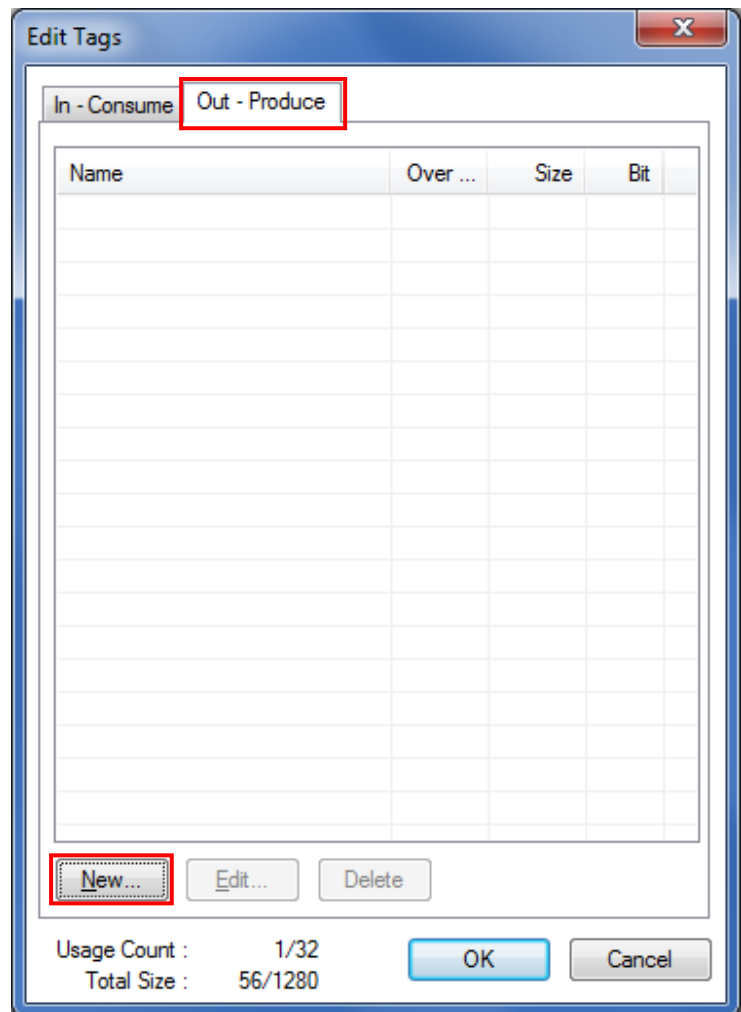

- 8 The Edit Tag Dialog Box is displayed. Enter the following values of the parameters.  
  
Name: *D10000* (Start address of the output data from node 1)  
Size: 24 (Byte)

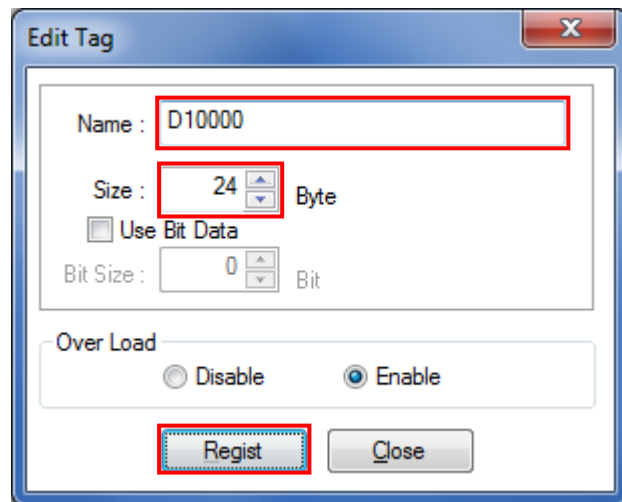

After entering, click **Regist**.

- 9 The Edit Tag Dialog Box is displayed again. Click **Close**.





- 12 The Edit Device Parameters Dialog Box is displayed again. Select the **Connections** Tab.

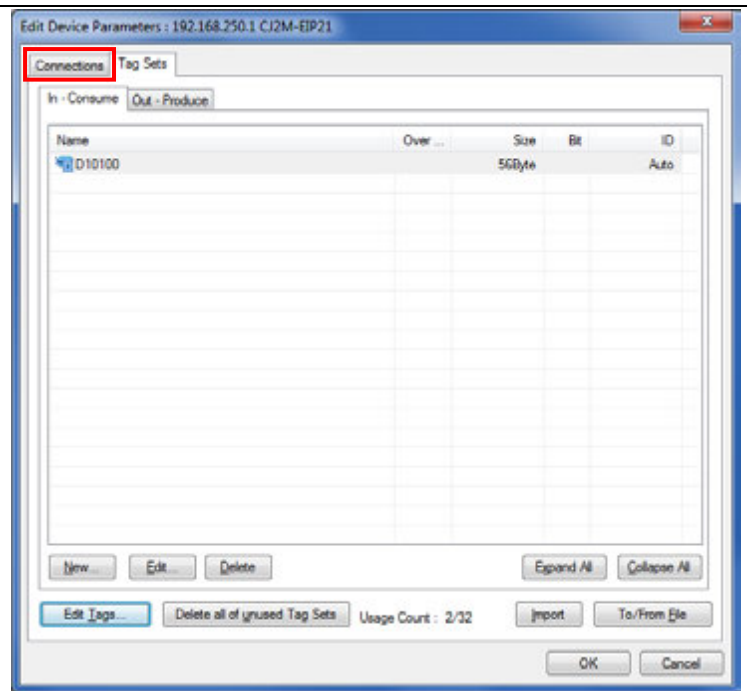

7.4.4. Setting the Connections

Associate the tags of the target device (that receives the open request) with the tags of the originator device (that requests for opening).

1 Select 192.168.250.50 in the *Unregister Device List* Field. Click the **Down Arrow** Button that is shown in the dialog box.

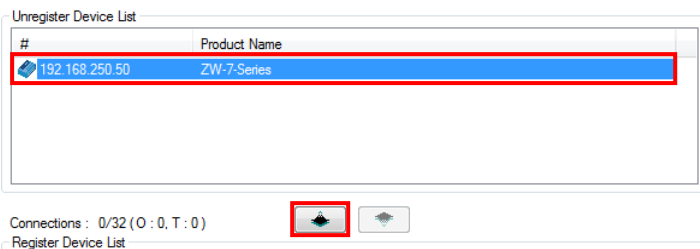

2 192.168.250.50 is registered in the *Register Device List* Field. Select 192.168.250.50 and click **New**.

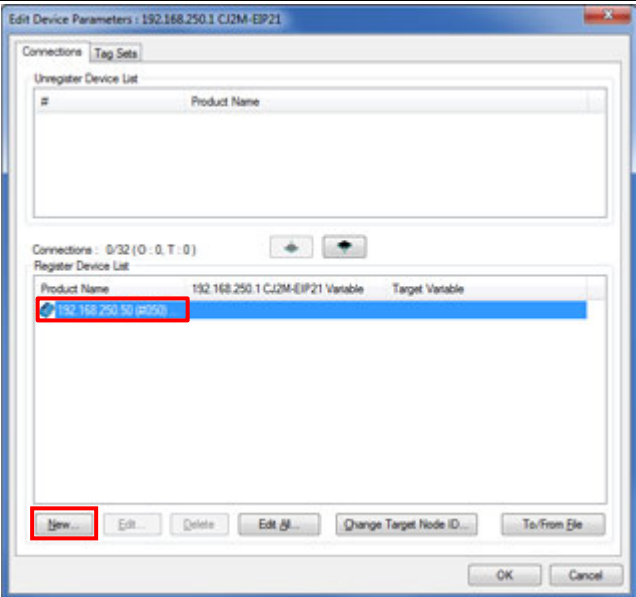

3 The Edit Connection Dialog Box is displayed. Check that Consume Data From/Produce Data To is selected from the pull-down list of Connection I/O Type. Set the values listed in the following table in the *Originator Device* and the *Target Device* Fields.

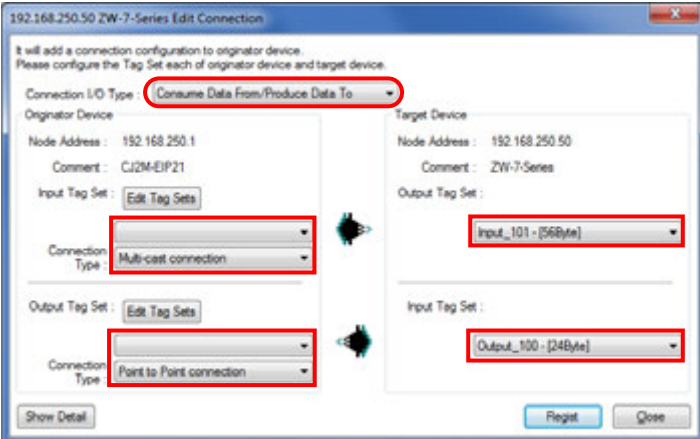

■ Connection configuration settings

Connection configuration		Set value
Connection I/O Type		Consume Data From /Produce Data To
Originator Device	Input Tag Set	D10100-[56 Byte]
	Connection Type	Multi-cast connection
	Output Tag Set	D10000-[24 Byte]
Target Device	Connection Type	Point to Point connection
	Output Tag Set	Input_101-[56 Byte]
	Input Tag Set	Output_100-[24 Byte]



- 4 Check that the settings are correct.  
Click **Regist**.



- 5 The Edit Connection Dialog Box is displayed again. Click **Close**.



- 6 The Edit Device Parameters Dialog Box is displayed again. Click **OK**.

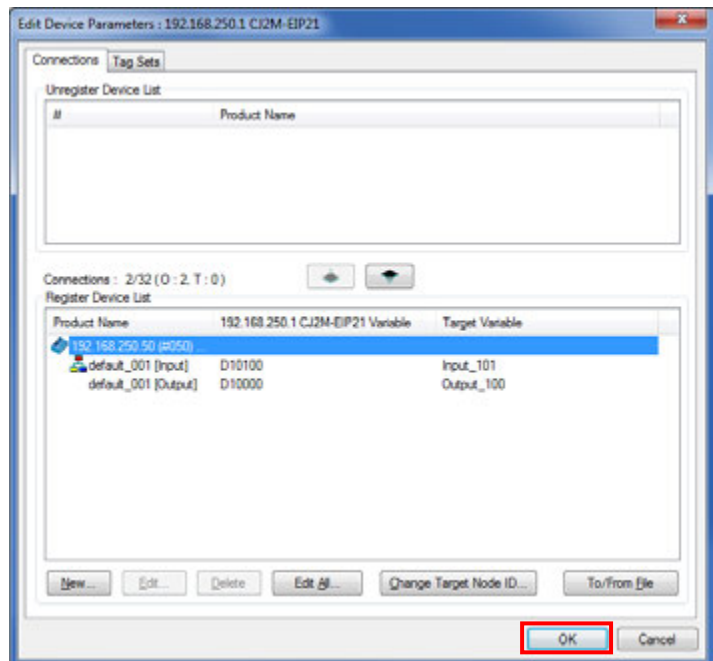

- 7 When the connection is completed, the registered node address is displayed under the device icon of node 50 in the Network Configuration Pane.

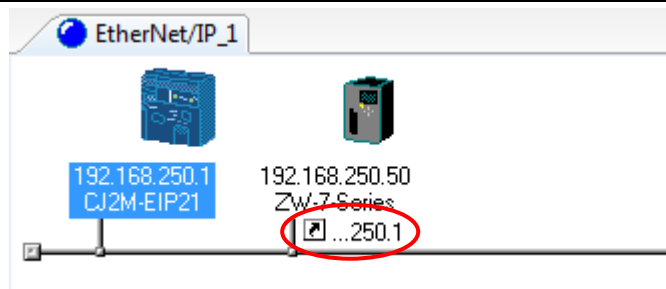

## 7.4.5. Transferring the Tag Data Link Parameters

Transfer the set tag data link parameters to PLC.

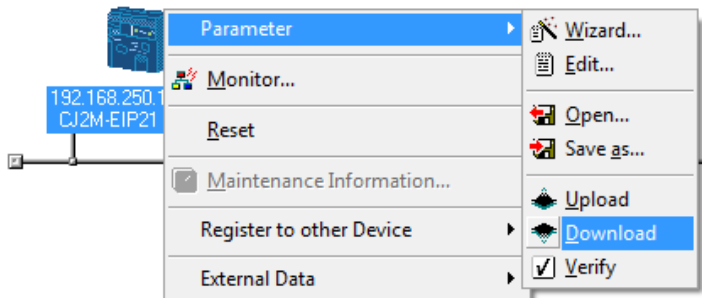
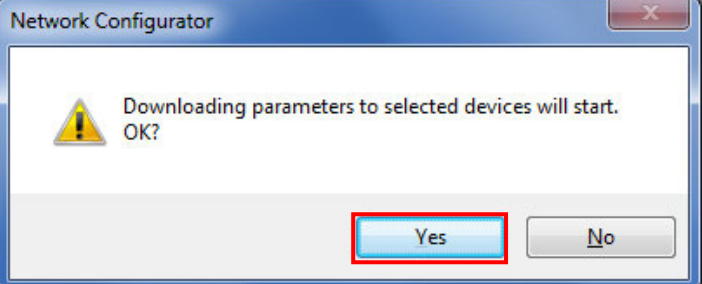
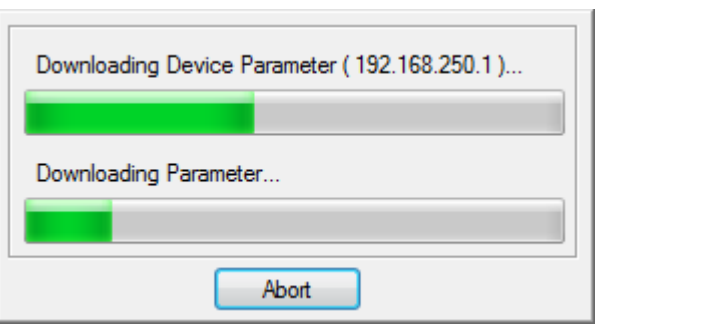
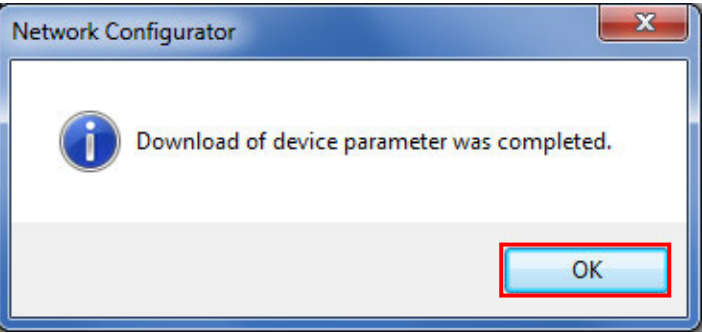
<p>1 Right-click the device icon of node 1 in the Network Configuration Pane and select <b>Parameter - Download</b>.</p>	
<p>2 The dialog box on the right is displayed. Confirm that there is no problem, and click <b>Yes</b>.</p>	
<p>3 The tag data link parameters are downloaded from Network Configurator to PLC.</p>	
<p>4 The dialog box on the right is displayed. Check the contents and click <b>OK</b>.</p>	

## 7.5. EtherNet/IP Communication Status Check

Confirm that the EtherNet/IP tag data links operate normally.

### 7.5.1. Checking the Connection Status

Check the connection status of the EtherNet/IP network.

- 1 Check with LED indicators on PLC (EtherNet/IP Unit) that the EtherNet/IP tag data links operate normally.

The LED indicators in normal status are as follows:

MS: Green lit

NS: Green lit

COMM: Yellow lit

100M or 10M: Yellow lit



- 2 Check the LED indicators on Sensor Controller.

The LED indicators in normal status are as follows:

Red LED: Lighting

Green LED: Lighting

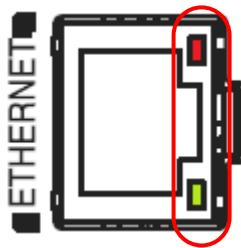

- 3 The normal operation of tag data links is confirmed through the status information in the Monitor Device Dialog Box of Network Configurator.

Right-click the device icon of node 1 in the Network Configuration Pane and select **Monitor**.

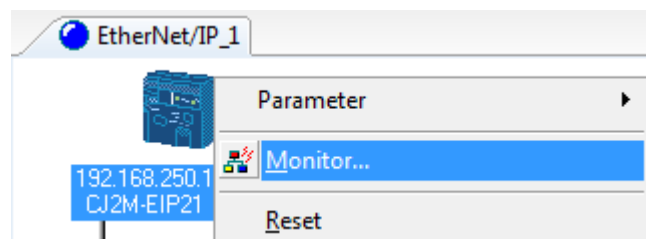

- 4 The dialog box on the right displays the Status 1 Tab Page in the Monitor Device Dialog Box.

When the same check boxes are selected as shown on the right, the tag data links are normally in operation.

Click **Close**.

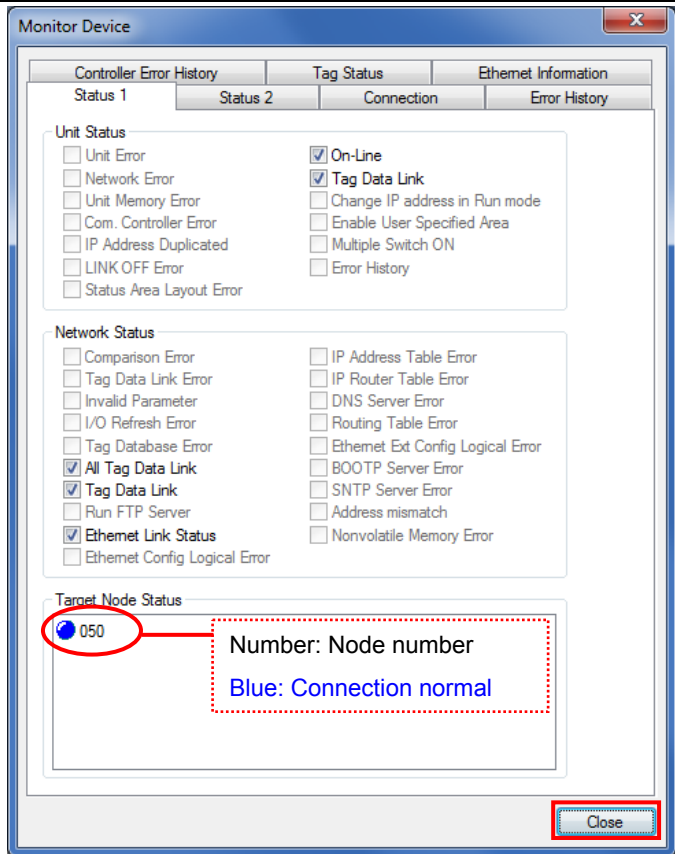

- 5 Select **Disconnect** from the Network Menu to go offline.

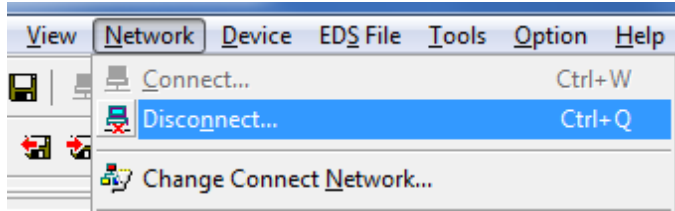

- 6 The color of the icon changes from blue to gray as shown on the right.

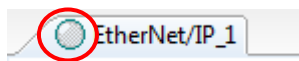

- 7 Select **Exit** from the File Menu to close Network Configurator.

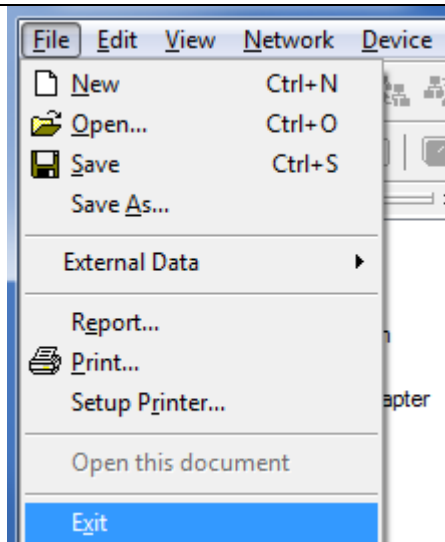

7.5.2. Checking the Sent and Received Data

Check that the correct data are sent and received.

**Caution**

If the PLC memory is changed by malfunction during monitoring power flow and present value status in the Ladder Section Window or in the Watch Window, the devices connected to output units may malfunction, regardless of the operating mode of CPU Unit.

Always ensure safety before monitoring power flow and present value status in the Ladder Section Window or in the Watch Window.

- 1 Check that the operating mode of PLC is in Stop/Program Mode.

\*If the PLC is not in Stop/Program Mode, change to Stop/Program Mode by referring to *step 1* of 7.3.3. *Creating the I/O Table and setting IP Address.*

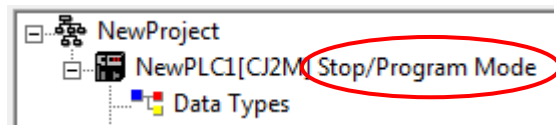

- 2 Select **Edit - Memory** from the PLC Menu.

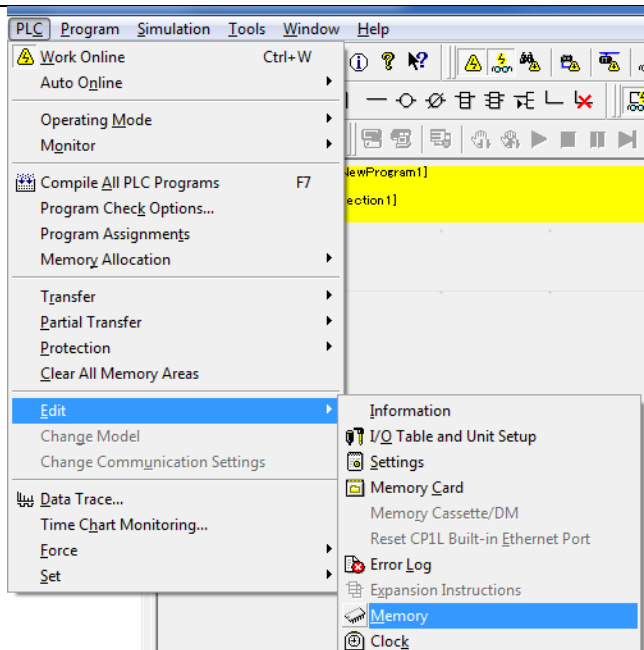

- 3 The PLC Memory Window is displayed. Double-click **D** on the **Memory Tab** of the PLC Memory Window.

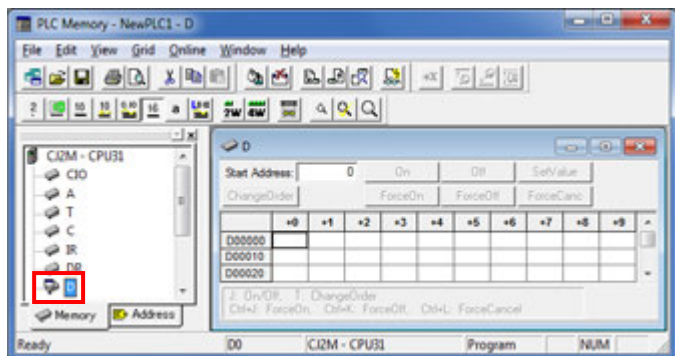

- 4 Select **Display - Hexadecimal** from the View Menu.

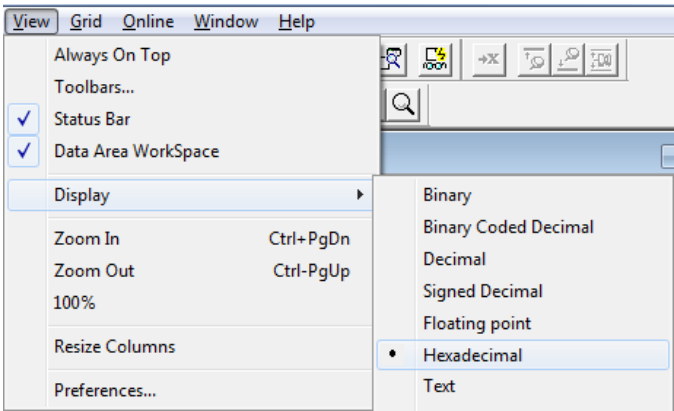

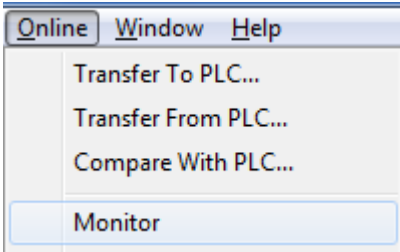
- 5 Select **Monitor** from the Online Menu.

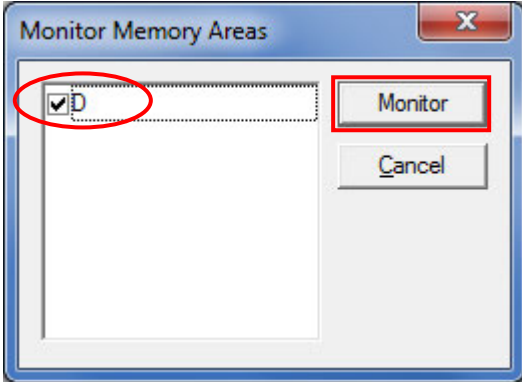
- 6 The Monitor Memory Areas Dialog Box is displayed. Check that D is selected. Click **Monitor**.

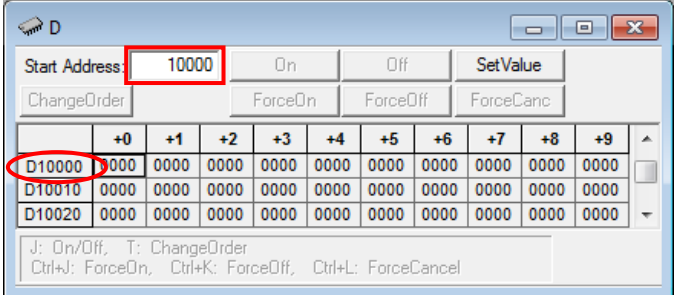
- 7 Enter 10000 in the Start Address Field of the D Window. Check that the start address changes to D10000.

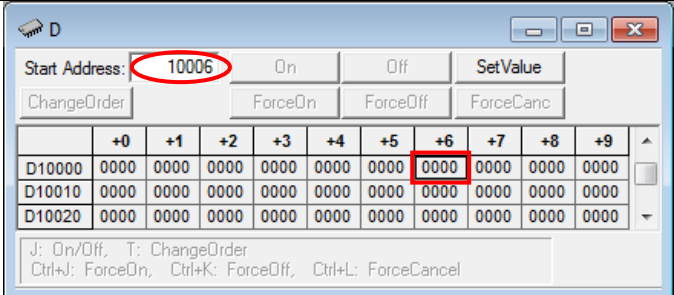

	+0	+1	+2	+3	+4	+5	+6	+7	+8	+9
D10000	0000	0000	0000	0000	0000	0000	0000	0000	0000	0000
D10010	0000	0000	0000	0000	0000	0000	0000	0000	0000	0000
D10020	0000	0000	0000	0000	0000	0000	0000	0000	0000	0000
- 8 Select the value of +6 (D10006) in the D10000 Row of the D Window. Check that the value in the Start Address Field changes to 10006.



	+0	+1	+2	+3	+4	+5	+6	+7	+8	+9
D10000	0000	0000	0000	0000	0000	0000	0000	0000	0000	0000
D10010	0000	0000	0000	0000	0000	0000	0000	0000	0000	0000
D10020	0000	0000	0000	0000	0000	0000	0000	0000	0000	0000

9 Click **SetValue**.



The Set Value Dialog Box is displayed.

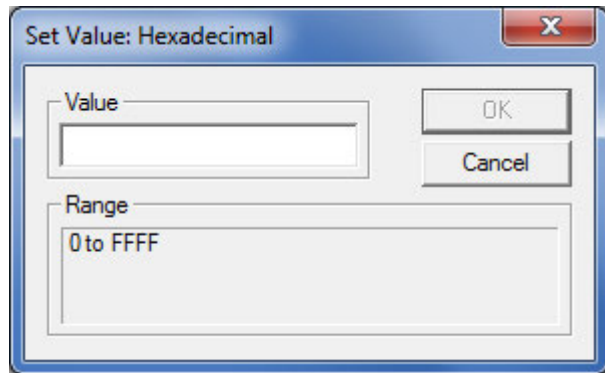

10 Enter **4000** in the *Value* Field. Click **OK**.

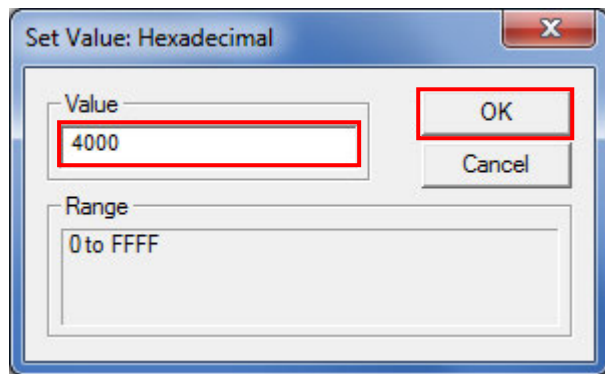

The value of D10006 changes to 4000.

Start Address:	10006	On	Off	SetValue						
ChangeOrder		ForceOn	ForceOff	ForceCanc						
	+0	+1	+2	+3	+4	+5	+6	+7	+8	+9
D10000	0000	0000	0000	0000	0000	0000	4000	0000	0000	0000

11 In the same way as step 10, change the value of D10007 to 0040.

\*The command code 4000 0040 (system data acquisition) is set.

Start Address:	10007	On	Off	SetValue						
ChangeOrder		ForceOn	ForceOff	ForceCanc						
	+0	+1	+2	+3	+4	+5	+6	+7	+8	+9
D10000	0000	0000	0000	0000	0000	0000	4000	0040	0000	0000

12 Select **Display - Decimal** from the View Menu.

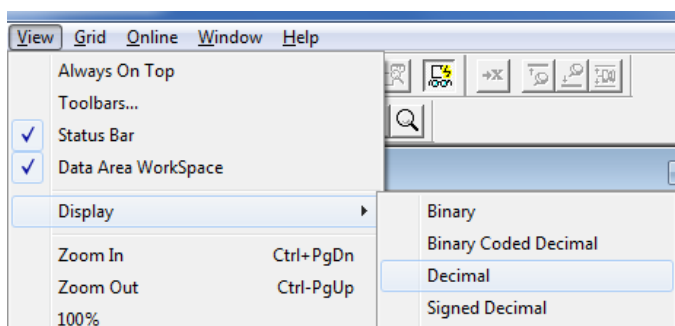

13 In the same way as steps 8 to 10, change the value of D10008 to 900.

\*The system data number 900 (number of digits displayed past decimal point) is set.

Start Address:	10008	On	Off	SetValue						
ChangeOrder		ForceOn	ForceOff	ForceCanc						
	+0	+1	+2	+3	+4	+5	+6	+7	+8	+9
D10000	0	0	0	0	0	0	16384	64	900	0

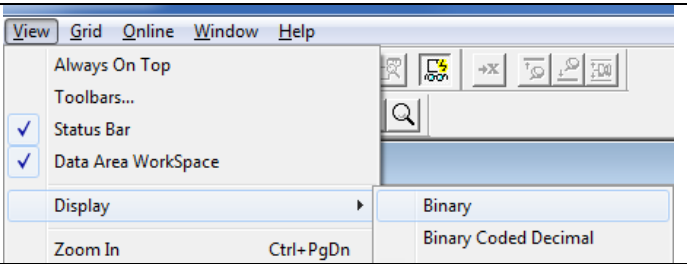
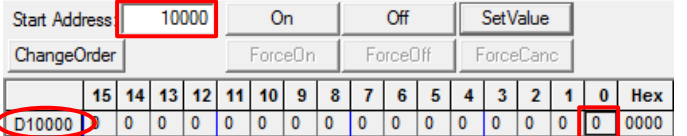
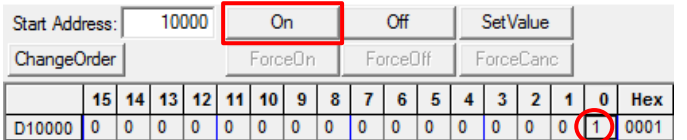
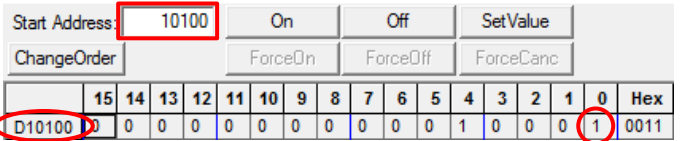
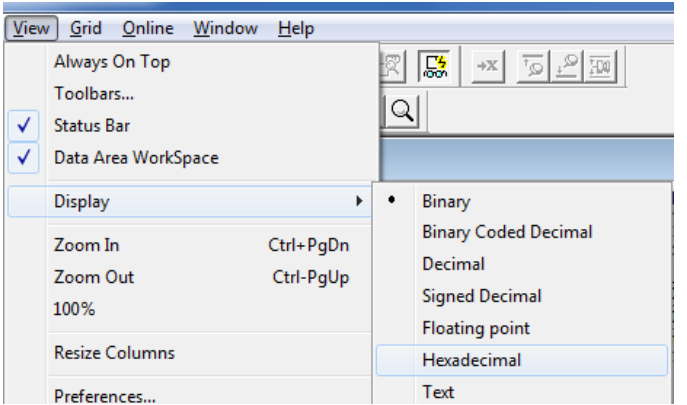
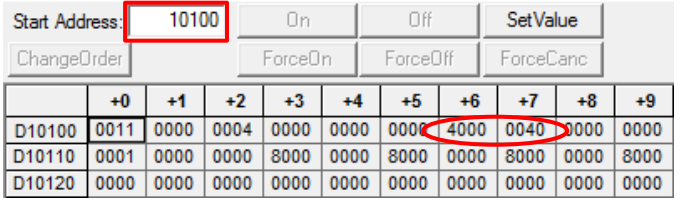
- 14 Select **Display - Binary** from the View Menu.
- 
- 15 Enter 10000 in the *Start Address* Field of the D Window.
- Check that the start address changes to D10000.
- Select the bit 0 value of D10000 in the D Window.
- 
- 16 Click **On**.
- The bit 0 value of D10000 changes to 1.
- \*D10000 Bit 0: Control command execution
- 
- 17 Enter 10100 in the *Start Address* Field of the D Window.
- Check that the start address changes to D10100 and that the bit 0 value of D10100 is 1.
- \*D10100 Bit 0: Control command completion
- 
- 18 Select **Display - Hexadecimal** from the View Menu.
- 
- 19 Check that the values of D10106 and D10107 show the command values set in steps 10 and 11, respectively.
- \*D10106, D10107: Command code echo
- 



20 Check that the values of D10108 and D10109 are both 0.

\*D10108, D10109: Response code (Command execution result (0: OK, -1(FFFF FFFF): NG) is reflected.)

先頭チャンネル:	10100		セット	リセット	現在値設定					
ビット順変更			強制セット	強制リセット	強制解除					
	+0	+1	+2	+3	+4	+5	+6	+7	+8	+9
D10100	0011	0000	0110	0020	0000	0000	4000	0040	0000	0000
D10110	0001	0000	7484	0000	0000	8000	0000	8000	0000	8000
D10120	0000	0000	0000	0000	0000	0000	0000	0000	0000	0000

21 Check that the value of D10110 is 1.

\*D10110: Response data (lower 16 bits)  
(The number of digits displayed past decimal point is 1 (default).)

Start Address:	10100		On	Off	SetValue					
ChangeOrder			ForceOn	ForceOff	ForceCanc					
	+0	+1	+2	+3	+4	+5	+6	+7	+8	+9
D10100	0011	0000	0004	0000	0000	0000	4000	0040	0000	0000
D10110	0001	0000	0000	8000	0000	8000	0000	8000	0000	8000
D10120	0000	0000	0000	0000	0000	0000	0000	0000	0000	0000



**Additional Information**

For details on commands, refer to 4-1 EtherNet/IP Connection of the *Displacement Sensor ZW-7000 series Confocal Fiber Type Displacement Sensor User's Manual for Communications Settings* (Cat. No. Z363).



**Additional Information**

For details on system data, refer to 8-2 System data list of the *Displacement Sensor ZW-7000 series Confocal Fiber Type Displacement Sensor User's Manual for Communications Settings* (Cat. No. Z363).

## 8. Initialization method

The setting procedures in this document are based on the factory default settings. Some settings may not be applicable unless you use the devices with the factory default settings.

### 8.1. Initializing PLC

To initialize the PLC settings, it is necessary to initialize EtherNet/IP Unit and CPU Unit. Change the operating mode of PLC to PROGRAM mode before the initialization.

#### 8.1.1. EtherNet/IP Unit

To initialize the EtherNet/IP Unit settings, select **Edit - I/O Table and Unit Setup** from the PLC Menu in CX-Programmer, and follow the steps below.

(1) Right-click EtherNet/IP Unit in the PLC IO Table Window and select **Unit Setup** from the menu.

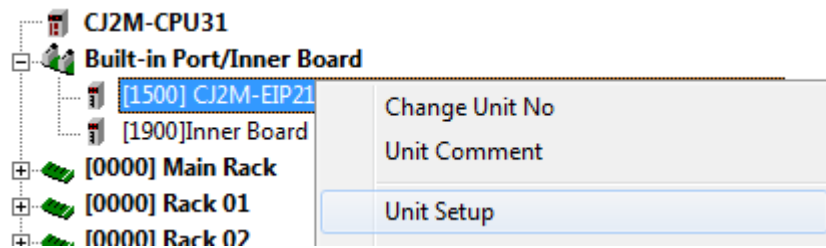

(2) Click **Restart** in the Edit Parameters Dialog Box.

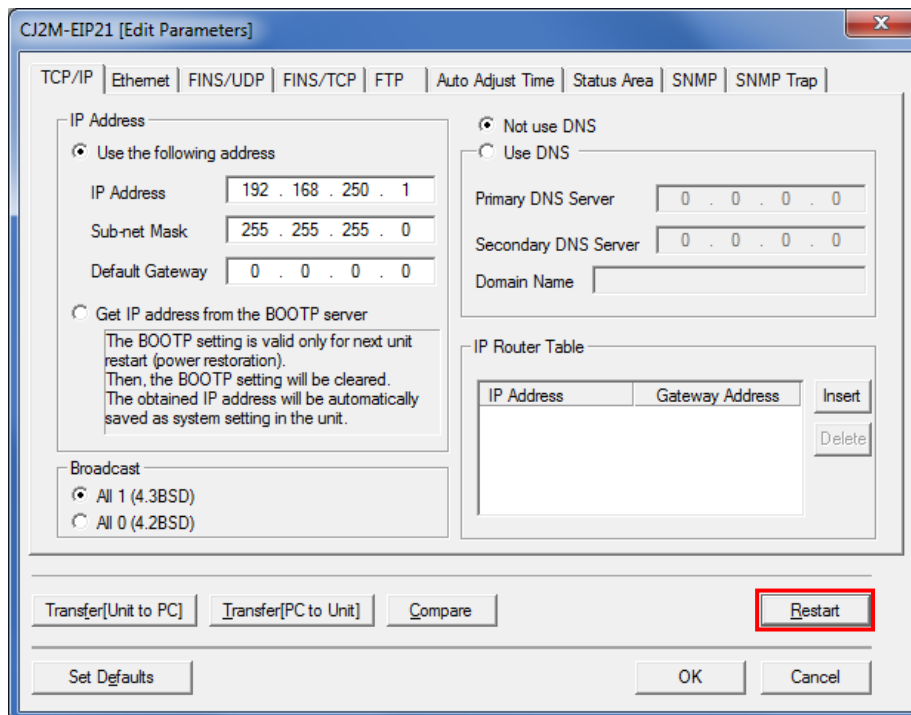

(3) An execution confirmation dialog box is displayed. Confirm that there is no problem, and click **Yes**.

(4)The Restart Unit Dialog Box is displayed. Select *Return to out-of-box configuration, and then emulate cycling power*, and click **OK**.

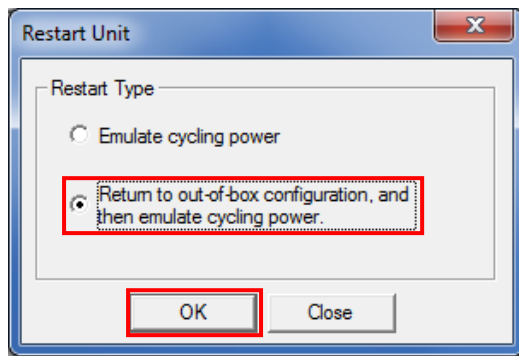

(5)A dialog box is displayed indicating that the execution is completed. Check the contents and click **OK**.

### 8.1.2. CPU Unit

To initialize the CPU Unit settings, select **Clear All Memory Areas** from the PLC Menu in CX-Programmer. Select *Initialize* in the Confirm All Memory Area Clear Dialog Box and click **OK**.

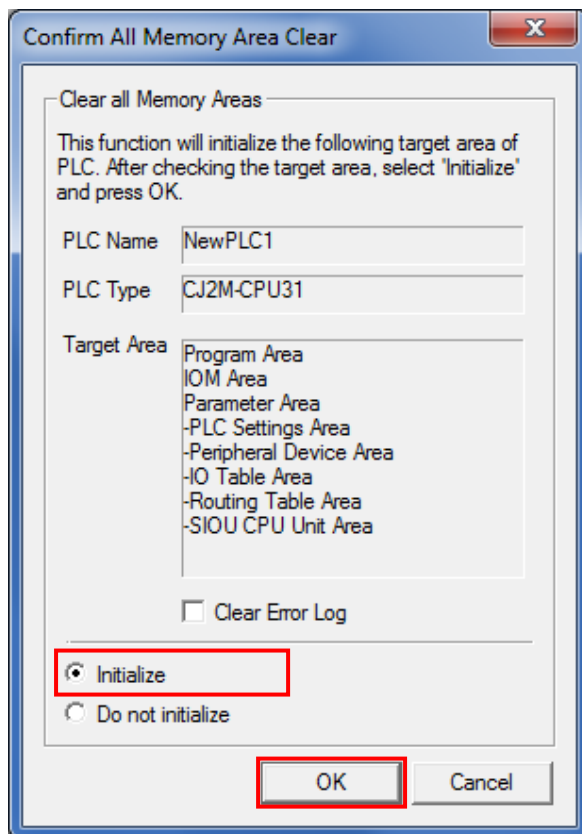

## 8.2. Initializing Sensor Controller

For information on how to initialize Sensor Controller, refer to *Initializing Settings in 8-11 Setting the System in 8. Sensor controller operations of the Displacement Sensor ZW-7000 series Confocal Fiber Type Displacement Sensor User's Manual (Cat. No. Z362)*.

## 9. Revision History

Revision code	Date of revision	Description of revision
01	July 7, 2016	First edition



**OMRON Corporation Industrial Automation Company**

Tokyo, JAPAN

Contact: [www.ia.omron.com](http://www.ia.omron.com)

**Regional Headquarters**

**OMRON EUROPE B.V.**

Wegalaan 67-69, 2132 JD Hoofddorp  
The Netherlands  
Tel: (31)2356-81-300/Fax: (31)2356-81-388

**OMRON ELECTRONICS LLC**

2895 Greenspoint Parkway, Suite 200  
Hoffman Estates, IL 60169 U.S.A  
Tel: (1) 847-843-7900/Fax: (1) 847-843-7787

**OMRON ASIA PACIFIC PTE. LTD.**

No. 438A Alexandra Road # 05-05/08 (Lobby 2),  
Alexandra Technopark,  
Singapore 119967  
Tel: (65) 6835-3011/Fax: (65) 6835-2711

**OMRON (CHINA) CO., LTD.**

Room 2211, Bank of China Tower,  
200 Yin Cheng Zhong Road,  
PuDong New Area, Shanghai, 200120, China  
Tel: (86) 21-5037-2222/Fax: (86) 21-5037-2200

**Authorized Distributor:**

© OMRON Corporation 2016 All Rights Reserved.  
In the interest of product improvement,  
specifications are subject to change without notice.

**Cat. No. P661-E1-01**

0716-(-)