

Machine Automation Controller NJ/NX-series

Troubleshooting Manual

NX701-1□□□

NX502-1□□□

NX102-1□□□

NX102-9□□□

NX1P2-1□□□□□

NX1P2-9□□□□□

NJ501-□□□□

NJ301-1□□□

NJ101-10□□

NJ101-90□□

NOTE

1. All rights reserved. No part of this publication may be reproduced, stored in a retrieval system, or transmitted, in any form, or by any means, mechanical, electronic, photocopying, recording, or otherwise, without the prior written permission of OMRON.
2. No patent liability is assumed with respect to the use of the information contained herein. Moreover, because OMRON is constantly striving to improve its high-quality products, the information contained in this manual is subject to change without notice.
3. Every precaution has been taken in the preparation of this manual. Nevertheless, OMRON assumes no responsibility for errors or omissions. Neither is any liability assumed for damages resulting from the use of the information contained in this publication.

Trademarks

- Sysmac and SYSMAC are trademarks or registered trademarks of OMRON Corporation in Japan and other countries for OMRON factory automation products.
- Microsoft, Windows, Excel, Visual Basic, and Microsoft Edge are either registered trademarks or trademarks of Microsoft Corporation in the United States and other countries.
- EtherCAT® is registered trademark and patented technology, licensed by Beckhoff Automation GmbH, Germany.
- ODVA, CIP, CompoNet, DeviceNet, and EtherNet/IP are trademarks of ODVA.
- The SD and SDHC logos are trademarks of SD-3C, LLC. 

Other company names and product names in this document are the trademarks or registered trademarks of their respective companies.

Copyrights

- Microsoft product screen shots used with permission from Microsoft.
- This product incorporates certain third party software. The license and copyright information associated with this software is available at http://www.fa.omron.co.jp/nj_info_e/.

Introduction

Thank you for purchasing an NJ/NX-series CPU Unit.

This manual contains information that is necessary to use the NJ/NX-series CPU Unit. Please read this manual and make sure you understand the functionality and performance of the NJ/NX-series CPU Unit before you attempt to use it in a control system.

Keep this manual in a safe place where it will be available for reference during operation.

Intended Audience

This manual is intended for the following personnel, who must also have knowledge of electrical systems (an electrical engineer or the equivalent).

- Personnel in charge of introducing FA systems.
- Personnel in charge of designing FA systems.
- Personnel in charge of installing and maintaining FA systems.
- Personnel in charge of managing FA systems and facilities.

For programming, this manual is intended for personnel who understand the programming language specifications in international standard IEC 61131-3 or Japanese standard JIS B 3503.

Applicable Products

This manual covers the following products.

- NX-series CPU Units
 - NX701-1□□□
 - NX502-1□□□
 - NX102-1□□□
 - NX102-9□□□
 - NX1P2-1□□□□□
 - NX1P2-9□□□□□
- NJ-series CPU Units
 - NJ501-□□□□
 - NJ301-1□□□
 - NJ101-10□□
 - NJ101-90□□

Part of the specifications and restrictions for the CPU Units are given in other manuals. Refer to *Relevant Manuals* on page 2 and *Related Manuals* on page 19.

Purpose of use	Manual										
	Basic information										
	NJ/NX-series Troubleshooting Manual	NJ/NY-series NC Integrated Controller User's Manual	NJ-series NJ Robotics CPU Unit User's Manual	NJ-series Robot Integrated CPU Unit User's Manual	NJ-series SECS/GEM CPU Units User's Manual	NJ/NX-series Database Connection CPU Units User's Manual	NX-series CPU Unit FINS User's Manual	NJ/NX-series CPU Unit OPC UA User's Manual	NJ/NX-series CPU Unit Built-in EtherNet/IP Port User's Manual	NJ/NX-series CPU Unit Built-in EtherCAT Port User's Manual	NJ/NX-series Motion Control Instructions Reference Manual
Software settings											
Using motion control											○
Using EtherCAT									○		
Using EtherNet/IP								○			
Using OPC UA							○				
Using FINS						○					
Using the database connection service					○						
Using the GEM Services						○					
Using robot control for OMRON robots										○	
Using robot control by NJ Robotics function											○
Using numerical control											○
Using the NX1P2 CPU Unit functions										○	
Writing the user program											
Using motion control										○	○
Using EtherCAT									○		
Using EtherNet/IP								○			
Using OPC UA									○		
Using FINS										○	
Using the database connection service						○					
Using the GEM Services										○	
Using robot control for OMRON robots											○
Using robot control by NJ Robotics function											○
Using numerical control											○
Programming error processing											○
Using the NX1P2 CPU Unit functions										○	

Purpose of use	Manual													
	Basic information					NJ/NX-series Motion Control Instructions Reference Manual	NJ/NX-series Motion Control User's Manual	NJ/NX-series CPU Unit	NJ/NX-series CPU Unit	NJ/NX-series CPU Unit	NJ/NX-series CPU Unit	NJ/NX-series CPU Unit	NJ/NX-series CPU Unit	NJ/NX-series CPU Unit
	NJ/NX-series CPU Unit Software User's Manual	NJ-series CPU Unit Hardware User's Manual	NX-series NX1P2 CPU Unit Hardware User's Manual	NX-series NX102 CPU Unit Hardware User's Manual	NX-series NX502 CPU Unit Hardware User's Manual									
Testing operation and debugging														
Using motion control														
Using EtherCAT														
Using EtherNet/IP														
Using OPC UA														
Using FINS														
Using the database connection service														
Using the GEM Services														
Using robot control for OMRON robots														
Using robot control by NJ Robotics function														
Using numerical control														
Using the NX1P2 CPU Unit functions														
Learning about error management and corrections*1														
Maintenance														
Using motion control														
Using EtherCAT														
Using EtherNet/IP														

*1. Refer to the *NJ/NX-series Troubleshooting Manual (Cat. No. W503)* for the error management concepts and the error items. However, refer to the manuals that are indicated with triangles for details on errors corresponding to the products with the manuals that are indicated with triangles.

Manual Structure

Page Structure

The following page structure is used in this manual.

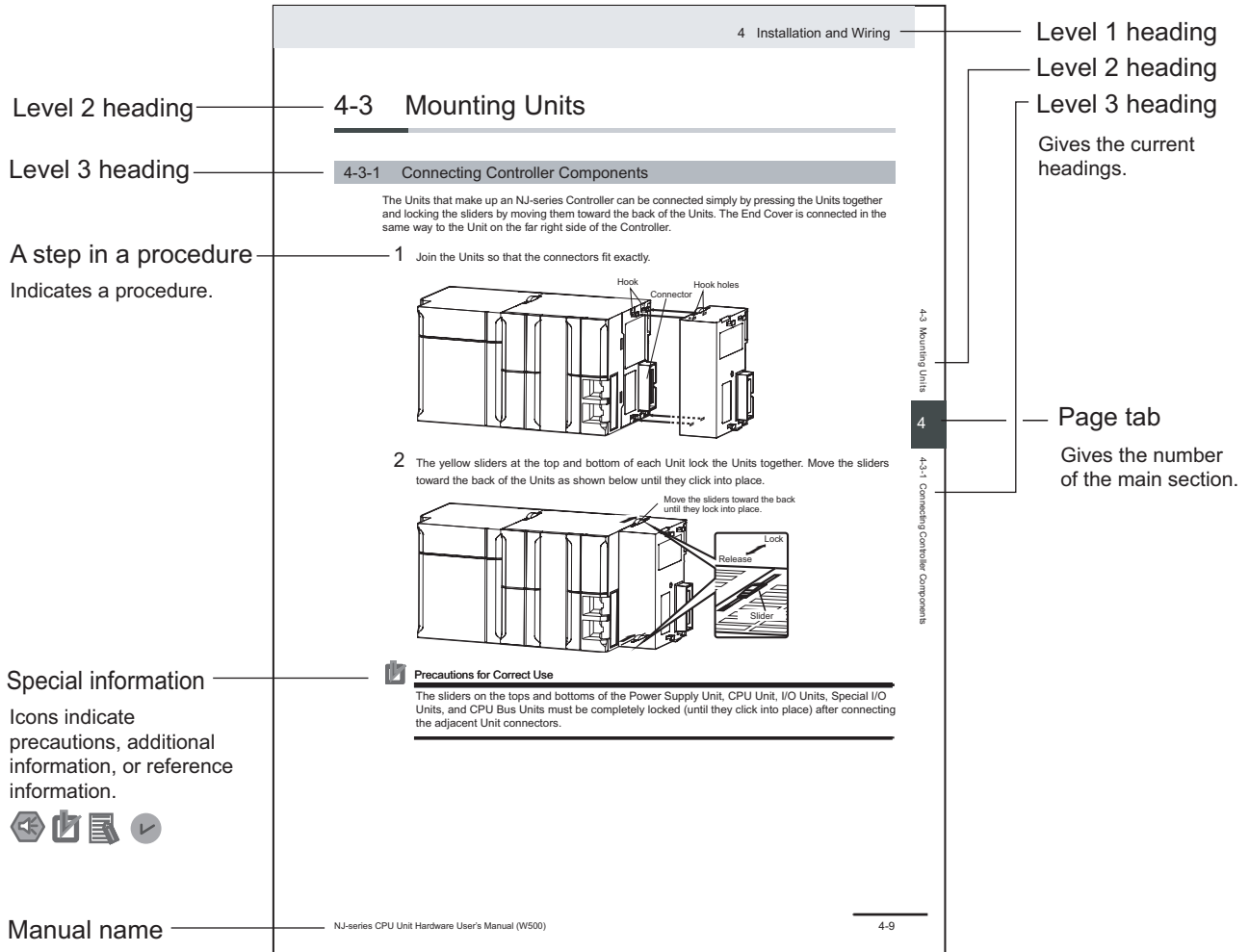

This illustration is provided only as a sample. It may not literally appear in this manual.

Special Information

Special information in this manual is classified as follows:



Precautions for Safe Use

Precautions on what to do and what not to do to ensure safe usage of the product.



Precautions for Correct Use

Precautions on what to do and what not to do to ensure proper operation and performance.



Additional Information

Additional information to read as required.

This information is provided to increase understanding or make operation easier.



Version Information

Information on differences in specifications and functionality for Controller with different unit versions and for different versions of the Sysmac Studio is given.

Precaution on Terminology

In this manual, "download" refers to transferring data from the Sysmac Studio to the physical Controller and "upload" refers to transferring data from the physical Controller to the Sysmac Studio. For the Sysmac Studio, "synchronization" is used to both "upload" and "download" data. Here, "synchronize" means to automatically compare the data for the Sysmac Studio on the computer with the data in the physical Controller and transfer the data in the direction that is specified by the user.

Sections in this Manual

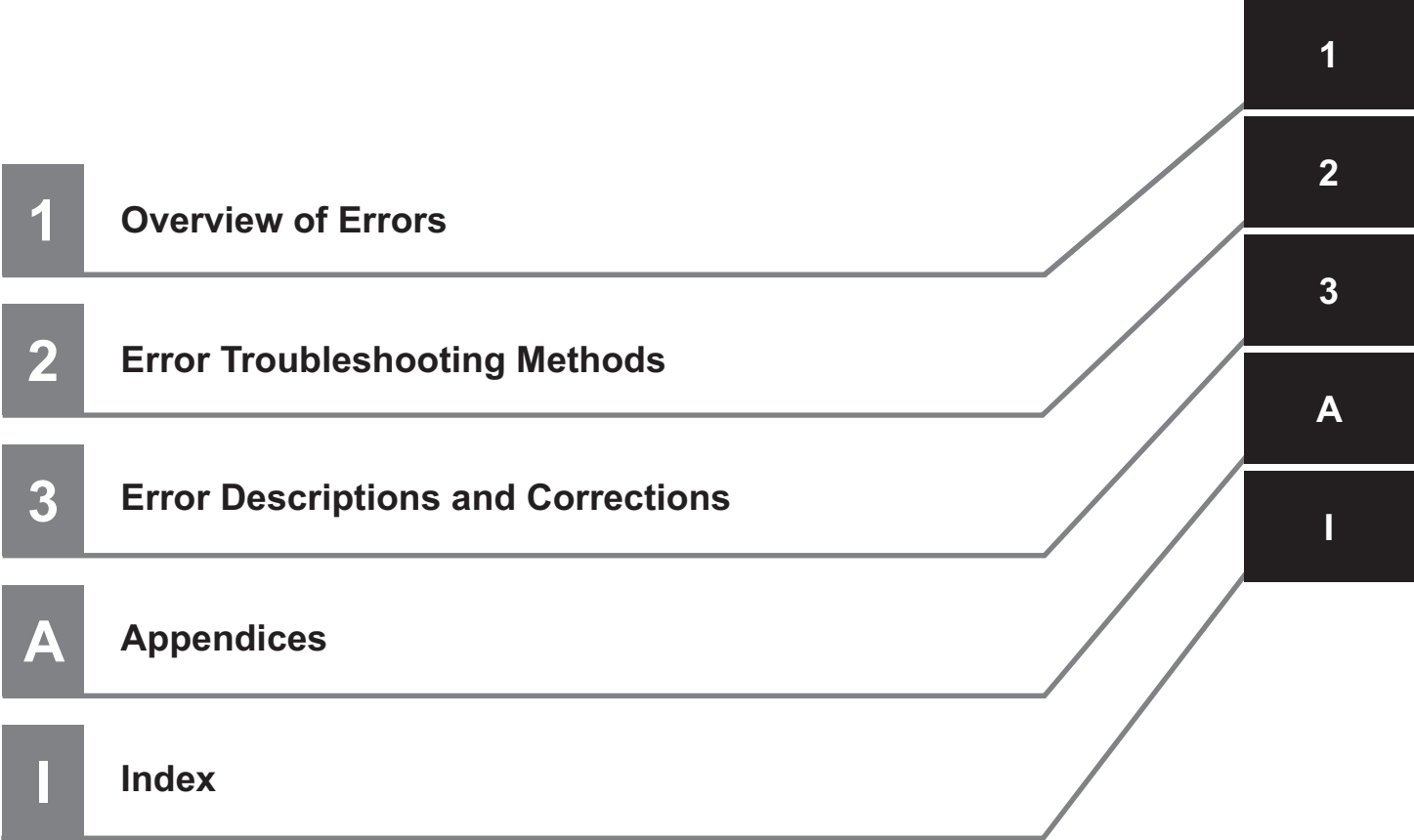

CONTENTS

Introduction	1
Intended Audience	1
Applicable Products	1
Relevant Manuals	2
Manual Structure	5
Page Structure	5
Special Information	6
Precaution on Terminology	6
Sections in this Manual	7
Terms and Conditions Agreement	11
Warranty, Limitations of Liability	11
Application Considerations	12
Disclaimers	12
Statement of security responsibilities for assumed use cases and against threats	13
Safety Precautions	14
Precautions for Safe Use	15
Precautions for Correct Use	16
Regulations and Standards	17
Versions	18
Unit Versions of CPU Units and Sysmac Studio Versions	18
Related Manuals	19
Revision History	24

Section 1 Overview of Errors

1-1 Overview of NJ/NX-series Errors	1-2
1-1-1 Types of Errors	1-4
1-1-2 CPU Unit Status	1-5
1-2 Fatal Errors	1-9
1-2-1 Types of Fatal Errors	1-9
1-2-2 Checking for Fatal Errors	1-11
1-3 Non-fatal Errors	1-12
1-3-1 Types of Non-fatal Errors	1-12
1-3-2 Checking for Non-fatal Errors	1-27
1-3-3 Resetting Non-fatal Errors	1-31
1-3-4 Errors Related to the Motion Control Function Module	1-34
1-3-5 Errors Related to the EtherNet/IP Function Module	1-38
1-3-6 Errors Related to the EtherCAT Master Function Module	1-41

Section 2 Error Troubleshooting Methods

2-1	Troubleshooting Flowcharts	2-2
2-1-1	Checking to See If the CPU Unit Is Operating	2-2
2-1-2	Troubleshooting Flowchart for Non-fatal Errors	2-4
2-1-3	Flowchart to Check Error Status on EtherNet/IP Function Module	2-5
2-2	Troubleshooting Fatal Errors	2-8
2-3	Troubleshooting Non-fatal Errors	2-10
2-3-1	Identifying and Resetting Errors with the Sysmac Studio	2-10
2-3-2	Identifying and Resetting Errors with an HMI	2-16
2-3-3	Identifying and Resetting Errors from the User Program	2-19
2-3-4	Checking for Errors with System-defined Variables	2-21
2-4	Troubleshooting When Support Software Cannot Go Online	2-24
2-4-1	Troubleshooting When You Cannot Go Online from the Sysmac Studio	2-24
2-4-2	Troubleshooting When You Cannot Go Online from the Network Configurator	2-37
2-4-3	Troubleshooting When You Cannot Go Online from the CX-Configurator FDT	2-37
2-4-4	Troubleshooting When You Cannot Go Online from the CX-Integrator.....	2-37
2-4-5	Troubleshooting When You Cannot Go Online from the CX-Protocol.....	2-37

Section 3 Error Descriptions and Corrections

3-1	Interpreting Tables	3-3
3-1-1	Interpreting Error Table	3-3
3-1-2	Interpreting Error Descriptions	3-4
3-2	Errors in the PLC Function Module	3-6
3-2-1	Error Tables	3-6
3-2-2	Error Descriptions	3-95
3-2-3	Other Troubles and Corrections	3-430
3-3	Errors in the NX Bus Function Module	3-432
3-3-1	Error Tables	3-432
3-3-2	Error Descriptions	3-436
3-4	Errors in the X Bus Function Module	3-453
3-4-1	Error Tables	3-453
3-4-2	Error Descriptions	3-455
3-5	Errors in the X Bus Unit Common Function Module	3-465
3-5-1	Error Tables	3-465
3-5-2	Error Descriptions	3-469
3-6	Errors in the Motion Control Function Module	3-487
3-6-1	Error Tables	3-487
3-6-2	Error Descriptions	3-527
3-6-3	Other Troubles and Corrections	3-672
3-7	Errors in the EtherNet/IP Function Module	3-677
3-7-1	Error Tables	3-677
3-7-2	Error Descriptions	3-686
3-7-3	Other Troubles and Corrections	3-737
3-8	Errors in the EtherCAT Master Function Module	3-738
3-8-1	Error Tables	3-738
3-8-2	Error Descriptions	3-750
3-9	Errors in the OPC UA Function	3-818
3-9-1	Error Tables	3-818
3-9-2	Error Descriptions	3-828
3-9-3	OPC UA Server-specific Troubleshooting	3-854

Appendices

A-1	Other Errors (Events) That Can Occur in the CPU Units	A-2
A-1-1	Errors in the DB Connection Service Function.....	A-2
A-1-2	Errors in GEM Services.....	A-12
A-1-3	Errors in Robot Control Function.....	A-18
A-1-4	Errors in NJ Robotics Function	A-38
A-1-5	Errors in the CNC Function	A-58
A-2	Errors (Events) That Can Occur in Connected Devices.....	A-80
A-2-1	Errors in Slave Terminals	A-80
A-2-2	Errors in EtherCAT Slaves	A-147
A-2-3	Errors in CJ-series Units	A-195
A-3	An Error Log Table for CJ-series Special Units	A-224
A-4	Events in Order of Event Codes	A-230
A-4-1	Interpreting Error Descriptions	A-230
A-4-2	Error Table.....	A-232
A-5	Applicable Range of the HMI Troubleshooter	A-300
A-5-1	Combinations of HMIs and CPU Units That Enable Using the Troubleshooter	A-300
A-5-2	System Configuration Elements Supported by the Troubleshooter	A-302
A-6	Correspondence of Events between Project Unit Version Earlier than 1.40 and Project Unit Version 1.40 or Later	A-303
A-7	Correspondence of NX Bus Events between NX102 CPU Units, NX1P2 CPU Units and Slave Terminals	A-305
A-8	Correction of Wiring for the EtherCAT Ring Topology Based on Event.....	A-306
A-8-1	Flowchart of the Procedure for the Correction of Wiring for the EtherCAT Ring Topology Based on Event.....	A-308
A-8-2	How to Correct the Wiring of Ring Topology Based on Event.....	A-310
A-9	Operation Related to the X Bus Unit.....	A-321
A-9-1	Controller Behavior for Each Level of Error	A-321
A-9-2	Operation of the Function Module When It Becomes an Event Source.....	A-321

Index

Terms and Conditions Agreement

Warranty, Limitations of Liability

Warranties

- **Exclusive Warranty**

Omron's exclusive warranty is that the Products will be free from defects in materials and workmanship for a period of twelve months from the date of sale by Omron (or such other period expressed in writing by Omron). Omron disclaims all other warranties, express or implied.

- **Limitations**

OMRON MAKES NO WARRANTY OR REPRESENTATION, EXPRESS OR IMPLIED, ABOUT NON-INFRINGEMENT, MERCHANTABILITY OR FITNESS FOR A PARTICULAR PURPOSE OF THE PRODUCTS. BUYER ACKNOWLEDGES THAT IT ALONE HAS DETERMINED THAT THE PRODUCTS WILL SUITABLY MEET THE REQUIREMENTS OF THEIR INTENDED USE.

Omron further disclaims all warranties and responsibility of any type for claims or expenses based on infringement by the Products or otherwise of any intellectual property right.

- **Buyer Remedy**

Omron's sole obligation hereunder shall be, at Omron's election, to (i) replace (in the form originally shipped with Buyer responsible for labor charges for removal or replacement thereof) the non-complying Product, (ii) repair the non-complying Product, or (iii) repay or credit Buyer an amount equal to the purchase price of the non-complying Product; provided that in no event shall Omron be responsible for warranty, repair, indemnity or any other claims or expenses regarding the Products unless Omron's analysis confirms that the Products were properly handled, stored, installed and maintained and not subject to contamination, abuse, misuse or inappropriate modification. Return of any Products by Buyer must be approved in writing by Omron before shipment. Omron Companies shall not be liable for the suitability or unsuitability or the results from the use of Products in combination with any electrical or electronic components, circuits, system assemblies or any other materials or substances or environments. Any advice, recommendations or information given orally or in writing, are not to be construed as an amendment or addition to the above warranty.

See <https://www.omron.com/global/> or contact your Omron representative for published information.

Limitation on Liability; Etc

OMRON COMPANIES SHALL NOT BE LIABLE FOR SPECIAL, INDIRECT, INCIDENTAL, OR CONSEQUENTIAL DAMAGES, LOSS OF PROFITS OR PRODUCTION OR COMMERCIAL LOSS IN ANY

WAY CONNECTED WITH THE PRODUCTS, WHETHER SUCH CLAIM IS BASED IN CONTRACT, WARRANTY, NEGLIGENCE OR STRICT LIABILITY.

Further, in no event shall liability of Omron Companies exceed the individual price of the Product on which liability is asserted.

Application Considerations

Suitability of Use

Omron Companies shall not be responsible for conformity with any standards, codes or regulations which apply to the combination of the Product in the Buyer's application or use of the Product. At Buyer's request, Omron will provide applicable third party certification documents identifying ratings and limitations of use which apply to the Product. This information by itself is not sufficient for a complete determination of the suitability of the Product in combination with the end product, machine, system, or other application or use. Buyer shall be solely responsible for determining appropriateness of the particular Product with respect to Buyer's application, product or system. Buyer shall take application responsibility in all cases.

NEVER USE THE PRODUCT FOR AN APPLICATION INVOLVING SERIOUS RISK TO LIFE OR PROPERTY OR IN LARGE QUANTITIES WITHOUT ENSURING THAT THE SYSTEM AS A WHOLE HAS BEEN DESIGNED TO ADDRESS THE RISKS, AND THAT THE OMRON PRODUCT(S) IS PROPERLY RATED AND INSTALLED FOR THE INTENDED USE WITHIN THE OVERALL EQUIPMENT OR SYSTEM.

Programmable Products

Omron Companies shall not be responsible for the user's programming of a programmable Product, or any consequence thereof.

Disclaimers

Performance Data

Data presented in Omron Company websites, catalogs and other materials is provided as a guide for the user in determining suitability and does not constitute a warranty. It may represent the result of Omron's test conditions, and the user must correlate it to actual application requirements. Actual performance is subject to the Omron's Warranty and Limitations of Liability.

Change in Specifications

Product specifications and accessories may be changed at any time based on improvements and other reasons. It is our practice to change part numbers when published ratings or features are changed, or when significant construction changes are made. However, some specifications of the Product may

be changed without any notice. When in doubt, special part numbers may be assigned to fix or establish key specifications for your application. Please consult with your Omron's representative at any time to confirm actual specifications of purchased Product.

Errors and Omissions

Information presented by Omron Companies has been checked and is believed to be accurate; however, no responsibility is assumed for clerical, typographical or proofreading errors or omissions.

Statement of security responsibilities for assumed use cases and against threats

OMRON SHALL NOT BE RESPONSIBLE AND/OR LIABLE FOR ANY LOSS, DAMAGE, OR EXPENSES DIRECTLY OR INDIRECTLY RESULTING FROM THE INFECTION OF OMRON PRODUCTS, ANY SOFTWARE INSTALLED THEREON OR ANY COMPUTER EQUIPMENT, COMPUTER PROGRAMS, NETWORKS, DATABASES OR OTHER PROPRIETARY MATERIAL CONNECTED THERETO BY DISTRIBUTED DENIAL OF SERVICE ATTACK, COMPUTER VIRUSES, OTHER TECHNOLOGICALLY HARMFUL MATERIAL AND/OR UNAUTHORIZED ACCESS.

It shall be the users sole responsibility to determine and use adequate measures and checkpoints to satisfy the users particular requirements for (i) antivirus protection, (ii) data input and output, (iii) maintaining a means for reconstruction of lost data, (iv) preventing Omron Products and/or software installed thereon from being infected with computer viruses and (v) protecting Omron Products from unauthorized access.

Safety Precautions

Refer to the following manuals for safety precautions.

- *NX-series CPU Unit Hardware User's Manual (Cat. No. W535)*
- *NX-series NX502 CPU Unit Hardware User's Manual (Cat. No. W629)*
- *NX-series NX102 CPU Unit Hardware User's Manual (Cat. No. W593)*
- *NX-series NX1P2 CPU Unit Hardware User's Manual (Cat. No. W578)*
- *NJ-series CPU Unit Hardware User's Manual (Cat No. W500)*

Precautions for Safe Use

Refer to the following manuals for precautions for safe use.

- *NX-series CPU Unit Hardware User's Manual (Cat. No. W535)*
- *NX-series NX502 CPU Unit Hardware User's Manual (Cat. No. W629)*
- *NX-series NX102 CPU Unit Hardware User's Manual (Cat. No. W593)*
- *NX-series NX1P2 CPU Unit Hardware User's Manual (Cat. No. W578)*
- *NJ-series CPU Unit Hardware User's Manual (Cat No. W500)*

Precautions for Correct Use

Refer to the following manuals for precautions for correct use.

- *NX-series CPU Unit Hardware User's Manual (Cat. No. W535)*
- *NX-series NX502 CPU Unit Hardware User's Manual (Cat. No. W629)*
- *NX-series NX102 CPU Unit Hardware User's Manual (Cat. No. W593)*
- *NX-series NX1P2 CPU Unit Hardware User's Manual (Cat. No. W578)*
- *NJ-series CPU Unit Hardware User's Manual (Cat No. W500)*

Regulations and Standards

Refer to the following manuals for regulations and standards.

- *NX-series CPU Unit Hardware User's Manual (Cat. No. W535)*
- *NX-series NX502 CPU Unit Hardware User's Manual (Cat. No. W629)*
- *NX-series NX102 CPU Unit Hardware User's Manual (Cat. No. W593)*
- *NX-series NX1P2 CPU Unit Hardware User's Manual (Cat. No. W578)*
- *NJ-series CPU Unit Hardware User's Manual (Cat No. W500)*

Versions

Hardware revisions and unit versions are used to manage the hardware and software in NJ/NX-series Units and EtherCAT slaves. The hardware revision or unit version is updated each time there is a change in hardware or software specifications. Even when two Units or EtherCAT slaves have the same model number, they will have functional or performance differences if they have different hardware revisions or unit versions.

Refer to the following manuals for versions.

- *NX-series CPU Unit Hardware User's Manual (Cat. No. W535)*
- *NX-series NX502 CPU Unit Hardware User's Manual (Cat. No. W629)*
- *NX-series NX102 CPU Unit Hardware User's Manual (Cat. No. W593)*
- *NX-series NX1P2 CPU Unit Hardware User's Manual (Cat. No. W578)*
- *NJ-series CPU Unit Hardware User's Manual (Cat No. W500)*

Unit Versions of CPU Units and Sysmac Studio Versions

The events that can occur depend on the unit versions of the NJ/NX-series CPU Unit, the EtherCAT slaves, and the NX Units. You must use the corresponding version of Sysmac Studio to display events that were added for version upgrades when troubleshooting from the Sysmac Studio or from the Troubleshooter on an HMI.

Refer to the product manuals for information on the unit versions of the CPU Unit, EtherCAT slaves, and NX Units, and for the relationship with the version of the Sysmac Studio.

Related Manuals

The followings are the manuals related to this manual. Use these manuals for reference.

Manual name	Cat. No.	Model numbers	Application	Description
NX-series CPU Unit Hardware User's Manual	W535	NX701-□□□□	Learning the basic specifications of the NX701 CPU Units, including introductory information, designing, installation, and maintenance. Mainly hardware information is provided.	An introduction to the entire NX701 system is provided along with the following information on the CPU Unit. <ul style="list-style-type: none"> • Features and system configuration • Introduction • Part names and functions • General specifications • Installation and wiring • Maintenance and inspection
NX-series NX502 CPU Unit Hardware User's Manual	W629	NX502-□□□□	Learning the basic specifications of the NX502 CPU Units, including introductory information, designing, installation, and maintenance. Mainly hardware information is provided.	An introduction to the entire NX502 system is provided along with the following information on the CPU Unit. <ul style="list-style-type: none"> • Features and system configuration • Introduction • Part names and functions • General specifications • Installation and wiring • Maintenance and inspection
NX-series NX102 CPU Unit Hardware User's Manual	W593	NX102-□□□□	Learning the basic specifications of the NX102 CPU Units, including introductory information, designing, installation, and maintenance. Mainly hardware information is provided.	An introduction to the entire NX102 system is provided along with the following information on the CPU Unit. <ul style="list-style-type: none"> • Features and system configuration • Introduction • Part names and functions • General specifications • Installation and wiring • Maintenance and inspection
NX-series NX1P2 CPU Unit Hardware User's Manual	W578	NX1P2-□□□□	Learning the basic specifications of the NX1P2 CPU Units, including introductory information, designing, installation, and maintenance. Mainly hardware information is provided.	An introduction to the entire NX1P2 system is provided along with the following information on the CPU Unit. <ul style="list-style-type: none"> • Features and system configuration • Introduction • Part names and functions • General specifications • Installation and wiring • Maintenance and inspection
NJ-series CPU Unit Hardware User's Manual	W500	NJ501-□□□□ NJ301-□□□□ NJ101-□□□□	Learning the basic specifications of the NJ-series CPU Units, including introductory information, designing, installation, and maintenance. Mainly hardware information is provided.	An introduction to the entire NJ-series system is provided along with the following information on the CPU Unit. <ul style="list-style-type: none"> • Features and system configuration • Introduction • Part names and functions • General specifications • Installation and wiring • Maintenance and inspection
NJ/NX-series CPU Unit Software User's Manual	W501	NX701-□□□□ NX502-□□□□ NX102-□□□□ NX1P2-□□□□ NJ501-□□□□ NJ301-□□□□ NJ101-□□□□	Learning how to program and set up an NJ/NX-series CPU Unit. Mainly software information is provided.	The following information is provided on a Controller built with an NJ/NX-series CPU Unit. <ul style="list-style-type: none"> • CPU Unit operation • CPU Unit features • Initial settings • Programming based on IEC 61131-3 language specifications

Manual name	Cat. No.	Model numbers	Application	Description
NX-series NX1P2 CPU Unit Built-in I/O and Option Board User's Manual	W579	NX1P2-□□□□	Learning about the details of functions only for an NX-series NX1P2 CPU Unit and an introduction of functions for an NJ/NX-series CPU Unit.	Of the functions for an NX1P2 CPU Unit, the following information is provided. <ul style="list-style-type: none"> Built-in I/O Serial Communications Option Boards Analog I/O Option Boards An introduction of following functions for an NJ/NX-series CPU Unit is also provided. <ul style="list-style-type: none"> Motion control functions EtherNet/IP communications functions EtherCAT communications functions
NJ/NX-series Instructions Reference Manual	W502	NX701-□□□□ NX502-□□□□ NX102-□□□□ NX1P2-□□□□ NJ501-□□□□ NJ301-□□□□ NJ101-□□□□	Learning detailed specifications on the basic instructions of an NJ/NX-series CPU Unit.	The instructions in the instruction set (IEC 61131-3 specifications) are described.
NJ/NX-series CPU Unit Motion Control User's Manual	W507	NX701-□□□□ NX502-□□□□ NX102-□□□□ NX1P2-□□□□ NJ501-□□□□ NJ301-□□□□ NJ101-□□□□	Learning about motion control settings and programming concepts.	The settings and operation of the CPU Unit and programming concepts for motion control are described.
NJ/NX-series Motion Control Instructions Reference Manual	W508	NX701-□□□□ NX502-□□□□ NX102-□□□□ NX1P2-□□□□ NJ501-□□□□ NJ301-□□□□ NJ101-□□□□	Learning about the specifications of the motion control instructions.	The motion control instructions are described.
NJ/NX-series CPU Unit Built-in EtherCAT® Port User's Manual	W505	NX701-□□□□ NX502-□□□□ NX102-□□□□ NX1P2-□□□□ NJ501-□□□□ NJ301-□□□□ NJ101-□□□□	Using the built-in EtherCAT port on an NJ/NX-series CPU Unit.	Information on the built-in EtherCAT port is provided. This manual provides an introduction and provides information on the configuration, features, and setup.
NJ/NX-series CPU Unit Built-in EtherNet/IP™ Port User's Manual	W506	NX701-□□□□ NX502-□□□□ NX102-□□□□ NX1P2-□□□□ NJ501-□□□□ NJ301-□□□□ NJ101-□□□□	Using the built-in EtherNet/IP port on an NJ/NX-series CPU Unit.	Information on the built-in EtherNet/IP port is provided. Information is provided on the basic setup, tag data links, and other features.
NJ/NX-series CPU Unit OPC UA User's Manual	W588	NX701-□□□□ NX502-□□□□ NX102-□□□□ NJ501-1□00	Using the OPC UA.	Describes the OPC UA.
NX-series CPU Unit FINS Function User's Manual	W596	NX701-□□20 NX502-□□□□ NX102-□□□□	Using the FINS function of an NX-series CPU Unit.	Describes the FINS function of an NX-series CPU Unit.
NJ/NX-series Database Connection CPU Units User's Manual	W527	NX701-□□20 NX502-□□□□ NX102-□□20 NJ501-□□20 NJ101-□□20	Using the database connection service with NJ/NX-series Controllers.	Describes the database connection service.
NJ-series SECS/GEM CPU Units User's Manual	W528	NJ501-1340	Using the GEM Services with NJ-series Controllers.	Provides information on the GEM Services.

Manual name	Cat. No.	Model numbers	Application	Description
NJ-series Robot Integrated CPU Unit User's Manual	O037	NJ501-R□□□	Using the NJ-series Robot Integrated CPU Unit.	Describes the settings and operation of the CPU Unit and programming concepts for OMRON ro- bot control.
Sysmac Studio Robot Integrated System Build- ing Function with Robot Inte- grated CPU Unit Operation Manual	W595	SYSMAC-SE2□□ □ SYSMAC- SE200D-64	Learning about the operating procedures and functions of the Sysmac Studio to configure Robot Inte- grated System using Robot Integrated CPU Unit.	Describes the operating procedures of the Sys- mac Studio for Robot Integrated CPU Unit.
Sysmac Studio Robot Integrated System Build- ing Function with IPC Applica- tion Controller Operation Man- ual	W621	SYSMAC-SE2□□ □ SYSMAC- SE200D-64	Learning about the operating procedures and functions of the Sysmac Studio to configure Robot Inte- grated System using IPC Application Con- troller.	Describes the operating procedures of the Sys- mac Studio for IPC Application Controller.
Sysmac Studio 3D Simulation Function Opera- tion Manual	W618	SYSMAC-SE2□□ □ SYSMAC-SA4□□ □-64	Learning about an outline of the 3D sim- ulation function of the Sysmac Studio and how to use the func- tion.	Describes an outline, execution procedures, and operating procedures for the 3D simulation func- tion of the Sysmac Studio.
NJ-series NJ Robotics CPU Unit User's Manual	W539	NJ501-4□□□ NJ501-R□□□	Controlling robots with NJ-series CPU Units.	Describes the functionality to control robots.
NJ/NY-series NC Integrated Controller User's Manual	O030	NJ501-5300 NY532-5400	Performing numerical control with NJ/NY- series Controllers.	Describes the functionality to perform the numeri- cal control.
NJ/NY-series G code Instructions Reference Manual	O031	NJ501-5300 NY532-5400	Learning about the specifications of the G code/M code in- structions.	The G code/M code instructions are described.
NJ/NX-series Troubleshooting Manual	W503	NX701-□□□□ NX502-□□□□ NX102-□□□□ NX1P2-□□□□ NJ501-□□□□ NJ301-□□□□ NJ101-□□□□	Learning about the errors that may be detected in an NJ/NX-series Con- troller.	Concepts on managing errors that may be detect- ed in an NJ/NX-series Controller and information on individual errors are described.
Sysmac Studio Version 1 Operation Manual	W504	SYSMAC -SE2□□□	Learning about the operating procedures and functions of the Sysmac Studio.	Describes the operating procedures of the Sys- mac Studio.
NX-series EtherCAT® Coupler Unit User's Manual	W519	NX-ECC□□□	Learning how to use the NX-series Ether- CAT Coupler Unit and EtherCAT Slave Terminals.	The following items are described: the overall system and configuration methods of an Ether- CAT Slave Terminal (which consists of an NX-ser- ies EtherCAT Coupler Unit and NX Units), and in- formation on hardware, setup, and functions to set up, control, and monitor NX Units through EtherCAT.
NX-series Data Reference Manual	W525	NX-□□□□□□	Referencing lists of the data that is re- quired to configure systems with NX-ser- ies Units.	Lists of the power consumptions, weights, and other NX Unit data that is required to configure systems with NX-series Units are provided.

Manual name	Cat. No.	Model numbers	Application	Description
NX-series NX Units User's Manual	W521	NX-ID□□□□ NX-IA□□□□ NX-OC□□□□ NX-OD□□□□ NX-MD□□□□	Learning how to use NX Units.	Describes the hardware, setup methods, and functions of the NX Units. Manuals are available for the following Units. Digital I/O Units, Analog I/O Units, System Units, Position Interface Units, Communications Interface Units, Load Cell Input Unit, IO-Link Master Units, and High-speed Counter Units.
	W522	NX-AD□□□□ NX-DA□□□□		
	W592	NX-HAD□□□		
	W566	NX-TS□□□□ NX-HB□□□□		
	W523	NX-PD1□□□ NX-PF0□□□ NX-PC0□□□ NX-TBX01		
	W524	NX-EC0□□□ NX-ECS□□□ NX-PG0□□□		
	W540	NX-CIF□□□		
	W565	NX-RS□□□□		
	W567	NX-ILM□□□		
	W647	NX-CT□□□□		
NX-series Safety Control Unit User's Manual	Z930	NX-SL□□□□ NX-SI□□□□ NX-SO□□□□	Learning how to use NX-series Safety Control Units.	Describes the hardware, setup methods, and functions of the NX-series Safety Control Units.
NX-series Safety Control Unit Instructions Reference Manual	Z931	NX-SL□□□□	Learning about the specifications of instructions for the Safety CPU Unit.	Describes the instructions for the Safety CPU Unit.
IO-Link System User's Manual	W570	NX-ILM□□□ GX-ILM□□□	Learning everything from an introduction to details about IO-Link Systems, including mainly software information common to all IO-Link masters, Support Software operating methods, and troubleshooting.	Provides an overview of IO-Link Systems and explains the system configuration, communications specifications, communications methods, I/O data, parameters, models, Support Software, and troubleshooting.
GX-series EtherCAT Slave Units User's Manual	W488	GX-ID□□□□ GX-OD□□□□ GX-OC□□□□ GX-MD□□□□ GX-AD□□□□ GX-DA□□□□ GX-EC□□□□ XWT-ID□□ XWT-OD□□	Learning how to use the EtherCAT remote I/O terminals.	Describes the hardware, setup methods and functions of the EtherCAT remote I/O terminals.
MX2/RX Series Inverter EtherCAT Communications Unit User's Manual	I574	3G3AX-MX2-ECT 3G3AX-RX-ECT	Learning how to connect a 3G3AX-MX2-ECT or 3G3AX-RX-ECT EtherCAT Communications Unit for MX2/RX-series Inverters.	Describes the following information for the 3G3AX-MX2-ECT and 3G3AX-RX-ECT EtherCAT Communications Unit for MX2/RX-series Inverters: installation, parameter settings required for operation, troubleshooting, and inspection methods.
AC Servomotors/Servo Drives 1S-series with Built-in EtherCAT® Communi- cations User's Manual	I586	R88M-1□ R88D-1SN□-ECT	Learning how to use the Servomotors/ Servo Drives with built-in EtherCAT Communications.	Describes the hardware, setup methods and functions of the Servomotors/Servo Drives with built-in EtherCAT Communications.
	I621	R88M-1AL□/-1AM □ R88D-1SAN□-ECT		

Manual name	Cat. No.	Model numbers	Application	Description
AC Servomotors/Servo Drives G5 Series with Built-in EtherCAT® Communications User's Manual	I576	R88M-K□ R88D-KN□-ECT	Learning how to use the AC Servomotors/ Servo Drives with built-in EtherCAT Communications.	Describes the hardware, setup methods and functions of the AC Servomotors/Servo Drives with built-in EtherCAT Communications. The Linear Motor Type models and dedicated models for position control are available in G5-series.
	I577	R88L-EC-□ R88D-KN□-ECT-L		
EtherCAT Digital-type Sensor Communication Unit Operation Manual	E413	E3X-ECT	Learning how to connect E3X-series EtherCAT Slave Units.	Provides the specifications of and describes application methods for E3X-series EtherCAT Slave Units.
E3NW-ECT EtherCAT Digital Sensor Communications Unit Operation Manual	E429	E3NW-ECT	Learning how to connect E3NW EtherCAT Slave Units.	Provides the specifications of and describes application methods for E3NW EtherCAT Slave Units.
Vision System FH/FZ5 Series User's Manual for Communications Settings	Z342	FH-□□□□ FH-□□□□-□□ FZ5-□□□□ FZ5-□□□□-□□ FZ5-□□□□ FZ5-□□□□-□□	Learning how to connect FH/FZ5-series Vision Systems	The functions, settings, and communications methods to communicate with FH/FZ5 -series Vision Systems from a PLC or other external device are described.
Displacement Sensor ZW-series Confocal Fiber Type Displacement Sensors User's Manual	Z332	ZW-CE1□	Learning how to use the ZW-series Displacement Sensors.	Describes the hardware, setup methods and functions of the ZW-series Displacement Sensors.
CJ-series Special Unit Manuals For NJ-series CPU Unit	W490	CJ1W-AD□□□□ CJ1W-DA□□□□ CJ1W-MAD42	Learning how to use CJ-series Units with an NJ-series CPU Unit.	The methods and precautions for using CJ-series Units with an NJ-series CPU Unit are described, including access methods and programming interfaces. Manuals are available for the following Units. Analog I/O Units, Insulated-type Analog I/O Units, Temperature Control Units, ID Sensor Units, High-speed Counter Units, Serial Communications Units, DeviceNet Units, EtherNet/IP Units and CompoNet Master Units.
	W491	CJ1W-TC□□□□		
	W492	CJ1W-CT021		
	W498	CJ1W-PDC15 CJ1W-PH41U CJ1W-AD04U		
	W493	CJ1W-CRM21		
	W494	CJ1W-SCU□□		
	W495	CJ1W-EIP21 CJ1W-EIP21S		
	W497	CJ1W-DRM21		
NA-series Programmable Terminal Hardware User's Manual	V117	NA5-□□W□□□□	Learning the specifications and settings required to install an NA-series Programmable Terminals and connect peripheral devices.	Information is provided on NA-series Programmable Terminal specifications, part names, installation procedures, and procedures to connect an NA Unit to peripheral devices. Information is also provided on maintenance after operation and troubleshooting.
NA-series Programmable Terminal Software User's Manual	V118	NA5-□□W□□□□ (-V□)	Learning about NA-series PT pages and object functions.	Describes the pages and object functions of the NA-series Programmable Terminals.
NS-series Programmable Terminals Programming Manual	V073	NS15-□□□□□□ NS12-□□□□□□ NS10-□□□□□□ NS8-□□□□□□ NS5-□□□□□□	Learning how to use the NS-series Programmable Terminals.	Describes the setup methods, functions, etc. of the NS-series Programmable Terminals.

*1. NX-TS□□□□ Temperature Input Units are introduced in Cat. No. W522 before Cat. No. W566 is released.

Revision History

A manual revision code appears as a suffix to the catalog number on the front and back covers of the manual.

Cat. No. W503-E1-48

↑
Revision code

Revision code	Date	Revised content
01	July 2011	<ul style="list-style-type: none"> Original production
02	March 2012	<ul style="list-style-type: none"> Added information related to the upgrade to CPU unit version 1.01, made additions and changes to events related to the addition of devices that can be connected. Corrected mistakes.
03	May 2012	<ul style="list-style-type: none"> Added information related to the upgrade to CPU unit version 1.02, made additions and changes to events related to the addition of devices that can be connected. Corrected mistakes.
04	August 2012	<ul style="list-style-type: none"> Made additions to events and changes to the contents related to the upgrade to CPU unit version 1.03. Corrected mistakes.
05	February 2013	<ul style="list-style-type: none"> Made additions to events and changes to the contents related to the upgrade to CPU unit version 1.04. Corrected mistakes.
06	April 2013	<ul style="list-style-type: none"> Made additions to events and changes to the contents related to the upgrade to CPU unit version 1.05, and corrected mistakes.
07	June 2013	<ul style="list-style-type: none"> Made additions to events and changes to the contents related to the upgrade to CPU unit version 1.06, and corrected mistakes.
08	September 2013	<ul style="list-style-type: none"> Made additions to events and changes to the contents related to the upgrade to CPU unit version 1.07, and corrected mistakes.
09	December 2013	<ul style="list-style-type: none"> Made additions to events and changes to the contents related to the upgrade to CPU unit version 1.08, and corrected mistakes.
10	July 2014	<ul style="list-style-type: none"> Corrected mistakes.
11	January 2015	<ul style="list-style-type: none"> Made additions to events and changes to the contents related to the upgrade to CPU unit version 1.10. Corrected mistakes.
12	April 2015	<ul style="list-style-type: none"> Made additions to events and changes to the contents related to the addition of the NX701-□□□□ and NJ101-□□□□. Corrected mistakes.
13	April 2016	<ul style="list-style-type: none"> Made changes to the contents related to the upgrade to CPU unit version 1.11. Corrected mistakes.
14	July 2016	<ul style="list-style-type: none"> Made changes to the contents related to the upgrade to CPU unit version 1.12. Corrected mistakes.

Revision code	Date	Revised content
15	October 2016	<ul style="list-style-type: none"> Made changes to the contents related to the upgrade to CPU unit version 1.13. Corrected mistakes.
16	April 2017	<ul style="list-style-type: none"> Made changes to the contents related to the upgrade to CPU unit version 1.14. Corrected mistakes.
17	October 2017	<ul style="list-style-type: none"> Made changes to the contents related to the upgrade to CPU unit version 1.16. Added an error log table for CJ-series Special Units. Corrected mistakes.
18	January 2018	<ul style="list-style-type: none"> Made changes to the contents related to the upgrade to CPU unit version 1.17.
19	April 2018	<ul style="list-style-type: none"> Made changes to the contents related to the addition of NX-series NX102 CPU Units. Made changes to the contents related to the upgrade to CPU unit version 1.18 and 1.30. Collected descriptions on event codes and errors of each function module of NJ/NX-series CPU Units to this manual. Moved descriptions on the followings from Section 3 to Appendices. <ul style="list-style-type: none"> a) Tables of the errors (events) that can occur in models other than the standard CPU Units b) An Error Log Table for CJ-series Special Units c) Events in Order of Event Codes Corrected mistakes.
20	July 2018	<ul style="list-style-type: none"> Added information related to the upgrade to CPU unit version 1.31, made additions and changes to events related to the addition of devices that can be connected. Corrected mistakes.
21	January 2019	<ul style="list-style-type: none"> Made changes to the contents of CPU Unit events.
22	April 2019	<ul style="list-style-type: none"> Made additions and changes to events related to the upgrade to an NX102-□□□□ CPU Unit with unit version 1.32. Made additions and changes to events related to the upgrade to an NX1P2-□□□□□□ CPU Unit, NJ501-1□00 CPU Unit, NJ301-□□□□ CPU Unit, and NJ101-□□00 CPU Unit with unit version 1.21. Corrected mistakes.
23	July 2019	<ul style="list-style-type: none"> Made additions and changes to events related to the upgrade to an NX102-□□00 CPU Unit, NX1P2-□□□□□□ CPU Unit, NJ501-1□00 CPU Unit, NJ301-□□□□ CPU Unit, and NJ101-□□00 CPU Unit with unit version 1.40. Made additions and changes to events related to the upgrade to an NX701-□□□□ CPU Unit, NJ501-4□00 CPU Unit, NJ501-4□10 CPU Unit, NJ501-1340 CPU Unit, and NJ501-5300 CPU Unit with unit version 1.21. Made additions and changes to events related to the addition of devices that can be connected. Corrected mistakes.
24	October 2019	<ul style="list-style-type: none"> Added information on the NX1P2-9B□□□□. Corrected mistakes.
25	July 2020	<ul style="list-style-type: none"> Corrected mistakes.
26	August 2020	<ul style="list-style-type: none"> Made changes to the contents related to the addition of NJ501-R□□□.
27	October 2020	<ul style="list-style-type: none"> Made changes to events related to the upgrade to CPU unit version 1.42.

Revision code	Date	Revised content
28	January 2021	<ul style="list-style-type: none"> • Made changes to the contents related to the upgrade to an NX102-□□00 and NJ501-1□00 CPU Unit with unit version 1.43. • Made changes to the contents related to the upgrade to an NX102-□□20 CPU Unit with unit version 1.36. • Made changes to the contents related to the upgrade to an NX701-1□□□ CPU Unit with unit version 1.24.
29	July 2021	<ul style="list-style-type: none"> • Added information on the functions supported by unit version 1.45 of the NX1P2-□□00, NJ301-□□00, and NJ101-□□00. • Added information on the functions supported by unit version 1.25 of the NJ501-1□20, NJ501-1340, NJ501-4□□□, NJ501-5300, and NJ101-1□20. • Added information on the functions supported by unit version 1.43 of the NJ501-R□00. • Added information of the SD Memory Card.
30	November 2021	<ul style="list-style-type: none"> • Added information related to the hardware revision D of the NJ-series CPU Unit and the hardware revision A of the NX701-□□□□.
31	April 2022	<ul style="list-style-type: none"> • Corrected mistakes.
32	April 2022	<ul style="list-style-type: none"> • Added information to Terms and Conditions Agreement.
33	June 2022	<ul style="list-style-type: none"> • Added information on the hardware revision B of NX701-□□□□.
34	October 2022	<ul style="list-style-type: none"> • Made changes accompanying the release of unit version 1.50 of the NJ-series, NX102, and NX1P2 CPU Units. • Corrected mistakes.
35	November 2022	<ul style="list-style-type: none"> • Made changes accompanying the release of unit version 1.60 of the NJ-series, NX102, and NX1P2 CPU Units. • Made changes accompanying the release of unit version 1.32 of NX701 CPU Units.
36	January 2023	<ul style="list-style-type: none"> • Corrected mistakes.
37	April 2023	<ul style="list-style-type: none"> • Added information on the NX502-1□□□.
38	July 2023	<ul style="list-style-type: none"> • Revised for the release of automation playback function.
39	October 2023	<ul style="list-style-type: none"> • Made changes accompanying the release of unit version 1.64 of the NJ-series, NX502, NX102, and NX1P2 CPU Units. • Made changes accompanying the release of unit version 1.35 of NX701 CPU Units.
40	January 2024	<ul style="list-style-type: none"> • Made changes accompanying the release of unit version 1.65 of NX502 CPU Units. • Corrected mistakes.
41	October 2024	<ul style="list-style-type: none"> • Added information related to connection of CJ1W-EIP21S to the NJ-series CPU Unit. • Corrected mistakes.
42	February 2025	<ul style="list-style-type: none"> • Corrected mistakes.
43	February 2025	<ul style="list-style-type: none"> • Corrected mistakes.
44	April 2025	<ul style="list-style-type: none"> • Made changes accompanying the release of unit version 1.68 of NX502 CPU Units. • Corrected mistakes.
45	July 2025	<ul style="list-style-type: none"> • Made changes accompanying the release of unit version 1.69 of the NJ-series, NX502, NX102, and NX1P2 CPU Units. • Made changes accompanying the release of unit version 1.36 of NX701 CPU Units. • Corrected mistakes.
46	October 2025	<ul style="list-style-type: none"> • Corrected mistakes.

Revision code	Date	Revised content
47	December 2025	<ul style="list-style-type: none">• Added information on the NX-CT□□□□.
48	April 2026	<ul style="list-style-type: none">• Added information on the functions supported by unit version 1.70 of the NJ-series, NX502, NX102, and NX1P2 CPU Units.• Added information on the functions supported by unit version 1.37 of the NX701 CPU Units.

1

Overview of Errors

This section provides information that is required to troubleshoot errors. It introduces the types of errors that can occur on an NJ/NX-series, the operation that occurs in response to errors, and the methods you can use to check for errors. Refer to *Section 2 Error Troubleshooting Methods* on page 2-1 for information on troubleshooting errors.

1-1	Overview of NJ/NX-series Errors	1-2
1-1-1	Types of Errors	1-4
1-1-2	CPU Unit Status	1-5
1-2	Fatal Errors	1-9
1-2-1	Types of Fatal Errors	1-9
1-2-2	Checking for Fatal Errors	1-11
1-3	Non-fatal Errors	1-12
1-3-1	Types of Non-fatal Errors	1-12
1-3-2	Checking for Non-fatal Errors	1-27
1-3-3	Resetting Non-fatal Errors	1-31
1-3-4	Errors Related to the Motion Control Function Module	1-34
1-3-5	Errors Related to the EtherNet/IP Function Module	1-38
1-3-6	Errors Related to the EtherCAT Master Function Module	1-41

1-1 Overview of NJ/NX-series Errors

You manage all of the errors that occur on the NJ/NX-series Controller as events. The same methods are used for all events. This allows you to see what errors have occurred and find corrections for them with the same methods for the entire range of errors that is managed (i.e., CPU Unit, NX Units, NX-series Slave Terminals, EtherCAT slaves,^{*1} and CJ-series Units).

*1. Only Sysmac devices are supported. For information on EtherCAT slaves that are Sysmac devices, refer to the *NJ/NX-series CPU Unit Built-in EtherCAT Port User's Manual (Cat. No. W505)*.

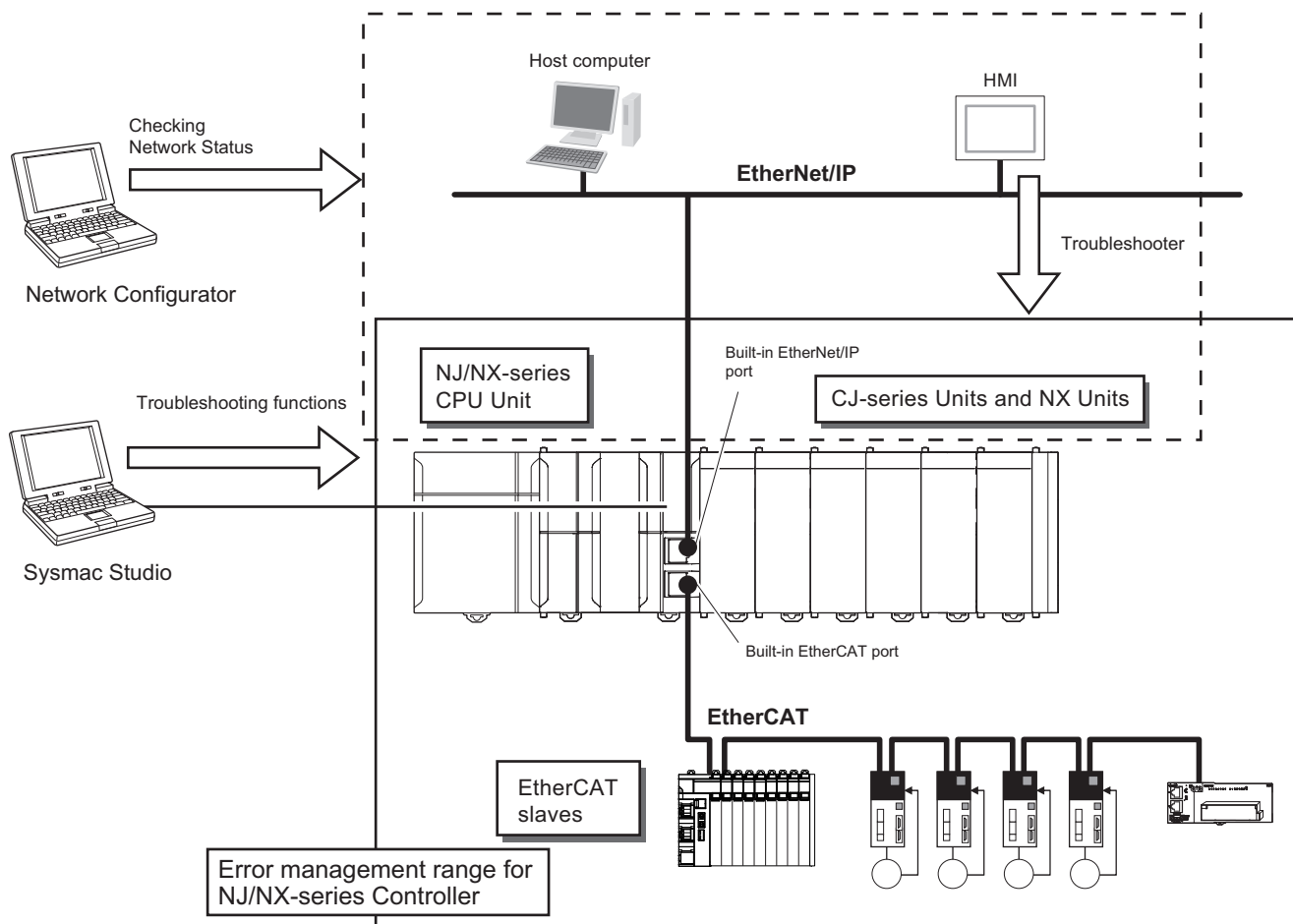

You can use the troubleshooting functions of the Sysmac Studio or the Troubleshooter on an HMI to quickly check for errors that have occurred and find corrections for them.

To perform troubleshooting from an HMI, connect the HMI to the built-in EtherNet/IP port on the CPU Unit.

You can also use the Network Configurator to check the network status of EtherNet/IP. For the procedure to check network status, refer to the methods of communications status check and troubleshooting for the EtherNet/IP network described in the *NJ/NX-series CPU Unit Built-in EtherNet/IP Port User's Manual (Cat. No. W506)*.



Precautions for Correct Use

- The only CPU Units on which CJ-series Units can be mounted are the NJ-series CPU Units.
 - The only CPU Units on which NX Units can be mounted are the NX502 CPU Units, NX102 CPU Units, and NX1P2 CPU Units.
 - Refer to the appendices of the *A-5 Applicable Range of the HMI Troubleshooter* on page A-300 for the applicable range of the HMI Troubleshooter.
-

1-1-1 Types of Errors

There are two main types of errors (events) depending on whether the NJ/NX-series can manage them or not.

● Fatal Errors

These errors are not detected by the event management function of the NJ/NX-series because the CPU Unit stops operation.

You cannot identify or reset these errors with the Sysmac Studio or an HMI.

Refer to *1-2 Fatal Errors* on page 1-9 for error types and confirmation methods of fatal errors in the CPU Unit.

● Non-fatal errors

These errors are detected and managed with the event management function of the NJ/NX-series. You can confirm these errors with the Sysmac Studio or an HMI.

Refer to *1-3 Non-fatal Errors* on page 1-12 for error types and confirmation methods of non-fatal errors in the CPU Unit.

1-1-2 CPU Unit Status

You can check the operating status of the CPU Unit with the PWR/POWER, RUN, and ERROR indicators on the front panels of the Power Supply Unit and CPU Unit.

● NX-series CPU Units

NX701 CPU Unit

Power Supply Unit

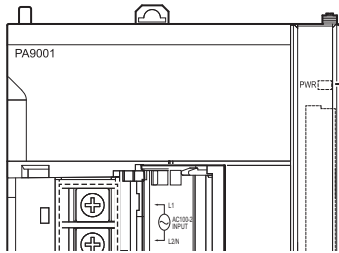

CPU Unit

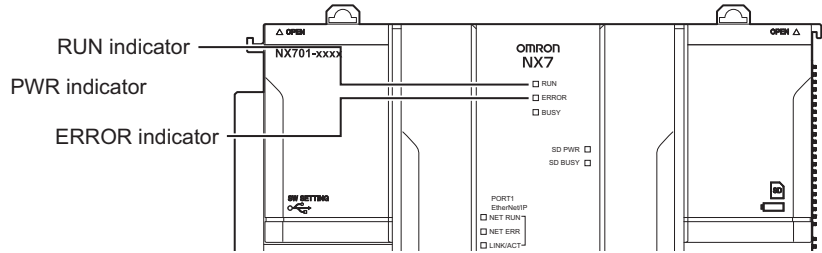

NX502 CPU Unit

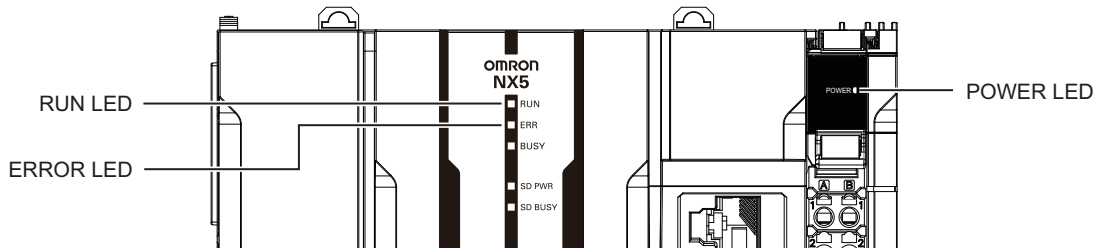

NX102 CPU Unit

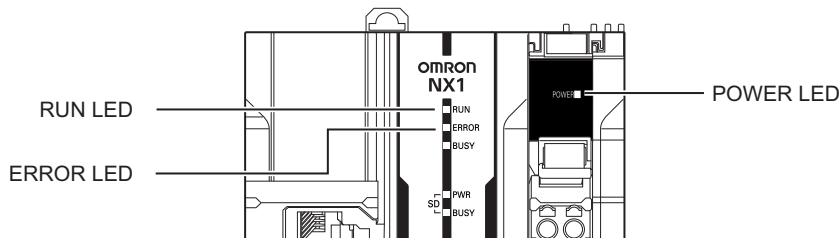

NX1P2 CPU Unit

CPU Unit

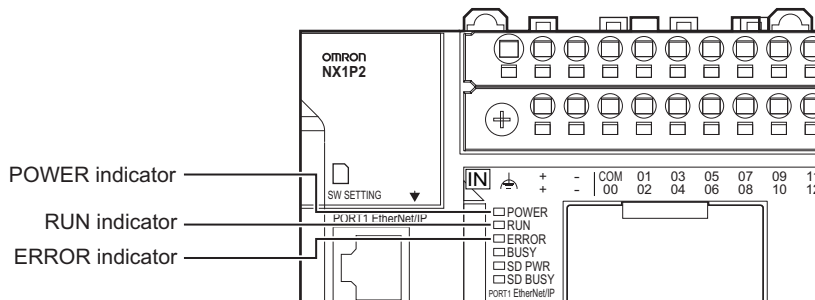

The following table shows the status of front-panel indicators, the status of user program execution, and the ability to connect communications to the Sysmac Studio or an HMI during startup, during normal operation, and when errors occur.

(○:Lit/●:Not lit/◐:Flashing)

CPU Unit operating status		Power Supply Unit/CPU Unit	CPU Units		User program execution status	Communications with Sysmac Studio or HMI
		PWR/POWER (green)	RUN (green)	ERROR (red)		
Startup		○	◐ (2-s intervals followed by 0.5-s intervals)	●	Stopped.	Not possible.
Normal operation	RUN mode	○	○	●	Continues.	Possible.
	PROGRAM mode	○	●	●	Stopped.	
Fatal error in CPU Unit	Power Supply Error*1	●	●	●	Stopped.	Not possible.
	CPU Unit Reset*1*2/ Hardware Initialization Error*1*3	○	●	●	Stopped.	
	CPU Unit Error*1	○	● or ◐ (2-s intervals or 0.5-s intervals)	○	Stopped.	
	System Initialization Error*1	○	◐ (2-s intervals) for 30 s or longer	●	Stopped.	
Non-fatal error in CPU Unit	Major Fault*4	○	●	○	Stopped.	Possible. (Communications can be connected from an HMI if EtherNet/IP is operating normally.)
	Partial fault*4	○	○	◐ (1-s intervals)	Continues.*5	
	Minor Fault*4	○	○	◐ (1-s intervals)	Continues.	
	Observation*4	○	○	●	Continues.	

- *1. Refer to 1-2 *Fatal Errors* on page 1-9 for information on individual errors.
- *2. This error can occur for NX701 CPU Units or NX502 CPU Units. If the status of indicators shown above continues 30 seconds or longer, this error exists.
- *3. This error can occur for NX102 CPU Units or NX1P2 CPU Units. If the status of indicators shown above continues 30 seconds or longer, this error exists.
- *4. Refer to 1-3 *Non-fatal Errors* on page 1-12 for information on individual errors.
- *5. The function module where the error occurred stops.



Precautions for Correct Use

When an NX502, NX102 or NX1P2 CPU Unit is used, a power shortage may occur at the CPU Rack depending on the configuration of NX Units mounted to the CPU Unit. If one of the followings occurs, use the Sysmac Studio to check if the power consumed by the Units on the CPU Rack exceeds the supplied power.

- The CPU Unit is operating but the mounted NX Units do not operate.
 - Power is supplied to the CPU Unit, but the CPU Unit does not turn ON.
-

● **NJ-series CPU Units**

Power Supply Unit

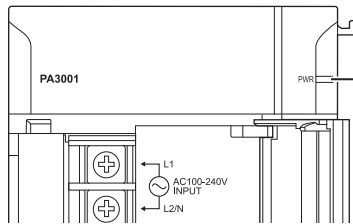

PWR indicator

CPU Unit

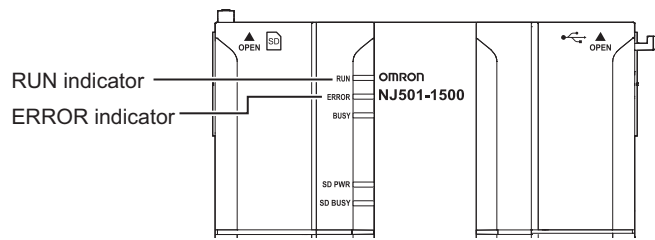

The following table shows the status of front-panel indicators, the status of user program execution, and the ability to connect communications to the Sysmac Studio or an HMI during startup, during normal operation, and when errors occur.

(○:Lit/●:Not lit/◐:Flashing)

CPU Unit operating status		Power Supply Unit	CPU Unit		User program execution status	Communications with Sysmac Studio or HMI
		PWR (green)	RUN (green)	ERROR (red)		
Startup		○	◐ (1-s intervals)	●	Stopped.	Not possible.
Normal operation	RUN mode	○	○	●	Continues.	Possible.
	PROGRAM mode	○	●	●	Stopped.	
Fatal error in CPU Unit	Power Supply Error^{*1}	●	●	●	Stopped.	Not possible.
	CPU Unit Reset^{*1}	○	●	●	Stopped.	
	Incorrect Power Supply Unit Connected^{*1}	○	◐ (3-s intervals)	○	Stopped.	
	CPU Unit Watchdog Timer Error^{*1}	○	●	○	Stopped.	
Non-fatal error in CPU Unit	Major Fault^{*2}	○	●	○	Stopped.	Possible. (Communications can be connected from an HMI if EtherNet/IP is operating normally.)
	Partial fault^{*2}	○	○	◐ (1-s intervals)	Continues. ^{*3}	
	Minor Fault^{*2}	○	○	◐ (1-s intervals)	Continues.	
	Observation^{*2}	○	○	●	Continues.	

*1. Refer to 1-2 *Fatal Errors* on page 1-9 for information on individual errors.
 *2. Refer to 1-3 *Non-fatal Errors* on page 1-12 for information on individual errors.
 *3. The function module where the error occurred stops.

1-2 Fatal Errors

1-2-1 Types of Fatal Errors

This section describes the errors that cause the CPU Unit of the NJ/NX-series to stop. The errors that can occur depend on the CPU Unit.

Communications with the Sysmac Studio or an HMI are not possible if there is a fatal error in the CPU Unit.

(○: Error that can occur)

Error name	CPU Unit			
	NX701	NX502	NX102 NX1P2	NJ-series Controller
Power Supply Error	○	○	○	○
CPU Unit Reset	○	○		○
Hardware Initialization Error			○	
Incorrect Power Supply Unit Connected				○
CPU Unit Error	○	○	○	
CPU Unit Watchdog Timer Error				○
System Initialization Error	○	○	○	

● Power Supply Error

Power is not supplied, the voltage is outside of the allowed range, or the Power Supply Unit or power supply section is faulty.

● CPU Unit Reset

The CPU Unit stopped operation because of a hardware error. For an NJ-series CPU Unit, this error can also occur for reasons other than hardware failures, as given below.

- The power supply to an Expansion Rack is OFF.
- The I/O Connecting Cable is incorrectly installed.
 - The IN and OUT connectors are reversed.
 - The connectors are not mated properly.
- There is more than one I/O Control Unit on the CPU Rack or there is an I/O Control Unit on an Expansion Rack.

● Hardware Initialization Error

This error can occur for an NX102 CPU Unit or NX1P2 CPU Unit. It indicates a data error in minimum programs required to initialize the hardware. Only the POWER indicator will be lit while the CPU Unit is starting, but if it is lit for 30 seconds or longer, then this error occurs.

● Incorrect Power Supply Unit Connected

There is a CJ-series Power Supply Unit connected to the NJ-series CPU Unit. The operation of the Controller is stopped.

● CPU Unit Watchdog Timer Error

This error can occur for an NJ-series CPU Unit. This error occurs when the watchdog timer times out because of a hardware failure or when temporary data corruption causes the CPU Unit to hang.

- **CPU Unit Error**

This error can occur for an NX-series CPU Unit. It indicates that there is a hardware failure or that the CPU is running out of control due to temporary data corruption.

- **System Initialization Error**

This error can occur for an NX-series CPU Unit. It indicates a hardware failure or data error. The RUN indicator will flash at 2-second intervals while the CPU Unit is starting, but if it flashes for 30 seconds or longer, then this error occurs.

1-2-2 Checking for Fatal Errors

You can identify fatal errors based on the status of the PWR/POWER, RUN, and ERROR indicators, as well as by the ability to connect communications to the Sysmac Studio.

Refer to *Section 2 Error Troubleshooting Methods* on page 2-1 for information on identifying errors and corrections.

● NX-series CPU Units

(○:Lit/●:Not lit/◉:Flashing)

Indicators			Communications with Sysmac Studio	CPU Unit operating status
PWR/POWER (green)	RUN (green)	ERROR (red)		
●	●	●	Not possible. *1	Power Supply Error
○	●	●		CPU Unit Reset/Hardware Initialization Error
○	● or ◉ (at 2-s intervals or 0.5-s intervals)	○		CPU Unit Error
○	◉ (2-s intervals) for 30 s or longer	●		System Initialization Error

*1. An online connection to the Sysmac Studio is necessary to differentiate between CPU Unit Resets/Hardware Initialization Errors, CPU Unit Errors, and non-fatal errors in the CPU Unit. Power Supply Errors and System Initialization Errors can be differentiated with the indicators. There is no need to see if you can go online with the CPU Unit from the Sysmac Studio.

● NJ-series CPU Unit

(○:Lit/●:Not lit/◉:Flashing)

Indicators			Communications with Sysmac Studio	CPU Unit operating status
PWR (green)	RUN (green)	ERROR (red)		
●	●	●	Not possible. *1	Power Supply Error
○	●	●		CPU Unit Reset
○	◉ (3-s intervals)	○		Incorrect Power Supply Unit Connected
○	●	○		CPU Unit Watchdog Timer Error

*1. An online connection to the Sysmac Studio is necessary to differentiate between CPU Unit Resets, CPU Unit Watchdog Timer Errors, and non-fatal errors in the CPU Unit. Power Supply Errors and Incorrect Power Supply Unit Connected errors can be differentiated with the indicators. There is no need to see if you can go online with the CPU Unit from the Sysmac Studio.

1-3 Non-fatal Errors

1-3-1 Types of Non-fatal Errors

Non-fatal errors that occur in the NJ/NX-series Controller are managed as events. You can check the event to find out what type of error occurred.

● Controller Events

The Controller automatically detects these events. Controller events include events for the function modules in the CPU Unit, NX Units, X Bus Units, NX-series Slave Terminals, EtherCAT slaves, and CJ-series Units.



Additional Information

- You cannot check the error logs that are managed independently by EtherCAT slaves on Sysmac Studio because they are not for Controller events. Refer to relevant manuals for the slaves for the procedures to read error logs and correct errors.
- Error causes and corrections are not displayed on the Controller Event Log Tab Page in the Sysmac Studio, although error codes, which are registered in the error logs that are managed independently by CJ-series Special Units, are displayed. Refer to relevant manuals for the Units for the procedures to read error logs and correct errors.

● User-defined Events

These are events that occur in applications that the user developed.

This manual does not describe user-defined events. Refer to the *NJ/NX-series CPU Unit Software User's Manual (Cat. No. W501)* for information on user-defined events.

Overview of Controller Events (Errors and Information)

You use the same methods to manage all of the events that occur on the NJ/NX-series Controller. The events that occur are saved in the CPU Unit or NX-series Slave Terminals.

You can use the Sysmac Studio or an HMI to confirm current Controller events and the log of events that occurred before. This log is called an event log.

To use an HMI to check events, connect the HMI to the built-in EtherNet/IP port on the CPU Unit.

To check events in the NX502 CPU Unit using an HMI, connect the HMI to the built-in EtherNet/IP port of the NX502 CPU Unit or to the EtherNet/IP port of an NX-series EtherNet/IP Unit connected to the NX502 CPU Unit.

The event management for NX-series Units is shown below.

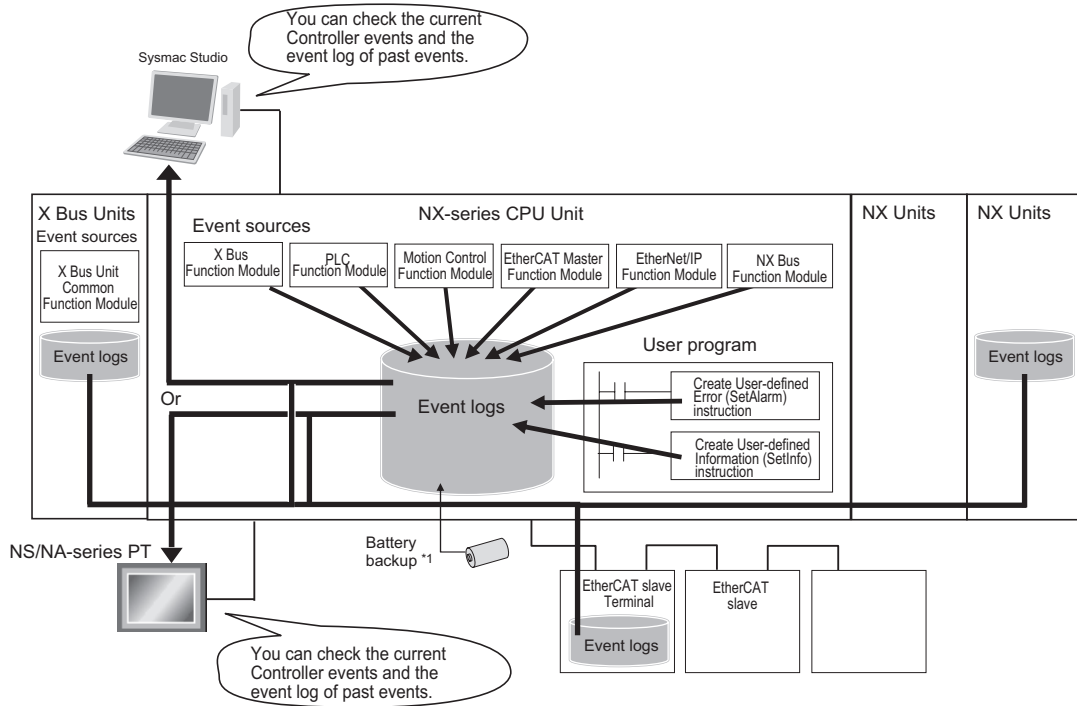

*1. The event logs are saved in battery-backup memory in the NX701 CPU Unit.
The event logs are saved in the non-volatile memory in the NX502 CPU Unit, NX102 CPU Unit and NX1P2 CPU Unit.

Precautions for Correct Use

The only CPU Units on which NX Units can be mounted are the NX502 CPU Units, NX102 CPU Units, and NX1P2 CPU Units.

The event management for NJ-series Units is shown below.

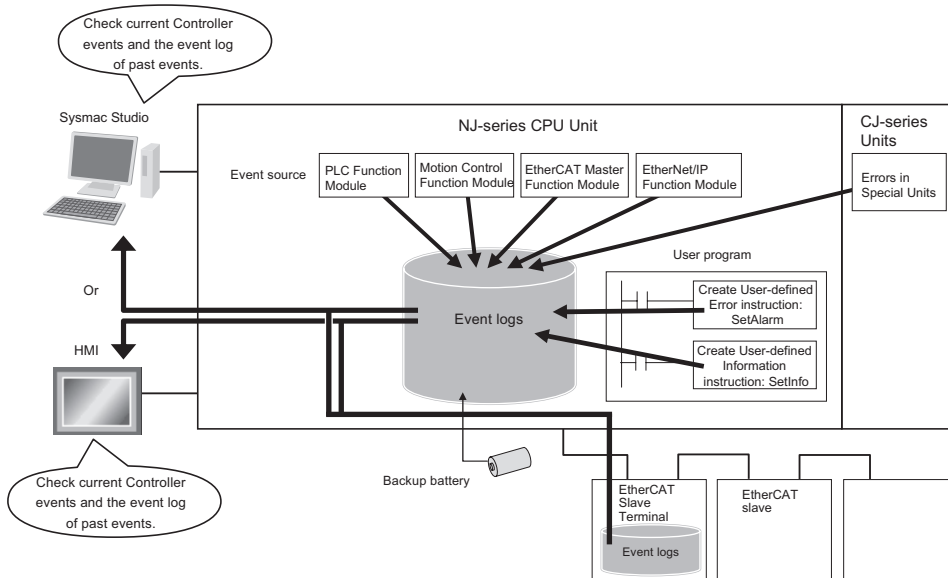



Additional Information

For an NX-series or NJ-series CPU Unit, use the following information to handle errors that occurred in an EtherCAT Slave Terminal or EtherCAT slave.

- Refer to the manual for the Communications Coupler Unit for details on the event log in a Slave Terminal.
- When there is an emergency message that notifies an error from an EtherCAT slave to the CPU Unit, it is recorded in the event log of the EtherCAT Master Function Module as the Emergency Message Detected (64200000 hex) event.
- You cannot confirm the event log for an EtherCAT slave that has no event log. To record an error history as an event, you have to change the setting of the EtherCAT slave to notify emergency messages, then the Emergency Message Detected (64200000 hex) event is recorded. However, errors which cannot be notified by emergency messages from EtherCAT slaves are not recorded in the event log.

Meanwhile, there is a way to display error history of some EtherCAT slaves that do not have the event log, on the Sysmac Studio version 1.15 or higher as the event log. Refer to relevant manuals for EtherCAT slaves for the possibility to display error history as the event log.

- Refer to relevant manuals for the slaves for the procedures to read error history of EtherCAT slaves.
-

Details on Controller Events (Errors and Information)

● Controller Event Times

The time of occurrence is recorded when an event occurs.

The times of occurrence are based on the CPU Unit's built-in clock data.

For events that occur in EtherCAT Slave Terminals, the times of occurrence are recorded based on the CPU Unit's built-in clock data that the EtherCAT Slave Terminal receives from the CPU Unit.

If the EtherCAT Slave Terminal cannot obtain the clock data from the CPU Unit, the time of occurrence on the Sysmac Studio is displayed as ----/--/-- --:--:--. For an event occurred before the EtherCAT Slave Terminal obtains the clock data from the CPU Unit, the time of occurrence is also displayed as ----/--/-- --:--:--.

The time of occurrence for an event is displayed on the Sysmac Studio or HMI.



Version Information

If the EtherCAT Slave Terminal cannot obtain the clock data from the CPU Unit or an event occurred before the EtherCAT Slave Terminal obtains the clock data from the CPU Unit, the time of occurrence is displayed as 1970/1/1 0:00:00 with Sysmac Studio version 1.14 or lower.

● Sources of Controller Events

The Event source information indicates the location where an event occurred.

The event source identifies the particular function module in the CPU Unit in which the event occurred.

For some function modules, there is more detailed information about the event source. This information is called the Source details.

The following information is provided as the event source details.

Event source	Source details
PLC Function Module	Instructions, power supply, built-in I/O, Option Board, I/O bus master, CJ-series Unit, OPC UA Server Function, DB connection service*1, or SECS/GEM*2
NX Bus Function Module *3	Master or NX Unit
X Bus Function Module *4	Master
X Bus Unit Common Function Module *4	None, X Bus Unit
Motion Control Function Module	Common, axis, or axes group
EtherCAT Master Function Module	Communications port, EtherCAT master, EtherCAT Coupler Unit, NX Unit, or EtherCAT slave
EtherNet/IP Function Module	Communications port, communications port 1, communications port 2, CIP, CIP1, CIP2, FTP, NTP, or SNMP

*1. Only for NJ/NX-series Database Connection CPU Units.

*2. Only for NJ-series SECS/GEM CPU Units.

*3. Only for NX102 CPU Units and NX1P2 CPU Units.

*4. Only for NX502 CPU Units.

Note 1. An NC Integrated Controller has the CNC Function Module. For how to check and correct errors in the CNC Function Module, refer to *NJ/NY-series NC Integrated Controller User's Manual(Cat. No. O030)*.

Note 2. The X Bus Unit has other function modules in addition to those listed above. For troubleshooting of the functional modules other than those listed above, refer to the user's manual for each X Bus Unit.

The event source is displayed on the Sysmac Studio or HMI.

● Levels of Controller Events (Errors and Information)

The following table classifies the levels of Controller events according to the effect that the errors have on control. All events in impact levels as errors are collectively called Controller errors. All other events that are not classified into errors but mean information are called Controller information.

No.	Level	Level name	Classification
1	High	Major fault level	Controller errors
2		Partial fault level	
3		Minor fault level	
4		Observation	
5	Low	Information	Controller information

Errors with a higher level have a greater impact on the functions that the NJ/NX-series Controller provides, and are more difficult to recover from.

When an event occurs, the Sysmac Studio or HMI will display the level name.

Each event level is described below.

Level	Description
Major fault level	<p>These errors prevent control operations for the entire Controller.</p> <p>When the CPU Unit detects a major fault, it immediately stops the execution of the user program and turns OFF the loads of all slave, including remote I/O.</p> <p>With EtherCAT slaves, some NX Units, and some CJ-series Special Units, you can set the slave settings or Unit settings to select whether outputs will go OFF or retain their previous status.</p> <p>You cannot reset major fault level errors from the user program, the Sysmac Studio or an HMI. To recover from a major fault level error, remove the cause of the error, and either cycle the power supply to the Controller, or reset the Controller from the Sysmac Studio.</p>
Partial fault level	<p>These errors prevent control operations in a certain function module in the Controller.</p> <p>The NJ/NX-series CPU Unit continues to execute the user program even after a partial fault level error occurs. You can include error processing in the user program in order to stop equipment safely.</p> <p>After you remove the cause of the error, execute one of the following to return to normal status.</p> <ul style="list-style-type: none"> • Reset the error from the user program, the Sysmac Studio, or an HMI. • Cycle the power supply. • Reset the Controller from the Sysmac Studio.
Minor fault level	<p>These errors prevent part of the control operations in a certain function module in the Controller.</p> <p>The troubleshooting for minor fault level errors is the same as the processing for partial fault level errors.</p>
Observations	<p>These errors do not affect the control operations of the Controller.</p> <p>The observation notifies you of potential problems before they develop into a minor fault level error or worse.</p>
Information	<p>Events that are classified as information provide information that do not indicate errors.</p>

You can change the event level for some events. Refer to *NJ/NX-series CPU Unit Software User's Manual (Cat. No. W501)* for details on changing event levels. Refer to *Section 3 Error Descriptions and Corrections* on page 3-1, *A-1 Other Errors (Events) That Can Occur in the CPU Units* on page A-2, and *A-2 Errors (Events) That Can Occur in Connected Devices* on page A-80 in this manual to see the events for which you can change the event level.

● Operation for Each Level

The way that the Controller operates when an event occurs depends on the level of the Controller event.

Item		Level of current event				
		Controller errors				Controller information
		Major fault level	Partial fault level	Minor fault level	Observation	Information
Definition		These errors are serious errors that prevent control operations for the entire Controller.	These errors prevent all of the control in a function module other than PLC Function Module.	These errors prevent part of the control operations in a certain function module.	These errors do not affect system control operations.	These are not errors, but appear in the event log to notify the user of specific information.
Example of events		<ul style="list-style-type: none"> Non-volatile Memory Data Corrupted (PLC Function) 	<ul style="list-style-type: none"> Motion Control Period Exceeded (Motion Control Function Module) Communications Controller Error (EtherCAT Master Function) 	<ul style="list-style-type: none"> Positive Limit Input Detected (Motion Control Function Module) Low Battery Voltage (PLC Function Module) 	<ul style="list-style-type: none"> Packet Discarded Due to Full Reception Buffer (EtherNet/IP Function Module) 	<ul style="list-style-type: none"> Power Turned ON Power Interrupted Memory All Cleared
Front-panel indicators *1	PWR/POWER (green)	Lit	Lit	Lit	Lit	Lit
	RUN (green)	Not lit	Lit	Lit	Lit	Lit
	ERROR (red)	Lit	Flashes at 1-s intervals.	Flashes at 1-s intervals.	Not lit	Not lit
NJ/NX-series CPU Unit operation	RUN output on Power Supply Unit	OFF	ON	ON	ON	ON
	User program execution status	Stops.	Continues.*2	Continues.	Continues.	Continues.
	Outputs turned OFF	Yes	No	No	No	No
	Error reset	Not possible.	Depends on the nature of the error.	Depends on the nature of the error.	---	---

Item		Level of current event				
		Controller errors				Controller information
		Major fault level	Partial fault level	Minor fault level	Observation	Information
	Event logs	Recorded. (Some errors are not recorded.)	Recorded.	Recorded.	Recorded.	Recorded.
	Outputs from EtherCAT slaves and Basic Output Units	Refer to <i>I/O Operation for Major Fault Level Controller Errors</i> on page 1-23	<ul style="list-style-type: none"> Errors in EtherCAT Master Function Module: Depends on settings in the slave. Errors in other function modules: According to user program. 	According to user program.	According to user program.	According to user program.
	Sysmac Studio display (when online)	Error messages are automatically displayed in the Controller Status Pane. The user can display detailed information in the Troubleshooting Dialog Box.			These items are not displayed in the error display in the Controller Status Pane.	

*1. If multiple Controller errors have occurred, the indicators show the error with the highest event level.

*2. Operation stops in the function module (NX Bus Function Module, Motion Control Function Module, EtherCAT Master Function Module, or EtherNet/IP Function Module) in which the error occurred.

● Operation in the Function Module Where an Error Event Occurred

Function module	Level of current event			
	Major fault level	Partial fault level	Minor fault level	Observation
PLC Function Module	User program execution stops.	---	Operation continues.	
NX Bus Function Module	---	I/O refreshing for NX bus communications stops. (NX Unit operation depends on the NX Unit settings.)	Operation continues. If an NX Unit error occurs, operation depends on the Fail-soft Operation Setting.	Operation continues.
X Bus Function Module	---	Data exchange between an X Bus Unit and CPU Unit stops.	<ul style="list-style-type: none"> • Data exchange with an X Bus Unit stops. • Data exchange with an X Bus Unit where an error is occurring stops. • An instruction from the user program to the X Bus function where an error is occurring ends with an error. 	---
Motion Control Function Module	---	All axes stop. (The stop method depends on the error.)	<ul style="list-style-type: none"> • The affected axis/axes group stops. (The stop method depends on the settings.) • The motion control instruction is not executed (for instructions related to axis operation.) 	<ul style="list-style-type: none"> • Axis operation continues. • The motion control instruction is not executed (for instructions not related to axis operation).

Function module	Level of current event			
	Major fault level	Partial fault level	Minor fault level	Observation
EtherCAT Master Function Module	---	EtherCAT communications stop. (The slaves operate according to the settings in the slaves.)	I/O refreshing for EtherCAT communications stops or continues according to the Fail-soft Operation Setting in the master. (If I/O refreshing stops, the slaves operate according to the settings in the slaves.)(If I/O refreshing stops, the slaves operate according to the settings in the slaves.)	I/O refreshing for EtherCAT communications continues.
EtherNet/IP Function Module	---	EtherNet/IP communications stop. (Online connections to the Sysmac Studio and communications connections with an HMI is not possible.)	Part of the EtherNet/IP communications stop. (Online connections to the Sysmac Studio and communications connections with an HMI is possible if the online connections or communications connection is not the cause of the error.)	EtherNet/IP communications continue.

Note Major fault level errors occur only in the PLC Function Module.

● I/O Operation for Major Fault Level Controller Errors

The following table gives the operation of the CPU Unit and the I/O devices.

Unit	CPU Unit operation	Unit or slave operation
NX Unit mounted to the CPU Unit *1	<ul style="list-style-type: none"> Input refreshing continues. Updating the output values is stopped. 	Depends on the settings for the NX Unit.
X Bus Unit mounted to the CPU Unit *2	Refreshing continues.	Depends on the settings for the X Bus Unit.
Built-in I/O *3	<ul style="list-style-type: none"> Depends on the Load Rejection Output Setting. Input refreshing continues. 	---
Option Boards *3	<ul style="list-style-type: none"> Outputs turned OFF. Output values depend on the specifications of the Option Board. Input refreshing stops. 	Analog I/O Option Board <ul style="list-style-type: none"> Output value: 0 V
NX-series Slave Terminal	The NX-series Slave Terminal moves to Safe-Operational state.	Depends on the NX Unit settings.
EtherCAT Slave *4	The slave is placed in the Safe-Operational state.	Depends on the slave settings. *5
Servo Drive or NX Unit assigned to an axis	Updating the command values is stopped.	All axes stop immediately.
CJ-series Basic I/O Units *6	<ul style="list-style-type: none"> The values of all outputs are cleared to zero. Input refreshing continues. 	<ul style="list-style-type: none"> All outputs are turned OFF. External inputs are refreshed.
CJ-series Special Unit *6	Refreshing continues.	Depends on the Unit operating specifications.
Devices connected with EtherNet/IP	<ul style="list-style-type: none"> For the originators of tag data links, the variables and I/O memory addresses for input (consume) tags are not refreshed. For the targets of tag data links, operation depends on the settings of the tags sets for the output (produce) tags. *7 	Depends on the specifications of the connected devices.

*1. This applies to the NX102 CPU Unit and NX1P2 CPU Unit.

*2. This applies to the NX502 CPU Unit.

*3. This applies to an NX1P2 CPU Unit.

*4. Excluding Servo Drives assigned to an axis.

*5. Settings and setting methods depend on the slave. Refer to the manual for the slave. For a Servo Drive, operation depends on the setting of object 605E hex (Fault Reaction Option Code).

*6. This applies to an NJ-series CPU Unit.

*7. You can set whether to clear output or maintain the data from before the error occurred. Refer to *NJ/NX-series CPU Unit Built-in EtherNet/IP Port User's Manual (Cat. No. W506)* for details.

The following table gives the operation of the CPU Unit and the I/O devices for the following errors that occur for an NJ-series Unit.

- Unsupported Unit Detected
- I/O Bus Check Error
- End Cover Missing
- Incorrect Unit/Expansion Rack Connection
- Duplicate Unit Number
- Too Many I/O Points

- I/O Setting Check Error

Unit	CPU Unit operation	Unit or slave operation
NX-series Slave Terminal	The NX-series Slave Terminal moves to Safe-Operational state.	Depends on the NX Unit settings.
EtherCAT Slaves ^{*1}	The slave is placed in the Safe-Operational state.	Depends on the slave settings. ^{*2}
Servo Drive or NX Unit assigned to an axis	Updating the command values is stopped.	All axes stop immediately.
CJ-series Basic I/O Unit	Refreshing is stopped.	<ul style="list-style-type: none"> All outputs are turned OFF. All inputs are turned OFF.
CJ-series Special Unit	Refreshing is stopped.	Depends on the Unit operating specifications (the ERH indicator lights).
Devices connected with Ether-Net/IP	<ul style="list-style-type: none"> For the originators of tag data links, the variables and I/O memory addresses for input (consume) tags are not refreshed. For the targets of tag data links, operation depends on the settings of the tags sets for the output (produce) tags. ^{*3} 	Depends on the specifications of the connected devices.

*1. Excluding Servo Drives assigned to an axis.

*2. Settings and setting methods depend on the slave. Refer to the manual for the slave. For a Servo Drive, operation depends on the setting of object 605E hex (Fault Reaction Option Code).

*3. You can set whether to clear output or maintain the data from before the error occurred. Refer to the *NJ/NX-series CPU Unit Built-in EtherNet/IP Port User's Manual (Cat. No. W506)* for details.

● Event Code

Events that occur in a Controller have an event code.

When an event occurs, the Sysmac Studio or HMI will display the event code.

You can use the instructions that get error status to read the error codes of current errors from the user program.

The event codes are 8-digit hexadecimal values.

The first digit of a Controller event represents its category. These categories are listed in the table below.

First digit of the code (hex)	Classification	Meaning
0	Hardware errors	An error caused by a hardware problem such as an internal part malfunction, contact failure, temperature error, undervoltage, overvoltage, or overcurrent.
1	Data errors	An error caused by incorrectly saved data or data corruption in the Controller.
2	Hardware setting errors	An error caused by incorrect handling of hardware settings (e.g., hardware switches) or restrictions (e.g., Unit assignment locations).
3	Configuration errors	An error caused by incorrect parameter values, parameters and hardware configurations that do not match, or configurations set by the user.
4	Software errors	An error caused by Controller software.
5	User software errors	An error that is caused by the user program. (For example, an input value to an instruction that is out of range.)
6	Observation errors	An error that was detected in monitoring operation that occurs due to user settings in the Controller. (For example, if the task period is exceeded or if a position outside of the motion range is detected.)
7	Control errors	An error caused by a control process. (For example, if the operating status does not meet the required conditions or if the timing is incorrect.)
8	Communications errors	An error caused by communications with an external device or host system.
9	Information	Events that are classified as information and provide information that do not indicate errors.

● Relationship between Event Codes and Error Codes

In addition to the event codes that indicate errors, the Function Modules and Units have their own error codes.

If there are corresponding event and error codes, you can tell what the other code is if you know either one of them. This allows you to know when the same error is being given when you check errors with more than one method.

The following table shows the relationship between the error codes and event codes.

Error code (4-digit hexadecimal)		Corresponding event code (8-digit hexadecimal)		Example: Event code for an error code of A123 hex
Classification	Used in	Upper 4 digits	Lower 4 digits	
Error codes for basic instructions, OPC UA instructions, DB Connection instructions, GEM instructions, CNC instructions, and robot control instructions	<i>ErrorID</i> output variable for each instruction	5401 hex	Error code	5401A123 hex
Error codes in the Motion Control Function Module	<ul style="list-style-type: none"> <i>ErrorID</i> output variable for motion control instructions System-defined variables for motion control*1 	Error code	0000 hex	A1230000 hex
Error codes for NJ Robotics function.	<ul style="list-style-type: none"> <i>ErrorID</i> output variable for basic instructions System-defined variables for motion control*1 	Error code	0000 hex	A1230000 hex
Error codes in CJ-series Special Units	Error logs from CJ-series Special Units	0000 hex	Error code	0000A123 hex

*1. The following are system-defined variables for motion control:

Variable	Name
<code>_MC_COM.PFaultLvl.Code</code>	MC Common Partial Fault Code
<code>_MC_COM.MFaultLvl.Code</code>	MC Common Minor Fault Code
<code>_MC_COM.Obsr.Code</code>	MC Common Observation Code
<code>_MC_AX[].MFaultLvl.Code</code>	Axis Minor Fault Code
<code>_MC_AX[].Obsr.Code</code>	Axis Observation Code
<code>_MC_GRP[].MFaultLvl.Code</code>	Axes Group Minor Fault Code
<code>_MC_GRP[].Obsr.Code</code>	Axes Group Observation Code

● Exporting the Event Log

You can use the Sysmac Studio or an HMI to export the displayed event log to a CSV file.

Refer to the *NJ/NX-series CPU Unit Software User's Manual (Cat. No. W501)* for information on exporting event logs.

1-3-2 Checking for Non-fatal Errors

Checking Methods

Use the following methods to check for non-fatal errors in the CPU Unit.

Checking method	What you can check
Checking the indicators	You can use the indicators to confirm the Controller error level and the error status of the EtherCAT Master Function Module and EtherNet/IP Function Module.
Checking with the troubleshooting function of the Sysmac Studio	You can check for current Controller errors, a log of past Controller errors, error sources, error causes, and corrections. You can also check error logs from CJ-series Special Units.*1
Checking with the Troubleshooter of an HMI*2	You can check for current Controller errors, a log of past Controller errors, error sources, error causes, and corrections.
Instructions that read error status	You can check the highest-level status and highest-level event code in the current Controller errors.
Checking the system-defined variables	You can check the current Controller error status for each function module.
Checking communications status with the Network Configurator	You can check the communications status (e.g., tag data link connection status) for each device on the EtherNet/IP network.
Checking with the EtherCAT diagnostic and statistical information on the Sysmac Studio	You can check the statistical information such as the number of communications frames on the EtherCAT network as well as the number of frames for which errors were detected.

*1. Detailed information, such as error causes and corrections, is not displayed.

*2. To perform troubleshooting from an HMI, connect the HMI to the built-in EtherNet/IP port on the CPU Unit. Refer to *A-5 Applicable Range of the HMI Troubleshooter* on page A-300 for the applicable range of the HMI Troubleshooter.

Checking the Indicators

● Checking the Level of a Controller Error

You can use the PWR/POWER, RUN, and ERROR indicators to determine the level of an error.

The following table shows the relationship between the Controller's indicators and the event level.

(○:Lit/●:Not lit/◐:Flashing)

Indicators			Event level
PWR/POWER (green)	RUN (green)	ERROR (red)	
○	●	○	Major fault level
○	○	◐ (1-s intervals).	Partial fault level Minor fault level
○	○	●	Observation

● Checking the Status of EtherCAT and EtherNet/IP Ports

For the EtherCAT and EtherNet/IP ports, use the EtherCAT and EtherNet/IP NET ERR indicators to determine whether an error that affects process data communications has occurred and whether a minor fault level error or higher-level error has occurred.

The indicators let you check the status given in the following table.

Indicator	Indicated status
EtherCAT NET ERR	EtherCAT Port Status <ul style="list-style-type: none"> • Lit: Errors for which normal status cannot be recovered through user actions (i.e., errors for which you must replace the CPU Unit or contact your OMRON representative). • Flashing: Errors for which normal status can be recovered through user actions. • Not lit: An error that affects process data communications has not occurred.
EtherNet/IP NET ERR	EtherNet/IP Port Status <ul style="list-style-type: none"> • Lit: Errors for which normal status cannot be recovered through user actions (i.e., errors for which you must replace the CPU Unit or contact your OMRON representative). • Flashing: Errors for which normal status can be recovered through user actions. • Not lit: There are no minor fault level or higher-level errors.

Checking with the Troubleshooting Function of Sysmac Studio

When an error occurs, you can connect the Sysmac Studio online to the Controller to check current Controller errors and the log of past Controller errors.

● Current Errors

Open the **Controller Error** Tab Page to check the current error's level, source, source details, event name, event code, username, occurrence number^{*1}, details, attached information 1 to 4, action and correction.

Observation level errors are not displayed.

*1. Displayed only for event logs generated for the NX502 CPU Unit .

● Log of Past Errors

Open the **Controller Event Log** Tab Page to check the time, level, source, source details, event name, event code, username, occurrence number, details, attached information 1 to 4, action and correction of the past errors.

Error logs from CJ-series Special Units are displayed on the **Controller Event Log** Tab Page. Detailed information is not displayed. To check detailed information, use the event codes that are displayed and refer to the error codes that are given in the manual for the relevant Unit. The relationship between error codes and event codes is described in *Details on Controller Events (Errors and Information)* on page 1-15 under *1-3-1 Types of Non-fatal Errors* on page 1-12.

Refer to the *Sysmac Studio Version 1 Operation Manual (Cat. No. W504)* for details on troubleshooting with the Sysmac Studio.

Checking with the Troubleshooter of an HMI

When an error occurs, if you can connect communications between an HMI and the Controller, you can check current Controller errors and the log of past Controller errors.

To perform troubleshooting from an HMI, connect the HMI to the built-in EtherNet/IP port on the CPU Unit.



Precautions for Correct Use

Refer to *A-5 Applicable Range of the HMI Troubleshooter* on page A-300 for the applicable range of the HMI Troubleshooter.

● Current Errors

You can check the current error's event name, event code, level, source, source details, time, details, and attached information 1 to 4.

Also, observations are not displayed as errors.

● Log of Past Errors

You can check the time, level, source, source details, event name, event code, details, attached information 1 to 4 for past errors.

Refer to the relevant HMI manual for information on the HMI Troubleshooter.

Checking with Instructions That Read Error Status

You can determine the error status with the instructions that get error status provided for each function module from the user program.

These instructions get the status and the event code of the error with the highest level.

Applicable function module	Instruction name	Instruction
PLC Function Module	Get PLC Controller Error Status	GetPLCError
	Get I/O Bus Error Status	GetCJBError
NX Bus Function Module	Get NX Bus Error Status	GetNXBError
	Get NX Unit Error Status	GetNXUnitError
X Bus Function Module, X Bus Unit Common Function Module, X Bus Ethernet Function Module, X Bus EtherNet/IP Function Module	Get X Bus Error Status	GetXBError
	Get X Bus Unit Error Status	GetXBUnitError
Motion Control Function Module	Get Motion Control Error Status	GetMCError
EtherCAT Master Function Module	Get EtherCAT Error Status	GetECError
EtherNet/IP Function Module	Get EtherNet/IP Error Status	GetEIPError

Note An NC Integrated Controller has the CNC Function Module. For how to check and correct errors in the CNC Function Module, refer to *NJ/NY-series NC Integrated Controller User's Manual*(Cat. No. 0030).

For details on the instructions that get error status, refer to the *NJ/NX-series Instructions Reference Manual* (Cat. No. W502).

Checking with System-Defined Variables

You can check the error status variables in the system-defined variables to determine the status of errors in a Controller.

You can read the Error Status variable from an external device by using communications.

You can monitor the MC Common Variable, Axis Variables, and Axes Group Variables of the system defined variables for motion control to see if errors have occurred in the Motion Control Function Module.

Refer to the *NJ/NX-series CPU Unit Software User's Manual (Cat. No. W501)* for information on system-defined variables.

Checking Communications Status with the Network Configurator

You can use the Network Configurator to check the communications status (e.g., tag data link connection status) for each device on the EtherNet/IP network. For details, refer to the methods of communications status check and troubleshooting for the EtherNet/IP network described in the *NJ/NX-series CPU Unit Built-in EtherNet/IP Port User's Manual (Cat. No. W506)*.

Checking with the EtherCAT Diagnostic and Statistical Information on the Sysmac Studio

With the Sysmac Studio, you can check the statistical information such as the number of communications frames on the EtherCAT network as well as the number of frames for which errors were detected. For details, refer to the diagnosis and statistics information for EtherCAT described in the *NJ/NX-series CPU Unit Built-in EtherCAT Port User's Manual (Cat. No. W505)*.

1-3-3 Resetting Non-fatal Errors

Unless you reset an error, the Controller will retain the error status until you turn OFF the power supply to the Controller or reset the Controller.

To reset a Controller error, it is necessary to eliminate the cause of the error. The same error will occur again if you reset the error, but do not eliminate the cause of the error.



Precautions for Safe Use

- Always confirm safety at the connected equipment before you reset Controller errors with an event level of partial fault or higher for the EtherCAT Master Function Module. When the error is reset, all slaves that were in any state other than Operational state (in which outputs are disabled) due to the Controller error with an event level of partial fault or higher will go to Operational state and the outputs will be enabled.
Before you reset all errors, confirm that no Controller errors with an event level of partial fault have occurred for the EtherCAT Master Function Module.
 - Always confirm safety at the connected equipment before you reset Controller errors for a CJ-series Special Unit. When a Controller error is reset, the Unit where the Controller error with an event level of observation or higher will be restarted.
Before you reset all errors, confirm that no Controller errors with an event level of observation or higher have occurred for the CJ-series Special Unit. Observation level events do not appear on the **Controller Error** Tab Page, so it is possible that you may restart the CJ-series Special Unit without intending to do so.
You can check the status of the `_CJB_UnitErrSta[0,0]` to `_CJB_UnitErrSta[3,9]` error status variables on a Watch Tab Page to see if an observation level Controller error has occurred.
-



Precautions for Correct Use

Resetting an error is not the same as eliminating the cause of the error.

Always eliminate the cause of an error before you perform the procedure to reset the error.

Error Resetting Methods

Method	Operation	Errors that are re-set	Description
Command from Sysmac Studio	Resetting Controller errors	Resetting all errors in the entire Controller	Reset the Controller errors from the Sysmac Studio's Troubleshooting Dialog Box.
		Resetting all Slave Terminal errors	Refer to the manual for the Communications Coupler Unit for details on resetting errors in a Slave Terminal.
		Resetting errors for individually specified NX Units	For NX Units connected to the NX bus of the CPU Unit, reset the Controller error individually from the Sysmac Studio's Troubleshooting Dialog Box. Refer to the manual for the Communications Coupler Unit for details on resetting errors individually for NX Units mounted to a Slave Terminal.
		Resetting errors for individually specified X Bus Units	For X Bus Units connected to the X Bus of the CPU Unit, reset the Controller error individually from the Sysmac Studio's Troubleshooting Dialog Box.
	Downloading	Resetting all errors for a specific function module	After the causes of the Controller errors are removed, all Controller errors in the relevant function module are reset as a result. Errors are not reset when you download the Unit Configuration and Setup.
	Clear All Memory	Resetting all errors for all function modules	After the causes of the Controller errors are removed, all Controller errors in all function modules are reset as a result. Errors for Slave Terminals are not reset.* ¹
	Controller reset		After the causes of the Controller errors are removed, all Controller errors in all function modules are reset as a result. Errors for Slave Terminals are not reset.* ¹
Clear All Memory operation for Slave Terminal	Resetting all Slave Terminal errors	If the causes for the Controller errors are removed, all Controller errors in the Slave Terminals are reset.	
	Restarting the Slave Terminal		
Commands from an HMI* ²	Resetting Controller errors	Resetting all errors in the entire Controller	Reset Controller errors from the Troubleshooter of an HMI. You can reset errors from an HMI that is not directly compatible with the NJ/NX-series Controller or another company's HMI if you use the HMI in combination with the reset error instruction for the function module in the user program.

Method	Operation	Errors that are reset	Description
Commands from the user program	Resetting Controller errors	Resetting errors for individual function modules	Execute the reset error instruction for the function module in the user program. <ul style="list-style-type: none"> For the Motion Control Function Module, you can reset all errors, errors for a particular axis, or errors for a particular axes group. For the NJ-series I/O bus, you can reset all errors or just the errors for a particular Unit. For the NX Bus Function Module, only resetting all errors is possible. For the X Bus Function Module, errors can be reset for individual Unit.
Commands from a host computer	Resetting Controller errors with CIP messages	Resetting all errors for all function modules	Use a CIP message from a host computer to reset errors.
Cycling the Controller's power supply	---	Resets all errors.	After the causes of the Controller errors are removed, all Controller errors in all function modules are reset as a result.
Cycling the power supply to the Slave Terminal	---	Resetting all Slave Terminal errors	If the causes for the Controller errors are removed, all Controller errors in the Slave Terminals are reset.

*1. Some errors are reset when the EtherCAT communications link is established rather than when the reset operation is performed.

*2. To reset errors from an HMI, connect the HMI to the built-in EtherNet/IP port on the CPU Unit.

Refer to the *Sysmac Studio Version 1 Operation Manual (Cat. No. W504)* for details on clearing errors from the Sysmac Studio.

1-3-4 Errors Related to the Motion Control Function Module

This section describes errors related to the Motion Control Function Module (sometimes abbreviated to “MC Function Module”).

Sources of Errors Related to the Motion Control Function Module

Errors can occur internally in the Motion Control Function Module, or they can occur in EtherCAT communications, which are used to connect to the Servo Drives and other slaves.

- Inside MC Function Module
- EtherCAT Master Function Module
- Built-in EtherCAT communications port hardware
- EtherCAT slaves

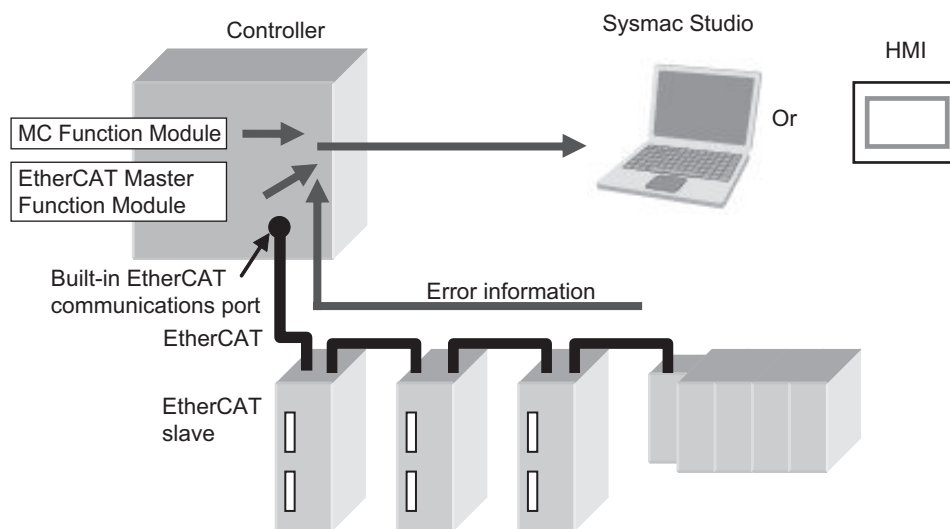

Classifications

There are the following three sources of errors in the Motion Control Function Module.

Classification	Description
MC Common Errors	If an error is detected in the common portion of the Motion Control Function Module, the corresponding bit in the MC Common Error Status variable shows the error.
Axis Error	If an error is detected for an axis, the corresponding bit in the Axis Error Status variable shows the error.*1
Axes Group Errors	If an error is detected for an axes group, the corresponding bit in the Axes Group Error Status variable shows the error.

*1. If an axis error with a minor fault level or higher level occurs, operation is also not possible for an axes group that contains the axis as a composition axis.

Note Refer to *NJ/NX-series CPU Unit Software User's Manual (Cat. No. W501)* for details on status variables.

Event Source and Level

The following tables list the errors in each event level that can occur for each source.

● MC Common Errors

Level	Error name
Major fault	None
Partial fault	<ul style="list-style-type: none"> • Motion Control Parameter Setting Error • Cam Data Read Error • Required Process Data Object Not Set • Axis Slave Disabled • Network Configuration Information Missing for Axis Slave • Motion Control Initialization Error • Motion Control Period Exceeded Error • Absolute Encoder Home Offset Read Error
Minor Fault	<ul style="list-style-type: none"> • Cam Table Save Error • Other execution errors for motion control instructions
Observation	<ul style="list-style-type: none"> • Cannot Execute Save Cam Table Instruction • Too Many Reset Motion Control Error Instructions
Information	Error Clear from MC Test Run Tab Page

● Axis Errors

Level	Error name
Major fault	None
Partial fault	None
Minor fault	<ul style="list-style-type: none"> • Cam Table Data Error during Cam Motion • Immediate Stop Instruction Executed • Positive Software Limit Exceeded • Negative Software Limit Exceeded • In-position Check Time Exceeded • Following Error Limit Exceeded • Immediate Stop Input • Positive Limit Input Detected • Negative Limit Input Detected • Illegal Following Error • Servo OFF Error • Absolute Encoder Current Position Calculation Failed • Servo Main Circuit Power OFF • Interrupt Feeding Interrupt Signal Missing • Homing Opposite Direction Limit Input Detected • Homing Direction Limit Input Detected • Homing Limit Inputs Detected in Both Directions • Home Proximity/Homing Opposite Direction Limit Input Detected • Home Proximity/Homing Direction Limit Input Detected • Home Input/Homing Opposite Direction Limit Input Detected • Home Input/Homing Direction Limit Input Detected • Invalid Home Input Mask Distance • No Home Input • No Home Proximity Input • Slave Error Detected • MC Common Error Occurrence • Latch Position Overflow • Latch Position Underflow • Master Sync Direction Error • Slave Disconnection during Servo ON • Feed Distance Overflow • Error in Changing Servo Drive Control Mode • Master Axis Position Read Error • Auxiliary Axis Position Read Error • EtherCAT Slave Communications Error • Other execution errors for motion control instructions

Level	Error name
Observation	<ul style="list-style-type: none"> • Following Error Warning • Velocity Warning • Acceleration Warning • Deceleration Warning • Positive Torque Warning • Negative Torque Warning • Command Position Overflow • Command Position Underflow • Actual Position Overflow • Actual Position Underflow • Slave Observation Detected • Notice of Insufficient Travel Distance to Achieve Blending Transit Velocity • Other execution errors for motion control instructions
Information	Slave Error Code Report

● Axes Group Errors

Level	Error name
Major fault	None
Partial fault	None
Minor fault	<ul style="list-style-type: none"> • Axes Group Immediate Stop Instruction Executed • Home Undefined during Coordinated Motion • Axes Group Composition Axis Error • Other execution errors for motion control instructions
Observation	<ul style="list-style-type: none"> • Velocity Warning • Acceleration Warning • Deceleration Warning • Notice of Insufficient Travel Distance to Achieve Blending Transit Velocity
Information	None

Errors Related to EtherCAT Communications, EtherCAT Slaves, and NX Units

The following Motion Control Function Module error can occur due to errors in EtherCAT communications, EtherCAT slaves, or NX Units.

Error name	Event code	Cause	Operation for error
EtherCAT Slave Communications Error	8440 0000 hex	A communications error occurred for the EtherCAT slave or NX Unit that is allocated to an axis in the Motion Control Function Module. *1	The Servo is turned OFF for the axis with an error and operations other than error resets are not acknowledged. *2
Slave Error Detected	742F 0000 hex	An error was detected for the EtherCAT slave or NX Unit that is allocated to an axis in the Motion Control Function Module.	The Servo is turned OFF for the axis with an error and operations other than error resets are not acknowledged.

*1. When an error occurs in communications with an EtherCAT slave, an error also occurs in the EtherCAT Master Function Module. If you assign more than one device to the same axis, a communications error occurs for the axis if a communications error occurs for even one of the devices.

*2. When an error occurs in slave communications, home becomes undefined for the axis.

Servo Drive Errors

This section describes the notification that is provided for errors that occur in OMRON 1S-series Servo Drives and G5-series Servo Drives.

There is a difference between the timing of when the Motion Control Function Module detects the error in the Servo Drive and when the error code is obtained from the Servo Drive.

The Motion Control Function Module therefore reports different events for the error in the Servo Drive and the error code.

● Error Notification

When the Motion Control Function Module detects an error, a Slave Error Detected minor fault level error (742F0000 hex) occurs.

At this point, the Motion Control Function Module performs the error operation (i.e., it turns OFF the Servo).

● Error Code Notification

When the Servo Drive reports the error code, the Motion Control Function Module generates a Slave Error Code Report information event (94220000 hex).

The error code (the main part of the error display number) from the Servo Drive is included in the lower two digits of the attached information of the Slave Error Code Report event.

For example, if the attached information is displayed as FF13, the error with display number 13 (Main Circuit Power Supply Undervoltage) occurred in the Servo Drive.



Precautions for Correct Use

You must change the settings to receive notification of the Slave Error Code Report event. Map object 603F hex (Error Code) in the PDO Edit Pane.

Errors Related to NX Units

Error and error code notifications are provided for errors that occur for OMRON NX-series Position Interface Units in the same way as they are for OMRON 1S-series Servo Drives and G5-series Servo Drives.

However, NX-series Position Interface Units do not have an object that corresponds to object 603F hex (Error Code), so 0000 hex is given for the Slave Error Code Report (94220000 hex) in the attached information.

Refer to the *NX-series Position Interface Units User's Manual (W524)* or the *NX-series EtherCAT Coupler Unit User's Manual (Cat. No. W519)* for details on errors that occur in NX-series Position Interface Units.

1-3-5 Errors Related to the EtherNet/IP Function Module

This section describes the errors that are related to the EtherNet/IP Function Module.

Classifications

There are the following sources of errors in the EtherNet/IP Master Function Module.

● NX701 CPU Units, NX502 CPU Units, and NX102 CPU Units

Classification	Description
Communications port 1 errors	If an error is detected for EtherNet/IP communications port 1, the corresponding bit in the Communications Port1 Error status variable shows the error.
Communications port 2 errors	If an error is detected for EtherNet/IP communications port 2, the corresponding bit in the Communications Port2 Error status variable shows the error.
CIP communications 1 errors	If an error that is related to the tag data links or CIP message communications is detected for EtherNet/IP communications port 1, the corresponding bit in the CIP Communications1 Error status variable shows the error.*1
CIP communications 2 errors	If an error that is related to the tag data links or CIP message communications is detected for EtherNet/IP communications port 2, the corresponding bit in the CIP Communications2 Error status variable shows the error.*1
TCP application errors	If an error that is related to the FTP server, NTP, or SMNP client is detected, the corresponding bit in the TCP Application Communications Error status variable shows the error.

*1. Other Ethernet communications are not affected.

● NX1P2 CPU Units

Classification	Description
Communications port 1 errors	If an error is detected for EtherNet/IP communications port 1, the corresponding bit in the Communications Port1 Error status variable shows the error.
CIP communications 1 errors	If an error that is related to the tag data links or CIP message communications is detected for EtherNet/IP communications port 1, the corresponding bit in the CIP Communications1 Error status variable shows the error.*1
TCP application errors	If an error that is related to the FTP server, NTP, or SMNP client is detected, the corresponding bit in the TCP Application Communications Error status variable shows the error.

*1. Other Ethernet communications are not affected.

● NJ-series CPU Units

Classification	Description
Communications port errors	If an error is detected in overall EtherCAT communications, the corresponding bit in the Communications Port Error status variable shows the error.
CIP communications errors	If an error that is related to the tag data links or CIP message communications is detected, the corresponding bit in the CIP Communications Error status variable shows the error.*1
TCP application errors	If an error that is related to the FTP server, NTP, or SMNP client is detected, the corresponding bit in the TCP Application Communications Error status variable shows the error.

*1. Other Ethernet communications are not affected.

Event Source and Level

The following table gives sources and levels of the events that can occur in the EtherNet/IP Function Module.

● NX-series CPU Units

Level	Source		
	Communications port	CIP communications	TCP application
Major fault	None	None	None
Partial fault	EtherNet/IP Processing Error	None	None
Minor fault	<ul style="list-style-type: none"> • Communications Controller Error • MAC Address Error • IP Route Table Setting Error • Basic Ethernet Setting Error • IP Address Setting Error • DNS Setting Error • DNS Server Connection Error • IP Address Duplication Error • BOOTP Server Connection Error 	<ul style="list-style-type: none"> • Identity Error • Tag Data Link Setting Error • Tag Name Resolution Error • Controller Insufficient Memory Warning • Tag Data Link Connection Failed • Tag Data Link Timeout • Tag Data Link Connection Timeout • Allowed Communications Bandwidth per Unit Exceeded 	<ul style="list-style-type: none"> • FTP Server Setting Error • NTP Client Setting Error • SNMP Setting Error • NTP Server Connection Error
Observation	<ul style="list-style-type: none"> • Access Detected Outside Range of Variable • Packet Discarded Due to Full Receive Buffer • Link OFF Detected 	None	None
Information	<ul style="list-style-type: none"> • Link Detected • Restarting Ethernet Port • IP Address Fixed • BOOTP Client Started 	<ul style="list-style-type: none"> • Tag Data Link Download Started • Tag Data Link Download Finished • Tag Data Link Stopped • Tag Data Link Started • Tag Data Link All Run 	<ul style="list-style-type: none"> • FTP Server Started • NTP Client Started • SNMP Started

● NJ-series CPU Units

Level	Source		
	Communications port	CIP communications	TCP application
Major fault	None	None	None
Partial fault	<ul style="list-style-type: none"> • Communications Controller Error • MAC Address Error • EtherNet/IP Processing Error • Basic Ethernet Setting Error • IP Address Setting Error • IP Address Duplication Error • BOOTP Server Connection Error 	None	None
Minor fault	<ul style="list-style-type: none"> • DNS Server Connection Error • IP Route Table Setting Error 	<ul style="list-style-type: none"> • Identity Error • Tag Data Link Setting Error • Tag Name Resolution Error • Controller Insufficient Memory Warning • Tag Data Link Connection Failed • Tag Data Link Timeout • Tag Data Link Connection Timeout 	<ul style="list-style-type: none"> • FTP Server Setting Error • NTP Client Setting Error • SNMP Setting Error • NTP Server Connection Error
Observation	<ul style="list-style-type: none"> • Access Detected Outside Range of Variable • Packet Discarded Due to Full Reception Buffer • Link OFF Detected 	None	None
Information	<ul style="list-style-type: none"> • Link Detected • Restarting Ethernet Port • IP Address Fixed • BOOTP Client Started 	<ul style="list-style-type: none"> • Tag Data Link Download Started • Tag Data Link Download Finished • Tag Data Link Stopped • Tag Data Link Started • Tag Data Link All Run 	<ul style="list-style-type: none"> • FTP Server Started • NTP Client Started • SNMP Started

1-3-6 Errors Related to the EtherCAT Master Function Module

This section describes the errors that are related to the EtherCAT Master Function Module.

Locations of Errors in the EtherCAT Master Function Module

Errors can occur internally in the EtherCAT Master Function Module, or they can occur in the built-in EtherCAT port or in EtherCAT slaves.

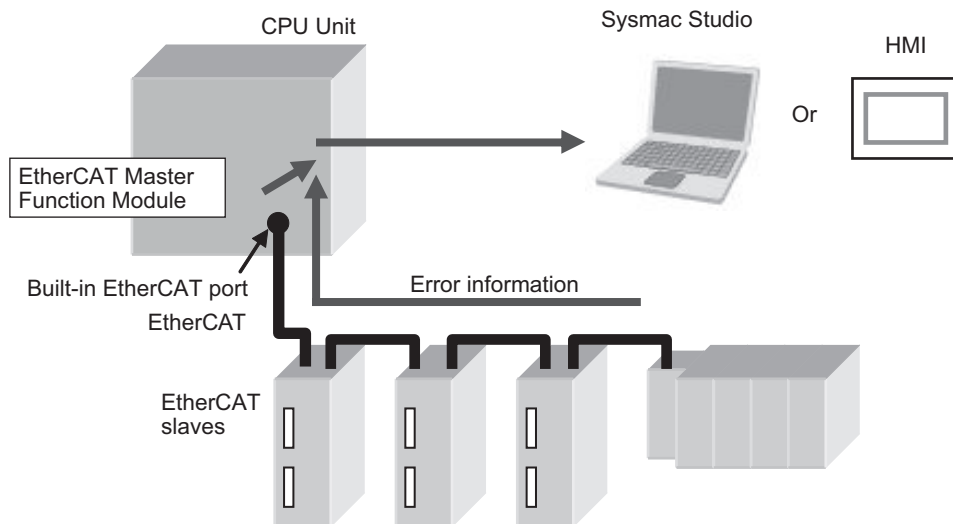

If an error occurs at the same time for more than one slave, only the error occurred for some slaves is registered among current errors or recorded in the event log as follows. When you clear a registered or recorded error on a slave, the error occurred on another slave may be registered or recorded. Make corrections repeatedly until the error is no longer registered or recorded.

● For Project Unit Version 1.40 or Later

Among the slaves in which the error occurs, the error for all slaves that can communicate is registered or recorded.

This applies to the following errors:

1. Illegal Slave Disconnection Detected
2. Network Configuration Verification Error (Slave Unconnected)
3. Network Configuration Verification Error (Mismatched Slave)

● For Project Unit Version Earlier Than 1.40

Only the error for the slave that is closest to the master among those slaves is recorded.

This applies to the following errors:

1. Network Configuration Verification Error
2. Process Data Communications Error (when caused by a disconnected cable)
3. Slave Node Address Duplicated
4. Slave Initialization Error

Classifications

There are the following sources of errors in the EtherCAT Master Function Module.

Classification	Description
Communications port errors	If an error is detected in overall EtherCAT communications, the corresponding bit in the Communications Port Error status variable shows the <i>error</i> .
EtherCAT master errors	If the EtherCAT master detects an error in its own settings or processing, the corresponding bit in the Master Error status variable shows the <i>error</i> . If the EtherCAT master detects an error in a slave, the corresponding bit in the Master Error status variable shows the <i>error</i> .
EtherCAT slave errors	If the EtherCAT master detects an error in a slave, the error status for the slave will show that the <i>master detected an error</i> . *1*2*3

- *1. The EtherCAT master periodically reads error status information from the slaves. It updates the system-defined variables at the same time as the I/O data.
- *2. The EtherCAT master will set the bits for EtherCAT slaves that do not report error status to FALSE in the Slave Error Table.
- *3. If the error in the slave is corrected after it occurs, you do not need to reset it. It is reset automatically. (This applies to CPU Unit with unit version 1.05 or later.)



Additional Information

Refer to the *NX-series EtherCAT Coupler Unit User's Manual (Cat. No. W519)* for the events that can occur for an EtherCAT Slave Terminal.

Event Source and Level

The following table gives sources and levels of the events that can occur in the EtherCAT Master Function Module. The events that can occur depend on the project unit versions^{*1}.

- *1. In this manual, the unit version set for a project is called "project unit version". A project unit version is set for a project in the Select Device Area of Project Properties Dialog Box on the Sysmac Studio.

● For Project Unit Version 1.40 or Later

Level	Source		
	Communications port	EtherCAT master	EtherCAT slaves *1
Major fault	None	None	None
Partial fault	<ul style="list-style-type: none"> Communications Controller Error Link OFF Error 	<ul style="list-style-type: none"> EtherCAT Fault EtherCAT Frame Not Received 	EtherCAT Frame Not Received

Level	Source		
	Communications port	EtherCAT master	EtherCAT slaves *1
Minor fault	None	<ul style="list-style-type: none"> • Network Configuration Information Error • Process Data Reception Timeout Error • Process Data Transmission Error • Input Process Data Invalid Error • Clock Synchronization Compensation Failed • Network Configuration Verification Error (Incorrect Wiring) • Network Configuration Verification Error (Incorrect Ring Wiring) • Incorrect Wiring Detected • Wait for Cycling Power Supply 	<ul style="list-style-type: none"> • Slave Node Address Duplicated • Network Configuration Verification Error (Incorrect Wiring) • Network Configuration Verification Error (Slave Unconnected) • Network Configuration Verification Error (Mismatched Slave) • Slave State Transition Failed • Slave AL Status Error Detected • Illegal Slave Disconnection Detected • Slave PDI WDT Error Detected
Observation	None	<ul style="list-style-type: none"> • EtherCAT Slave Backup Failed • EtherCAT Slave Restore Operation Failed • Ring Disconnection Detected 	<ul style="list-style-type: none"> • Emergency Message Detected • Illegal Mailbox Received
Information	None	<ul style="list-style-type: none"> • Errors Reset • EtherCAT Diagnosis/Statistics Log Started • EtherCAT Diagnosis/Statistics Log Ended 	<ul style="list-style-type: none"> • Slave Disconnected • Slave Connected • Slave Disabled • Slave Enabled

*1. Slave errors that are detected by the master are listed. There will also be a master error if any of these errors occurs. For slave errors that are not detected by the master, the errors and levels are defined by the individual slaves. Refer to the manual for the slave.

Refer to the *NX-series EtherCAT Coupler Unit User's Manual (Cat. No. W519)* for the events that can occur for an EtherCAT Slave Terminal.

● For Project Unit Version Earlier Than 1.40

Level	Source		
	Communications port	EtherCAT master	EtherCAT slaves *1
Major fault	None	None	None
Partial fault	<ul style="list-style-type: none"> • Communications Controller Error • MAC Address Error • Link OFF Error 	<ul style="list-style-type: none"> • EtherCAT Processing Error • EtherCAT Frame Not Received 	EtherCAT Frame Not Received

Level	Source		
	Communications port	EtherCAT master	EtherCAT slaves *1
Minor fault	None	<ul style="list-style-type: none"> Slave Node Address Duplicated Network Configuration Information Error EtherCAT Communications Cycle Exceeded Network Configuration Error Network Configuration Verification Error Slave Initialization Error Process Data Transmission Error Process Data Reception Timeout Error Input Process Data Invalid Error 	<ul style="list-style-type: none"> Network Configuration Verification Error Slave Application Error Process Data Communications Error Slave Node Address Duplicated Slave Initialization Error
Observation	None	<ul style="list-style-type: none"> EtherCAT Slave Backup Failed EtherCAT Slave Restore Operation Failed EtherCAT Message Error 	Emergency Message Detected
Information	None	<ul style="list-style-type: none"> Error Reset EtherCAT Diagnosis/Statistics Log Started EtherCAT Diagnosis/Statistics Log Ended 	<ul style="list-style-type: none"> Slave Disconnected Slave Connected Slave Disabled Slave Enabled

*1. Slave errors that are detected by the master are listed. There will also be a master error if any of these errors occurs. For slave errors that are not detected by the master, the errors and levels are defined by the individual slaves. Refer to the manual for the slave.

Refer to the *NJ-series EtherCAT Coupler Unit User's Manual* (Cat. No. W519) for the events that can occur for an EtherCAT Slave Terminal.

Error Reset of EtherCAT Master Function Module

There are three methods to reset errors of the EtherCAT Master Function Module.

- Sysmac Studio
- HMI
- Execution of the Reset EtherCAT Error (ResetECError) instruction

Refer to 2-3 *Troubleshooting Non-fatal Errors* on page 2-10 for the resetting procedures from the Sysmac Studio or an HMI.

Refer to the *NJ/NX-series Instructions Reference Manual* (Cat. No. W502) for details on the Reset EtherCAT Error (ResetECError) instruction.



Precautions for Correct Use

The current errors in the EtherCAT Master Function Module cannot be reset during the occurrence of a Wait for Cycling Power Supply event (94520000 hex) (page 3-750).

● Resetting Errors in the EtherCAT Master Function Module

Before you reset the following errors, always make sure that the slave with the error is participating in the network.

- Resetting a Network Configuration Verification Error or Process Data Communications Error while the power supply to the slave is ON or while the cable is connected
- Resetting a Link OFF Error while the power supply is ON to the first slave where the cable was disconnected or while the cable is connected

Use the following procedure.

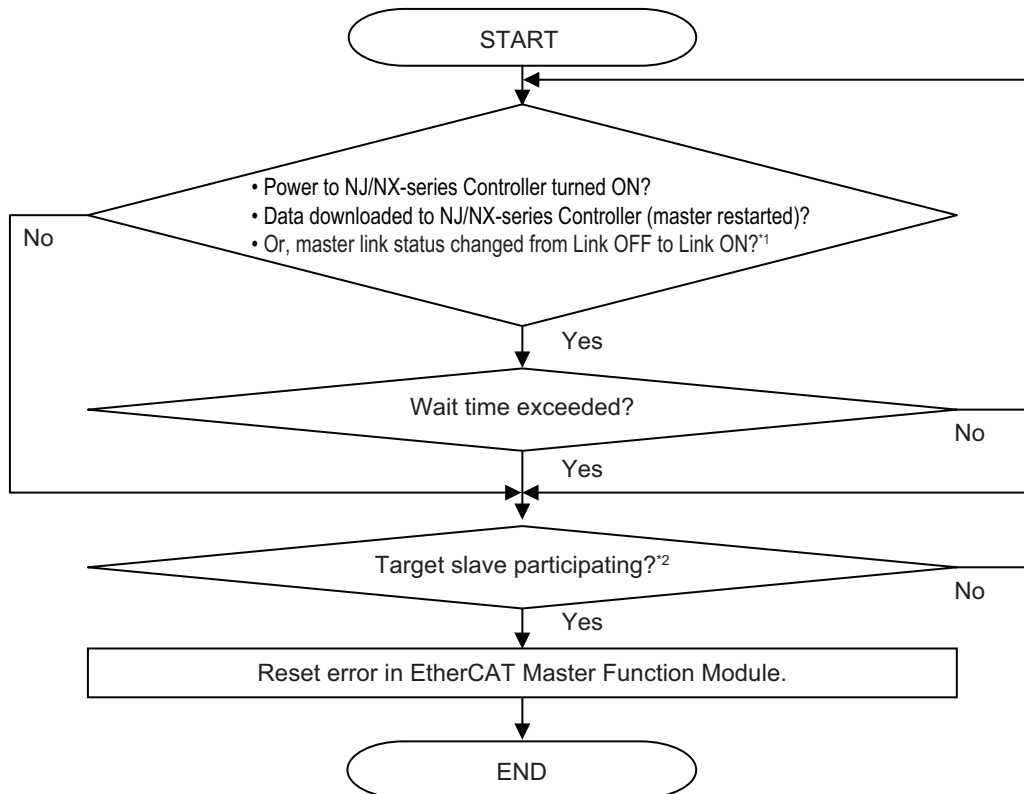

*1. Check the `_EC_LinkStatus` (Link Status) system-defined variable.

*2. Check the `_EC_EntrySlavTbl[]` (Network Connected Slave Table) system-defined variable.

Also, set the wait time for slave startup in the EtherCAT master settings (EtherCAT master parameter settings) long enough to allow for the power supply startup time of all of the slaves.

If you reset the error in the EtherCAT Master Function Module without using the above procedure, the EtherCAT master may access a slave with a different node address than the specified node address, or other unexpected operations may occur. Also, the error may not be reset correctly.

● Resetting Slave Errors

You can reset errors in the EtherCAT Master Function Module to reset slave errors. However, process data communications between the EtherCAT master and EtherCAT slave must be active to reset a slave error.

If process data communications with the slave are not active, check the slave after you reset errors in the EtherCAT Master Function Module to see if process data communications are active. Then, to reset the error in the slave, reset errors in the EtherCAT Master Function Module again.

Precautions When Connecting or Disconnecting Slaves during Communications

This section describes the procedure and precautions for replacing a slave that is currently performing communications.

● Procedure for Disconnecting Slaves during Communications

Always use the following procedure to turn OFF the slave power supply or disconnect cables during EtherCAT master communications.*

* This includes the safe-operational and operational states.

Step 1: Use the Sysmac Studio or an instruction to send a command to disconnect the slave.

Step 2: Confirm that the slave was disconnected normally.

Step 3: Turn OFF the power supply to the slave or disconnect the cable.

If you turn OFF the power supply or disconnect the cable without performing steps 1 and 2, the slaves that are operating may be adversely affected.

● Prohibition to Physically Disconnecting a Slave and Resetting an Error or Connecting a Slave at the Same Time

If you perform the following operation (a) or (b) at the same time as operation (c), an error will occur.

a. Turn OFF the power supply to the slave or disconnect the cable.

b. Turn ON the power supply to the slave or connect the cable.

c. Reset an error in the EtherCAT Master Function Module or connect the slave.*

* This can happen when the Reset EtherCAT Error (ResetECError) instruction or Connect EtherCAT Slave (EC_ConnectSlave) instruction is cyclically executed in the user program.

If you perform these operations at the same time, the EtherCAT master may access a slave with a different node address than the specified node address, or other unexpected operations may occur. Therefore, never turn OFF the power supply to the slave or disconnect the cable at the same time as you reset an error or connect a slave.

2

Error Troubleshooting Methods

This section describes troubleshooting methods for specific errors.

2-1	Troubleshooting Flowcharts	2-2
2-1-1	Checking to See If the CPU Unit Is Operating	2-2
2-1-2	Troubleshooting Flowchart for Non-fatal Errors.....	2-4
2-1-3	Flowchart to Check Error Status on EtherNet/IP Function Module	2-5
2-2	Troubleshooting Fatal Errors	2-8
2-3	Troubleshooting Non-fatal Errors	2-10
2-3-1	Identifying and Resetting Errors with the Sysmac Studio.....	2-10
2-3-2	Identifying and Resetting Errors with an HMI	2-16
2-3-3	Identifying and Resetting Errors from the User Program	2-19
2-3-4	Checking for Errors with System-defined Variables	2-21
2-4	Troubleshooting When Support Software Cannot Go Online.....	2-24
2-4-1	Troubleshooting When You Cannot Go Online from the Sysmac Studio	2-24
2-4-2	Troubleshooting When You Cannot Go Online from the Network Configurator	2-37
2-4-3	Troubleshooting When You Cannot Go Online from the CX-Configurator FDT	2-37
2-4-4	Troubleshooting When You Cannot Go Online from the CX-Integrator.....	2-37
2-4-5	Troubleshooting When You Cannot Go Online from the CX-Protocol.....	2-37

2-1 Troubleshooting Flowcharts

This section provides basic error identification and troubleshooting flowcharts. Use them when an error occurs in the NJ/NX-series Controller.

2-1-1 Checking to See If the CPU Unit Is Operating

When an error occurs in the NJ/NX-series Controller, use the following flowchart to determine whether the error is a fatal error or a non-fatal error.

Whenever possible, set the Sysmac Studio's software connection method in the flowchart to a direct USB connection if the CPU Unit has a USB (peripheral) port. If you use Ethernet, there are many reasons that prevent a communications connection for the Sysmac Studio, so time is required to determine if a fatal or non-fatal error has occurred.

If you cannot go online from the Sysmac Studio, perform *2-4-1 Troubleshooting When You Cannot Go Online from the Sysmac Studio* on page 2-24 before you assume that the error is a fatal error.

● NX-series CPU Units

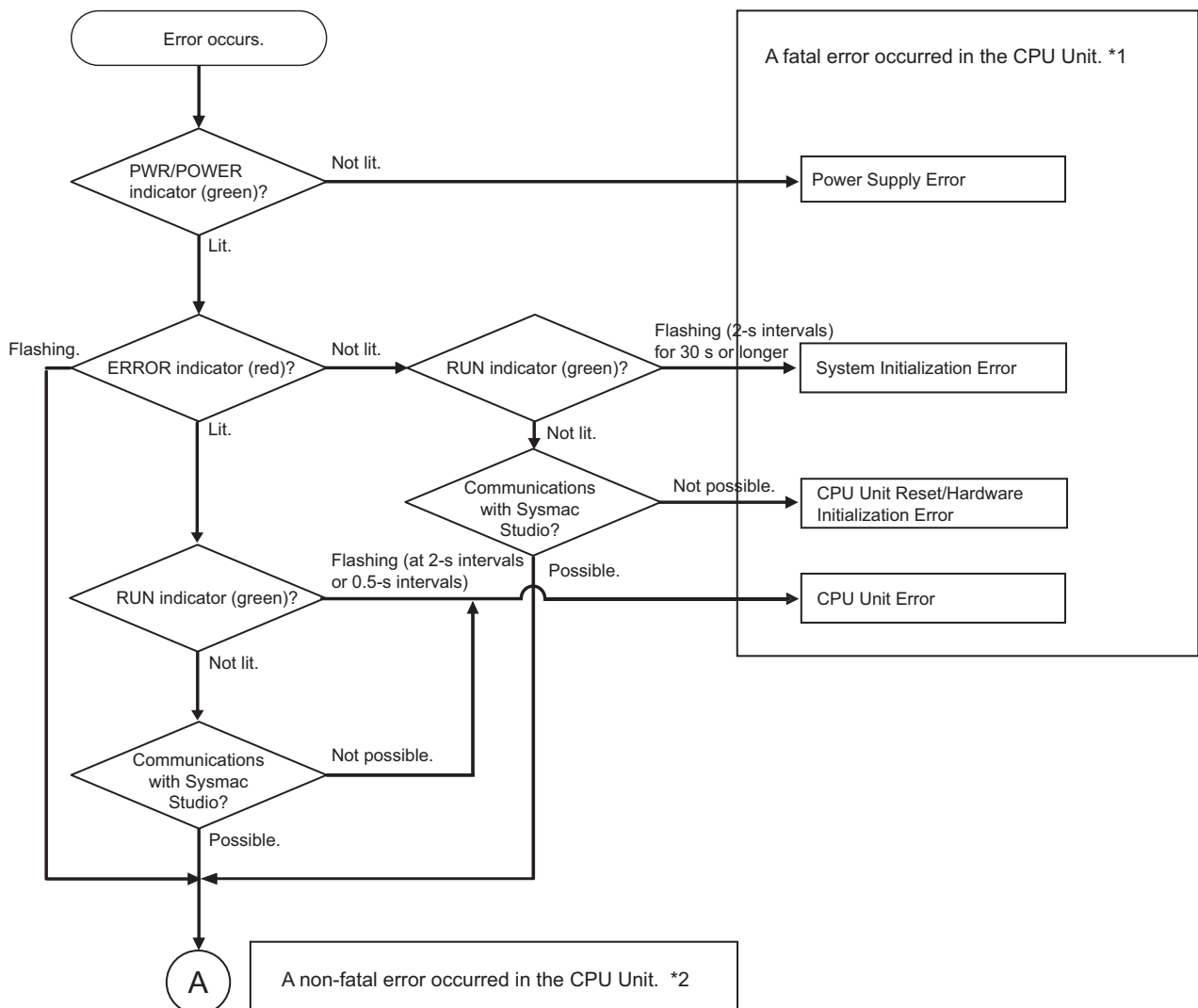

*1. Refer to *2-2 Troubleshooting Fatal Errors* on page 2-8.

*2. Refer to 2-1-2 Troubleshooting Flowchart for Non-fatal Errors on page 2-4.

● NJ-series CPU Units

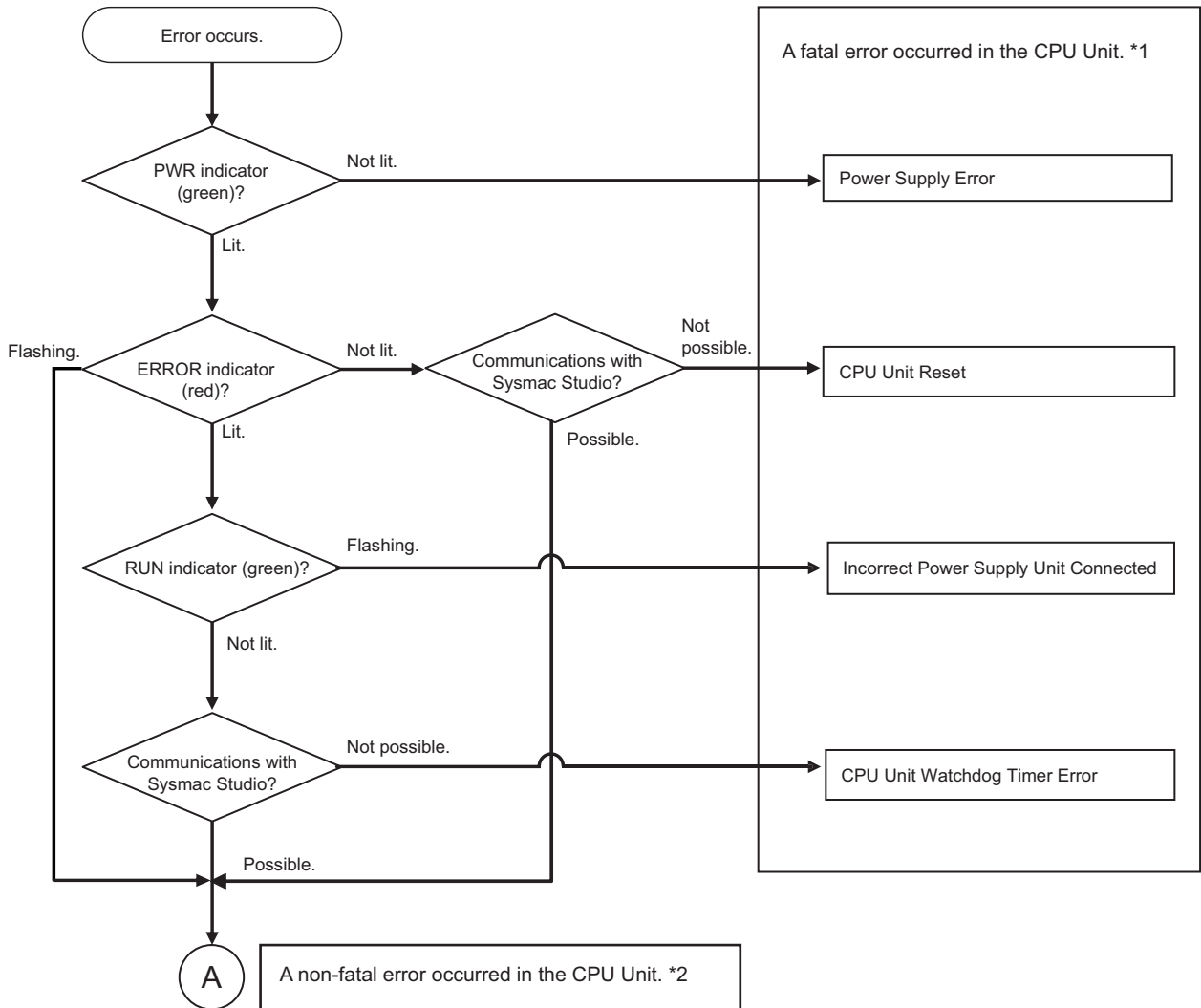

*1. Refer to 2-2 Troubleshooting Fatal Errors on page 2-8.

*2. Refer to 2-1-2 Troubleshooting Flowchart for Non-fatal Errors on page 2-4.

2-1-2 Troubleshooting Flowchart for Non-fatal Errors

For a non-fatal error, use the Sysmac Studio or an HMI to troubleshoot the error with the following flowchart.

You can use the indicators to check the following:

- Level
- Whether the error is in the EtherNet/IP port or the EtherCAT port
- If the source of the error is the EtherNet/IP port or the EtherCAT port, whether you can restore normal status yourself

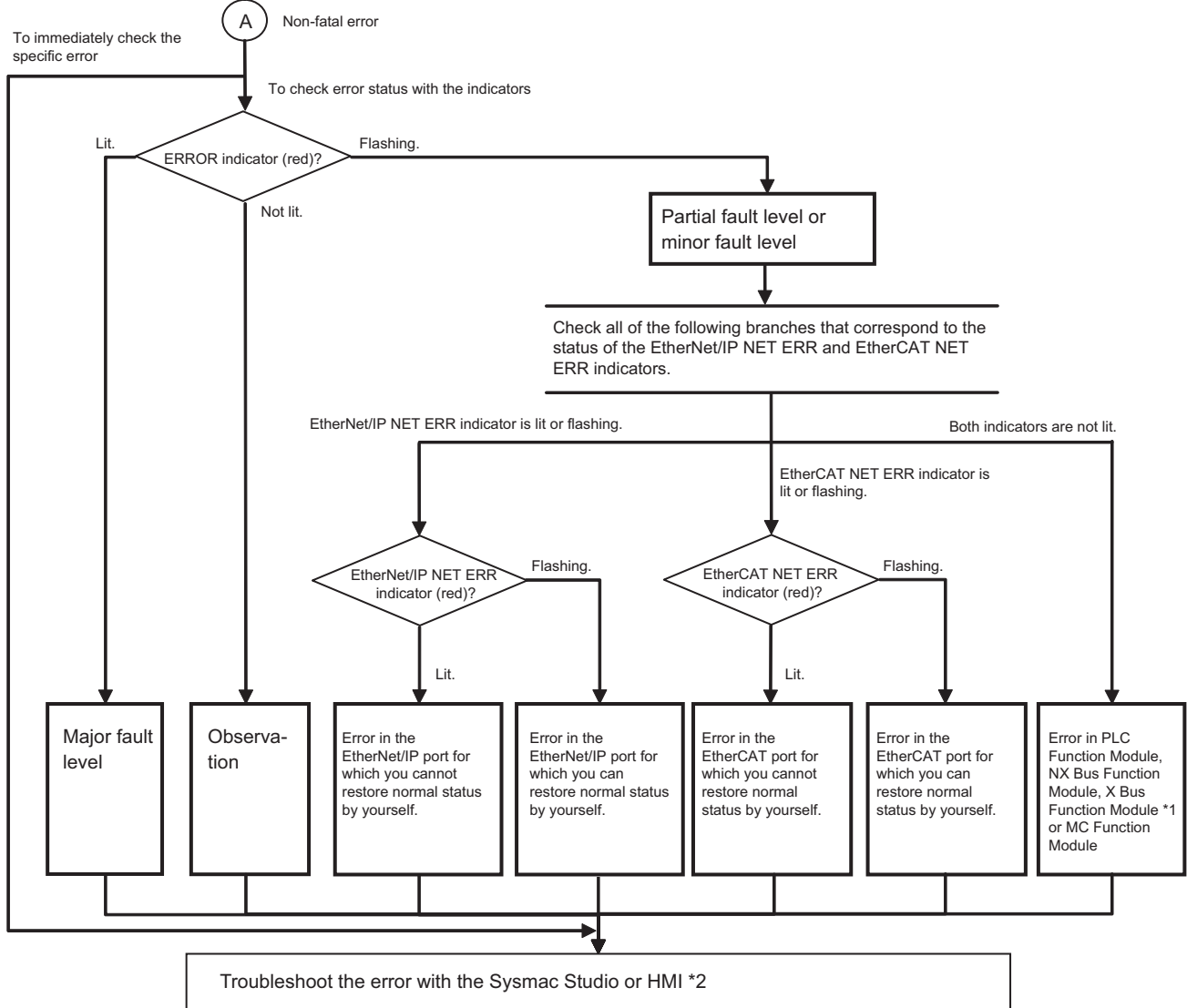

*1. Refer to the 3-4 *Errors in the X Bus Function Module* on page 3-453 for information on X Bus errors. For information on the X Bus Unit errors, refer to *Troubleshooting* in the user's manual for each X Bus Unit.
 *2. Refer to 2-3 *Troubleshooting Non-fatal Errors* on page 2-10.



Precautions for Correct Use

Refer to A-5 *Applicable Range of the HMI Troubleshooter* on page A-300 for the applicable range of the HMI Troubleshooter.

2-1-3 Flowchart to Check Error Status on EtherNet/IP Function Module

When an error occurs in the EtherNet/IP Function Module, use the following flowchart to check the error and take necessary measures.

NX701 CPU Unit and NX102 CPU Unit

To differentiate between the two communications ports in the flowchart, the port for which to isolate the error is called the relevant port.

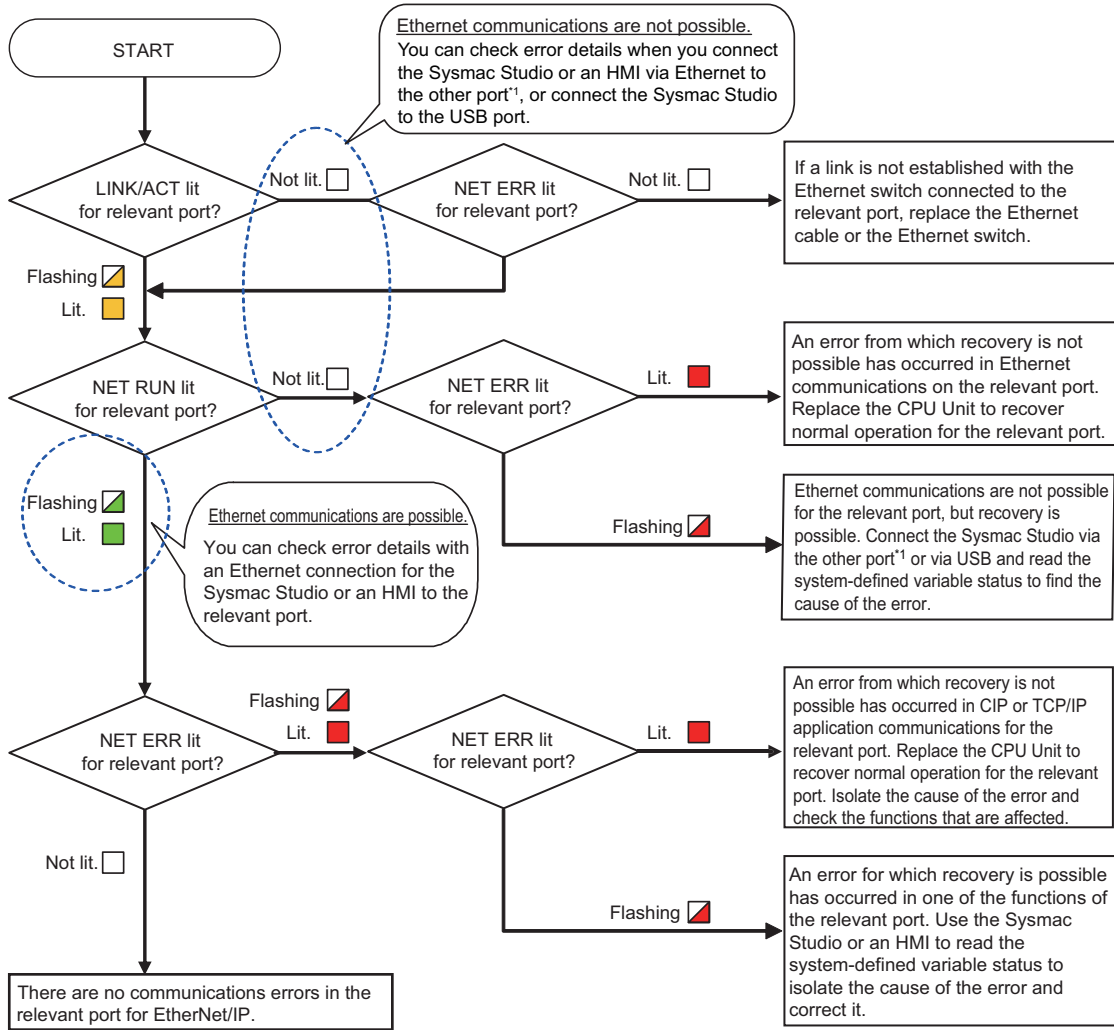

*1. You can connect the Sysmac Studio or an HMI to the other port to confirm error details only when Ethernet communications are possible for the other port.

NX502 CPU Unit and NX1P2 CPU Unit

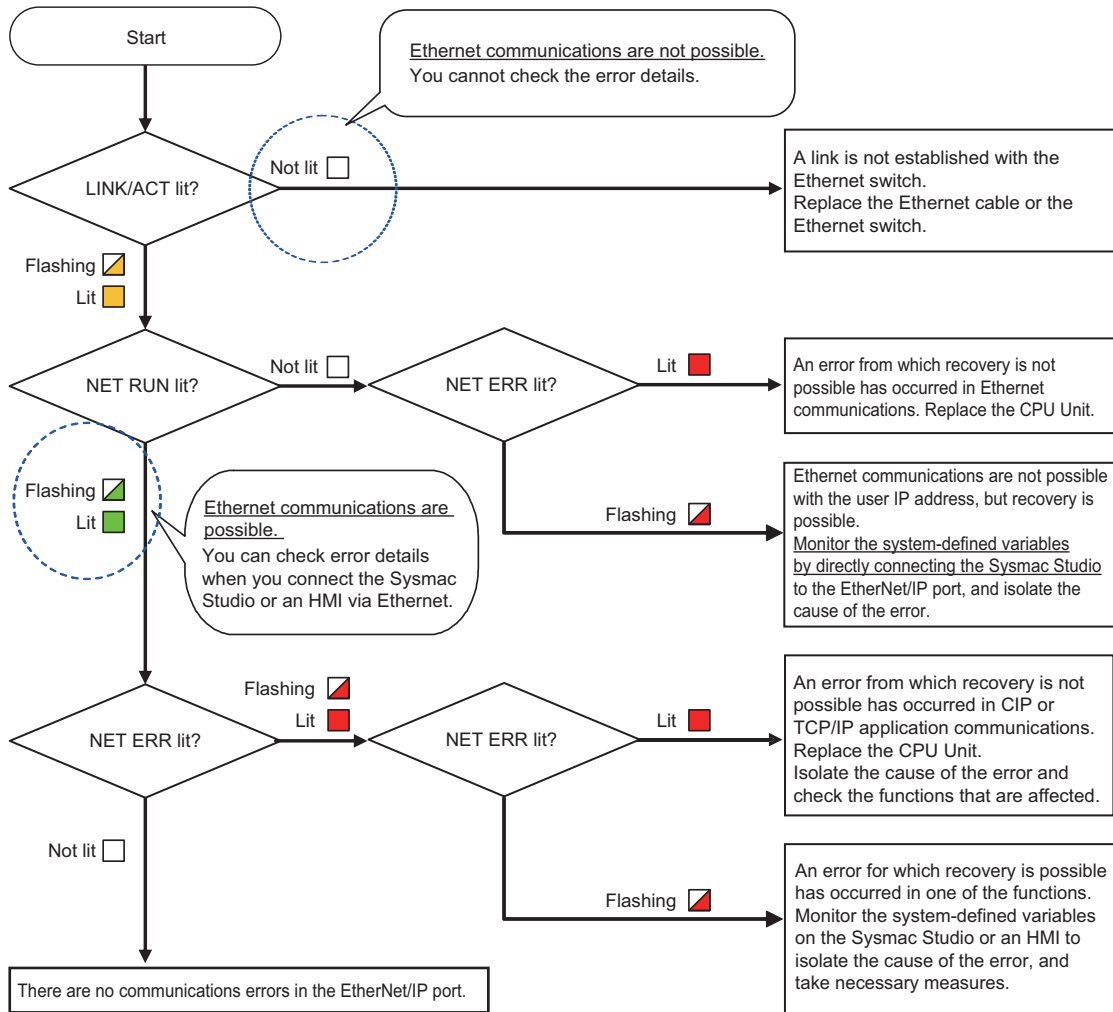

NJ-series CPU Units

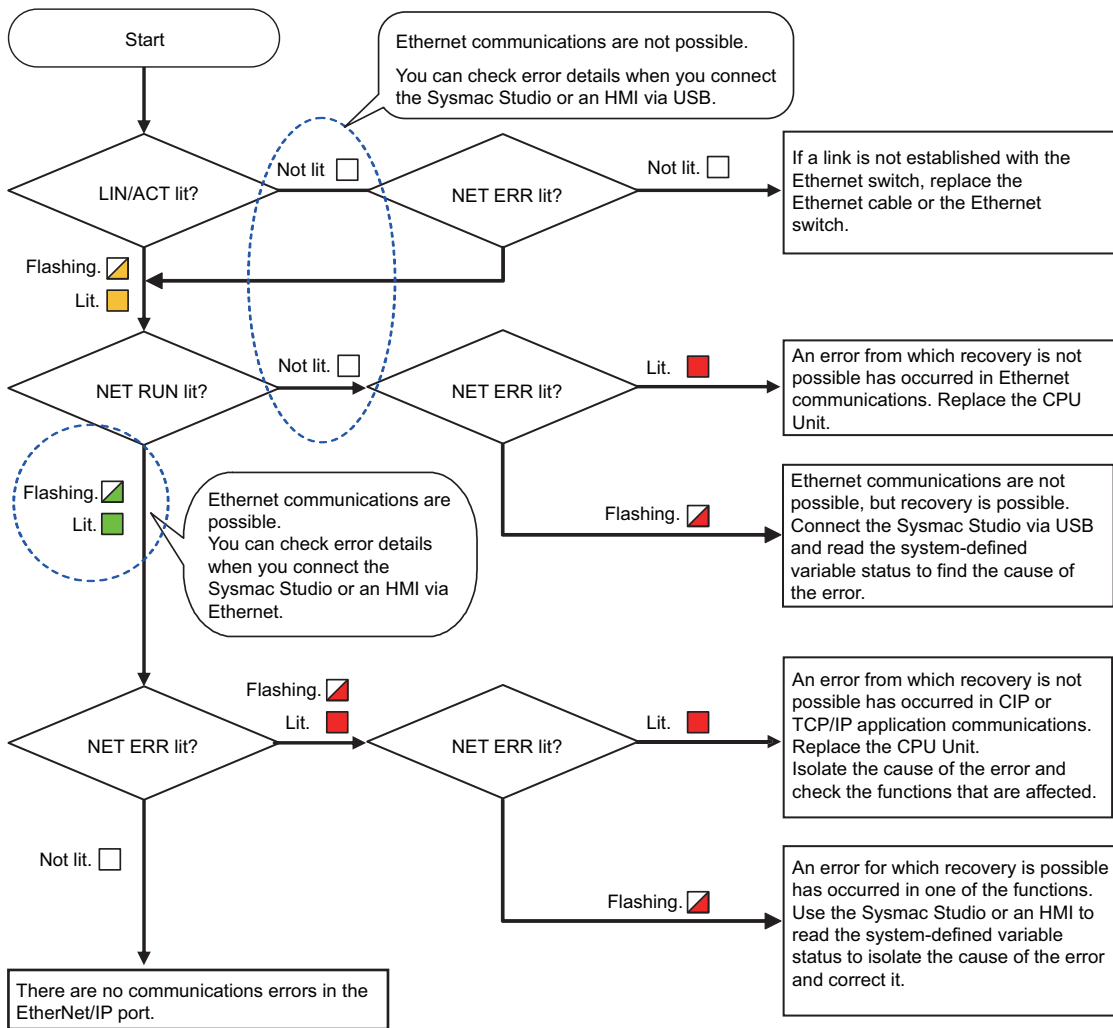

2-2 Troubleshooting Fatal Errors

The section describes the procedure to troubleshoot fatal errors in the CPU Unit.

● Power Supply Error

Cause	Correction
Power is not being input.	Turn ON the power.
The voltage is outside of the allowable range for the power supply.	Check the Controller's power supply system, and correct it so that the voltage is within the allowable range.
Power supply system error caused by mounted Unit	Remove the Units from the CPU Rack one by one. If the error is eliminated, replace that Unit.
Power Supply Unit failure (CPU Units other than NX102 and NX1P2)	If the error persists even after you make the above corrections, replace the Power Supply Unit.
Power supply section failure (NX102 CPU Unit or NX1P2 CPU Unit)	If the error persists even after you make the above corrections, replace the CPU Unit.

● System Initialization Error

Cause	Correction
A conductive object has gotten inside.	If there is conductive material nearby, blow out the CPU Unit with air.
Noise	If the error did not result from the above causes, cycle the power to the Controller and see if that resets the error. If the error occurs frequently, check the FG and power supply lines to see if noise is entering on them. Implement noise countermeasures as required.
CPU Unit failure	If the error persists even after you make the above corrections, replace the CPU Unit.

● CPU Unit Reset

Cause	Correction
A conductive object has gotten inside.	If there is conductive material nearby, blow out the CPU Unit with air.
The power supply to an Expansion Rack is OFF.	Supply the correct voltage to the Power Supply Unit on the Expansion Rack.
The I/O Connecting Cable is incorrectly installed.	Correct the connection of the I/O Connecting Cable.
Noise	If the error did not result from the above causes, cycle the power to the Controller and see if that resets the error. If the error occurs frequently, check the FG and power supply lines to see if noise is entering on them. Implement noise countermeasures as required.
Power Supply Unit failure	If the error persists even after you make the above corrections, replace the Power Supply Unit.
CPU Unit failure	If the error persists even after you make the above corrections, replace the CPU Unit.

● Hardware Initialization Error

Cause	Correction
A conductive object has gotten inside.	If there is conductive material nearby, blow out the CPU Unit with air.
Noise	If the error did not result from the above causes, cycle the power to the Controller and see if that resets the error. If the error occurs frequently, check the FG and power supply lines to see if noise is entering on them. Implement noise countermeasures as required.
CPU Unit failure	If the error persists even after you make the above corrections, replace the CPU Unit.

● Incorrect Power Supply Unit Connected

Cause	Correction
A CJ-series Power Supply Unit is connected to an NJ-series CPU Unit.	Connect an NJ-series Power Supply Unit to the NJ-series CPU Unit.

● CPU Unit Error

Cause	Correction
A conductive object has gotten inside.	If there is conductive material nearby, blow out the CPU Unit with air.
Noise	If the error did not result from the above causes, cycle the power to the Controller and see if that resets the error. If the error occurs frequently, check the FG and power supply lines to see if noise is entering on them. Implement noise countermeasures as required.
CPU Unit failure	If the error persists even after you make the above corrections, replace the CPU Unit.

● CPU Unit Watchdog Timer Error

Cause	Correction
A conductive object has gotten inside.	If there is conductive material nearby, blow out the CPU Unit with air.
Noise	If the error did not result from the above causes, cycle the power to the Controller and see if that resets the error. If the error occurs frequently, check the FG and power supply lines to see if noise is entering on them. Implement noise countermeasures as required.
CPU Unit failure	If the error persists even after you make the above corrections, replace the CPU Unit.

2-3 Troubleshooting Non-fatal Errors

2-3-1 Identifying and Resetting Errors with the Sysmac Studio

Troubleshooting functions are provided by the Sysmac Studio.

You can use the troubleshooting functions to identify errors that occur in a Controller, and reset the errors.

Displaying Errors on the Sysmac Studio

If an error occurs while the Sysmac Studio is online with the Controller, the Sysmac Studio notifies the user of the error in the Controller Status Pane. From there, you can open the Troubleshooting and Event Logs Window to read detailed error information and troubleshooting methods.

Click the **Troubleshooting** Button in the toolbar, or select **Troubleshooting** from the **Tools** Menu.

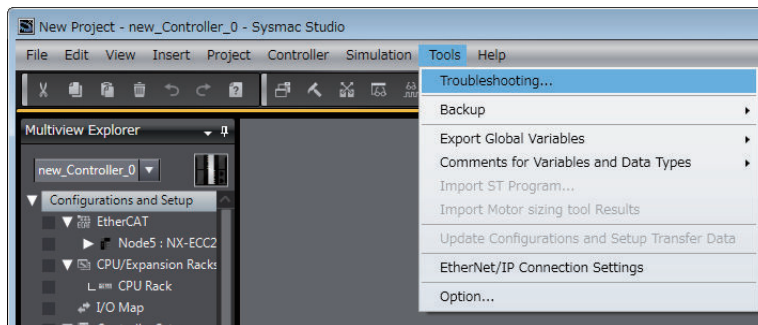

The Sysmac Studio automatically collects the Controller's error information, and opens the **Troubleshooting** Dialog Box.

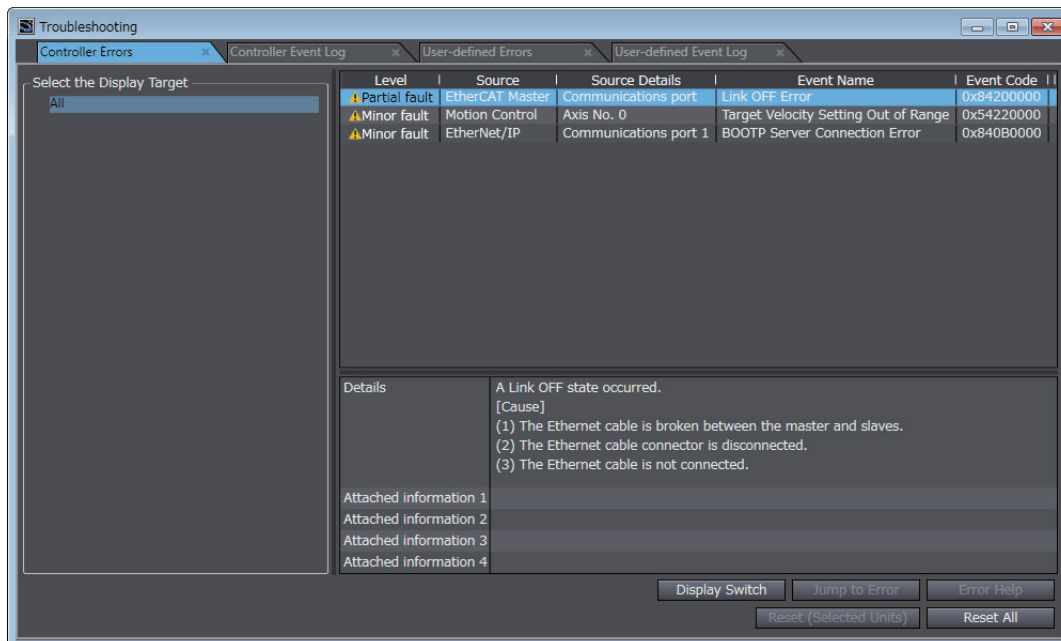

Checking Current Errors and the Event Logs with the Sysmac Studio

● Checking Current Errors with the Sysmac Studio

You can click the **Controller Errors** Tab in the **Troubleshooting** Dialog Box to read information on current errors in the Controller.

The **Controller Errors** Tab Page lists the current errors in order of their levels.

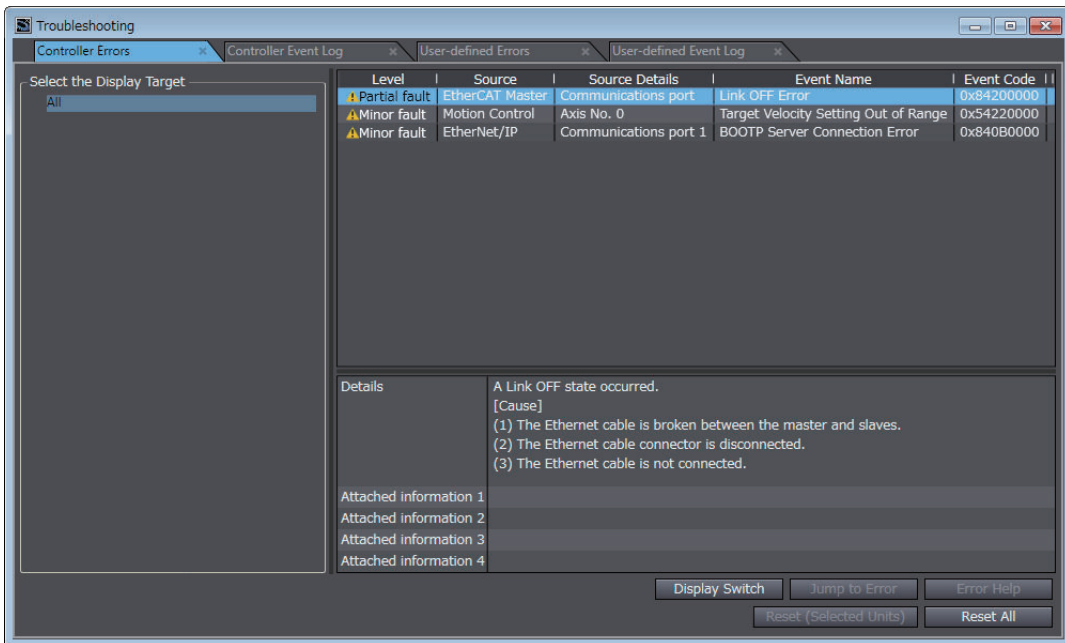

Displayed Item	Description
Level	This is the event level of the error.
Source and Source Details	This is the physical location and functional location of the error.
Event Name	Error name
Event Code	This is the code of the error.

You can click the column headings in the Controller error list, such as the **Level** or **Source**, to reorder the table rows according to that heading.

For example, the following change occurs when you click the **Source** heading.

Before **Source** heading is clicked.

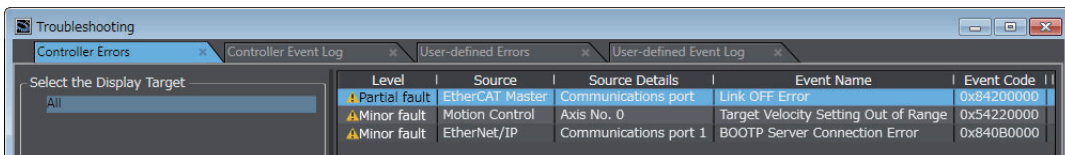

After **Source** heading is clicked.

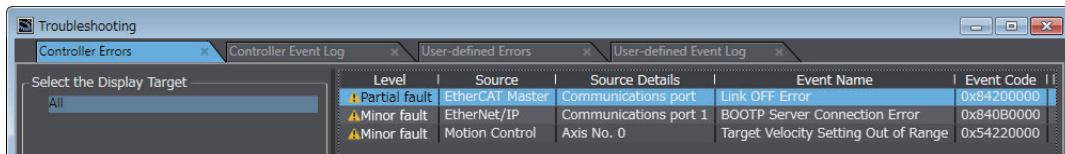

Additional Information

Sysmac Studio provides the function to display on the network configuration information the current errors whose source is the EtherCAT Master Function Module. This function is used to identify the error slave and the cause of the error. Refer to the descriptions on identifying an error slave and cause of error in the *NJ/NX-series CPU Unit Built-in EtherCAT Port User's Manual (Cat. No. W505)* for details.

● Displaying Event Logs with the Sysmac Studio

With Sysmac Studio, you can check a log of the Controller events that previously occurred on the **Controller Event Log** Tab Page.

You can select the event logs and levels to display in the Display Settings Area.

Information on the event that you specified are displayed in the Details Pane.

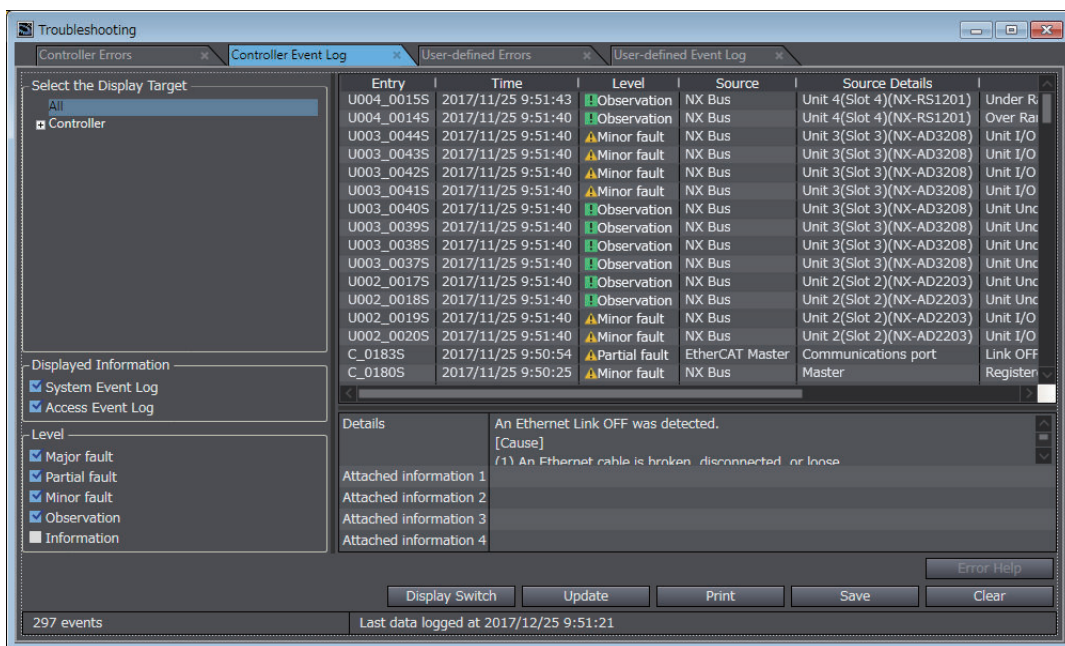

Error logs from CJ-series Special Units are displayed on the **Controller Event Log** Tab Page. Detailed information is not displayed. To check detailed information, use the event codes that are displayed and refer to the error codes that are given in the manual for the relevant Unit. The relationship between error codes and event codes is described in *Details on Controller Events (Errors and Information)* on page 1-15 under *1-3-1 Types of Non-fatal Errors* on page 1-12.



Additional Information

- The Sysmac Studio is provided with a function for displaying logs of events whose source is the EtherCAT Master Function Module in the network configuration information. This function is used for identifying the slave where an error occurred and the cause of the error. For the description of the function, refer to the descriptions related to the identification of the slave where an error occurred and the cause of the error in the *NJ/NX-series CPU Unit Built-in EtherCAT Port User's Manual (Cat. No. W505)*.
- You can also save an event log in a file and display it offline in the Event Log Viewer. For details on the Event Log Viewer, refer to the *Sysmac Studio Version 1 Operation Manual (Cat. No. W504)*.

Resetting Errors with the Sysmac Studio

You can use the Sysmac Studio to reset errors that occur in a Controller.

With a CPU Unit with unit version 1.05 or later and Sysmac Studio version 1.06 or higher you can also reset errors for individual Units.

Before you attempt to reset a Controller error, isolate and remove the cause of the error.

The Troubleshooting Dialog Box displays the cause, source, and corrections for the error. You can select any of the items from the error list to display the following information about that error.

Click the **Display Switch** Button to switch between displaying details and attached information and displaying actions and corrections.

Displayed item	Description
Details	Detailed information on the error is displayed, such as the probable causes.
Attached information 1 through 4	Detailed information about the source of the error is displayed.
Action and Correction	Methods to correct the probable causes of the error are displayed.

After confirming the cause of the displayed error and the conditions in which it occurred, perform the displayed error corrections to eliminate the cause of the error.

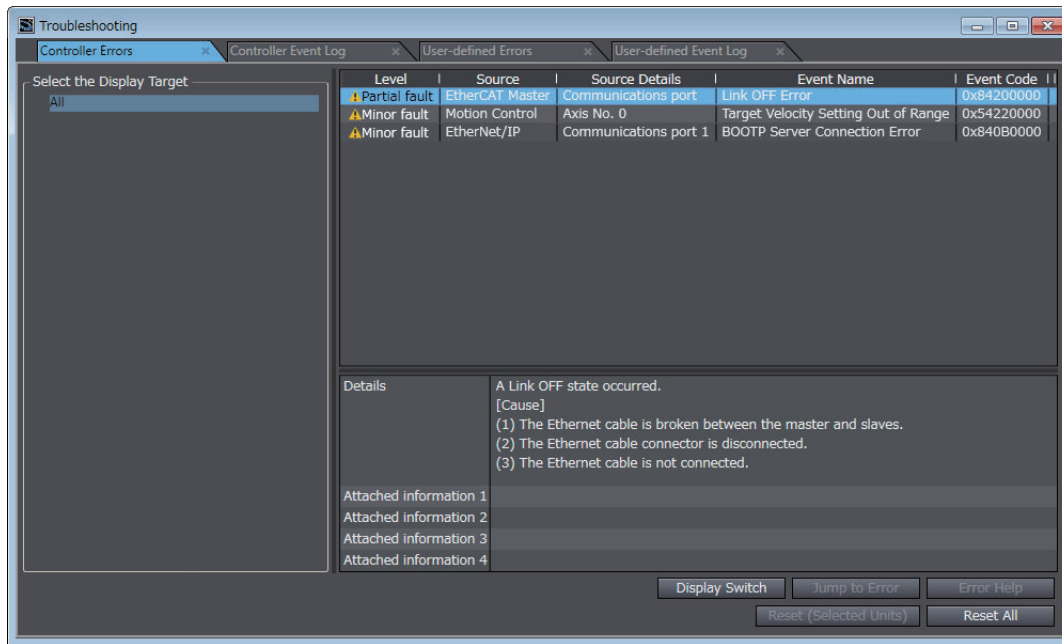

To eliminate the cause of the error, first select the item to perform from the Action and Correction list. When you select the appropriate step in the Action and Correction list, either the **Jump to Error** or **Error Help** Button is enabled, depending on the contents. In some cases, neither button will operate. Click the enabled button, and proceed with the displayed troubleshooting steps.

After you complete all of the troubleshooting steps for the current errors, click the **Reset (Selected Units)** or **Reset All** Button to reset all of the current errors.

If the cause of the error is not removed, or if the power supply is not cycled or the Controller is not reset as required after resetting the error, the error will occur again.

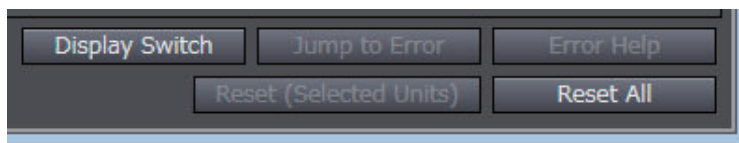

Button	Description
Jump to Error	This button is enabled when the error correction involves a change in the Sysmac Studio settings. When you click the button, the Sysmac Studio will automatically switch to the Editing Pane.
Error Help	The correction methods or the attached information is displayed if it is not possible to jump to the settings display.
Reset (Selected Units)	This button resets the current errors in the selected Unit.
Reset All	This button resets all of the current errors, and reads errors again.

It is necessary to synchronize the data between the Sysmac Studio and the connected CPU Unit before you use the **Jump to Error** Button.

For details on synchronization, refer to the *Sysmac Studio Version 1 Operation Manual (Cat. No. W504)*.

If you have enabled the verification of operation authority, it is necessary to confirm your authority before you can reset Controller errors.

The Operator, Maintainer, Designer, and Administrator have the authority to reset errors. For an Operator, however, verification is required each time.

Refer to the *NJ/NX-series CPU Unit Software User's Manual (Cat. No. W501)* for information on operation authority.

The Controller errors in all function modules are reset when you reset the Controller from the Sysmac Studio.

If the cause of the error is not removed, the error will occur again.

2-3-2 Identifying and Resetting Errors with an HMI

You can connect an OMRON HMI to an NJ/NX-series CPU Unit through an EtherNet/IP network, and use it to read and reset errors that occurred in the Controller. (The Troubleshooter of the HMI is used.) To perform troubleshooting from an HMI, connect the HMI to the built-in EtherNet/IP port on the CPU Unit.



Precautions for Correct Use

Refer to *A-5 Applicable Range of the HMI Troubleshooter* on page A-300 for the applicable range of the HMI Troubleshooter.

Checking for Current Errors with an HMI

You can check for errors in the Controller using the Troubleshooter of an HMI. You can also use the Troubleshooter to read detailed error information and corrections for current errors.

Refer to the relevant HMI manual for details on the HMI Troubleshooter.

The following example demonstrates the procedure used to check for errors with an NA-series HMI.

You can check the names and status of all connected Controllers in the Controller Status Screen of the NJ/NX Troubleshooter of the NA-series HMI. If there is an error, *Error* is displayed as the status of the Controller.

Controllers	Controller Event Status	User Event Status
new_Controller_0	Error	Normal
new_Controller_1	Normal	Normal

Buttons: Show Controller Events, Show User Events

Select the Controller with an error and click the **Show Controller Events** Button to display the Controller Event List Screen. In the Controller Event List Screen, you can check the list of Controller errors that currently exist in the selected Controller.

NJ/NX Troubleshooter 5/13/2016 5:10:56 PM Exit

Active Events

Controller Events User Events Back

Event Source: All Change

Event Level	Event Source	Event Code	Event Name
Partial fault	EtherCAT - Communications port	0x84200000	Link OFF Error
Partial fault	EtherNet/IP - Communications port	0x84010000	IP Address Duplication Error
Minor fault	PLC	0x000B0000	Low Battery Voltage
Minor fault	EtherNet/IP - Communications port	0x84030000	DNS Server Connection Error

Screen Shot Error Reset Show Detail

RUN new_Controller_0 (192.168.250.1)

Resetting Errors with an HMI

You can use the Troubleshooter in an HMI to reset errors that occur in the Controller. Before you attempt to reset a Controller error, identify and remove the cause of the error.

The following example demonstrates the procedure used to check for errors with an NA-series HMI.

Select an event in the Controller Event List Screen and click the **Show Detail** Button to display error causes and corrections. In the Details Screen, information such as the error causes and corrections are displayed.

After you confirm the cause of the displayed error, perform the steps in the displayed correction.

NJ/NX Troubleshooter 5/13/2016 5:11:46 PM

Event Name: IP Address Duplication Error Back

Event Code: 0x84010000 Date/Time: 5/13/2016 4:28:15 PM

Event Source: EtherNet/IP - Communications port

Event Level: Partial fault

Detailed Information

The same IP address is used more than once.
[Cause]
The IP address of the built-in EtherNet/IP port is also used as the IP address of another node.
[Attached information 1]
Duplicated IP address (example: 0xC0A8FA01 = address 192.168.250.1)

Attached Info 1: 0xC0A8FA01

Attached Info 2:

Attached Info 3:

Attached Info 4:

Screen Shot

RUN new_Controller_0 (192.168.250.1)

After you complete all of the correction steps for the current errors, click the **Error Reset** Button in the Controller Event List Screen to reset all of the current errors.

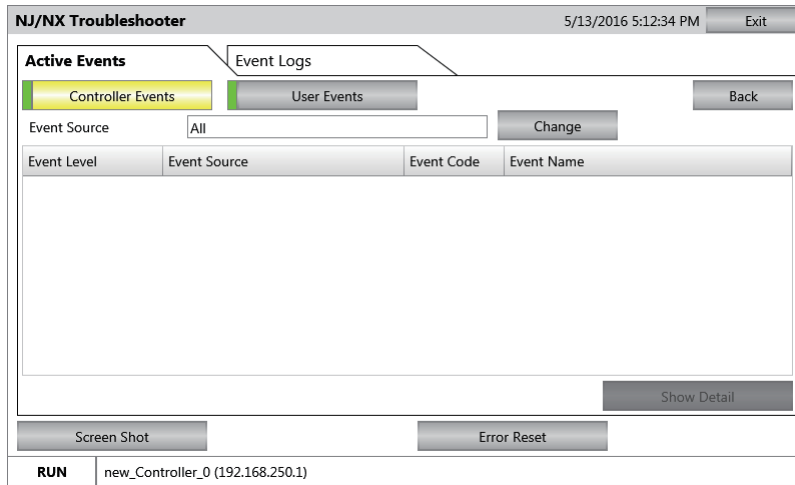

Return to the Controller Status Screen and check the Controller status. The status of the Controller whose errors were completely reset is displayed as “Normal”.

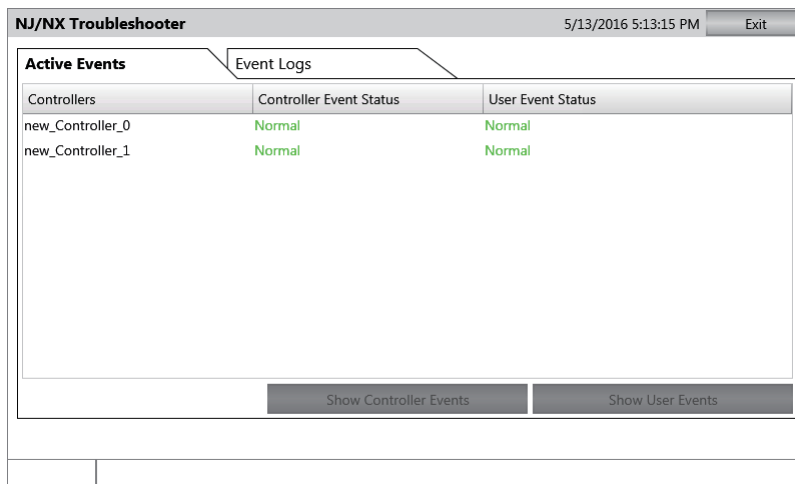

If the cause of the error is not removed, or if the power supply is not cycled or the Controller is not reset as required after resetting the error, the error will occur again.

Refer to the relevant HMI manual for details on the HMI Troubleshooter.

2-3-3 Identifying and Resetting Errors from the User Program

In a Controller, you can check for errors that have occurred from the user program. This feature allows you to program operations in the user program according to the error status. Special instructions are provided for this purpose.

These include instructions to get Controller error information and instructions to reset Controller errors.

Instructions That Get Controller Error Information

Determine the error status with the instruction to get error information that is provided for each function module.

The following table lists the instruction that are used to get error information for each function module.

Instruction name	Instruction	Function
Get PLC Controller Error Status	GetPLCError	Gets the status and the event code of the error with the highest level of the Controller errors in the PLC Function Module.
Get I/O Bus Error Status	GetCJBError	Gets the status and the event code of the error with the highest level of the Controller errors in the I/O bus of the NJ-series CPU Unit.
Get NX Bus Error Status	GetNXBError	Gets the highest level status of all current Controller errors in the NX Bus Function Module of the NX-series CPU Unit.
Get NX Unit Error Status	GetNXUnitError	Gets the highest level status and highest level event code of the current Controller errors in the specified NX bus master or NX Unit in the NX Bus Function Module of an NX-series CPU Unit.
Get X Bus Error Status	GetXBError	Gets the highest level status of the Controller errors in the X Bus Unit.
Get X Bus Unit Error Status	GetXBUnitError	Gets the highest level status and highest level event code of the current Controller errors in the Unit on the X Bus.
Get Motion Control Error Status	GetMCErr	Gets the status and the event code of the error with the highest level of the Controller errors in the Motion Control Function Module.
Get EtherNet/IP Error Status	GetEIPErr	Gets the status and the event code of the error with the highest level of the Controller errors in the EtherNet/IP Function Module.
Get EtherCAT Error Status	GetECErr	Gets the status and the event code of the error with the highest level of the communications port errors and master errors detected by the EtherCAT Master Function Module.

Refer to *NJ/NX-series Instructions Reference Manual (Cat. No. W502)* for details on these instructions.

Example of Error Detection for the EtherCAT Master Function Module

Name	Data type	Initial value	Comment
Trigger	BOOL	FALSE	Get Condition

Name	Data type	Initial value	Comment
EC_Error	BOOL	FALSE	EtherCAT Master Error Flag

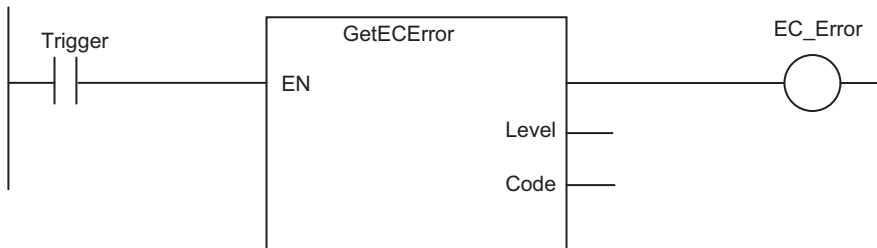

Resetting Controller Errors with Instructions

You can use the instructions that are provided to reset errors in the user program to reset errors that occur in the Controller.

Before you attempt to reset a Controller error, isolate and remove the cause of the error.

Reset the errors with the instruction provided to reset errors for each function module.

Instruction name	Instruction	Function
Reset PLC Controller Error	ResetPLCError	Resets current Controller errors from the PLC Function Module.
Reset I/O Bus Controller Error	ResetCJBError	Resets current Controller errors from the I/O bus of the NJ-series CPU Unit.
Reset NX Bus Error	ResetNXBError	Resets the current Controller errors in the NX Bus Function Module.
Reset X Bus Unit Error	ResetXBUnitError	Resets Controller errors in the Unit on the X Bus.
Reset Motion Control Error	ResetMCErr	Resets current Controller errors from the Motion Control Function Module.
Reset EtherCAT Error	ResetECErr	Resets current Controller errors from the EtherCAT Master Function Module.

Refer to the *NJ/NX-series Instructions Reference Manual (Cat. No. W502)* for details on these instructions.

2-3-4 Checking for Errors with System-defined Variables

The system-defined variables include an Error Status variable, which shows the error status in a hierarchical structure. The system determines the error status of each level by logically ORing the error status information of the next lower level.

You can read the Error Status variable from an external device through communications.

Refer to the *NJ/NX-series CPU Unit Software User's Manual (Cat. No. W501)* for information on system-defined variables.

- **NX-series CPU Units**

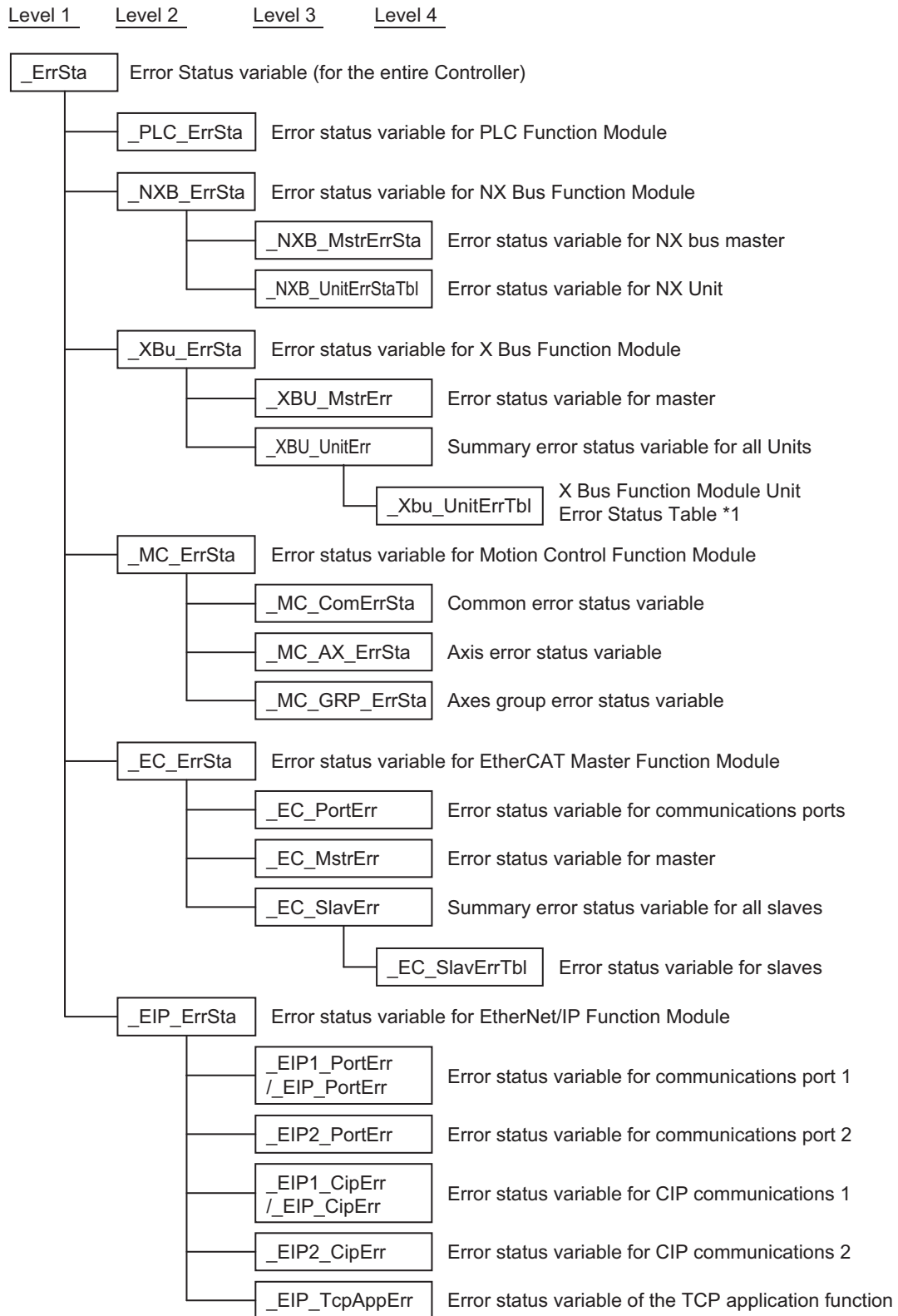

*1. There are device variables under this variable. Refer to the manuals for the X Bus Units for more information on device variables.

● NJ-series CPU Units

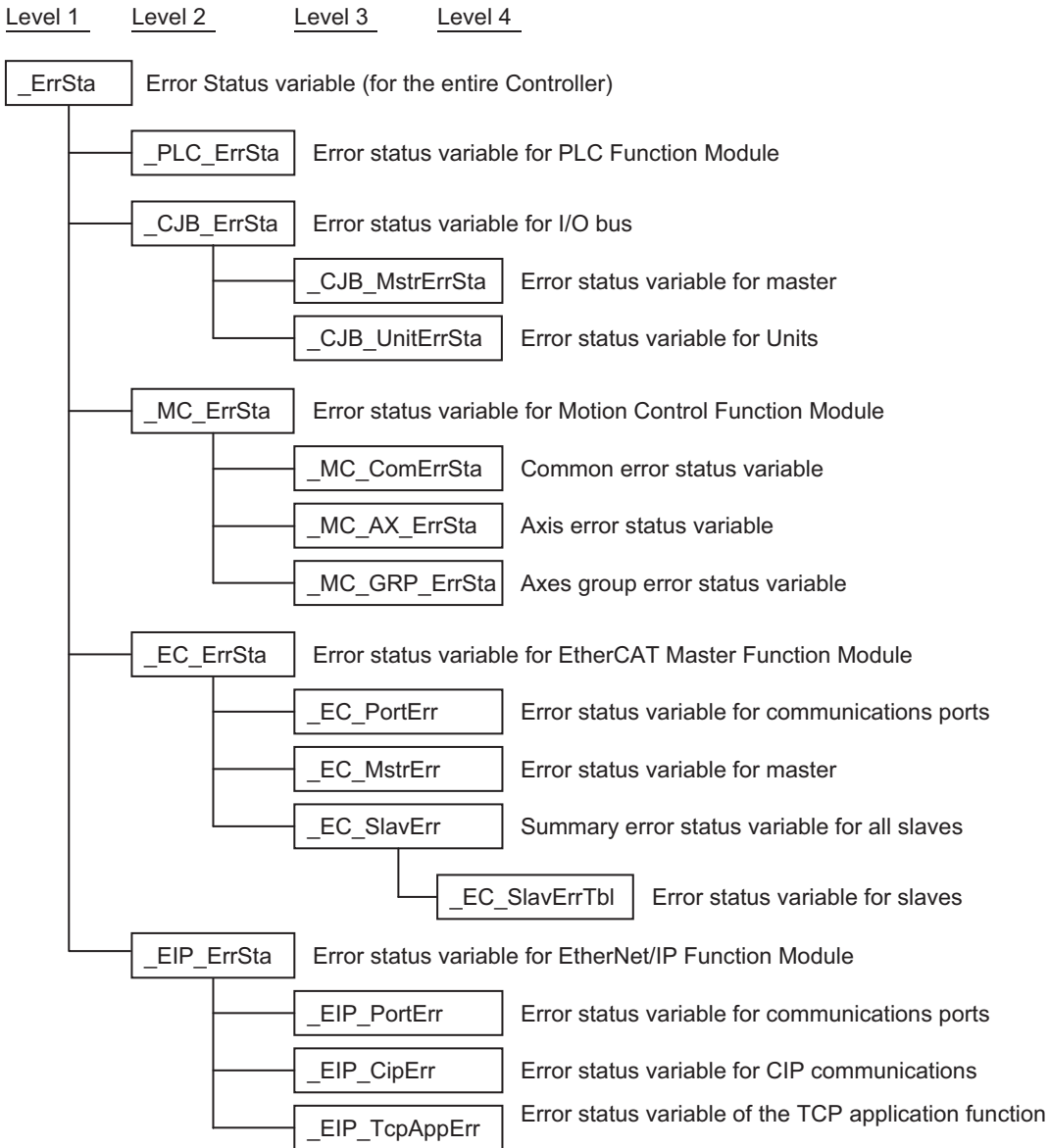

2-4 Troubleshooting When Support Software Cannot Go Online

This section describes the corrective actions when the support software cannot be connected online.

2-4-1 Troubleshooting When You Cannot Go Online from the Sysmac Studio

The section describes the procedure to troubleshoot when you cannot go online with the CPU Unit from the Sysmac Studio.

Causes and Correction When You Cannot Go Online from the Sysmac Studio

The following table lists the possible causes when you cannot go online with the CPU Unit from the Sysmac Studio.

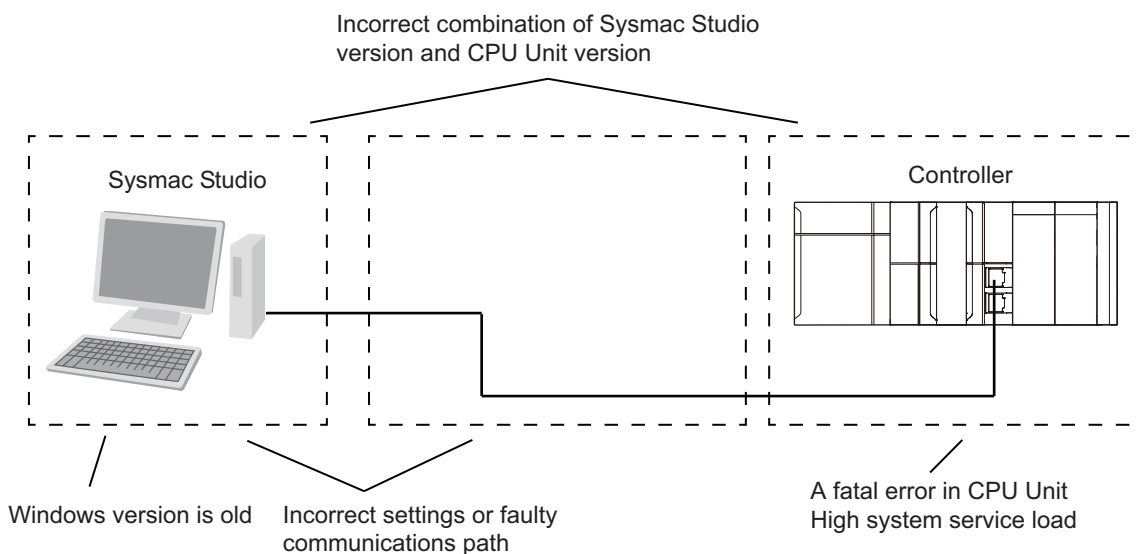

Cause	Description	Correction
Incorrect settings or faulty communications path	There is a mistake in the settings that the Sysmac Studio uses to go online with the CPU Unit. Or, the communications path is faulty.	Refer to <i>Troubleshooting Incorrect Settings and Faulty Communications Path</i> on page 2-27.

Cause	Description	Correction
Inconsistent support for secure communications between Sysmac Studio and CPU Unit	For CPU Units that support secure communication, prepare and use Sysmac Studio that supports secure communication.	<p>Either use the Sysmac Studio that supports secure communication, or set the DIP switch of the CPU Unit to <i>allow connection from the Sysmac Studio or an NA-series Programmable Terminal that does not support secure communication</i>.</p> <p>However, when the CPU Unit is set to secure communications version 2, setting the DIP switch to <i>allow connection from the Sysmac Studio or an NA-series Programmable Terminal that does not support secure communication</i> does not allow online connection.</p> <ul style="list-style-type: none"> Go online using the Sysmac Studio that supports secure communications version 2. To use secure communications version 1 on a CPU Unit that is set to use secure communications version 2, go online as a user with administrator privileges using the Sysmac Studio that supports secure communications version 2 and change the setting to secure communications version 1. <p>Refer to the <i>NJ/NX-series CPU Unit Software User's Manual (Cat. No. W501)</i> for information on the CPU Unit models and unit versions that support secure communication, and corresponding Sysmac Studio versions.</p>
Windows version is old	On Windows 10 Version 1709 and lower, Sysmac Studio cannot connect to a CPU Unit that supports secure communication.	<p>To connect online to a CPU Unit that supports secure communication, use Sysmac Studio on Windows 10 Version 1803 or higher OS on the computer.</p> <p>Or, do both of the following:</p> <ul style="list-style-type: none"> Set the DIP switch of the CPU Unit to <i>allow connections from Sysmac Studio or an NA-series Programmable Terminal that do not support secure communication</i>, and then restart the CPU Unit. For information on setting the DIP switch, refer to the description of the DIP switch in the hardware user's manual of the CPU Unit. Restore the backup file created on a CPU Unit that does not support secure communication using an SD Memory Card to a CPU Unit that supports secure communication.
Fatal error in the CPU Unit	A fatal error occurred in the CPU Unit.	Refer to <i>2-1-1 Checking to See If the CPU Unit Is Operating</i> on page 2-2.
High system service load*1	The system service load on the CPU Unit is too high and time to connect with the Sysmac Studio cannot be taken.	Start operation of the CPU Unit in Safe Mode. Refer to <i>Troubleshooting a High System Service Load</i> on page 2-35 for details.

*1. This applies to an NJ-series CPU Unit.

Note If the EtherNet/IP NET ERR indicator on the CPU Unit is lit or flashing, it is possible that you cannot go online through an EtherNet/IP route because of an error in the EtherNet/IP Function Module. If the CPU Unit has a peripheral (USB) port, see if you can go online with a direct USB connection. If the CPU Unit does not have a peripheral (USB) port, see if you can go online with a direct Ethernet connection.



Precautions for Correct Use

- If you connect an NX-series CPU Unit to the Sysmac Studio through an EtherNet/IP port, connect to communications port 1. You cannot connect the Sysmac Studio directly to communications port 2.
- When Packet Filter (Simple) is enabled on the NX102 CPU Unit, the following restrictions apply.
 - a) You cannot connect the Sysmac Studio installed on the computer with unregistered IP address which is not allowed to be connected. Confirm that the IP address of the computer to allow connection is registered correctly in advance.
 - b) You cannot connect the Sysmac Studio to the CPU Unit in **Direct connection via Ethernet**. Select **Controller - Communications Setup** to confirm that the connection type is *Ethernet connection via a hub*.
- If the **Do not use** Option for the CIP message server is selected, Sysmac Studio cannot be connected to the CPU Unit in **Remote connection via USB**.
- Incorrect setting of Packet Filter (Simple) or Packet Filter will prevent the Sysmac Studio from being connected to the CPU Unit. In that case, connect the Sysmac Studio with the NJ-series CPU Unit in direct connection via USB, and with the NX701 CPU Unit, NX102 CPU Unit, and NX1P2 CPU Unit in Safe Mode to review the setting.

You can use the status of the RUN indicator on the CPU Unit to isolate the cause. Implement the troubleshooting for the applicable cause.

○: Cause

RUN indicator	Cause		
	Incorrect settings or faulty communications path	Fatal errors in CPU Unit	High system service load ^{*3}
● (Not lit.)	○	○	---
◐ ^{*1} (Flashing at 2-s intervals.)	---	○ ^{*2}	---
◑ ^{*3} (Flashing at 3-s intervals.)	---	○ (Incorrect Power Supply Unit Connected.)	---
○ (Lit.)	○	---	○

*1. This applies to an NX-series CPU Unit.

*2. If the ERROR indicator is lit at the same time or if the RUN indicator flashes at a 2-second interval for more than 30 seconds, a fatal CPU Unit error has occurred.

*3. This applies to an NJ-series CPU Unit.

Troubleshooting for Each Cause

This section provides troubleshooting methods for *incorrect settings, faulty communications paths, and high system service loads.*

Troubleshooting Incorrect Settings and Faulty Communications Path

● Direct Connection via USB

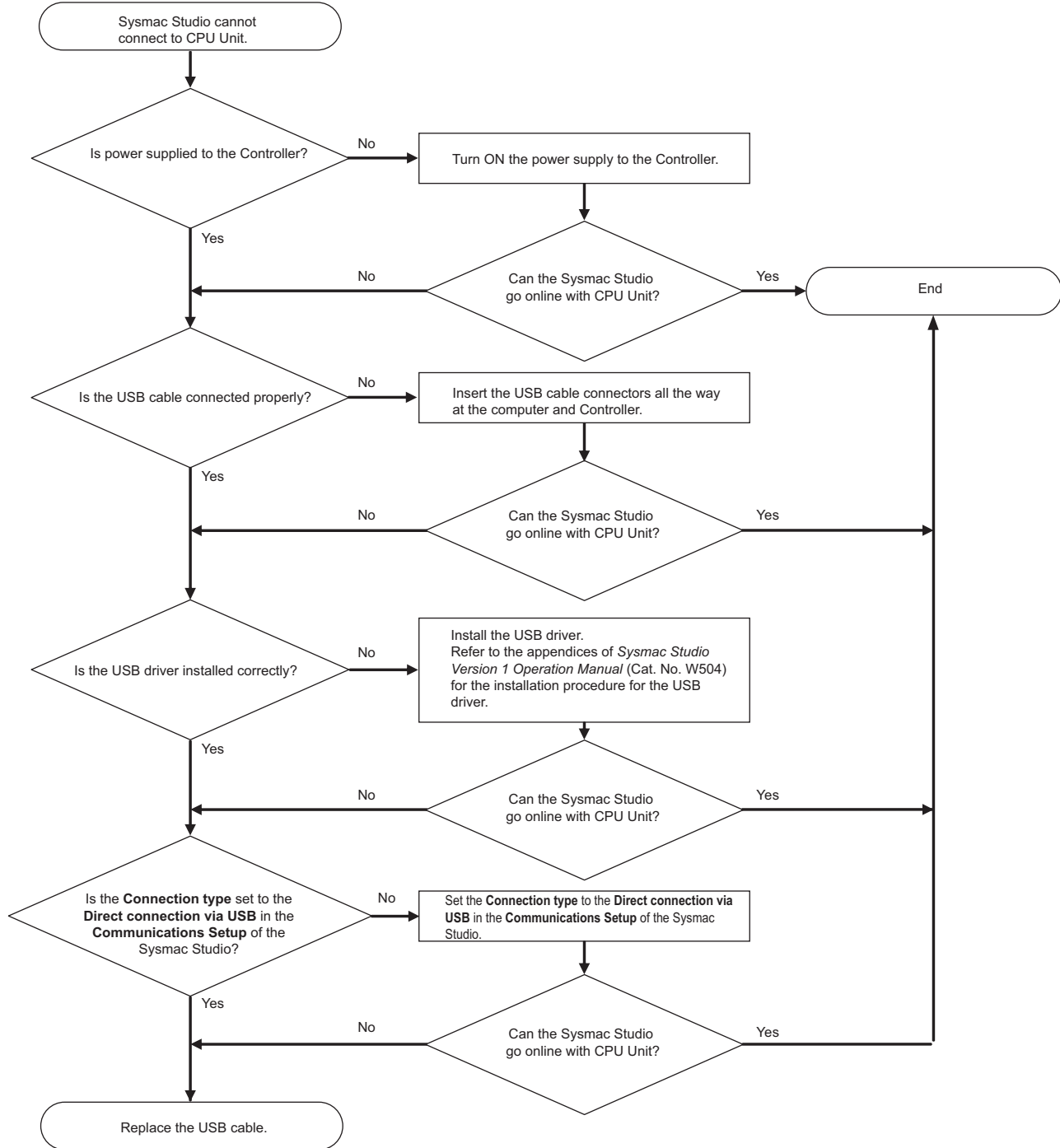

● Direct Connection via Ethernet

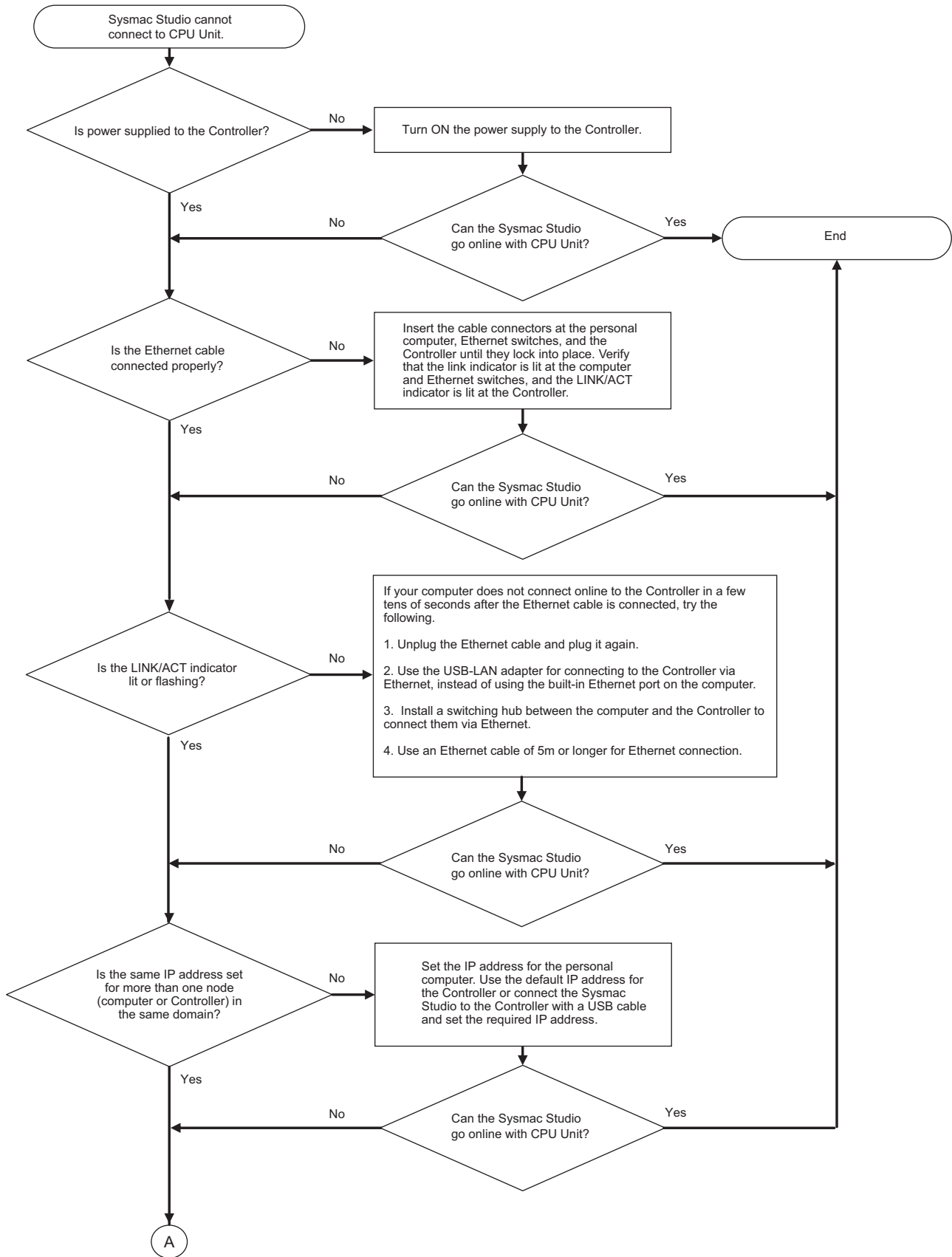

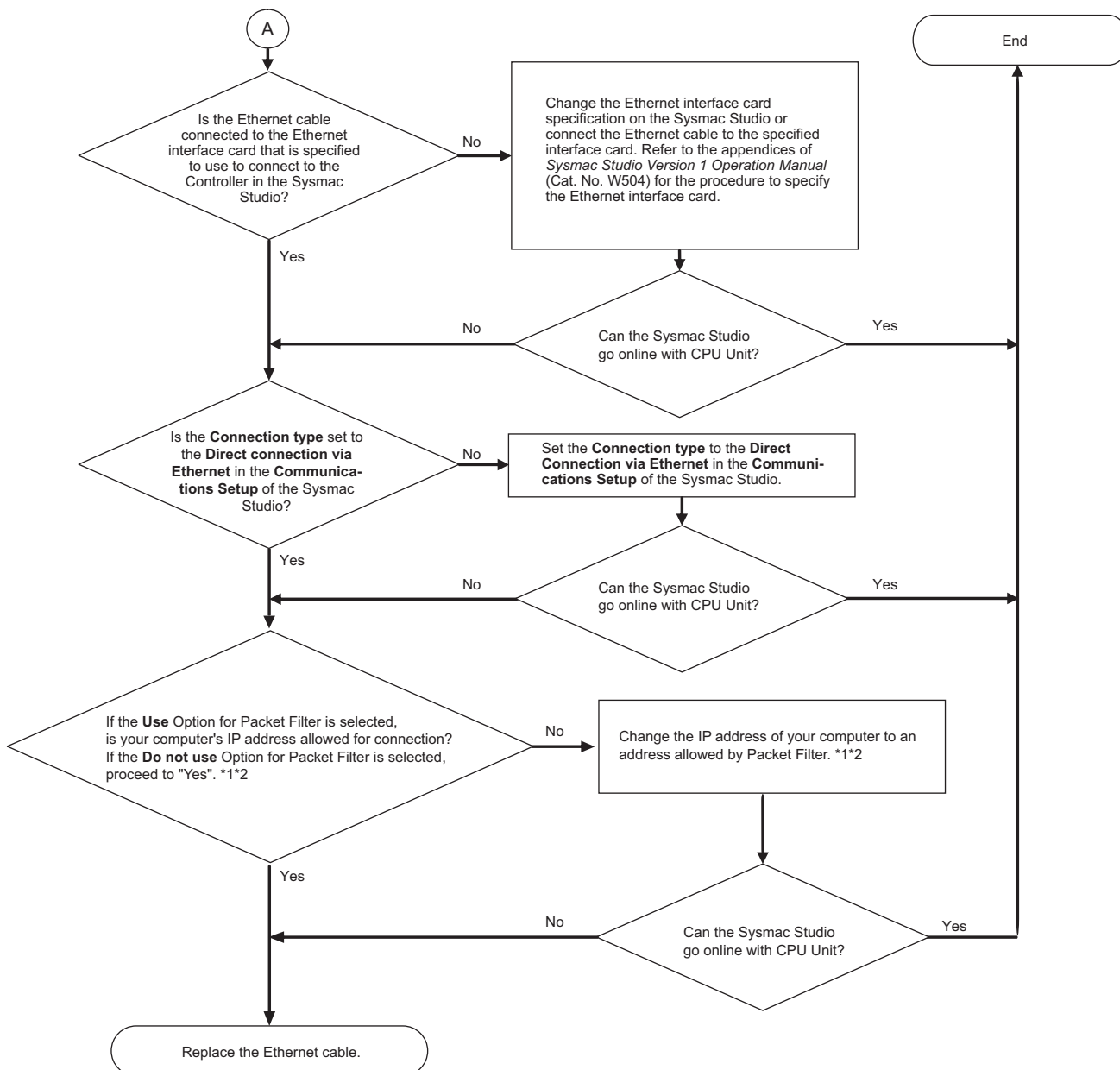

*1 For details on Packet Filter (Simple) setting and Packet Filter setting, refer to the *NJ/NX-series CPU Unit Built-in EtherNet/IP Port User's Manual* (Cat. No. W506).

*2 Incorrect setting of Packet Filter will prevent the Sysmac Studio from connecting to the CPU Unit. In that case, connect the Sysmac Studio with the NJ-series CPU Unit and the NX701 CPU Unit in direct connection via USB and with the NX502, NX102 and NX1P2 CPU Unit in Safe Mode. For details on Safe Mode, refer to *Troubleshooting Incorrect Settings of Packet Filter or Packet Filter (Simple)*.

● Remote Connection via USB

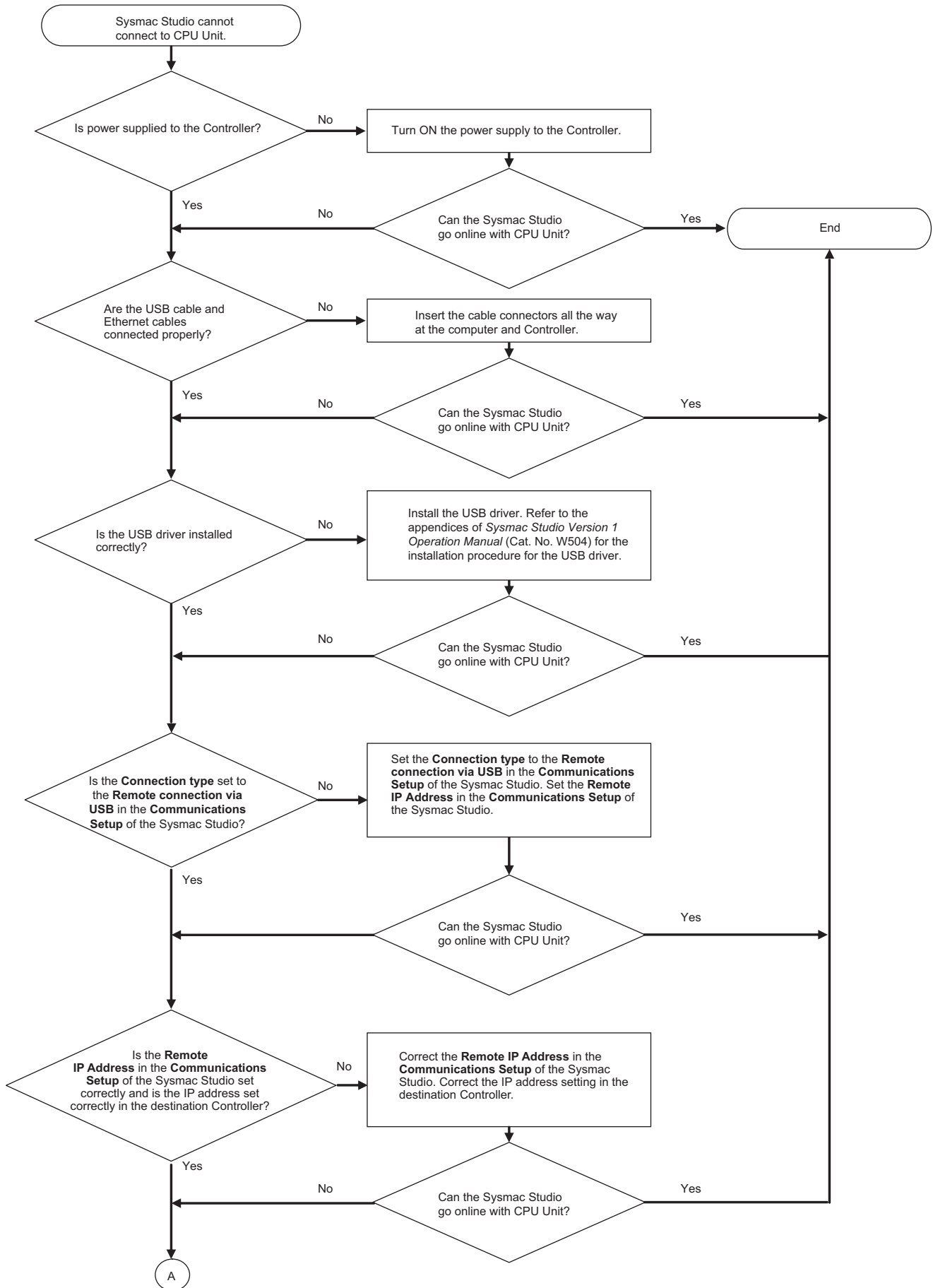

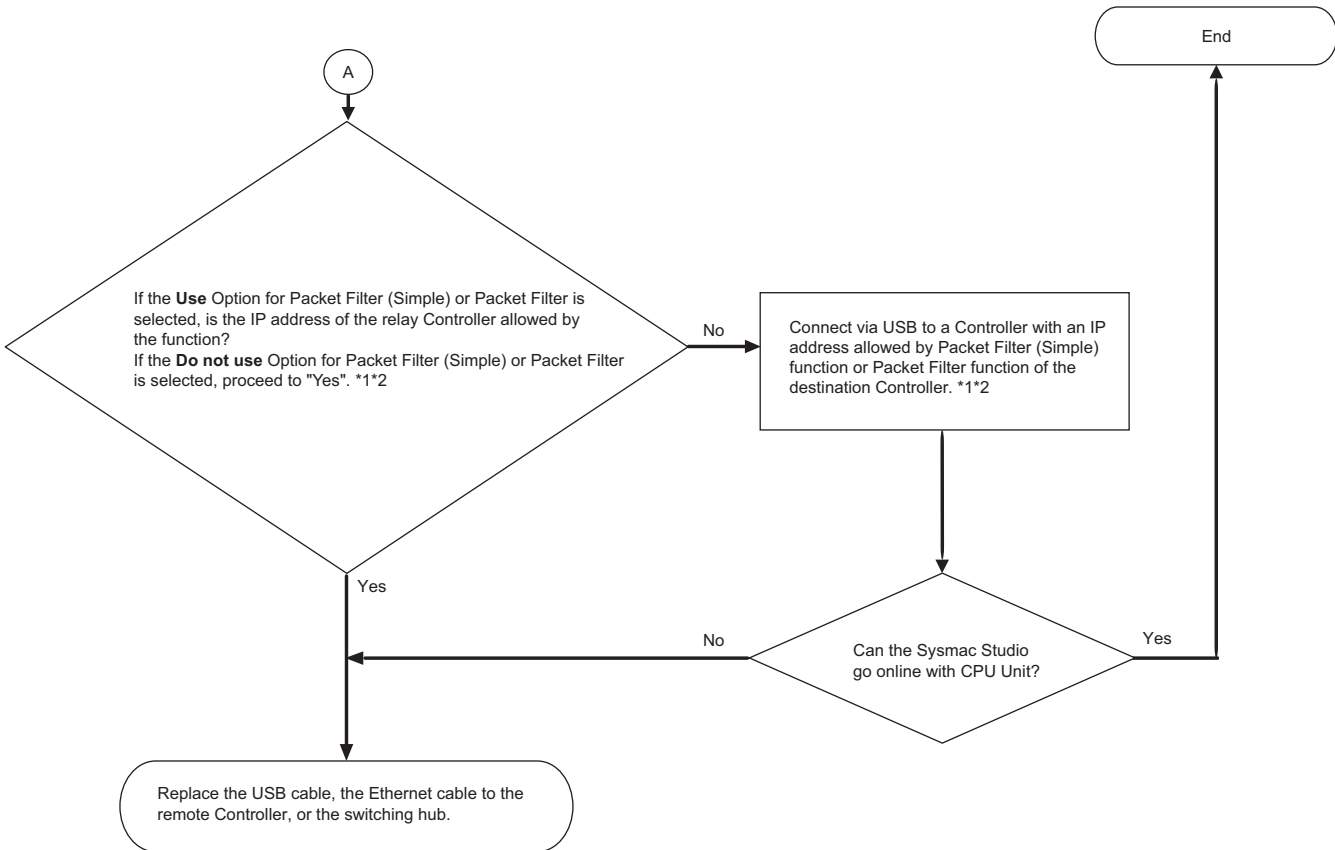

*1 For details on Packet Filter (Simple) setting and Packet Filter setting, refer to the *NJ/NX-series CPU Unit Built-in EtherNet/IP Port User's Manual* (Cat. No. W506).
 *2 Incorrect setting of Packet Filter (Simple) or Packet Filter will prevent the Sysmac Studio from connecting to the CPU Unit. In that case, connect the Sysmac Studio with the NJ-series CPU Unit and the NX701 CPU Unit in direct connection via USB and with the NX502, NX102 and NX1P2 CPU Unit in Safe Mode. For details on Safe Mode, refer to *Troubleshooting Incorrect Settings of Packet Filter or Packet Filter (Simple)*.

● Ethernet Connection via a Hub

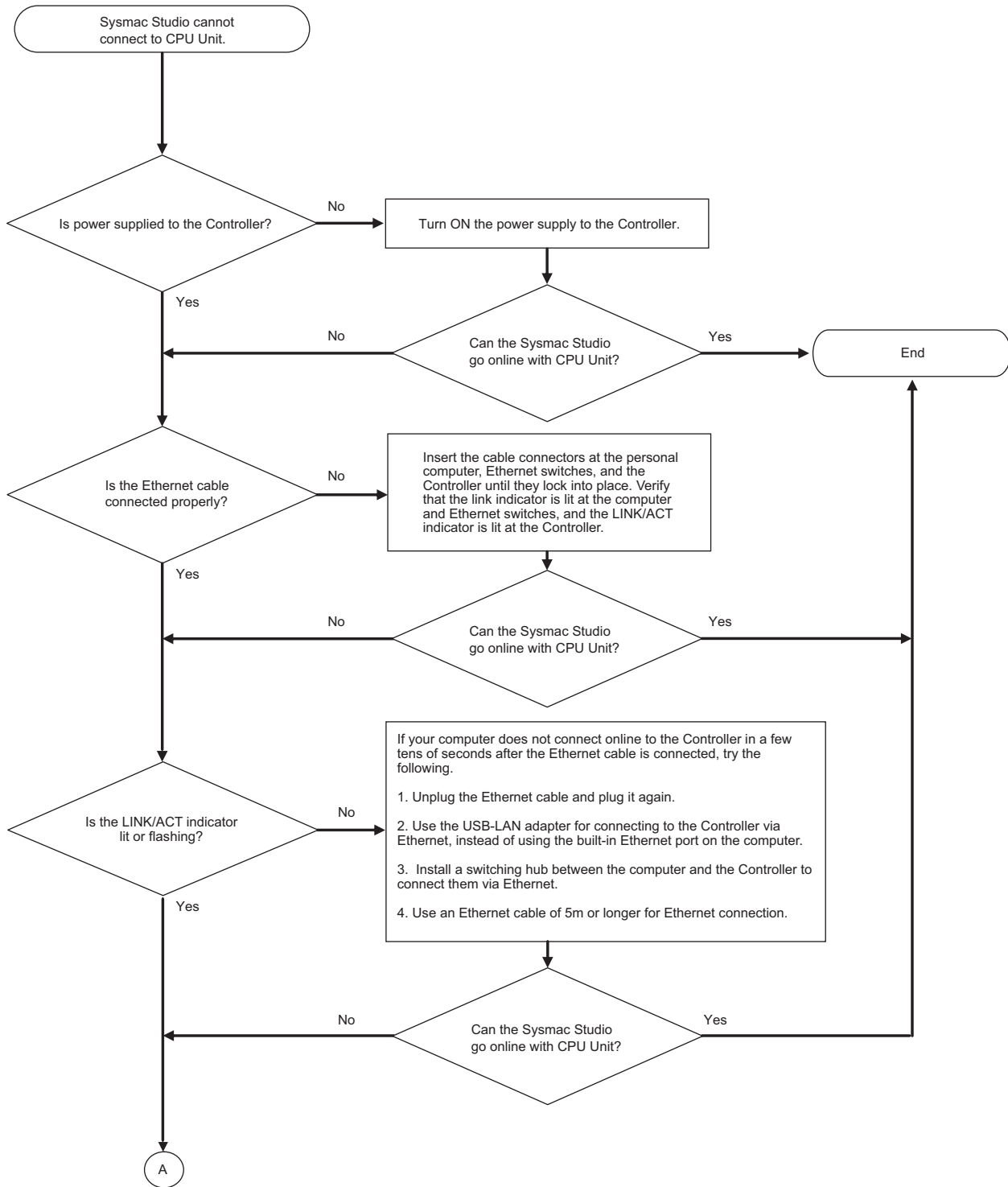

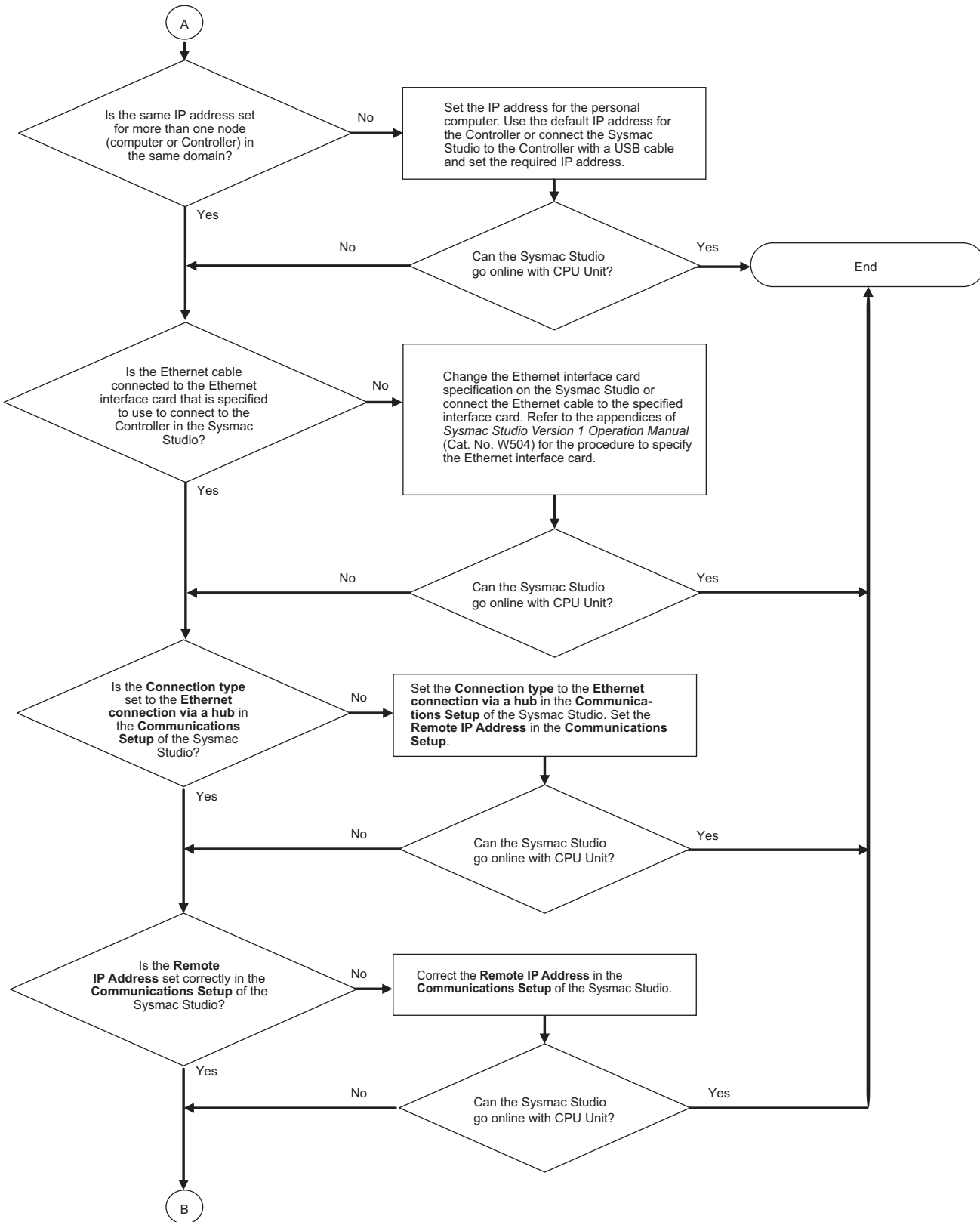

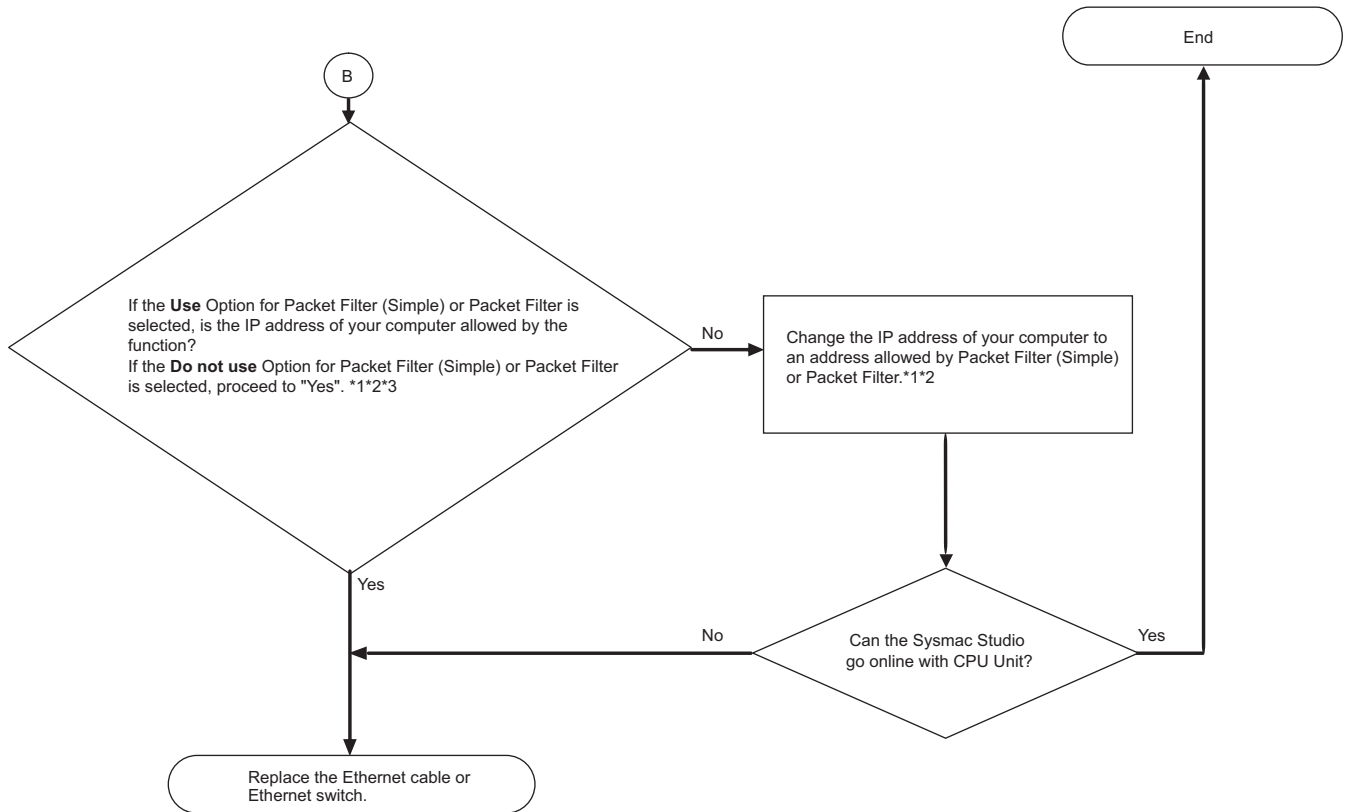

*1 For details on Packet Filter (Simple) setting and Packet Filter setting, refer to the *NJ/NX-series CPU Unit Built-in EtherNet/IP Port User's Manual* (Cat. No. W506).

*2 Incorrect setting of Packet Filter (Simple) or Packet Filter will prevent the Sysmac Studio from connecting to the CPU Unit. In that case, connect the Sysmac Studio with the NJ-series CPU Unit and the NX701 CPU Unit in direct connection via USB and with the NX502, NX102 and NX1P2 CPU Unit in Safe Mode. For details on Safe Mode, refer to *Troubleshooting Incorrect Settings of Packet Filter or Packet Filter (Simple)*.

*3 If you are connecting the Sysmac Studio to an X Bus Unit for which the Use Option is selected for Packet Filter, connect the Sysmac Studio through a built-in EtherNet/IP port in the CPU Unit and correct the Packet Filter settings of the X Bus Unit.

Troubleshooting a High System Service Load

In the NJ-series CPU Unit, a high throughput in task execution may cause the system service to enter a high-load state, and this may prevent the Sysmac Studio from connecting with the CPU Unit.

If a high system service load is the problem, you will be able to go online with the CPU Unit from the Sysmac Studio if you start in Safe Mode. Use the following procedure.

- 1 Set on the DIP switch on the CPU Unit as shown below and then cycle the power supply to the Controller.
The CPU Unit will start in Safe Mode.

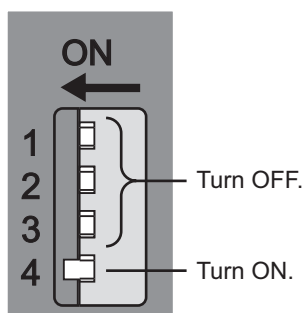

- 2 Go online with the CPU Unit from the Sysmac Studio and perform the required operation. Ensure that there is sufficient system service time to enable the Sysmac Studio to go online with the CPU Unit. To do so, either increase the period of the primary periodic task or decrease the sizes of the programs in the primary periodic task. Refer to the *NJ/NX-series CPU Unit Software User's Manual (Cat. No. W501)* for information on setting the primary periodic task.
- 3 Turn OFF all DIP switch pins and then cycle the power supply to the Controller to restore normal CPU Unit operation.

● Safe Mode Operation

If the Controller is started when the CPU Unit is in Safe Mode, the CPU Unit will start in PROGRAM mode even if the startup mode is set to RUN mode. This increases the ratio of system service processing that is performed by the CPU Unit, which makes it easier for the Sysmac Studio to go online with the CPU Unit. You can also use Safe Mode when you do not want to execute the user program.

The CPU Unit will generate an observation level Controller event and record a Safe Mode event in the event log.



Additional Information

Operation in Safe Mode depends on the unit version of the CPU Unit.

Item	Unit version of CPU Unit	
	1.02 or lower	1.03 or later
Operating mode	The CPU Unit operates according to the setting of the startup mode.	The CPU Unit ignores the setting of the startup mode and operates in PROGRAM mode.
Changing the operating mode	Not possible.	Possible.
Controller event level	Major fault level	Observation level

Troubleshooting Incorrect Settings of Packet Filter or Packet Filter (Simple)

Incorrect setting of Packet Filter or Packet Filter (Simple) will prevent the Sysmac Studio from connecting to the CPU Unit. Connect the Sysmac Studio to an NX502, NX102 or NX1P2 CPU Unit in Safe Mode and correct the Packet Filter settings or Packet Filter (Simple) settings.

- 1 Set the DIP switch of the CPU Unit as shown in the figure below, and then turn ON the power to the Controller again.
The CPU Unit starts up in Safe Mode.

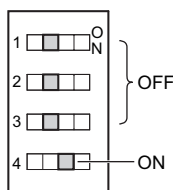

- 2 Go online with the CPU Unit from the Sysmac Studio and review the Packet Filter settings or Packet Filter (Simple) settings.
For the details on the settings, refer to *Packet Filter* or *Packet Filter (Simple)* in the *NJ/NX-series CPU Unit Built-in EtherNet/IP Port User's Manual (Cat. No. W506)*.
- 3 Turn OFF all DIP switch pins and then cycle the power supply to the Controller to restore normal CPU Unit operation.
- 4 Check whether the Sysmac Studio can go online with the CPU Unit.
Select **Controller - Communications Setup** to confirm that *Ethernet connection via a hub* is selected for connection method. If Packet Filter (Simple) is enabled, you cannot connect the Sysmac Studio in *Direct connection via Ethernet*.

● Safe Mode Operation

If the Controller is started in Safe Mode, Packet Filter and Packet Filter (Simple) are disabled. This allows you to go online the Sysmac Studio with the CPU Unit from a computer.

The CPU Unit will generate an observation level Controller event and record a Safe Mode event in the event log.

**Additional Information**

The safe mode operation is given below.

Item	Operation
Operating mode	The CPU Unit ignores the setting of the startup mode and operates in PROGRAM mode.
Changing the operating mode	Possible
Controller event level	Observation level

2-4-2 Troubleshooting When You Cannot Go Online from the Network Configurator

Refer to the *NJ/NX-series CPU Unit Built-in EtherNet/IP Port User's Manual (Cat. No. W506)* for actions to take when Network Configurator cannot go online with the CPU Unit.

2-4-3 Troubleshooting When You Cannot Go Online from the CX-Configurator FDT

Refer to the *IO-Link System User's Manual (Cat. No. W570)* or the *NXR-series IO-Link Master Unit for EtherNet/IP User's Manual (Cat. No. W619)* for actions to take when CX-Configurator FDT cannot go online with the CPU Unit.

2-4-4 Troubleshooting When You Cannot Go Online from the CX-Integrator

Refer to the *CS/CJ/CP/NSJ/NJ Series CX-Integrator Operation Manual (Cat. No. W464)* for actions to take when CX-Integrator cannot go online with the CPU Unit.

2-4-5 Troubleshooting When You Cannot Go Online from the CX-Protocol

Refer to the *CX-Protocol Operation Manual (Cat. No. W344)* for actions to take when CX-Protocol cannot go online with the CPU Unit.

3

Error Descriptions and Corrections

This section describes all of the errors (events) that can occur on NJ/NX-series CPU Units and corrections for these errors.

For errors (events) that can occur in models other than the standard CPU Units and the errors (events) that can occur in connected devices, only tables of errors are provided in *Appendices* on page A-1. Refer to the manual for the specific product for details on errors.

3-1	Interpreting Tables	3-3
3-1-1	Interpreting Error Table.....	3-3
3-1-2	Interpreting Error Descriptions	3-4
3-2	Errors in the PLC Function Module	3-6
3-2-1	Error Tables	3-6
3-2-2	Error Descriptions.....	3-95
3-2-3	Other Troubles and Corrections	3-430
3-3	Errors in the NX Bus Function Module	3-432
3-3-1	Error Tables	3-432
3-3-2	Error Descriptions.....	3-436
3-4	Errors in the X Bus Function Module	3-453
3-4-1	Error Tables	3-453
3-4-2	Error Descriptions.....	3-455
3-5	Errors in the X Bus Unit Common Function Module	3-465
3-5-1	Error Tables	3-465
3-5-2	Error Descriptions.....	3-469
3-6	Errors in the Motion Control Function Module.....	3-487
3-6-1	Error Tables	3-487
3-6-2	Error Descriptions.....	3-527
3-6-3	Other Troubles and Corrections	3-672
3-7	Errors in the EtherNet/IP Function Module.....	3-677
3-7-1	Error Tables	3-677
3-7-2	Error Descriptions.....	3-686
3-7-3	Other Troubles and Corrections	3-737
3-8	Errors in the EtherCAT Master Function Module	3-738
3-8-1	Error Tables	3-738
3-8-2	Error Descriptions.....	3-750
3-9	Errors in the OPC UA Function.....	3-818
3-9-1	Error Tables	3-818

3-9-2	Error Descriptions.....	3-828
3-9-3	OPC UA Server-specific Troubleshooting	3-854

3-1 Interpreting Tables

Within each source, errors (events) are given by functional classifications. Also, events that are not errors are given.



Additional Information

For descriptions of the error codes for the motion control instructions and other instructions, refer to the descriptions of the corresponding event codes. Events that occur for motion control instructions are given in *3-2 Errors in the PLC Function Module* on page 3-6. Events that occur for other instructions are given in *3-6 Errors in the Motion Control Function Module* on page 3-487. Refer to *Relationship between Event Codes and Error Codes* on page 1-26 for the relationship between event codes and error codes.

If events that occur are different according to versions, the versions for events that occur are given in the following expressions.

- For unit versions of CPU Units, "CPU Unit with unit version X.XX" or "Ver. X.XX"
 - For project unit versions^{*1}, "project unit version X.XX"
- *1. In this manual, the unit version set for a project is called "project unit version". A project unit version is set for a project in the Select Device Area of Project Properties Dialog Box on the Sysmac Studio.

3-1-1 Interpreting Error Table

The contents of the error tables are described below.

Item	Description
Event code	The event code of the error in the NJ/NX-series Controller is given. The codes are given in eight hexadecimal digits. A version in parentheses in the Event code column is the unit version of a CPU Unit or the project unit version where an event with the relevant event code occurs. A model name in square brackets in the Event code column is the CPU Unit when the event occurs. The model name is not described if the event occurs in all CPU Unit.
Event name	The name of the error is given
Meaning	A short description of the error is given.
Assumed cause	The assumed cause of the error is given
Level	The level of influence on control is given. The abbreviations have the following meanings. Maj: Major fault level Prt: Partial fault level Min: Minor fault level Obs: Observation Info: Information The symbols have the following meanings. ○: Event levels that are defined by the system. ⊙: Event levels that can be changed by the user. ^{*1}
Reference	The catalog number of the manual that provides details on the event is given. The manual name that corresponds to the manual number is given before each error table.

*1. This symbol appears only for events for which the user can change the event level.

3-1-2 Interpreting Error Descriptions

The items that are used to describe individual errors (events) are described in the following copy of an error table.

Event name	Gives the name of the error.		Event code	Gives the code of the error.		
Meaning	Gives a short description of the error.					
Source	Gives the source of the error.		Source details	Gives details on the source of the error.	Detection timing	Tells when the error is detected.
Error attributes	Level	Tells the level of influence on control. *1	Recovery	Gives the method to return to normal state after eliminating the cause of the error.	Log category	Tells which log the error is saved in. *2
Effects	User program	Tells what will happen to execution of the user program. *3	Operation	Provides special information on the operation that results from the error.		
Indicators/ Status	Gives the status you can check with the built-in EtherCAT port indicators or the built-in EtherNet/IP port indicators. Indicator status is given only for errors in the EtherCAT Master Function Module and the EtherNet/IP Function Module.					
System-defined variables	Variable	Data type		Name		
	Lists the variable names, data types, and meanings for system-defined variables that provide direct error notification, that are directly affected by the error, or that contain settings that cause the error. *4					
Cause and correction	Assumed cause		Correction		Prevention	
	Lists the possible causes, corrections, and preventive measures for the error.					
Attached information	This is the attached information that is displayed by the Sysmac Studio or an HMI. *5					
Precautions/ Remarks	Provides precautions, restrictions, and supplemental information. If the user can set the event level, the event levels that can be set, the recovery method, operational information, and other information is also provided.					
User name in the access log	Provides the name of the user who performed the operation that generates the access log. This information is provided only for errors (events) for which the user name is recorded in the access log.					

*1. One of the following:

- Major fault: Major fault level
- Partial fault: Partial fault level
- Minor fault: Minor fault level
- Observation
- Information

*2. One of the following:

- System: System event log
- Access: Access event log

*3. One of the following:

- Continues: Execution of the user program will continue.
- Stops: Execution of the user program stops.
- Starts: Execution of the user program starts.

*4. Device variables are also contained in this section.

The differences between system-defined variables and device variables are as follows:

System-defined variable: The variable name starts with an underbar (_).

Device variable: The variable name starts with a character other than an underbar ().

- *5. Refer to *A-5 Applicable Range of the HMI Troubleshooter* on page A-300 for the applicable range of the HMI Troubleshooter.

3-2 Errors in the PLC Function Module

The section provides tables of the errors (events) that can occur in the PLC Function Module. They are divided into the following functional classifications.

- Self-diagnosis
- CJ-series Unit configuration
- Built-in I/O, Option Boards
- Tasks
- Controller operation
- FINS communications
- Instructions



Additional Information

- Instruction events are supported by CPU Units with unit version 1.02 or later.
- To create instruction events, you must select **Use** for **Event Log Settings - Instruction Error Output** on the Controller Setup. With the default setting, instructions events are not output. Sysmac Studio version 1.03 or higher is required to use the Event Log Settings.

3-2-1 Error Tables

Errors for Self Diagnosis

Event code	Event name	Meaning	Assumed cause	Level					Reference
				M a j	P r t	M i n	O b s	I n f o	
00090000 hex	DIP Switch Setting Error	An error was detected in the DIP switch setting.	• There is an error in the DIP switch setting.	○					page 3-95
000D0000 hex	Internal Bus Check Error	A fatal error was detected on the internal bus.	• A conductive material has gotten inside. • Noise • The CPU Unit has failed.	○					page 3-96
000E0000 hex	Non-volatile Memory Life Exceeded	The specified number of deletions for non-volatile memory was exceeded. Or, the number of bad blocks in memory exceeded the specified value.	• Non-volatile memory life expired.	○					page 3-97
00110000 hex [NX502, NX701]	CPU Unit Overheat (Operation Stopped)	Operation was stopped because the temperature inside the CPU Unit was too high.	• The ambient operating temperature is too high.	○					page 3-98

Event code	Event name	Meaning	Assumed cause	Level					Reference
				M a j	P r t	M i n	O b s	I n f o	
00130000 hex (Ver. 1.13 or later) [NX102, NX1P2] (Ver. 1.60 or later) [NX502] (Ver. 1.16 or later) [NX701, NJ5 with hardware revision B] (Ver. 1.17 or later) [NJ3 with hardware revision A, NJ1 with hardware revision A]	Main Memory Check Error	An error was detected in the memory check of the main memory in the CPU Unit.	<ul style="list-style-type: none"> A conductive material has gotten inside. Noise There is a soft error. The CPU Unit has failed. 	○					page 3-99
10010000 hex	Non-volatile Memory Restored or Formatted	An error was detected in the non-volatile memory check and file system recovery or formatting was executed. Previous files may have been deleted.	<ul style="list-style-type: none"> The Controller power supply was turned OFF while the BUSY indicator was lit. The power supply to the Controller was interrupted momentarily while the BUSY indicator was lit. 	○					page 3-100
10020000 hex	Non-volatile Memory Data Corrupted	A file that must be in non-volatile memory is missing or corrupted.	<ul style="list-style-type: none"> The Controller power supply was turned OFF while the BUSY indicator was lit. The power supply to the Controller was interrupted momentarily while the BUSY indicator was lit. The CPU Unit has failed. 	○					page 3-101
10080000 hex	Main Memory Check Error	An error was detected in the memory check of the main memory in the CPU Unit.	<ul style="list-style-type: none"> A conductive material has gotten inside. Noise There is a soft error. The CPU Unit has failed. 	○					page 3-102
100A0000 hex (Ver. 1.10 or later) [NJ-series, NX701]	Data Not Saved to Battery-backup Memory	An error occurred in the software and data could not be saved in battery-backup memory during power-OFF processing.	<ul style="list-style-type: none"> An error occurred in the software. 	○					page 3-103
100B0000 hex	Non-volatile Memory Data Corrupted	A file that must be in non-volatile memory is missing or corrupted.	<ul style="list-style-type: none"> The Controller power supply was turned OFF while the BUSY indicator was lit. The power supply to the Controller was interrupted momentarily while the BUSY indicator was lit. The CPU Unit has failed. 	○					page 3-104

Event code	Event name	Meaning	Assumed cause	Level					Reference
				M a j	P r t	M i n	O b s	I n f o	
100C0000 hex (Ver. 1.03 or later)	Event Level Setting Error	The settings in the event level setting file are not correct.	<ul style="list-style-type: none"> The event level settings are not correct because the power supply to the Controller was interrupted or communications with the Sysmac Studio were disconnected during a download of the event level settings. The event level settings are not correct because the power supply to the Controller was interrupted during a Clear All Memory operation. Non-volatile memory failed. 	○					page 3-105
100F0000 hex [NX102, NX1P2, NX502]	Present Values of Retained Variables Restoration Error	The present values of retained variables could not be restored at startup and the values were initialized.	<ul style="list-style-type: none"> An error occurred in the software. Backup memory failure 	○					page 3-106
10100000 hex [NX102, NX1P2, NX502]	Present Values of Retained Variables Not Saved	The process of saving the current value of the retained variable during power interruptions could not be performed because an error occurred in the software.	<ul style="list-style-type: none"> An error occurred in the software. 	○					page 3-107
40010000 hex [NJ-series]	PLC System Processing Error	A fatal error was detected in the PLC Function Module.	<ul style="list-style-type: none"> An error occurred in the software. 	○					page 3-108
40020000 hex	PLC System Processing Error	A fatal error was detected in the PLC Function Module.	<ul style="list-style-type: none"> An error occurred in the software. 	○					page 3-108
40030000 hex	PLC System Processing Error	A fatal error was detected in the PLC Function Module.	<ul style="list-style-type: none"> An error occurred in the software. 	○					page 3-109
40040000 hex [NX701, NX1P2]	PLC System Processing Error	A fatal error was detected in the PLC Function Module.	<ul style="list-style-type: none"> An error occurred in the software. 	○					page 3-109
40050000 hex [NX701, NX1P2]	PLC System Processing Error	A fatal error was detected in the PLC Function Module.	<ul style="list-style-type: none"> An error occurred in the software. 	○					page 3-110
00070000 hex	Real-Time Clock Stopped	The oscillation of the real-time clock stopped. The real-time clock is set to an illegal time.	<ul style="list-style-type: none"> The battery voltage is low. The battery connector has come loose. The Battery is missing. 			○	⊙		page 3-110
00080000 hex	Real-Time Clock Failed	The real-time clock in the CPU Unit failed.	<ul style="list-style-type: none"> The CPU Unit clock has failed. 			○			page 3-111

Event code	Event name	Meaning	Assumed cause	Level					Reference
				M a j	P r t	M i n	O b s	I n f o	
000B0000 hex	Low Battery Voltage	The voltage of the Battery has dropped.	<ul style="list-style-type: none"> The battery voltage is low. The battery connector has come loose. The Battery is missing. 			○	○		page 3-111
000C0000 hex [NJ-series, NX502, NX701]	CPU Unit Overheat	The temperature inside the CPU Unit exceeded the specified value.	<ul style="list-style-type: none"> The ambient operating temperature is too high. 			○			page 3-112
00120000 hex [NX502, NX701]	Slow Fan	The speed of the fan dropped to a specified level or lower.	<ul style="list-style-type: none"> There is an obstacle that prevents the operation of the fan. The fan has reached the end of its service life. The fan is faulty. 			○	○		page 3-112
00150000 hex (Ver. 1.60 or later) [NJ-series, NX102, NX1P2, NX502] (Ver. 1.32 or later) [NX701]	Non-volatile Memory Life Warning	The warning number of deletions for non-volatile memory was exceeded. Or, the number of bad blocks in memory exceeded the warning value.	<ul style="list-style-type: none"> Non-volatile memory life expired. 			○	○		page 3-113
10090000 hex [NJ-series, NX701]	Battery-backup Memory Check Error	An error was detected in the memory check of the battery-backup memory in the CPU Unit.	<ul style="list-style-type: none"> The battery voltage is low. The battery connector has come loose. The Battery is missing. 			○	○		page 3-114
000F0000 hex	SD Memory Card Invalid Type	The current SD Memory Card is not supported.	<ul style="list-style-type: none"> An SD Memory Card that is not supported was inserted into the CPU Unit. 				○		page 3-115
00100000 hex	SD Memory Card Life Exceeded	The specified number of deletions for the SD Memory Card was exceeded. Or, the number of bad blocks exceeded the specified value.	<ul style="list-style-type: none"> The service life of the SD Memory Card was exceeded. 			○	○		page 3-116
10030000 hex	SD Memory Card Invalid Format	The file format of the SD Memory Card is not FAT16 or FAT32.	<ul style="list-style-type: none"> The file format of the SD Memory Card inserted in the CPU Unit is not FAT16 or FAT32. 				○		page 3-116
10040000 hex	SD Memory Card Restored or Formatted	An error was detected during the file system check and the file system was restored. Files may have been deleted.	<ul style="list-style-type: none"> The Controller power supply was turned OFF while the SD BUSY indicator was lit. The power supply to the Controller was interrupted momentarily while the SD BUSY indicator was lit. The SD Memory Card was removed while the SD PWR indicator was lit. The SD Memory Card is damaged. 			○	○		page 3-117

Event code	Event name	Meaning	Assumed cause	Level					Reference
				M a j	P r t	M i n	O b s	I n f o	
10060000 hex	SD Memory Card Data Corrupted	A file that must be in the SD Memory Card is missing or corrupted.	<ul style="list-style-type: none"> The Controller power supply was turned OFF while the SD BUSY indicator was lit. The power supply to the Controller was interrupted momentarily while the SD BUSY indicator was lit. The SD Memory Card was removed while the SD PWR indicator was lit. The SD Memory Card is damaged. 			○	○		page 3-118
10070000 hex	SD Memory Card Access Power OFF Error	The power supply to the Controller was interrupted during access to the SD Memory Card.	<ul style="list-style-type: none"> The Controller power supply was turned OFF while the SD BUSY indicator was lit. The power supply to the Controller was interrupted momentarily while the SD BUSY indicator was lit. 				○		page 3-119
10130000 hex [NX102, NX1P2]	PLC System Information	This event provides internal information from the PLC Function Module.	<ul style="list-style-type: none"> This event provides internal information from the PLC Function Module. It is recorded to provide additional information for another event. 				○		page 3-119
10310000 hex (Ver. 1.02 or later)	Incorrect SD Memory Card Removal	SD Memory Card removal processing failed.	<ul style="list-style-type: none"> The SD Memory Card was removed while the SD PWR indicator was lit. 				○		page 3-120

Errors Related to CJ-series Unit Configuration

Event code	Event name	Meaning	Assumed cause	Level					Reference
				M a j	P r t	M i n	O b s	I n f o	
04010000 hex [NJ-series]	I/O Bus Check Error	An error occurred in a bus line transmission between the CPU Unit and the Units in the rack slots. Or, detection of all Special I/O Units and CPU Bus Units was not completed when the power supply to the Controller was turned ON.	<ul style="list-style-type: none"> The I/O Connecting Cable is disconnected or wires inside it are broken. Conductive material has gotten inside. The connector contact is faulty due to foreign material in the connector. Noise A Unit has failed. 	○					page 3-121
24010000 hex [NJ-series]	Unsupported Unit Detect- ed	An unsupported CJ-series Unit or Power Supply Unit is mounted.	<ul style="list-style-type: none"> An unsupported CJ-series Unit or Power Supply Unit was detected. 	○					page 3-122
24020000 hex [NJ-series]	Too Many I/O Points	The total number of I/O points in the connected CJ-series Units exceeds the maximum specified value of the CPU Unit.	<ul style="list-style-type: none"> The total number of I/O points in the connected CJ-series Basic I/O Units exceeds 2,560. 	○					page 3-122
24030000 hex [NJ-series]	End Cover Missing	The End Cover is not connected to right end of the CPU Rack or an Expansion Rack.	<ul style="list-style-type: none"> The End Cover is not connected to right end of the CPU Rack or an Expansion Rack. The End Cover is not connected properly. 	○					page 3-123
24040000 hex [NJ-series]	Incorrect Unit/Expan- sion Rack Connection	The number of Units or Expansion Racks exceeds the maximum value specified for the CPU Unit. Or, an Interrupt Input Unit was mounted to a unsupported slot or to an Expansion Rack.	<ul style="list-style-type: none"> More than 10 Units are connected to one Rack. More than three Expansion Racks are connected. More than two Interrupt Input Units are mounted. An Interrupt Input Unit was mounted to a unsupported slot or to an Expansion Rack. 	○					page 3-123
24050000 hex [NJ-series]	Duplicate Unit Number	The same unit number is set for more than one Special I/O Unit or more than one CPU Bus Unit.	<ul style="list-style-type: none"> The same unit number is set for more than one Special I/O Unit or more than one CPU Bus Unit. The same unit number is assigned to a Special I/O Unit that uses more than one unit number and another Special I/O Unit. 	○					page 3-124

Event code	Event name	Meaning	Assumed cause	Level					Reference
				M a j	P r t	M i n	O b s	I n f o	
34010000 hex [NJ-series]	I/O Setting Check Error	There is an inconsistency between a Unit model in the Unit Configuration in the CPU Unit and the Unit model that is mounted in the Controller.	<ul style="list-style-type: none"> A Unit model or Special Unit unit number in the Unit Configuration in the CPU Unit is different from the Unit model or the Special Unit unit number of the Unit that is mounted in the Controller. 	○					page 3-125
44400000 hex [NJ-series]	PLC Function Processing Error	A fatal error was detected in the PLC Function Module.	<ul style="list-style-type: none"> An error occurred in the software. 	○					page 3-125
64010000 hex [NJ-series]	Impossible to Access Special Unit	An error occurred in data exchange between the CPU Unit and a Special Unit.	<ul style="list-style-type: none"> The setting of the rotary switches or a DIP switch pin on a Special Unit is not correct. An error occurred in the Special Unit. The Unit connection is faulty. Noise A Unit has failed. 			○			page 3-126
102D0000 hex (Ver. 1.03 or later) [NJ-series]	CJ-series Unit Backup Failed	The backup operation for a CJ-series Unit ended in an error.	<ul style="list-style-type: none"> An error occurred in the Unit Configuration. An error occurred for a Special Unit. A restart is in progress for the Special Unit. A Unit model or Special Unit unit number in the Unit Configuration in the CPU Unit is different from the Unit model or the Special Unit unit number of the Unit that is mounted in the Controller. The CPU Unit or CJ-series Unit has failed. 				○		page 3-127
102E0000 hex (Ver. 1.03 or later) [NJ-series]	CJ-series Unit Restore Operation Failed	The restore operation for a CJ-series Unit ended in an error.	<ul style="list-style-type: none"> An error occurred in the Unit Configuration. An error occurred for a Special Unit. The Unit Configuration in the backup file does not agree with the physical Unit configuration. A restart is in progress for the Special Unit. The restore conditions that are required by the Special Unit are not met. The backup files are corrupted. The CPU Unit or CJ-series Unit has failed. 				○		page 3-128

Event code	Event name	Meaning	Assumed cause	Level					Reference
				M a j	P r t	M i n	O b s	I n f o	
30200000 hex (Ver. 1.02 or later) [NJ-series]	Unsupported Unit Setting	A setting in the Special Unit is not supported.	<ul style="list-style-type: none"> A setting in the Special Unit is not supported by the CPU Unit. 				○		page 3-129
80010000 hex [NJ-series]	Illegal Packet Discarded	An illegal packet was received during message communications. The illegal packet was discarded.	<ul style="list-style-type: none"> Noise 				○		page 3-129
04020000 hex [NJ-series]	PLC System Information	This event provides internal information from the PLC Function Module.	<ul style="list-style-type: none"> This event provides internal information from the PLC Function Module. It is recorded to provide additional information for another event. 					○	page 3-130
44410000 hex [NJ-series]	PLC System Information	This event provides internal information from the PLC Function Module.	<ul style="list-style-type: none"> This event provides internal information from the PLC Function Module. It is recorded to provide additional information for another event. 					○	page 3-130

Built-in I/O and Option Boards

Event code	Event name	Meaning	Assumed cause	Level					Reference
				M a j	P r t	M i n	O b s	I n f o	
05440000 hex [NX1P2]	Option Board Error	An Option Board was removed or mounted during operation, or an Option Board hardware error occurred.	<ul style="list-style-type: none"> An Option Board was removed or mounted during operation. A hardware error was detected in an Option Board. 			○			page 3-131
35940000 hex [NX1P2]	Option Board Configuration Verification Error	The Option Board configuration setup does not agree with the actual configuration.	<ul style="list-style-type: none"> The Option Board configuration setup does not agree with the actual configuration. An Option Board is not mounted correctly. 			○			page 3-132
35950000 hex [NX1P2]	Unsupported Option Board Mounted	There is an unsupported Option Board in the actual configuration.	<ul style="list-style-type: none"> There is an unsupported Option Board in the actual configuration. 			○			page 3-132
88130000 hex [NX1P2]	Analog Option Board Startup Error	An error occurred when an Analog Option Board is started.	<ul style="list-style-type: none"> An Analog Option Board is not mounted correctly. Or an Analog Option Board failed. 			○			page 3-133
88140000 hex [NX1P2]	Analog Option Board Communications Error	A communications error occurred during Analog Option Board operation.	<ul style="list-style-type: none"> If the indicator on an Analog Option Board flashes, it means that an error occurred in communicating with the Analog Option Board during operation. If the indicator on an Analog Option Board is lit, it means that a WDT error occurred in the Analog Option Board. 			○			page 3-133

Errors Related to Tasks

Event code	Event name	Meaning	Assumed cause	Level					Reference
				M a j	P r t	M i n	O b s	I n f o	
60020000 hex	Task Execution Timeout	Task execution exceeded the timeout detection time.	<ul style="list-style-type: none"> The timeout detection time setting is too short. The task period setting is too short. A user program is too large. The number of times that processing is repeated is larger than expected. Task Priority Error Frequent Event Task Execution 	○					page 3-134
60030000 hex	I/O Refreshing Timeout Error	Consecutive I/O refresh failures occurred during the primary periodic task or periodic task period.	<ul style="list-style-type: none"> The task period setting is too short. Task Priority Error for Periodic Tasks and Event Tasks There are too many Units and slaves that perform I/O refresh in the task period. Frequent Event Task Execution 	○					page 3-135
60040000 hex	Insufficient System Service Time Error	The specified system service execution time could not be obtained.	<ul style="list-style-type: none"> There was not sufficient time to execute the tasks and tag data link service. The system service execution interval is too short or the system service execution time ratio is too long in the System Service Monitoring Settings. 	○					page 3-136
60010000 hex	Task Period Exceeded	Task execution was not completed during the set task period for the primary periodic task or a periodic task.	<ul style="list-style-type: none"> The task period setting is too short. A user program is too large. The number of times that processing is repeated is larger than expected. Task Priority Error for Periodic Tasks and Event Tasks Frequent Event Task Execution 			○			page 3-137
60050000 hex	Task Period Exceeded	Task execution was not completed during the set task period for the primary periodic task or fixed periodic task.	<ul style="list-style-type: none"> The task period setting is too short. A user program is too large. The number of times that processing is repeated is larger than expected. Task Priority Error for Periodic Tasks and Event Tasks Frequent Event Task Execution 				○		page 3-138

Errors Related to Controller Operation

Event code	Event name	Meaning	Assumed cause	Level					Reference
				M a j	P r t	M i n	O b s	I n f o	
1020000 hex	User Program/ Controller Configurations and Setup Transfer Error	The user program or Controller Configurations and Setup were not transferred correctly.	<ul style="list-style-type: none"> The user program or Controller Configurations and Setup are not correct because the power supply to the Controller was interrupted during a download of the user program or the Controller Configurations and Setup. The user program or Controller Configurations and Setup are not correct because the power supply to the Controller was interrupted during online editing. The user program or Controller Configurations and Setup are not correct because the power supply to the Controller was interrupted during a Clear All Memory operation. The user program or Controller Configurations and Setup are not correct because the power supply to the Controller was interrupted during a restore operation. The power supply to the Controller is not cycled, although it is required after a Clear All Memory operation. Non-volatile memory failed. 	○					page 3-139
1021000 hex	Illegal User Program Execution ID	The user program execution IDs set in the user program and in the CPU Unit do not match.	<ul style="list-style-type: none"> The user program execution IDs set in the user program and in the CPU Unit do not match. A user program execution ID is set in the CPU Unit but not in the user program. 	○					page 3-140
1024000 hex	Illegal User Program	The user program is not correct.	<ul style="list-style-type: none"> There are more than 8 nesting levels for functions or function blocks. 	○					page 3-141
1025000 hex	Illegal User Program/ Controller Configurations and Setup	The upper limit of the usable memory was exceeded or the user program or Controller Configurations and Setup is corrupted.	<ul style="list-style-type: none"> The upper limit of the data size was exceeded. The main memory capacity was exceeded. Non-volatile memory is deteriorating or has failed. 	○					page 3-142

Event code	Event name	Meaning	Assumed cause	Level					Reference
				M a j	P r t	M i n	O b s	I n f o	
10270000 hex (Ver. 1.03 or later)	Error in Starting Automatic Transfer	An error was detected in pre-execution checks for automatic transfer.	<ul style="list-style-type: none"> An SD Memory Card is not inserted. The SD Memory Card type is not correct. The format of the SD Memory Card is not correct. There is no autoload folder on the SD Memory Card. There are no backup files in the autoload folder on the SD Memory Card. Either the backup files in the autoload folder on the SD Memory Card are corrupted or required data is not in the backup files on the SD Memory Card. The unit version of the CPU Unit to which to transfer the files is older than the unit version of the backup files on the SD Memory Card. The model of the CPU Unit to which to transfer the files is not the same as the model of the CPU Unit of the backup files on the SD Memory Card. Recovery was executed for the SD Memory Card. The CPU Unit is write-protected. The settings in the automatic transfer command file (AutoloadCommand.ini) are not correct. Reading the data for automatic transfer failed because the SD Memory Card is faulty or not formatted correctly. The SD Memory Card is damaged. The database connection service version of the CPU Unit to which to transfer the files is older than the database connection service version of the backup files on the SD Memory Card. The robot version of the CPU Unit to which to transfer the files is older than the robot version of the backup files on the SD Memory Card. 	○					page 3-143

Event code	Event name	Meaning	Assumed cause	Level					Reference
				M a j	P r t	M i n	O b s	I n f o	
			<ul style="list-style-type: none"> The CPU Unit failed to process the power OFF during the last power interruption. An unexpected error has occurred. 						
10280000 hex (Ver. 1.03 or later)	Error in Executing Automatic Transfer	The automatic transfer ended in an error.	<ul style="list-style-type: none"> It was not possible to read the data for automatic transfer. The SD Memory Card was removed during an automatic transfer. There are no backup files in the autoload folder on the SD Memory Card. The backup files in the autoload folder on the SD Memory Card are corrupted. The SD Memory Card is damaged. An unexpected error has occurred. <p>Also check the following when you use the Robot Integrated CPU Unit.</p> <ul style="list-style-type: none"> The SD Memory Card is write protected. The capacity of the SD Memory Card is insufficient. The number of files or directories in the SD Memory Card exceeded the maximum number supported by the file system of the SD Memory Card. 						page 3-146

Event code	Event name	Meaning	Assumed cause	Level					Reference
				M a j	P r t	M i n	O b s	I n f o	
10330000 hex (Ver. 1.11 or later)	SD Memory Card Program Transfer Pre-execution Check Error	An error was detected in pre-execution checks for transferring SD Memory Card programs.	<ul style="list-style-type: none"> An SD Memory Card is not inserted. The SD Memory Card type is not correct. The format of the SD Memory Card is not correct. There is no such folder on the SD Memory Card as specified by the <code>_Card1PrgTransferCmd.DirName</code> system-defined variable. There are no backup files in such a folder on the SD Memory Card as specified by the <code>_Card1PrgTransferCmd.DirName</code> system-defined variable. Either the backup files in the folder specified by the <code>_Card1PrgTransferCmd.DirName</code> system-defined variable on the SD Memory Card are corrupted or required data is not in the backup files on the SD Memory Card. The unit version of the CPU Unit to which to transfer the files is older than the unit version of the backup files on the SD Memory Card. The model of the CPU Unit to which to transfer the files is not the same as the model of the CPU Unit of the backup files on the SD Memory Card. The CPU Unit is write-protected. Required files are not set to transfer in the setting of the <code>_Card1PrgTransferCmd</code> system-defined variable. Reading the data for the SD Memory Card program transfer failed because the SD Memory Card is faulty or not formatted correctly. The SD Memory Card is damaged. The CPU Unit failed to process the power OFF during the last power interruption. An unexpected error has occurred. 						page 3-148

Event code	Event name	Meaning	Assumed cause	Level					Reference
				M a j	P r t	M i n	O b s	I n f o	
			<ul style="list-style-type: none"> The database connection service version of the CPU Unit to which to transfer the files is older than the database connection service version of the backup files on the SD Memory Card. The robot version of the CPU Unit to which to transfer the files is older than the robot version of the backup files on the SD Memory Card. 						
10340000 hex (Ver. 1.11 or later)	Error in Executing SD Memory Card Program Transfer	The SD Memory Card program transfer ended in an error.	<ul style="list-style-type: none"> It was not possible to read the data for SD Memory Card program transfers. The SD Memory Card was removed during a SD Memory Card program transfer. There are no backup files in such a folder on the SD Memory Card as specified by the <code>_Card1PrgTransferCmd.Dir-Name</code> system-defined variable. The backup files in such a folder on the SD Memory Card as specified by the <code>_Card1PrgTransferCmd.Dir-Name</code> system-defined variable are corrupted. The SD Memory Card is damaged. An unexpected error has occurred. <p>Also check the following when you use the Robot Integrated CPU Unit.</p> <ul style="list-style-type: none"> The SD Memory Card is write protected. The capacity of the SD Memory Card is insufficient. The number of files or directories in the SD Memory Card exceeded the maximum number supported by the file system of the SD Memory Card. 						page 3-151

Event code	Event name	Meaning	Assumed cause	Level					Reference
				M a j	P r t	M i n	O b s	I n f o	
10650000 hex (Ver. 1.69 or later) [NJ-series] (Version 1.70 or later) [NX502, NX102, and NX1P2] (Version 1.37 or later) [NX701]	Security anomaly detection	The system has detected a security anomaly.	<ul style="list-style-type: none"> The system detected a security anomaly. 	○					page 3-152
40110000 hex	PLC Function Processing Error	A fatal error was detected in the PLC Function Module.	<ul style="list-style-type: none"> An error occurred in the software. 	○					page 3-153
40160000 hex (Ver. 1.02 or earlier) [NJ-series]	Safe Mode	The Controller started in Safe Mode.	<ul style="list-style-type: none"> The power supply was turned ON to the Controller when the Safe Mode was set on the DIP switch on the CPU Unit. 	○					page 3-153
44420000 hex (Ver. 1.05 or later)	PLC Function Processing Error	A fatal error was detected in the PLC Function Module.	<ul style="list-style-type: none"> An error occurred in the software. 	○					page 3-154
40120000 hex	PLC Function Processing Error	A fatal error was detected in the PLC Function Module.	<ul style="list-style-type: none"> An error occurred in the software. 		○				page 3-155
35EF0000Hex (Ver. 1.63 or later) [NX502]	Automation Playback Startup Error	The automation playback function cannot be started.	<ul style="list-style-type: none"> Settings to use the automation playback function are made for the CPU Unit that does not support the automation playback function. 			○			page 3-154
40130000 hex	PLC Function Processing Error	A fatal error was detected in part of the PLC Function Module.	<ul style="list-style-type: none"> An error occurred in the software. 			○			page 3-155
95770000 hex (Ver.1.63 or later earlier than Ver.1.65) [NX502]	Upper Limit of Variable Sampling	The upper limit for variable sampling has been reached.	<ul style="list-style-type: none"> The maximum number of variable sampling has been reached or size or processing capacity has exceeded the upper limit. 			○			page 3-156
95790000 hex (Ver.1.65 or later) [NX502]	Upper Limit of Variable Sampling	The upper limit for variable sampling has been reached.	<ul style="list-style-type: none"> The maximum number of variable sampling has been reached or size or processing capacity has exceeded the upper limit. 			○	⊙		page 3-157
10230000 hex	Event Log Save Error	Saving the event log failed.	<ul style="list-style-type: none"> A low battery voltage prevented retention of memory during a power interruption. Data in the event log area are invalid. 				○		page 3-158

Event code	Event name	Meaning	Assumed cause	Level					Reference
				M a j	P r t	M i n	O b s	I n f o	
10260000 hex	Trace Setting Transfer Failure	The power supply was interrupted while transferring the trace settings.	<ul style="list-style-type: none"> The power supply was interrupted while transferring the trace settings. 				○		page 3-158
10290000 hex (Ver. 1.03 or later)	Backup Failed to Start	An error was detected in pre-execution checks for a backup operation.	<ul style="list-style-type: none"> An SD Memory Card is not inserted. The SD Memory Card type is not correct. The format of the SD Memory Card is not correct. The SD Memory Card is write protected. The Prohibiting backing up data to the SD Memory Card parameter is set to prohibit backing up data to an SD Memory Card. Another backup operation is in progress. Synchronization, online editing, or the Clear All Memory operation is in progress. The backup was canceled by the user. The online connection with the Sysmac Studio was disconnected. The SD Memory Card is damaged. An unexpected error has occurred. 				○		page 3-159

Event code	Event name	Meaning	Assumed cause	Level					Reference
				M a j	P r t	M i n	O b s	I n f o	
102A0000 hex (Ver. 1.03 or later)	Backup Failed	The backup operation ended in an error.	<ul style="list-style-type: none"> The capacity of the SD Memory Card is insufficient. It was not possible to save the data that was specified for backup. The SD Memory Card was removed during a backup operation. Failed to back up Unit or slave. The backup was canceled by the user. Execution of the Save Cam Table instruction or changing the CPU Unit name is in progress. The online connection with the Sysmac Studio was disconnected. It was not possible to save the data that was specified for backup to the computer. The SD Memory Card is damaged. An unexpected error has occurred. <p>Also check the following when you use the Robot Integrated CPU Unit.</p> <ul style="list-style-type: none"> The SD Memory Card format is invalid The SD Memory Card is write protected. The /D folder, which is the data to be backed up, does not exist on the SD Memory Card. 					○	page 3-161

Event code	Event name	Meaning	Assumed cause	Level					Reference
				M a j	P r t	M i n	O b s	I n f o	
102B0000 hex (Ver. 1.03 or later)	Restore Operation Failed to Start	An error was detected in pre-execution checks for a restore operation.	<ul style="list-style-type: none"> An SD Memory Card is not inserted. The SD Memory Card type is not correct. The format of the SD Memory Card is not correct. There are no backup files on the SD Memory Card. Either the backup files on the SD Memory Card are corrupted or required data is not in the backup files on the SD Memory Card. The unit version of the CPU Unit to which to restore the files is older than the unit version of the backup files on the SD Memory Card. The model of the CPU Unit to which to restore the files is not the same as the model of the CPU Unit of the backup files on the SD Memory Card. Recovery was executed for the SD Memory Card. The CPU Unit is write-protected. The settings in the restore command file (RestoreCommand.ini) are not correct. A backup operation is in progress. Synchronization, online editing, or the Clear All Memory operation is in progress. The online connection with the Sysmac Studio was disconnected. Reading the data for restoration failed because the SD Memory Card is faulty or not formatted correctly. The SD Memory Card is damaged. The database connection service version of the CPU Unit to which to restore the files is older than the database connection service version of the backup files on the SD Memory Card. 						page 3-163

Event code	Event name	Meaning	Assumed cause	Level					Reference
				M a j	P r t	M i n	O b s	I n f o	
			<ul style="list-style-type: none"> The robot version of the CPU Unit to which to restore the files is older than the robot version of the backup files on the SD Memory Card. The CPU Unit failed to process the power OFF during the last power interruption. An unexpected error has occurred. <p>Check the followings for specification with system-defined variables.</p> <ul style="list-style-type: none"> Restore by system-defined variable is set to Do not use in the Controller Setup. Password of Restore by system-defined variable in the Controller Setup does not agree with the _Card1RestoreCmd.Password system-defined variable. The DIP switch on the CPU Unit is not set to allow starting the restore of SD Memory Card backups by specification with system-defined variables. There is no such folder as specified by the system-defined variable. Required files are not set to transfer in the setting of the system-defined variable. <p>Also check the following when you use the Robot Integrated CPU Unit.</p> <ul style="list-style-type: none"> The SD Memory Card is write protected. The capacity of the SD Memory Card is insufficient. 						

Event code	Event name	Meaning	Assumed cause	Level					Reference
				M a j	P r t	M i n	O b s	I n f o	
102C0000 hex (Ver. 1.03 or later)	Restore Op- eration Failed	The restore operation ended in an error.	<ul style="list-style-type: none"> It was not possible to read the data to restore. The SD Memory Card was removed during a restore operation. Failed to restore Unit or slave. The SD Memory Card is damaged. An unexpected error has occurred. <p>Also check the following when you use the Robot Integrated CPU Unit.</p> <ul style="list-style-type: none"> The SD Memory Card is write protected. The capacity of the SD Memory Card is insufficient. The number of files or directories in the SD Memory Card exceeded the maximum number supported by the file system of the SD Memory Card. 				○		page 3-166

Event code	Event name	Meaning	Assumed cause	Level					Reference
				M a j	P r t	M i n	O b s	I n f o	
10320000 hex (Ver. 1.11 or later)	SD Memory Card Program Transfer Failed to Start	An error was detected in pre-start checks for transferring SD Memory Card programs.	<ul style="list-style-type: none"> Program transfer by system-defined variable is set to Do not use in the Controller Setup. Password of Program transfer by system-defined variable in the Controller Setup does not agree with the <code>_Card1PrgTransferCmd.Password</code> system-defined variable. The DIP switch on the CPU Unit is not set to allow starting the SD Memory Card program transfer. An SD Memory Card is not inserted. The SD Memory Card type is not correct. The format of the SD Memory Card is not correct. There is no such folder on the SD Memory Card as specified by the <code>_Card1PrgTransferCmd.DirName</code> system-defined variable. There are no backup files in such a folder on the SD Memory Card as specified by the <code>_Card1PrgTransferCmd.DirName</code> system-defined variable. Either the backup files in the folder specified by the <code>_Card1PrgTransferCmd.DirName</code> system-defined variable on the SD Memory Card are corrupted or required data is not in the backup files on the SD Memory Card. The unit version of the CPU Unit to which to transfer the files is older than the unit version of the backup files on the SD Memory Card. The model of the CPU Unit to which to transfer the files is not the same as the model of the CPU Unit of the backup files on the SD Memory Card. The CPU Unit is write-protected. Another backup operation is in progress. 					○	page 3-168

Event code	Event name	Meaning	Assumed cause	Level					Reference
				M a j	P r t	M i n	O b s	I n f o	
			<ul style="list-style-type: none"> • Synchronization, online editing, or the Clear All Memory operation is in progress. • Required files are not set to transfer in the setting of the _Card1PrgTransferCmd system-defined variable. • Reading the data for the SD Memory Card program transfer failed because the SD Memory Card is faulty or not formatted correctly. • The SD Memory Card is damaged. • The CPU Unit failed to process the power OFF during the last power interruption. • An unexpected error has occurred. • The database connection service version of the CPU Unit to which to transfer the files is older than the database connection service version of the backup files on the SD Memory Card. • The robot version of the CPU Unit to which to transfer the files is older than the robot version of the backup files on the SD Memory Card. 						

Event code	Event name	Meaning	Assumed cause	Level					Reference
				M a j	P r t	M i n	O b s	I n f o	
103E0000 hex (Version 1.14 or later)	Restore Pre-execution Check Failure	An error was detected in preexecution checks for specification with system-defined variables for the SD Memory Card restore operation.	<ul style="list-style-type: none"> An SD Memory Card is not inserted. The SD Memory Card type is not correct. The format of the SD Memory Card is not correct. There is no such folder on the SD Memory Card as specified by the <code>_Card1RestoreCmd.DirName</code> system-defined variable. There are no backup files in such a folder on the SD Memory Card as specified by the <code>_Card1RestoreCmd.DirName</code> system-defined variable. Either the backup files in the folder specified by the <code>_Card1RestoreCmd.DirName</code> system-defined variable on the SD Memory Card are corrupted or required data is not in the backup files on the SD Memory Card. The unit version of the CPU Unit to which to transfer the files is older than the unit version of the backup files on the SD Memory Card. The model of the CPU Unit to which to transfer the files is not the same as the model of the CPU Unit of the backup files on the SD Memory Card. The CPU Unit is write-protected. Required files are not set to transfer in the setting of the system-defined variable. Reading the data for the SD Memory Card program transfer failed because the SD Memory Card is faulty or not formatted correctly. The SD Memory Card is damaged. The CPU Unit failed to process the power OFF during the last power interruption. An unexpected error has occurred. 						page 3-171

Event code	Event name	Meaning	Assumed cause	Level					Reference
				M a j	P r t	M i n	O b s	I n f o	
			<ul style="list-style-type: none"> The database connection service version of the CPU Unit to which to transfer the files is older than the database connection service version of the backup files on the SD Memory Card. The robot version of the CPU Unit to which to transfer the files is older than the robot version of the backup files on the SD Memory Card. 						
103F0000 hex	Online Edits Transfer Failure	Transferring the online edits failed.	<ul style="list-style-type: none"> The number of variables exceeded the upper limit of variables. The variable setting for Initial Value Specified/No Initial Value Specified was changed. 				○		page 3-173
152C0000Hex (Ver. 1.63 or later) [NX502]	Variable Log Save Failed	Variable logs were not saved.	<ul style="list-style-type: none"> Although the conditions for saving the variable log were satisfied, the variable log could not be generated due to the following factors. <ul style="list-style-type: none"> The storage to save the log is unavailable for some reason. The storage to save the log is write-protected. Number of files or directories in the storage has reached the maximum number. 			○	○		page 3-174
10630000 hex (Ver. 1.31 or later) [NX102] (Ver. 1.60 or later) [NX502]	Safety Data Logging Failed to Start	Starting the safety data logging failed.	<ul style="list-style-type: none"> An SD Memory Card is not inserted. There are no logging setting files. The logging settings number of the logging setting file is duplicated. The logging settings number of the logging setting file is outside of the specifications. The logging setting files are invalid. Not all of safety master connections are established. Impossible to access a logging target variable that is specified in the logging setting file. 				○		page 3-175

Event code	Event name	Meaning	Assumed cause	Level					Reference
				M a j	P r t	M i n	O b s	I n f o	
10640000 hex (Version 1.31 or later) [NX102] (Ver. 1.60 or later) [NX502]	Safety Data Log File Save Failed	Saving the log file for safety data logging failed.	<ul style="list-style-type: none"> The SD Memory Card was removed after the start of logging. The SD Memory Card is write-protected. The capacity of the SD Memory Card is insufficient. The maximum number of files for an SD Memory Card was exceeded. The SD Memory Card is damaged. 				○		page 3-176
40140000 hex	PLC System Information	This event provides internal information from the PLC Function Module.	<ul style="list-style-type: none"> This event provides internal information from the PLC Function Module. It is recorded to provide additional information for another event. 				○		page 3-177
40170000 hex (Ver. 1.03 or later)	Safe Mode	The Controller started in Safe Mode.	<ul style="list-style-type: none"> The Controller started in Safe Mode. 				○		page 3-177
64040000 hex (Ver. 1.68 or later) [NX502]	Upper Limit of Sampling Processing Capacity	Variable sampling was omitted because the sampling processing capacity exceeded the upper limit.	<ul style="list-style-type: none"> The sampling processing capacity exceeded the upper limit. 			⊙	○		page 3-178
64050000Hex (Ver. 1.63 or later) [NX502]	Capacity Warning of Variable Log Save Destination	The free storage space for variable logs is less than the specified capacity.	<ul style="list-style-type: none"> The free storage space for variable logs has fallen below the specified capacity. 			⊙	○		page 3-178
64060000Hex (Ver. 1.63 or later) [NX502]	No Variable Log Concurrency	The task of the next task period started before variable sampling was completed. If the variable log is output in this status, the concurrency of the variable log data cannot be ensured.	<ul style="list-style-type: none"> Due to the following factors, the task of the next task period started before the variable sampling was completed. <ul style="list-style-type: none"> The number of variables to be sampled is too large. Task execution time as a ratio of overall task period is too high. 			⊙	○		page 3-179
64070000Hex (Ver. 1.63 or later) [NX502]	Cycle with No Variable Sampling	A cycle occurred in which variable sampling was omitted.	<ul style="list-style-type: none"> Due to the following factors, a period in which variable sampling is not performed occurred. <ul style="list-style-type: none"> The number of variables to be sampled is too large. Unused time in task period is too short. 			⊙	○		page 3-180

Event code	Event name	Meaning	Assumed cause	Level					Reference
				M a j	P r t	M i n	O b s	I n f o	
64080000 hex (Ver. 1.69 or later) [NJ-series, NX502, NX102, and NX1P2] (Ver. 1.36 or later) [NX701]	Secure Communica- tion Forced Start	Secure communica- tion was forced to start.	<ul style="list-style-type: none"> The CPU Unit has started with the secure communications version set to 2 and the DIP switch <i>set to allow connection from the Sysmac Studio or an NA-series Programmable Terminal that does not support secure communication.</i> 				○		page 3-181
80230000 hex (Ver. 1.05 or later)	NX Message Communica- tions Error	An error has occurred in message commu- nications.	<ul style="list-style-type: none"> The communications cable is broken. The communications cable connector is disconnected. The NX message communica- tions load is high. 				○		page 3-182
90470000 hex (Version 1.31 or later) [NX102] (Ver. 1.60 or later) [NX502]	Safety Data Logging Aborted	The execution of safety data logging was aborted.	<ul style="list-style-type: none"> The execution of safety data logging was aborted by a service switch operation. Either a communication error on the safety master connections occurred or the Safety CPU Unit entered a operating mode where it could not continue safety process data communications. The NX bus was restarted. The Controller Setup or program was changed. 				○		page 3-183
95760000Hex (Ver. 1.63 or later) [NX502]	Variable Log Overwritten	Old variable logs were cleared and new variable logs were saved.	<ul style="list-style-type: none"> There is not enough free space in the storage, or it has fallen below the specified capacity. 			○	○		page 3-184
957A0000 hex (Ver. 1.68 or later) [NX502]	Variable Log Save Not Possible	The variable log save conditions were met when the variable log could not be record- ed.	<ul style="list-style-type: none"> The variable log save conditions were met when the variable log could not be recorded. 				○		page 3-184
40150000 hex	PLC System Information	This event provides internal information from the PLC Func- tion Module.	<ul style="list-style-type: none"> This event provides internal information from the PLC Function Module. It is recorded to provide additional information for another event. 					○	page 3-185
44430000 hex (Ver. 1.05 or later)	PLC System Information	This event provides internal information from the PLC Func- tion Module.	<ul style="list-style-type: none"> This event provides internal information from the PLC Function Module. It is recorded to provide additional information for another event. 					○	page 3-185
90010000 hex	Clock Changed	The clock time was changed.	<ul style="list-style-type: none"> The clock time was changed. 					○	page 3-186
90020000 hex	Time Zone Changed	The time zone was changed.	<ul style="list-style-type: none"> The time zone was changed. 					○	page 3-186

Event code	Event name	Meaning	Assumed cause	Level					Reference
				M a j	P r t	M i n	O b s	I n f o	
90030000 hex (Ver. 1.49 or later) [NJ-series, NX102, NX1P2] (Ver. 1.60 or later) [NX502] (Ver. 1.29 or later) [NX701]	Online Con- nection Started	Online connection with the Sysmac Stu- dio was started.	<ul style="list-style-type: none"> Online connection with the Sysmac Studio was started. 					○	page 3-187
90040000 hex (Version 1.49 or later) [NJ-series, NX102, NX1P2] (Ver. 1.60 or later) [NX502] (Ver. 1.29 or later) [NX701]	Online Con- nection Ended	Online connection with the Sysmac Stu- dio was terminated.	<ul style="list-style-type: none"> Online connection with the Sysmac Studio was terminated. 					○	page 3-188
90050000 hex (Ver. 1.10 or later)	User Pro- gram/ Controller Configura- tions and Setup Down- loaded	The user program and the Controller configurations and setup were down- loaded.	<ul style="list-style-type: none"> The user program and the Controller configurations and setup were downloaded. 					○	page 3-189
90070000 hex (Ver. 1.10 or later)	Online Edits Transferred	The user program was edited online.	<ul style="list-style-type: none"> The user program was edited online and the edits were transferred to the Controller. 					○	page 3-190
90080000 hex	Variable Changed to TRUE with Forced Re- freshing	Changing a variable to TRUE with forced refreshing was speci- fied.	<ul style="list-style-type: none"> Changing a variable to TRUE with forced refreshing was specified by the user. 					○	page 3-190
90090000 hex	Variable Changed to FALSE with Forced Re- freshing	Changing a variable to FALSE with forced refreshing was speci- fied.	<ul style="list-style-type: none"> Changing a variable to FALSE with forced refreshing was specified by the user. 					○	page 3-191
900A0000 hex	All Forced Refreshing Cleared	Clearing all forced re- freshing values was specified.	<ul style="list-style-type: none"> Clearing all forced refreshing values was specified by the user. 					○	page 3-191
900B0000 hex	Memory All Cleared	All memory was cleared.	<ul style="list-style-type: none"> A user with Administrator rights cleared all of the memory. 					○	page 3-192
900C0000 hex	Event Log Cleared	The event log was cleared.	<ul style="list-style-type: none"> The event log was cleared by the user. 					○	page 3-193
900F0000 hex (Ver. 1.03 or later)	Automatic Transfer Completed	The automatic trans- fer was completed.	<ul style="list-style-type: none"> The automatic transfer was completed. 					○	page 3-193

Event code	Event name	Meaning	Assumed cause	Level					Reference
				M a j	P r t	M i n	O b s	I n f o	
90110000 hex	Power Turned ON	The power supply was turned ON.	• The power supply was turned ON.					○	page 3-194
90120000 hex	Power Interrupted	The power supply was interrupted.	• The power supply was interrupted.					○	page 3-194
90130000 hex	Operation Started	Operation was started.	• A command to start operation was received.					○	page 3-194
90140000 hex	Operation Stopped	Operation was stopped.	• A command to stop operation was received.					○	page 3-195
90150000 hex	Reset Executed	A reset was executed.	• A reset command was received.					○	page 3-195
90160000 hex	User Program Execution ID Write	The user program execution ID was set or changed in the CPU Unit.	• A user with Administrator rights changed the user program execution ID that is set in the CPU Unit.					○	page 3-196
90170000 hex (Version 1.49 or later) [NJ-series, NX102, NX1P2] (Ver. 1.60 or later) [NX502] (Ver. 1.29 or later) [NX701]	Authentication Setting Transferred	The authentication setting was transferred.	• The authentication setting was transferred.					○	page 3-197
90180000 hex	All Controller Errors Cleared	All current errors were cleared.	• The user cleared all current errors.					○	page 3-197
90190000 hex	Forced Refreshing Cleared	Clearing a forced refreshing value was specified.	• Clearing a forced refreshing value was specified by the user.					○	page 3-198
901A0000 hex (Ver. 1.03 or later)	Backup Started	A backup operation was started.	• A backup operation was started.					○	page 3-198
901B0000 hex (Ver. 1.03 or later)	Backup Completed	The backup operation ended normally.	• The backup operation ended normally.					○	page 3-199
901C0000 hex (Ver. 1.03 or later)	Restore Operation Started	A restore operation started.	• A restore operation started.					○	page 3-199
901D0000 hex (Ver. 1.03 or later)	Restore Operation Completed	The restore operation ended normally.	• The restore operation ended normally.					○	page 3-200
90200000 hex (Ver. 1.11 or later)	SD Memory Card Program Transfer Started	Transferring the SD Memory Card programs was started.	• Transferring the SD Memory Card programs was started.					○	page 3-200
90210000 hex (Ver. 1.11 or later)	SD Memory Card Program Transfer Completed	Transferring the SD Memory Card programs was completed.	• Transferring the SD Memory Card programs was completed.					○	page 3-201

Event code	Event name	Meaning	Assumed cause	Level					Reference
				M a j	P r t	M i n	O b s	I n f o	
90290000 hex (Ver. 1.32 or later) [NX102] (Ver. 1.21 or later) [NX701-□□00, NX1P2, NJ501 (excluding NJ501-□□20), NJ301, NJ101-□□00]	Project Unit Version Changed	The project unit ver- sion was changed.	<ul style="list-style-type: none"> The project unit version of the project in the Controller in the transfer or restore destination and that in the transfer or restore source project are different. The project was transferred or restored in the default or Clear All Memory state. 					○	page 3-201
902A0000 hex (Version 1.49 or later) [NJ-series, NX102, NX1P2] (Ver. 1.60 or later) [NX502] (Ver. 1.29 or later) [NX701]	Change to RUN Mode Commanded	The Controller re- ceived a command to switch to RUN mode.	<ul style="list-style-type: none"> The Controller received a command to switch to RUN mode. 					○	page 3-202
902B0000 hex (Version 1.49 or later) [NJ-series, NX102, NX1P2] (Ver. 1.60 or later) [NX502] (Ver. 1.29 or later) [NX701]	Change to PROGRAM Mode Com- manded	The Controller re- ceived a command to switch to PROGRAM mode.	<ul style="list-style-type: none"> The Controller received a command to switch to PROGRAM mode. 					○	page 3-202
902C0000 hex (Version 1.49 or later) [NJ-series, NX102, NX1P2] (Ver. 1.60 or later) [NX502] (Ver. 1.29 or later) [NX701]	Access Rights Forci- bly Released	The access rights were forcibly re- leased.	<ul style="list-style-type: none"> The access rights were forcibly released. 					○	page 3-203
902D0000 hex (Version 1.49 or later) [NJ-series, NX102, NX1P2] (Ver. 1.60 or later) [NX502] (Ver. 1.29 or later) [NX701]	CPU Unit Name Changed	The CPU Unit name was changed.	<ul style="list-style-type: none"> The CPU Unit name was changed. 					○	page 3-203

Event code	Event name	Meaning	Assumed cause	Level					Reference
				M a j	P r t	M i n	O b s	I n f o	
902E0000 hex (Version 1.49 or later) [NJ-series, NX102, NX1P2] (Ver. 1.60 or later) [NX502] (Ver. 1.29 or later) [NX701]	CPU Unit Write Protected	The CPU Unit was write-protected.	<ul style="list-style-type: none"> The CPU Unit was write-protected. 					○	page 3-204
902F0000 hex (Version 1.49 or later) [NJ-series, NX102, and NX1P2] (Ver. 1.60 or later) [NX502] (Ver. 1.29 or later) [NX701]	Operation Mode Change Setting Written	Setting to change the operation mode was written.	<ul style="list-style-type: none"> Setting to change the operation mode was written. 					○	page 3-204
90300000 hex (Version 1.49 or later) [NJ-series, NX102, NX1P2] (Ver. 1.60 or later) [NX502] (Ver. 1.29 or later) [NX701]	Backup Start Commanded	The Controller received a command to start backup operation from Sysmac Studio.	<ul style="list-style-type: none"> The Controller received a command to start backup operation from Sysmac Studio. 					○	page 3-205
90310000 hex (Version 1.49 or later) [NJ-series, NX102, NX1P2] (Ver. 1.60 or later) [NX502] (Ver. 1.29 or later) [NX701]	Restore Start Commanded	The Controller received a command to start restore operation from Sysmac Studio.	<ul style="list-style-type: none"> The Controller received a command to start restore operation from Sysmac Studio. 					○	page 3-205
90320000 hex (Version 1.60 or later) [NJ-series, NX102, NX1P2] (Version 1.32 or later) [NX701]	Firmware Update Prohibition Setting Changed	Firmware update prohibition setting was changed.	<ul style="list-style-type: none"> Firmware update prohibition setting was changed. 					○	page 3-206

Event code	Event name	Meaning	Assumed cause	Level					Reference
				M a j	P r t	M i n	O b s	I n f o	
90330000 hex (Version 1.49 or later) [NJ-series, NX102, NX1P2] (Ver. 1.60 or later) [NX502] (Ver. 1.29 or later) [NX701]	Start Instruction of Omron Maintenance	Maintenance by Omron maintenance personnel was begun.	<ul style="list-style-type: none"> Maintenance by Omron maintenance personnel was begun. 					○	page 3-206
90340000 hex (Version 1.49 or later) [NJ-series, NX102, NX1P2] (Ver. 1.60 or later) [NX502] (Ver. 1.29 or later) [NX701]	End Instruction of Omron Maintenance	Maintenance by Omron maintenance personnel was ended.	<ul style="list-style-type: none"> Maintenance by Omron maintenance personnel was ended. 					○	page 3-207
90460000 hex (Version 1.31 or later) [NX102] (Ver. 1.60 or later) [NX502]	Safety Data Logging Started	Safety data logging was started.	Safety data logging was started because the start conditions were met.					○	page 3-207
90480000 hex (Version 1.31 or later) [NX102] (Ver. 1.60 or later) [NX502]	Safety Data Logging Completed	The execution of safety data logging was completed because the trigger conditions were met.	The trigger condition that is specified in the Safety Data Logging Settings is met, and safety data logging ends.					○	page 3-208
90A20000 hex (Version 1.49 or later) [NJ-series, NX102, NX1P2] (Ver. 1.60 or later) [NX502] (Ver. 1.29 or later) [NX701]	User Authentication Enabled	User authentication was enabled.	User authentication was enabled.					○	page 3-208
90A30000 hex (Version 1.49 or later) [NJ-series, NX102, NX1P2] (Ver. 1.60 or later) [NX502] (Ver. 1.29 or later) [NX701]	User Authentication Disabled	User authentication was disabled.	User authentication was disabled.					○	page 3-209

Event code	Event name	Meaning	Assumed cause	Level					Reference
				M a j	P r t	M i n	O b s	I n f o	
90A40000 hex (Version 1.49 or later) [NJ-series, NX102, NX1P2] (Ver. 1.60 or later) [NX502] (Ver. 1.29 or later) [NX701]	User Added	A user was added.	A user was added.					○	page 3-210
90A50000 hex (Version 1.49 or later) [NJ-series, NX102, NX1P2] (Ver. 1.60 or later) [NX502] (Ver. 1.29 or later) [NX701]	User Deleted	A user was deleted.	A user was deleted.					○	page 3-211
90A60000 hex (Version 1.49 or later) [NJ-series, NX102, NX1P2] (Ver. 1.60 or later) [NX502] (Ver. 1.29 or later) [NX701]	User Authority Changed	A user authority was changed.	A user authority was changed.					○	page 3-212
90A70000 hex (Version 1.49 or later) [NJ-series, NX102, NX1P2] (Ver. 1.60 or later) [NX502] (Ver. 1.29 or later) [NX701]	User Password Changed	A user password was changed.	A user password was changed.					○	page 3-213
90A80000 hex (Version 1.49 or later) [NJ-series, NX102, NX1P2] (Ver. 1.60 or later) [NX502] (Ver. 1.29 or later) [NX701]	User Password Validity Period Control Enabled	Control of user password validity period was activated.	Control of user password validity period was activated.					○	page 3-213

Event code	Event name	Meaning	Assumed cause	Level					Reference
				M a j	P r t	M i n	O b s	I n f o	
90A90000 hex (Version 1.49 or later) [NJ-series, NX102, NX1P2] (Ver. 1.60 or later) [NX502] (Ver. 1.29 or later) [NX701]	User Password Validity Period Control Disabled	Control of user password validity period was disabled.	Control of user password validity period was disabled.					○	page 3-214
90AA0000 hex (Version 1.49 or later) [NJ-series, NX102, NX1P2] (Ver. 1.60 or later) [NX502] (Ver. 1.29 or later) [NX701]	User Password Validity Period Changed	A validity period of user password was changed.	A validity period of user password was changed.					○	page 3-214
90AB0000 hex (Version 1.49 or later) [NJ-series, NX102, NX1P2] (Ver. 1.60 or later) [NX502] (Ver. 1.29 or later) [NX701]	User Authentication Operation Lock Enabled	Operation lock of user authentication function was enabled.	Operation lock of user authentication function was enabled.					○	page 3-215
90AC0000 hex (Version 1.49 or later) [NJ-series, NX102, NX1P2] (Ver. 1.60 or later) [NX502] (Ver. 1.29 or later) [NX701]	User Authentication Operation Lock Disabled	Operation lock of user authentication function was disabled.	Operation lock of user authentication function was disabled.					○	page 3-215
90AD0000 hex (Version 1.49 or later) [NJ-series, NX102, NX1P2] (Ver. 1.60 or later) [NX502] (Ver. 1.29 or later) [NX701]	User Authentication Operation Lock Time Changed	Operation lock time of user authentication function was changed.	Operation lock time of user authentication function was changed.					○	page 3-216

Event code	Event name	Meaning	Assumed cause	Level					Reference
				M a j	P r t	M i n	O b s	I n f o	
90AE0000 hex (Version 1.49 or later) [NJ-series, NX102, NX1P2] (Ver. 1.60 or later) [NX502] (Ver. 1.29 or later) [NX701]	Operation Authority Verification Enabled	Operation authority verification was enabled.	Operation authority verification was enabled.					○	page 3-217
90AF0000 hex (Version 1.49 or later) [NJ-series, NX102, NX1P2] (Ver. 1.60 or later) [NX502] (Ver. 1.29 or later) [NX701]	Operation Authority Verification Disabled	Operation authority verification was disabled.	Operation authority verification was disabled.					○	page 3-218
90B00000 hex (Version 1.49 or later) [NJ-series, NX102, NX1P2] (Ver. 1.60 or later) [NX502] (Ver. 1.29 or later) [NX701]	Operation Authority Password Changed	A operation authority password was changed.	A operation authority password was changed.					○	page 3-219
90B10000 hex (Version 1.49 or later) [NJ-series, NX102, NX1P2] (Ver. 1.60 or later) [NX502] (Ver. 1.29 or later) [NX701]	Operation Authority for Password Input Omission Changed	An operation authority used when password input is omitted was changed.	An operation authority used when password input is omitted was changed.					○	page 3-220
90B20000 hex (Version 1.49 or later) [NJ-series, NX102, NX1P2] (Ver. 1.60 or later) [NX502] (Ver. 1.29 or later) [NX701]	Operation Authority Verification Operation Lock Enabled	Operation lock of operation authority verification function was enabled.	Operation lock of operation authority verification function was enabled.					○	page 3-221

Event code	Event name	Meaning	Assumed cause	Level					Reference
				M a j	P r t	M i n	O b s	I n f o	
90B30000 hex (Version 1.49 or later) [NJ-series, NX102, NX1P2] (Ver. 1.60 or later) [NX502] (Ver. 1.29 or later) [NX701]	Operation Authority Verification Operation Lock Disabled	Operation lock of operation authority verification function was disabled.	Operation lock of operation authority verification function was disabled.					○	page 3-222
90B40000 hex (Version 1.49 or later) [NJ-series, NX102, NX1P2] (Ver. 1.60 or later) [NX502] (Ver. 1.29 or later) [NX701]	Operation Authority Verification Operation Lock Time Changed	Operation lock time of operation authority verification function was changed.	Operation lock time of operation authority verification function was changed.					○	page 3-223
90B50000 hex (Version 1.49 or later) [NJ-series, NX102, NX1P2] (Ver. 1.60 or later) [NX502] (Ver. 1.29 or later) [NX701]	User Password Expiration Notice Enabled	User password expiration notice was enabled.	<ul style="list-style-type: none"> User password expiration notice was enabled. 					○	page 3-223
90B60000 hex (Version 1.49 or later) [NJ-series, NX102, NX1P2] (Ver. 1.60 or later) [NX502] (Ver. 1.29 or later) [NX701]	User Password Expiration Notice Disabled	User password expiration notice was disabled.	<ul style="list-style-type: none"> User password expiration notice was disabled. 					○	page 3-224
90B70000 hex (Version 1.49 or later) [NJ-series, NX102, NX1P2] (Ver. 1.60 or later) [NX502] (Ver. 1.29 or later) [NX701]	Days for Prior Notice of User Password Expiration Changed	Number of days set to give prior notice of user password expiration was changed.	<ul style="list-style-type: none"> Number of days set to give prior notice of user password expiration was changed. 					○	page 3-224

Event code	Event name	Meaning	Assumed cause	Level					Reference
				M a j	P r t	M i n	O b s	I n f o	
90B80000 hex (Ver. 1.69 or later) [NJ-series, NX502, NX102, and NX1P2] (Ver. 1.36 or later) [NX701]	Secure Communica- tions Version Changed	The secure communi- cations version was changed.	<ul style="list-style-type: none"> The secure communications version was changed. 					○	page 3-225
95720000Hex (Ver. 1.63 or later) [NX502]	Automation Playback Settings Changed	The settings for the automation playback function were changed.	<ul style="list-style-type: none"> The Controller is synchronized with a project with changed settings on Sysmac Studio. 					○	page 3-225
95730000Hex (Ver. 1.63 or later) [NX502]	Variable Sampling Started	Variable sampling started.	<ul style="list-style-type: none"> Conditions to start variable sampling are met. 					○	page 3-226
95740000Hex (Ver. 1.63 or later) [NX502]	Variable Sampling Stopped	Variable sampling stopped.	<ul style="list-style-type: none"> Conditions to end variable sampling are met. 					○	page 3-226
95750000Hex (Ver.1.63 or later earlier than Ver.1.65) [NX502]	Variable Log Output Com- pleted	Variable log output has completed.	<ul style="list-style-type: none"> Save conditions of variable log are satisfied and output is completed. 					○	page 3-227
95780000 hex (Ver.1.65 or later) [NX502]	Variable Log Output Com- pleted	Variable log output has completed.	<ul style="list-style-type: none"> Save conditions of variable log are satisfied and output is completed. 					○	page 3-227

Errors Related to FINS Communications

Event code	Event name	Meaning	Assumed cause	Level					Reference
				M a j	P r t	M i n	O b s	I n f o	
14010000 hex [NJ-series]	CPU Bus Unit Setup Area Error	An error was detected in the memory check of the Setup Area for CPU Bus Units.	<ul style="list-style-type: none"> The power supply to the Controller was interrupted or communications with the Sysmac Studio were disconnected while downloading the CPU Bus Unit Settings. 				○		page 3-228
34100000 hex [NJ-series, NX701-□ □20, NX502, NX102, NX1P2]	IP Address Table Setting Error	The IP address table settings are incorrect.	<ul style="list-style-type: none"> The IP address conversion method is set to the combined method or the IP address table method, but the IP address table settings are incorrect. 				○		page 3-228
34130000 hex [NJ-series, NX701-□ □20, NX502, NX102]	FINS/TCP Connection Table Setting Error	The FINS/TCP connection table is incorrect.	<ul style="list-style-type: none"> The power supply to the Controller was interrupted or communications with the Sysmac Studio were disconnected while downloading the FINS/TCP connection table. 				○		page 3-229
34110000 hex [NJ-series, NX701-□ □20, NX502, NX102, NX1P2]	Unknown Destination Node	The send destination node is not known.	<ul style="list-style-type: none"> The send destination node was not found when a FINS message was sent. 				○		page 3-229
80100000 hex [NJ-series, NX701-□ □20, NX502, NX102, NX1P2]	Packet Dis- carded	One or more packets were discarded.	<ul style="list-style-type: none"> A FINS response addressed to the CPU Unit was received. The send designation Unit for the FINS response does not exist. 				○		page 3-230
80110000 hex [NJ-series]	Packet Dis- carded	One or more packets were discarded.	<ul style="list-style-type: none"> An attempt was made to send a FINS response with over 2002 bytes. An attempt was made to route a FINS response with over 2002 bytes. Packet was received with a No Such Unit routing error. Packet was received with a Routing Error routing error. Packet was received with a No Routing Table routing error. Packet was received with an Event Area Size Over Limit routing error. There is insufficient space in the internal buffer. FINS message routing failed because the communications load is too high. 				○		page 3-231

Event code	Event name	Meaning	Assumed cause	Level					Reference
				M a j	P r t	M i n	O b s	I n f o	
80120000 hex [NJ-series, NX701-□ □20, NX502, NX102, NX1P2]	Packet Dis- carded	One or more packets were discarded.	<ul style="list-style-type: none"> • A FINS response was received with the destination network address (DNA) set to the local network and the destination node address (DA1) not set to the local node. • A FINS command or response was received with a hub network address specification for which the destination network address (DNA) was greater than or equal to 80 hex. • There is insufficient space in the internal buffer. • A FINS command that does not have the minimum command length was received. • A FINS command that exceeded the maximum command length was received. • Sending packets failed. • FINS message routing failed because the communications load is too high. Or a command that was addressed to the built-in EtherNet/IP port was received with the source network address (SNA) set to 0. • A FINS response that was addressed to the built-in EtherNet/IP port was received. • A FINS response or a command for which a response is not required was received when the routing tables were not registered. • A FINS response or a command for which a response is not required was received when there was an error in the routing tables. • A FINS response or a command for which a response is not required was received that exceeded the number of relay points. • Transmission is not possible because the destination address is not set in the routing tables. 						page 3-232

Event code	Event name	Meaning	Assumed cause	Level					Reference
				M a j	P r t	M i n	O b s	I n f o	
			<ul style="list-style-type: none"> Routing is not possible because the FINS node address setting in the Built-in EtherNet/IP Port Settings is set to 0 or 255. 						

Instructions

This section provides a table of errors (events) that occur for instructions. The lower four digits of the event code represent the error code (ErrorID) for the instruction. For descriptions of an error code, refer to the description of the corresponding event code. For example, if the error code of the instruction is 16#0400, refer to the description of event code 54010400 hex.

Event codes for instructions are supported by CPU Units with unit version 1.02 or later.

Event code	Event name	Meaning	Assumed cause	Level					Reference
				M a j	P r t	M i n	O b s	I n f o	
54010415 hex	Firmware Error	An error was detected when an instruction was executed.	<ul style="list-style-type: none"> An error occurred in the software. 		○				page 3-234
54010400 hex	Input Value Out of Range	An input parameter for an instruction exceeded the valid range for an input variable. Or, division by an integer of 0 occurred in division or remainder calculations.	<ul style="list-style-type: none"> An input parameter for an instruction exceeded the valid range for an input variable. Or, division by an integer of 0 occurred in division or remainder calculations. 				○		page 3-235
54010401 hex	Input Mismatch	The relationship for the instruction input parameters did not meet required conditions. Or, a numeric value during or after instruction execution did not meet conditions.	<ul style="list-style-type: none"> The relationship for an input parameter did not meet required conditions. A value when processing an instruction or in the result does not meet the conditions. 				○		page 3-236
54010402 hex	Floating-point Error	Non-numeric data was input for a floating-point number input parameter to an instruction.	<ul style="list-style-type: none"> Non-numeric data was input for a floating-point number input parameter to an instruction. 				○		page 3-237
54010403 hex	BCD Error	A value that was not BCD was input for a BCD input parameter to an instruction.	<ul style="list-style-type: none"> A hexadecimal digit of A, B, C, D, E, or F was input for a BCD input parameter to an instruction. 				○		page 3-237

Event code	Event name	Meaning	Assumed cause	Level					Reference
				M a j	P r t	M i n	O b s	I n f o	
54010404 hex	Signed BCD Error	An illegal value was input for the most significant digit for a signed BCD input parameter to an instruction.	<ul style="list-style-type: none"> An illegal value was input for the most significant digit for a signed BCD input parameter to an instruction. The most-significant digit was 2 to F when <code>_BCD0</code> was specified as the BCD format. The most-significant digit was A, B, C, D, or E when <code>_BCD2</code> was specified as the BCD format. The most-significant digit was B, C, D, or E when <code>_BCD3</code> was specified as the BCD format. 				○		page 3-238
54010405 hex	Illegal Bit Position Specified	The bit position specified for an instruction was illegal.	<ul style="list-style-type: none"> The bit position specified for an instruction exceeds the data range. 				○		page 3-239
54010406 hex	Illegal Data Position Specified	A memory address or data size that was specified for the instruction is not suitable.	<ul style="list-style-type: none"> A memory address that was specified for an instruction was outside the valid range. The data size that was specified for an instruction exceeded the valid range. For example, the data type of a variable and the data size may not agree. 				○		page 3-239
54010407 hex	Data Range Exceeded	The results of instruction processing exceeded the data area range of the output parameter.	<ul style="list-style-type: none"> The results of instruction processing, such as the number of array elements, exceeded the data area range of the output parameter. 				○		page 3-240
54010409 hex	No Errors to Clear	An instruction to clear a Controller error was executed when there was no error in the Controller.	<ul style="list-style-type: none"> An instruction to clear a Controller error was executed when there was no error in the Controller. 				○		page 3-240
5401040B hex	No User Errors to Clear	An instruction to clear user-defined errors was executed when there was no user-defined error.	<ul style="list-style-type: none"> An instruction to clear user-defined errors was executed when there was no user-defined error. 				○		page 3-241
5401040C hex	Limit Exceeded for User-defined Errors	An attempt was made to use the Create User-defined Error instruction to create more than the maximum number of user-defined errors.	<ul style="list-style-type: none"> An attempt was made to use the Create User-defined Error instruction to create more than the maximum number of user-defined errors. 				○		page 3-241

Event code	Event name	Meaning	Assumed cause	Level					Reference
				M a j	P r t	M i n	O b s	I n f o	
5401040D hex [NJ-series]	Illegal Unit Specified	The Unit specified for an instruction does not exist.	<ul style="list-style-type: none"> A Unit that does not exist in the Unit configuration information was specified. A Unit that is in the Unit configuration information was specified, but the Units does not actually exist in the Controller. 				○		page 3-242
5401040F hex [NJ-series]	Unit Restart Failed	Restarting a Special I/O Unit or CPU Bus Unit failed.	<ul style="list-style-type: none"> The Special Unit is operating. 				○		page 3-242
54010410 hex	Text String Format Error	The text string input to an instruction is not correct.	<ul style="list-style-type: none"> The text string that is input to the instruction for conversion to a number does not represent a number or it does not represent a positive number. The input text string does not end in NULL. 				○		page 3-243
54010411 hex	Illegal Program Specified	The program specified for an instruction does not exist.	<ul style="list-style-type: none"> The program specified by the function does not exist (e.g., it was deleted). 				○		page 3-244
54010413 hex [NJ-series]	Undefined CJ-series Memory Address	The required specification is missing for a variable for which CJ-series Unit memory must be specified.	<ul style="list-style-type: none"> The required AT specification is missing for a variable for which CJ-series Unit memory must be specified. 				○		page 3-244
54010414 hex	Stack Underflow	There is no data in a stack.	<ul style="list-style-type: none"> An attempt was made to read data from a stack that contains no data. 				○		page 3-245
54010416 hex	Illegal Number of Array Elements or Dimensions	The valid range was exceeded for the number of array elements or dimensions in an array I/O parameter for an instruction.	<ul style="list-style-type: none"> The valid range was exceeded for the number of array elements or dimensions in an array I/O parameter for an instruction. 				○		page 3-245
54010417 hex	Specified Task Does Not Exist	The task specified for the instruction does not exist.	<ul style="list-style-type: none"> The specified task does not exist. 				○		page 3-246
54010418 hex	Unallowed Task Specification	An unallowed task was specified for an instruction.	<ul style="list-style-type: none"> The local task, the primary periodic task, or a periodic task was specified. 				○		page 3-246
54010419 hex	Incorrect Data Type	A data type that cannot be used for an instruction is specified for an input or in-out variable.	<ul style="list-style-type: none"> A data type that cannot be used for an instruction is specified for an input or in-out variable. 				○		page 3-247
5401041A hex	Multi-execution of Instructions	Multi-execution was specified for an instruction that does not support it.	<ul style="list-style-type: none"> Execution of an instruction that does not support multi-execution of instructions was specified more than once. 				○		page 3-247

Event code	Event name	Meaning	Assumed cause	Level					Reference
				M a j	P r t	M i n	O b s	I n f o	
5401041B hex (Ver. 1.02 or later)	Data Capacity Exceeded	Processing was not possible because the data that was passed to the instruction was too large.	<ul style="list-style-type: none"> Data that exceeded the size that can be processed was passed to an instruction. 				○		page 3-248
5401041C hex (Version 1.04 or later)	Different Data Sizes	The size of the data specified for instruction input or in-out data is different from the size of the target parameter.	<ul style="list-style-type: none"> Data of a size that is different from the size of the target parameter was specified for the input or in-out data of an instruction. 				○		page 3-249
5401041D hex (Ver. 1.05 or later)	Exceeded Simultaneous Instruction Executed Resources	The maximum resources that you can use for the relevant instruction group at the same time was exceeded.	<ul style="list-style-type: none"> More than the maximum number of relevant instructions were executed at the same time. 				○		page 3-250
54010421 hex (Ver. 1.50 or later) [NJ-series, NX102, and NX1P2] (Ver.1.32 or later) [NX701]	Failed to Get The Program Hash Code	Retrieving program hash code failed.	<ul style="list-style-type: none"> The transfer of the user program failed. The project downloaded to the CPU Unit does not contain the information required for the instruction. Non-volatile memory failure 				○		page 3-251
54010800 hex [NJ series, NX102, NX502]	FINS Error	An error occurred when a FINS command was sent or received.	<ul style="list-style-type: none"> An error occurred when a FINS command was sent or received. 				○		page 3-252
54010801 hex [NJ series, NX102, NX502]	FINS Port Already in Use	The FINS port is being used.	<ul style="list-style-type: none"> The FINS port is being used. 				○		page 3-252
54010C00 hex [NJ-series]	Illegal Serial Communications Mode	The Serial Communications Unit is not in the serial communications mode required to execute an instruction.	<ul style="list-style-type: none"> The serial communications port for the Serial Communications Unit is not set to the mode expected by the instruction. 				○		page 3-253
54010C03 hex (Ver. 1.11 or later)	Full Reception Buffer	The reception buffer is full.	<ul style="list-style-type: none"> The reception buffer is full. 				○		page 3-254
54010C04 hex (Ver. 1.11 or later)	Multi-execution of Ports	The serial communications instructions that cannot be executed simultaneously were executed.	<ul style="list-style-type: none"> An instruction was executed while another instruction that cannot be executed at the same time with the former instruction was executed. 				○		page 3-255
54010C05 hex (Ver. 1.11 or later)	Parity Error	A parity error occurred in the data received.	<ul style="list-style-type: none"> The communications settings or baud rate settings are not compatible with the remote device. Noise 				○		page 3-256

Event code	Event name	Meaning	Assumed cause	Level					Reference
				M a j	P r t	M i n	O b s	I n f o	
54010C06 hex (Ver. 1.11 or later)	Framing Error	A framing error occurred in the data received.	<ul style="list-style-type: none"> The communications settings or baud rate settings are not compatible with the remote device. Noise 				○		page 3-256
54010C07 hex (Ver. 1.11 or later)	Overrun Error	An overrun error occurred in the data received.	<ul style="list-style-type: none"> The next data was received during processing of received data because the baud rate is too high. 				○		page 3-257
54010C08 hex (Ver. 1.11 or later)	CRC Mismatch	The receive data had different CRC.	<ul style="list-style-type: none"> A wrong message was received. Noise 				○		page 3-258
54010C0B hex (Ver. 1.11 or later)	Serial Communications Timeout	A timeout occurred in serial communications.	<ul style="list-style-type: none"> Wiring to the remote device is not connected. Power to the remote device is OFF. The communications settings or baud rate settings are not compatible with the remote device. Noise 				○		page 3-259
54010C0C hex (Ver. 1.11 or later)	Instruction Executed to Inapplicable Port	An instruction was executed to an inapplicable port.	<ul style="list-style-type: none"> An instruction was executed to an inapplicable port. 				○		page 3-260
54010C0D hex (Ver. 1.13 or later)	CIF Unit Initialized	A CIF Unit was initialized, so the communications data buffered in the CIF Unit was lost.	A CIF Unit was initialized.				○		page 3-260
54010C10 hex (Ver. 1.11 or later)	Exceptional Modbus Response	An exceptional code was returned from the Modbus slave.	<ul style="list-style-type: none"> An error was detected on the Modbus slave. 				○		page 3-261
54010C11 hex (Ver. 1.11 or later)	Invalid Modbus Response	An unexpected response was returned from the Modbus slave.	<ul style="list-style-type: none"> The function code or data size of the response received from the Modbus slave was incorrect. 				○		page 3-262
54011400 hex	SD Memory Card Access Failure	SD Memory Card access failed when an instruction was executed.	<ul style="list-style-type: none"> An SD Memory Card is either not inserted or is not inserted properly. The SD Memory Card is broken. The SD Memory Card slot is broken. 				○		page 3-263
54011401 hex	SD Memory Card Write-protected	An attempt was made to write to a write-protected SD Memory Card when an instruction was executed.	<ul style="list-style-type: none"> An attempt was made to write to a write-protected SD Memory Card. 				○		page 3-263

Event code	Event name	Meaning	Assumed cause	Level					Reference
				M a j	P r t	M i n	O b s	I n f o	
54011402 hex	SD Memory Card Insufficient Capacity	The capacity of the SD Memory Card was insufficient when writing to the SD Memory Card for an instruction.	<ul style="list-style-type: none"> The SD Memory Card has run out of free space. 				○		page 3-264
54011403 hex	File Does Not Exist	The file specified for an instruction does not exist. Or, the specified file is corrupted.	<ul style="list-style-type: none"> The specified file does not exist. The specified file is corrupted. The SD Memory Card cannot be normally accessed due to a contact failure or other causes. 				○		page 3-264
54011404 hex	Too Many Files/Directories	The maximum number of files/directories was exceeded when creating a file/directory for an instruction.	<ul style="list-style-type: none"> The number of files or directories exceeded the maximum number. 				○		page 3-265
54011405 hex	File Already in Use	A file specified for an instruction cannot be accessed because it is already being used.	<ul style="list-style-type: none"> An instruction attempted to read or write a file already being accessed by another instruction. 				○		page 3-266
54011406 hex	Open Mode Mismatch	A file operation for an instruction was inconsistent with the open mode of the file.	<ul style="list-style-type: none"> The file open mode specified by the Open File instruction does not match the file operation attempted by a subsequent SD Memory Card instruction. 				○		page 3-266
54011407 hex	Offset Out of Range	Access to the address is not possible for the offset specified for an instruction.	<ul style="list-style-type: none"> An attempt was made to access beyond the size of the file. 				○		page 3-267
54011408 hex	Directory Not Empty	A directory was not empty when the Delete Directory instruction was executed or when an attempt was made to change the directory name.	<ul style="list-style-type: none"> A directory was not empty when the Delete Directory instruction was executed. A directory contained another directory when an attempt was made to change the directory name. 				○		page 3-267
54011409 hex	That File Name Already Exists	An instruction could not be executed because the file name specified for the instruction already exists.	<ul style="list-style-type: none"> A file already exists with the same name as the name specified for the instruction to create. 				○		page 3-268
5401140A hex	Write Access Denied	An attempt was made to write to a write-protected file or directory when an instruction was executed.	<ul style="list-style-type: none"> The file or directory specified for the instruction to write is write-protected. 				○		page 3-268

Event code	Event name	Meaning	Assumed cause	Level					Reference
				M a j	P r t	M i n	O b s	I n f o	
5401140B hex	Too Many Files Open	The maximum number of open files was exceeded when opening a file for an instruction.	<ul style="list-style-type: none"> The maximum number of open files was exceeded when opening a file for an instruction. 				○		page 3-269
5401140C hex	Directory Does Not Exist	The directory specified for an instruction does not exist.	<ul style="list-style-type: none"> The directory specified for an instruction does not exist. 				○		page 3-269
5401140D hex	File or Directory Name Is Too Long	The file name or directory name that was specified for an instruction is too long.	<ul style="list-style-type: none"> The file name or directory name that was specified for the instruction to create is too long. 				○		page 3-270
5401140E hex	SD Memory Card Access Failed	SD Memory Card access failed.	<ul style="list-style-type: none"> The SD Memory Card is broken. The SD Memory Card slot is broken. 				○		page 3-270
5401140F hex (Ver. 1.08 or later)	Backup Operation Already in Progress	Another backup operation is already in progress.	<ul style="list-style-type: none"> Another backup operation is already in progress. 				○		page 3-271
54011410 hex (Ver. 1.08 or later)	Cannot Execute Backup	Execution of a backup operation was not possible because execution of another operation was in progress.	<ul style="list-style-type: none"> Execution of the instruction was attempted during execution of online editing. Execution of the instruction was attempted during execution of a Save Cam Table instruction. Execution of the instruction was attempted while a CPU Unit name change operation was in progress. 				○		page 3-272
54011411 hex (Ver. 1.08 or later)	Unit/Slave Backup Failed	A Unit/slave backup operation failed.	<ul style="list-style-type: none"> A Unit/slave backup operation failed. 				○		page 3-273
54011800 hex	EtherCAT Communications Error	Accessing the EtherCAT network failed when an instruction was executed.	<ul style="list-style-type: none"> The EtherCAT network is not in a usable status. 				○		page 3-273
54011801 hex	EtherCAT Slave Does Not Respond	Accessing the target slave failed when an instruction was executed.	<ul style="list-style-type: none"> The target slave does not exist. The target slave is not in an operating condition. 				○		page 3-274
54011802 hex	EtherCAT Timeout	A timeout occurred while trying to access an EtherCAT slave when an instruction was executed.	<ul style="list-style-type: none"> Communications with the target slave timed out. 				○		page 3-274

Event code	Event name	Meaning	Assumed cause	Level					Reference
				M a j	P r t	M i n	O b s	I n f o	
54011803 hex	Reception Buffer Overflow	The receive data from an EtherCAT slave overflowed the receive buffer when an instruction was executed.	<ul style="list-style-type: none"> The receive data from the slave overflowed the receive buffer. 				○		page 3-275
54011804 hex	SDO Abort Error	An SDO abort error was received from an EtherCAT slave when an instruction was executed.	<ul style="list-style-type: none"> Depends on the specifications of the slave. 				○		page 3-275
54011805 hex	Saving Packet Monitor File	An instruction for packet monitoring was executed while saving an EtherCAT packet monitor file.	<ul style="list-style-type: none"> An instruction for packet monitoring was executed while saving an EtherCAT packet monitor file. 				○		page 3-276
54011806 hex	Packet Monitoring Function Not Started	A Stop EtherCAT Packet Monitor instruction was executed when EtherCAT packet monitoring was stopped.	<ul style="list-style-type: none"> A Stop EtherCAT Packet Monitor instruction was executed when EtherCAT packet monitoring was stopped. 				○		page 3-276
54011807 hex	Packet Monitoring Function in Operation	A Start EtherCAT Packet Monitor instruction was executed when EtherCAT packet monitoring was already being executed.	<ul style="list-style-type: none"> The Start EtherCAT Packet Monitor instruction was executed again while the EtherCAT packet monitoring function was already in operation. 				○		page 3-277

Event code	Event name	Meaning	Assumed cause	Level					Reference
				M a j	P r t	M i n	O b s	I n f o	
54011808 hex	Communications Resource Overflow	More than 32 EtherCAT communications instructions/IO-Link communications instructions were executed at the same time.	<ul style="list-style-type: none"> More than 32 EtherCAT communications instructions/IO-Link communications instructions were executed at the same time. The EtherCAT communications instructions/IO-Link communications instructions are listed below. EC_CoESDOWrite instruction EC_CoESDORead instruction EC_ConnectSlave instruction EC_DisconnectSlave instruction EC_ChangeEnableSetting instruction EC_StartMon instruction EC_SaveMon instruction EC_StopMon instruction EC_CopyMon instruction IOL_ReadObj instruction IOL_WriteObj instruction EC_GetMasterStatistics instruction EC_ClearMasterStatistics instruction EC_GetSlaveStatistics instruction EC_ClearSlaveStatistics instruction 				○		page 3-278
54011809 hex (Ver. 1.01 or later)	Packet Monitoring Function Not Supported	Packets cannot be monitored.	<ul style="list-style-type: none"> An instruction for packet monitoring was executed for a CPU Unit that does not support packet monitoring. 				○		page 3-279
5401180A hex (Ver. 1.40 or later)	Cannot Execute Instruction to Slave	An instruction was executed for a slave that cannot execute an instruction.	<ul style="list-style-type: none"> The EC_DisconnectSlave or EC_ConnectSlave instruction was executed for a disabled slave. The EC_ChangeEnableSetting instruction was executed for a disconnected slave. The EC_DisconnectSlave or EC_ChangeEnableSetting instruction was executed for a slave in the ring topology. 				○		page 3-280

Event code	Event name	Meaning	Assumed cause	Level					Reference
				M a j	P r t	M i n	O b s	I n f o	
5401180D hex (Ver. 1.64 or later and Project Unit Ver. 1.64 or later)	Diagnosis/ Statistics Log Execut- ing	A master/slave diag- nostic and statistical information instruc- tion cannot be exe- cuted because the di- agnosis/statistics log is in operation.	<ul style="list-style-type: none"> A master diagnostic and statisti- cal information instruction (EC_GetMasterStatistics or EC_ClearMasterStatistics), or a slave diagnostic and statisti- cal information instruction (EC_GetSlaveStatistics or EC_ClearSlaveStatistics) was executed while the diagnosis/ statistics log was in operation. 				○		page 3-281
5401180E hex (Ver. 1.64 or later and Project Unit Ver. 1.64 or later)	Master Diag- nostic and Statistical In- formation In- struction Multi-execu- tion Disabled	A master diagnostic and statistical infor- mation instruction cannot be executed because more than one master diagnos- tic and statistical in- formation instruction was executed simul- taneously.	<ul style="list-style-type: none"> A master diagnostic and statisti- cal information instruction was executed during execution of the master diagnostic and statistical information instruc- tion (EC_GetMasterStatistics or EC_ClearMasterStatistics). 				○		page 3-282
5401180F hex (Ver. 1.64 or later and Project Unit Ver. 1.64 or later)	Slave Diag- nostic and Statistical In- formation In- struction Multi-execu- tion Disabled	A slave diagnostic and statistical infor- mation instruction cannot be executed because more than one slave diagnostic and statistical infor- mation instruction was executed simul- taneously.	<ul style="list-style-type: none"> A slave diagnostic and statisti- cal information instruction was executed during execution of the slave diagnostic and statisti- cal information instruction (EC_GetSlaveStatistics or EC_ClearSlaveStatistics). 				○		page 3-283
54011C00 hex	Explicit Mes- sage Error	An error response code was returned for an explicit message that was sent with a CIP communications instruction.	<ul style="list-style-type: none"> Depends on the nature of the error. 				○		page 3-284
54011C01 hex	Incorrect Route Path	The format of the route path that is specified for a CIP communications in- struction is not cor- rect.	<ul style="list-style-type: none"> The format of the route path that is specified for a CIP com- munications instruction is not correct. Address resolution failed for the host name that was speci- fied in a CIP communications instruction. 				○		page 3-284
54011C02 hex	CIP Handle Out of Range	The handle that is specified for the CIP communications in- struction is not cor- rect.	<ul style="list-style-type: none"> The handle that is specified for the CIP communications in- struction is not correct. 				○		page 3-285

Event code	Event name	Meaning	Assumed cause	Level					Reference
				M a j	P r t	M i n	O b s	I n f o	
54011C03 hex	CIP Communications Resource Overflow	The maximum resources that you can use for CIP communications instructions at the same time was exceeded.	<ul style="list-style-type: none"> More than 32 CIP communications instructions were executed at the same time. An attempt was made to use more than 32 handles at the same time. 				○		page 3-285
54011C04 hex	CIP Timeout	A CIP timeout occurred during execution of a CIP communications instruction.	<ul style="list-style-type: none"> A device does not exist for the specified IP address. The CIP connection for the specified handle timed out and was closed. Power to the remote device is OFF. Communications are stopped at the remote device. CIP Message Communications are stopped at the remote device. The Ethernet cable connector for EtherNet/IP is disconnected. The Ethernet cable for EtherNet/IP is disconnected. Packets of the instruction are not allowed by the Firewall function or Packet Filter function of the remote device or devices on the communication path. Noise 				○		page 3-286
54011C05 hex (Ver. 1.06 or later)	Class-3 Connection Not Established	Establishing a class-3 connection failed for a CIP communications instruction.	<ul style="list-style-type: none"> The CIPOpen instruction was executed for a device that does not support class 3 (Large_Forward_Open). The CIPOpenWithDataSize instruction was executed with a specified data size of 510 bytes or larger for a device that does not support class 3 (Large_Forward_Open). 				○		page 3-287
54011C06 hex (Ver. 1.06 or later)	CIP Communications Data Size Exceeded	An attempt was made to send a class-3 explicit message with a data size that is larger than the sendable size with a CIP communications instruction.	<ul style="list-style-type: none"> The data size that was specified for the input variable to the CIPRead, CIPWrite, or CIP-Send instruction exceeded the data size that was specified with the CIPOpenWithDataSize instruction. 				○		page 3-288
54012000 hex	Local IP Address Setting Error	An instruction was executed when there was a setting error in the local IP address.	<ul style="list-style-type: none"> An instruction was executed when there was a setting error in the local IP address. 				○		page 3-289

Event code	Event name	Meaning	Assumed cause	Level					Reference
				M a j	P r t	M i n	O b s	I n f o	
54012001 hex	TCP/UDP Port Already in Use	The UDP or TCP port was already in use when the instruction was executed.	<ul style="list-style-type: none"> The UDP or TCP port is already in use. 				○		page 3-289
54012002 hex	Address Resolution Failed	Address resolution failed for a remote node with the host name that was specified in the instruction.	<ul style="list-style-type: none"> The host name specified for the instruction is not correct. The hosts and DNS settings in the Controller are incorrect. The DNS server settings are incorrect. 				○		page 3-290
54012003 hex	Socket Status Error	The status was not suitable for execution of the socket service instruction.	<ul style="list-style-type: none"> SkUDPCreate Instruction <ul style="list-style-type: none"> The UDP port specified with the <i>SrcUdpPort</i> input variable is in one of the following states. <ul style="list-style-type: none"> It is already open. It is being closed. SkUDPRcv Instruction <ul style="list-style-type: none"> The specified socket is receiving data. The specified socket is closed. SkUDPSend Instruction <ul style="list-style-type: none"> The specified socket is sending data. The specified socket is closed. SkTCPAccept Instruction <ul style="list-style-type: none"> The specified TCP port is in one of the following states. <ul style="list-style-type: none"> The port is being opened. The port is being closed. A connection is already established for this instruction for the same IP address and TCP port. SkTCPConnect Instruction <ul style="list-style-type: none"> The TCP port that is specified with the <i>SrcTcpPort</i> input variable is already open. The remote node that is specified with <i>DstAdr</i> input variable does not exist. The remote node that is specified with <i>DstAdr</i> and <i>DstTcpPort</i> input variables is not waiting for a connection. 				○		page 3-291

Event code	Event name	Meaning	Assumed cause	Level					Reference
				M a j	P r t	M i n	O b s	I n f o	
			<ul style="list-style-type: none"> • SktTCPRcv Instruction <ul style="list-style-type: none"> • The specified socket is receiving data. • The specified socket is closed. • The specified socket handle is already used for secure socket communications. • SktTCPSEND Instruction <ul style="list-style-type: none"> • The specified socket is sending data. • The specified socket is closed. • The send buffer of the specified socket is full (because the power to the remote node is OFF, the line is disconnected, etc.) • The specified socket handle is already used for secure socket communications. • SktClearBuf Instruction <ul style="list-style-type: none"> • The specified socket handle is already used for secure socket communications. • [NX102 and NX1P2 CPU Units Ver. 1.50 or later and NX502 CPU Units Ver. 1.60 or later] SktTLSConnect Instruction <ul style="list-style-type: none"> • The specified socket handle is already used for secure socket communications. • [NX102, NX502] ModbusTCPCmd Instruction <ul style="list-style-type: none"> • When the socket is being processed. • When the socket is closed. • The specified socket handle is already used for secure socket communications. • [NX102, NX502] ModbusTCPRead Instruction <ul style="list-style-type: none"> • When the socket is being processed. • When the socket is closed. • The specified socket handle is already used for secure socket communications. 						

Event code	Event name	Meaning	Assumed cause	Level					Reference
				M a j	P r t	M i n	O b s	I n f o	
			<ul style="list-style-type: none"> [NX102, NX502] ModbusTCPWrite Instruction When the socket is being processed. When the socket is closed. The specified socket handle is already used for secure socket communications. SkSetOption instruction The specified socket already started communications. The option type not supported by the specified socket was specified. 						
54012004 hex	Local IP Address Not Set	The local IP address was not set when a socket service instruction was executed.	<ul style="list-style-type: none"> There is a BOOTP server setting error. The BOOTP server does not exist. The local IP address is not set because operation just started. 				○		page 3-293
54012006 hex	Socket Timeout	A timeout occurred for a socket service instruction.	<ul style="list-style-type: none"> SkTCPAccept instruction: There was no request for a connection from the remote node during the user-set timeout time. SkTCPRecv or SkUDPRecv instruction: Data was not received from the remote node during the user-set timeout time. 				○		page 3-294
54012007 hex	Socket Handle Out of Range	The handle that is specified for the socket service instruction is not correct.	<ul style="list-style-type: none"> The handle that is specified for the socket service instruction is not correct. 				○		page 3-295
54012008 hex	Socket Communications Resource Overflow	The maximum resources that you can use for socket service instructions at the same time was exceeded.	<ul style="list-style-type: none"> More than 32 socket service instructions were executed at the same time (64 for NX102). More than 30 socket handles were used at the same time (60 for NX102, 16 for CPU Units with unit version 1.02 or earlier). 				○		page 3-296
5401200A hex (Ver. 1.46 or later) [NX102-□□00, NX1P2-□□□□□□] (Ver.1.37 or later) [NX102-□□20] (Ver. 1.60 or later) [NX502-1□00]	Invalid TLS Session Name	The specified TLS session name is not found in the secure socket setting.	The specified TLS session name is not set in the secure socket setting.				○		page 3-297

Event code	Event name	Meaning	Assumed cause	Level					Reference
				M a j	P r t	M i n	O b s	I n f o	
5401200B hex (Ver. 1.46 or later) [NX102-□□00, NX1P2- □□□□□□] (Ver.1.37 or later) [NX102-□□20] (Ver. 1.60 or later) [NX502-1□00]	Access to the Certifi- cate Failed	Access to the certifi- cate failed because the certificate and se- cure socket setting have not been trans- ferred or the certifi- cate has a password set.	<ul style="list-style-type: none"> Client certificate has not been transferred to the Controller. A password is set for the forwarded client certificate. The secure socket setting does not exist or the contents of the secure socket setting are incorrect. 				○		page 3-298
5401200C hex (Ver. 1.46 or later) [NX102-□□00, NX1P2- □□□□□□] (Ver.1.37 or later) [NX102-□□20] (Ver. 1.60 or later) [NX502-1□00]	TLS Session Establish- ment Error	Establishment of a TLS session failed.	<ul style="list-style-type: none"> Client certificate has not been transferred to the Controller. The contents of the client private key are incorrect. Establishment of secure socket communications failed. 				○		page 3-299
5401200E hex (Ver. 1.46 or later) [NX102-□□00, NX1P2- □□□□□□] (Ver.1.37 or later) [NX102-□□20] (Ver. 1.60 or later) [NX502-1□00]	Invalid TLS Session Handle	The TLS session handle specified by the secure socket service instruction is invalid.	The TLS session handle speci- fied by the secure socket service instruction is invalid.				○		page 3-300
5401200F hex (Ver. 1.46 or later) [NX102-□□00, NX1P2- □□□□□□] (Ver.1.37 or later) [NX102-□□20] (Ver. 1.60 or later) [NX502-1□00]	TLS Error	An error occurred during secure socket communications.	An error occurred during secure socket communications.				○		page 3-300

Event code	Event name	Meaning	Assumed cause	Level					Reference
				M a j	P r t	M i n	O b s	I n f o	
54012400 hex (Ver. 1.02 or later)	No Execution Right	An instruction to change the settings of an EtherNet/IP port was executed when execution was not possible.	<ul style="list-style-type: none"> An instruction to change the settings of the EtherNet/IP port, Ethernet port, or a CJ-series EtherNet/IP Unit was executed when restart processing was in progress for the EtherNet/IP port or Ethernet port. An instruction to change the settings of a CJ-series EtherNet/IP Unit was executed when restart processing was in progress for the Unit. An instruction to change the settings of the EtherNet/IP port, Ethernet port, or a CJ-series EtherNet/IP Unit was executed while the settings for an EtherNet/IP port or Ethernet port are being changed by an instruction or CIP messages. An instruction to change the settings of a CJ-series EtherNet/IP Unit was executed when changing settings was in progress for an instruction or CIP message for the Unit. The Unit (or unit number) specified in the instruction does not specify an EtherNet/IP port, Ethernet port, or CJ-series EtherNet/IP Unit. 				○		page 3-301
54012401 hex (Ver. 1.02 or later)	Settings Update Failed	It was not possible to update the settings of the CJ-series EtherNet/IP Unit that were changed.	<ul style="list-style-type: none"> Restart processing for a Unit or built-in EtherNet/IP port was started during execution of an instruction to change the settings of a CJ-series EtherNet/IP Unit. 				○		page 3-302
54012402 hex (Ver. 1.02 or later)	Too Many Simultaneous Instruction Executions	Too many instructions to change the communications setup of the Controller were executed at the same time.	<ul style="list-style-type: none"> Two or more instructions to change the communications setup of the Controller were executed at the same time. 				○		page 3-302
54012403 hex (Ver. 1.08 or later)	FTP Client Execution Limit Exceeded	Too many FTP client communications instructions were executed at the same time.	<ul style="list-style-type: none"> Four or more FTP client communications instructions were executed at the same time. 				○		page 3-303

Event code	Event name	Meaning	Assumed cause	Level					Reference
				M a j	P r t	M i n	O b s	I n f o	
54012404 hex (Ver. 1.08 or later)	File Number Limit Ex- ceeded	The number of files specified with a wildcard for an FTP client communications instruction exceeded 1,000.	<ul style="list-style-type: none"> The number of files specified with a file name that contained a wildcard for an FTP client communications instruction exceeded 1,000. 				○		page 3-303
54012405 hex (Ver. 1.08 or later)	Directory Does Not Exist (FTP)	The directory specified for an FTP client communications instruction does not exist in the Controller or an incorrect path was specified.	<ul style="list-style-type: none"> The directory specified for an FTP client communications instruction does not exist in the Controller or an incorrect path was specified. 				○		page 3-304
54012406 hex (Ver. 1.08 or later)	FTP Server Connection Error	The destination FTP server that was specified for an FTP client communications instruction does not exist on the network or the specified FTP server is not operating.	<ul style="list-style-type: none"> The destination FTP server that was specified for an FTP client communications instruction does not exist on the network. The destination FTP server that was specified for an FTP client communications instruction is not operating. FTP communications are not allowed by the designated destination FTP server or the Firewall function or Packet Filter function of the devices on the communication path. 				○		page 3-305
54012407 hex (Ver. 1.08 or later)	Destination FTP Server Execution Failure	The destination FTP server for an FTP client communications instruction returned an error.	<ul style="list-style-type: none"> The destination FTP server for the FTP client communications instruction failed to execute the requested processing. When the Controller's Packet Filter function is enabled, packets from the FTP server are not allowed.*1 				○		page 3-306
54012408 hex (Ver. 1.08 or later)	SD Memory Card Access Failed for FTP	SD Memory Card access from the FTP client failed.	<ul style="list-style-type: none"> An SD Memory Card is not inserted. The SD Memory Card was removed during execution of the FTP client communications instruction. The capacity of the SD Memory Card is insufficient. The SD Memory Card is write protected. 				○		page 3-307
54012409 hex (Ver. 1.08 or later)	Specified File Does Not Exist	A file specified for an FTP client communications instruction does not exist in the Controller.	<ul style="list-style-type: none"> A file specified for an FTP client communications instruction does not exist in the Controller. 				○		page 3-308

Event code	Event name	Meaning	Assumed cause	Level					Reference
				M a j	P r t	M i n	O b s	I n f o	
5401240A hex (Ver. 1.08 or later)	Specified File Is Write Protected	The data was not transferred because the FTP client communications instruction was set to not overwrite files with the same name.	<ul style="list-style-type: none"> The data was not transferred because the FTP client communications instruction was set to not overwrite files with the same name and a file with the specified file name already existed at the destination. 				○		page 3-308
5401240B hex (Ver. 1.08 or later)	Failed To Delete Specified File	A file was not deleted after it was transferred with an FTP client communications instruction.	<ul style="list-style-type: none"> The FTP client communications instruction was set to delete files after they are transferred, but it was not possible to delete the specified file because it had a read-only attribute. It was not possible to delete the file specified for the FTP client communications instruction because it was in use by another application. 				○		page 3-309
5401240C hex (Ver. 1.08 or later)	Specified File Access Failed	An FTP transfer for an FTP client communications instruction failed because file access failed.	<ul style="list-style-type: none"> The file specified for the FTP client communications instruction was in use by another application. The file or directory specified for the FTP client communications instruction to write is write protected. 				○		page 3-310
5401240D hex (Ver. 1.10 or later)	IP Address Setting Invalid	Instruction execution was not possible because there is an error between the IP address setting of the port specified in the instruction and the other port settings.	<ul style="list-style-type: none"> The network address of the port specified in the instruction is the same as the network address of another port. Both the port specified in the instruction and all other ports are set as unused ports. 				○		page 3-311
54012C00 hex (Ver. 1.05 or later)	NX Message Error	An error response code was returned for an NX message.	<ul style="list-style-type: none"> Depends on the nature of the error. 				○		page 3-312
54012C01 hex (Ver. 1.05 or later)	NX Message Resource Overflow	The maximum resources that you can use for NX message instructions at the same time was exceeded.	<ul style="list-style-type: none"> More than 32 NX message instructions were executed at the same time. 				○		page 3-312

Event code	Event name	Meaning	Assumed cause	Level					Reference
				M a j	P r t	M i n	O b s	I n f o	
54012C02 hex (Ver. 1.05 or later)	NX Message Timeout	A timeout occurred during execution of an NX message.	<ul style="list-style-type: none"> The specified NX Unit does not exist. The NX message was closed because it timed out. Power to the remote Unit is OFF. Communications are stopped at the remote Unit. The communications cable connector is disconnected. The communications cable is broken. Noise 				○		page 3-313
54012C03 hex (Ver. 1.05 or later)	Incorrect NX Message Length	The length of the NX message is not correct.	<ul style="list-style-type: none"> The size that is specified for WriteDat or Path is too long. 				○		page 3-314
54012C05 hex (Ver. 1.05 or later)	NX Message EtherCAT Network Error	An error occurred in EtherCAT communications on the NX message path.	<ul style="list-style-type: none"> An error occurred in EtherCAT communications on the NX message path. 				○		page 3-314
54012C06 hex (Ver. 1.05 or later)	External Restart Already Executed for Specified NX Units	A restart was already in execution from the Sysmac Studio when the instruction was executed.	<ul style="list-style-type: none"> A restart was already in execution from the Sysmac Studio when the instruction was executed. 				○		page 3-315
54012C07 hex (Ver. 1.05 or later)	Unapplicable Unit Specified for Instruction	A slave that cannot be specified for the instruction was connected at the slave node address of the specified Unit.	<ul style="list-style-type: none"> A slave that cannot be specified for the instruction was connected to the slave node address of the specified Unit. 				○		page 3-315
54012C08 hex (Ver. 1.10 or later)	Invalid Total Power ON Time Record	Failed to read the total power ON time.	<ul style="list-style-type: none"> Non-volatile memory failure 				○		page 3-316
54013461 hex	Process Data Object Setting Missing	The PDO mapping is not correct.	<ul style="list-style-type: none"> The PDOs that are required for the motion control instruction are not mapped. The relevant instruction was executed for a device that does not have an object that supports the instruction. A motion control instruction that specifies phase Z (<code>_mcEncoderMark</code>) as the trigger conditions was executed for an axis that is mapped to an OMRON GXEC02□□ EtherCAT Encoder slave. 				○		page 3-317
54014800 hex (Ver. 1.12 or later)	Device Error Received	An error response from the device was received.	<ul style="list-style-type: none"> An error response from the device was received. 				○		page 3-318

Event code	Event name	Meaning	Assumed cause	Level					Reference
				M a j	P r t	M i n	O b s	I n f o	
54014801 hex (Ver. 1.12 or later)	Specified Unit Does Not Exist	The specified Unit does not exist.	<ul style="list-style-type: none"> The IO-Link master is not connected to or mounted on the specified position. 				○		page 3-318
54014802 hex (Ver. 1.12 or later)	Message Processing Limit Exceeded	An instruction cannot be executed because the IO-Link master is processing the message from another application.	<ul style="list-style-type: none"> An instruction cannot be executed because the IO-Link master is processing the message from another application (an instruction execution or a tool connection). 				○		page 3-319
54014803 hex (Ver. 1.12 or later)	Specified Unit Status Error	The specified Unit is not in a condition to receive messages.	<ul style="list-style-type: none"> The specified Unit is not in a condition to receive messages. 				○		page 3-319
54014804 hex (Ver. 1.12 or later)	Too Many Simultaneous Instruction Executions	The number of instructions that can be simultaneously executed was exceeded.	<ul style="list-style-type: none"> More than 32 NX message instructions and EtherCAT communications instructions were executed at the same time. 				○		page 3-320
54014805 hex (Ver. 1.12 or later)	Communications Timeout	A timeout occurred in communications.	<ul style="list-style-type: none"> The communications timeout time is shorter than the message response time. The cable for EtherCAT or for IO-Link is broken. Noise Device failure 				○		page 3-321
54014806 hex (Ver. 1.12 or later)	Invalid Mode	The specified IO-Link master port is not the IO-Link mode.	<ul style="list-style-type: none"> The specified IO-Link master port is not the IO-Link mode. 				○		page 3-321
54014807 hex (Ver. 1.12 or later)	I/O Power OFF Status	The I/O power is not supplied to the specified IO-Link master port.	<ul style="list-style-type: none"> The I/O power is not supplied to the specified IO-Link master port. 				○		page 3-322
54014808 hex (Ver. 1.12 or later)	Verification Error	The specified IO-Link master port had a verification error or a communications error.	<ul style="list-style-type: none"> The specified IO-Link master port had a verification error or a communications error. 				○		page 3-322
54014809 hex (Ver. 1.12 or later)	Incorrect Device Port Setting	The device port settings are not correct.	<ul style="list-style-type: none"> The device port settings are not correct. 				○		page 3-323
54015420 hex	Electronic Gear Ratio Numerator Setting Out of Range	The parameter specified for the <i>RatioNumerator</i> input variable to a motion control instruction is out of range.	<ul style="list-style-type: none"> Instruction input parameter exceeded the valid range of the input variable. 				○		page 3-323
54015421 hex	Electronic Gear Ratio Denominator Setting Out of Range	The parameter specified for the <i>RatioDenominator</i> input variable to a motion control instruction is out of range.	<ul style="list-style-type: none"> Instruction input parameter exceeded the valid range of the input variable. 				○		page 3-324

Event code	Event name	Meaning	Assumed cause	Level					Reference
				M a j	P r t	M i n	O b s	I n f o	
54015422 hex	Target Velocity Setting Out of Range	The parameter specified for the <i>Velocity</i> input variable to a motion control instruction is out of range.	<ul style="list-style-type: none"> Instruction input parameter exceeded the valid range of the input variable. 				○		page 3-324
54015423 hex	Acceleration Setting Out of Range	The parameter specified for the <i>Acceleration</i> input variable to a motion control instruction is out of range.	<ul style="list-style-type: none"> Instruction input parameter exceeded the valid range of the input variable. 				○		page 3-325
54015424 hex	Deceleration Setting Out of Range	The parameter specified for the <i>Deceleration</i> input variable to a motion control instruction is out of range.	<ul style="list-style-type: none"> Instruction input parameter exceeded the valid range of the input variable. 				○		page 3-325
54015425 hex	Jerk Setting Out of Range	The parameter specified for the <i>Jerk</i> input variable to a motion control instruction is out of range.	<ul style="list-style-type: none"> Instruction input parameter exceeded the valid range of the input variable. 				○		page 3-326
54015427 hex	Torque Ramp Setting Out of Range	The parameter specified for the <i>TorqueRamp</i> input variable to a motion control instruction is out of range.	<ul style="list-style-type: none"> Instruction input parameter exceeded the valid range of the input variable. 				○		page 3-326
54015428 hex	Master Coefficient Scaling Out of Range	The parameter specified for the <i>MasterScaling</i> input variable to a motion control instruction is out of range.	<ul style="list-style-type: none"> Instruction input parameter exceeded the valid range of the input variable. 				○		page 3-327
54015429 hex	Slave Coefficient Scaling Out of Range	The parameter specified for the <i>SlaveScaling</i> input variable to a motion control instruction is out of range.	<ul style="list-style-type: none"> Instruction input parameter exceeded the valid range of the input variable. 				○		page 3-327
5401542A hex	Feeding Velocity Setting Out of Range	The parameter specified for the <i>FeedVelocity</i> input variable to a motion control instruction is out of range.	<ul style="list-style-type: none"> The Feed Velocity (input variable <i>FeedVelocity</i>) is still at the default (0). 				○		page 3-328

Event code	Event name	Meaning	Assumed cause	Level					Reference
				M a j	P r t	M i n	O b s	I n f o	
5401542B hex	Buffer Mode Selection Out of Range	The parameter specified for the <i>BufferMode</i> input variable to a motion control instruction is out of range.	<ul style="list-style-type: none"> Instruction input parameter exceeded the valid range of the input variable. 				○		page 3-328
5401542C hex	Coordinate System Selection Out of Range	The parameter specified for the <i>CoordSystem</i> input variable to a motion control instruction is out of range.	<ul style="list-style-type: none"> Instruction input parameter exceeded the valid range of the input variable. 				○		page 3-329
5401542D hex	Circular Interpolation Mode Selection Out of Range	The parameter specified for the <i>CircMode</i> input variable to a motion control instruction is out of range.	<ul style="list-style-type: none"> Instruction input parameter exceeded the valid range of the input variable. 				○		page 3-329
5401542E hex	Direction Selection Out of Range	The parameter specified for the <i>Direction</i> input variable to a motion control instruction is out of range.	<ul style="list-style-type: none"> Instruction input parameter exceeded the valid range of the input variable. 				○		page 3-330
5401542F hex	Path Selection Out of Range	The parameter specified for the <i>PathChoice</i> input variable to a motion control instruction is out of range.	<ul style="list-style-type: none"> Instruction input parameter exceeded the valid range of the input variable. 				○		page 3-330
54015430 hex	Position Type Selection Out of Range	The parameter specified for the <i>ReferenceType</i> input variable to a motion control instruction is out of range.	<ul style="list-style-type: none"> Instruction input parameter exceeded the valid range of the input variable. 				○		page 3-331
54015431 hex	Travel Mode Selection Out of Range	The parameter specified for the <i>MoveMode</i> input variable to a motion control instruction is out of range.	<ul style="list-style-type: none"> Instruction input parameter exceeded the valid range of the input variable. 				○		page 3-331
54015432 hex	Transition Mode Selection Out of Range	The parameter specified for the <i>TransitionMode</i> input variable to a motion control instruction is out of range.	<ul style="list-style-type: none"> Instruction input parameter exceeded the valid range of the input variable. <i>_mcAborting</i> or <i>_mcBuffered</i> was specified for <i>BufferMode</i> and <i>_mcTMCornerSuperimposed</i> was specified for <i>TransitionMode</i>. 				○		page 3-332

Event code	Event name	Meaning	Assumed cause	Level					Reference
				M a j	P r t	M i n	O b s	I n f o	
54015433 hex	Continue Method Selection Out of Range	The value of the reserved input variable <i>Continuous</i> to a motion control instruction changed.	<ul style="list-style-type: none"> The value of the reserved input variable <i>Continuous</i> changed. 				○		page 3-332
54015434 hex	Combine Mode Selection Out of Range	The parameter specified for the <i>CombineMode</i> input variable to a motion control instruction is out of range.	<ul style="list-style-type: none"> Instruction input parameter exceeded the valid range of the input variable. 				○		page 3-333
54015435 hex	Synchronization Start Condition Selection Out of Range	The parameter specified for the <i>LinkOption</i> input variable to a motion control instruction is out of range.	<ul style="list-style-type: none"> Instruction input parameter exceeded the valid range of the input variable. 				○		page 3-333
54015436 hex	Master and Slave Defined as Same Axis	The same axis is specified for the <i>Master</i> and <i>Slave</i> input variables to a motion control instruction.	<ul style="list-style-type: none"> The parameter is the same for the <i>Master</i> and <i>Slave</i> input variables to the instruction. 				○		page 3-334
54015437 hex	Master and Auxiliary Defined as Same Axis	The same axis is specified for the <i>Master</i> and <i>Auxiliary</i> input variables to a motion control instruction.	<ul style="list-style-type: none"> The parameter is the same for the <i>Master</i> and <i>Auxiliary</i> input variables to the instruction. 				○		page 3-334
54015438 hex	Master/ Slave Axis Numbers Not in Ascending Order	The axis numbers specified for the <i>Master</i> and <i>Slave</i> input variables to a motion control instruction are not in ascending order.	<ul style="list-style-type: none"> The parameters for the <i>Master</i> and <i>Slave</i> input variables to the instruction were not in ascending order when <i>_mclAttestCommand</i> was specified for the <i>ReferenceType</i> input variable to the instruction. 				○		page 3-335
54015439 hex	Incorrect Cam Table Specification	The parameter specified for the <i>CamTable</i> input variable to a motion control instruction is out of range.	<ul style="list-style-type: none"> Something other than a cam data variable was specified for the <i>CamTable</i> input variable to the instruction. 				○		page 3-335

Event code	Event name	Meaning	Assumed cause	Level					Reference
				M a j	P r t	M i n	O b s	I n f o	
5401543A hex	Synchroni- zation Stop- ped	A synchronized control motion control instruction was executed, but conditions required for execution were not met.	<ul style="list-style-type: none"> The MC_CamOut (End Cam Operation) instruction was executed even though the MC_CamIn (Start Cam Operation) or MC_CamInCurve (Start Cam Operation With Specified Curve) instruction is not being executed. The MC_GearOut (End Gear Operation) instruction was executed even though the MC_GearIn (Start Gear Operation), the MC_GearInPos (Positioning Gear Operation), or MC_GearInPos2 (Positioning Gear Operation2) instruction is not being executed. The MC_Phasing (Shift Master Axis Phase) instruction was executed even though the MC_CamIn (Start Cam Operation), MC_CamInCurve (Start Cam Operation With Specified Curve), MC_GearIn (Start Gear Operation), MC_GearInPos (Positioning Gear Operation), MC_GearInPos2 (Positioning Gear Operation2), or MC_MoveLink (Synchronous Positioning) instruction is not being executed. 					○	page 3-336
5401543B hex	Motion Control Instruction Re-execution Disabled	An attempt was made to re-execute a motion control instruction that cannot be re-executed.	<ul style="list-style-type: none"> A motion control instruction that cannot be re-executed was re-executed. 					○	page 3-338
5401543C hex	Motion Control Instruction Multi-execution Disabled	Multiple functions that cannot be executed simultaneously were executed for the same target (MC common, axis, or axes group).	<ul style="list-style-type: none"> Multiple functions that cannot be executed simultaneously were executed for the same target (MC common or axis). 					○	page 3-339
5401543D hex	Instruction Not Allowed for Encoder Axis Type	An operation instruction was executed for an encoder axis.	<ul style="list-style-type: none"> An operation instruction was executed for an encoder axis. 					○	page 3-339

Event code	Event name	Meaning	Assumed cause	Level					Reference
				M a j	P r t	M i n	O b s	I n f o	
5401543E hex	Instruction Cannot Be Executed during Multi-axes Coordinated Control	<ul style="list-style-type: none"> An operation instruction was executed for an axis or an axes group that was in a coordinated multi-axes motion. A robot instruction that you cannot use for an axes group in a Group-Enable state was executed. 	<ul style="list-style-type: none"> An operation instruction was executed for an axis or an axes group that was in a coordinated multi-axes motion. The MC_SetKinTransform instruction was executed for an axes group in a GroupEnable state. 				○		page 3-340
5401543F hex	Multi-axes Coordinated Control Instruction Executed for Disabled Axes Group	A multi-axes coordinated control instruction was executed for an axes group that was in a GroupDisable state.	<ul style="list-style-type: none"> A multi-axes coordinated control instruction was executed for an axes group that was in a GroupDisable state. One of the following instructions was executed for an axes group that was in a GroupDisable state. MC_MoveTimeAbsolute MC_SyncLinearConveyor MC_SyncOut MC_RobotJog 				○		page 3-341
54015440 hex	Axes Group Cannot Be Enabled	Execution of the MC_GroupEnable (Enable Axes Group) instruction failed.	<ul style="list-style-type: none"> When the MC_GroupEnable (Enable Axes Group) instruction was executed, there was a composition axis that was not stopped. When the MC_GroupEnable (Enable Axes Group) instruction was executed, there was a composition axis for which the MC_TouchProbe (Enable External Latch) instruction was being executed. 				○		page 3-342
54015441 hex	Impossible Axis Operation Specified when the Servo is OFF	An operation instruction was executed for an axis for which the Servo is OFF.	<ul style="list-style-type: none"> An operation instruction was executed for an axis for which the Servo is OFF. Home was preset with the MC_Home or MC_HomeWithParameter instruction for an axis for which EtherCAT process data communications are not established. 				○		page 3-343

Event code	Event name	Meaning	Assumed cause	Level					Reference
				M a j	P r t	M i n	O b s	I n f o	
54015442 hex	Composition Axis Stopped Error	A motion instruction was executed for an axes group while the MC_Stop instruction was being executed for a composition axis.	<ul style="list-style-type: none"> A motion instruction was executed for an axes group while the MC_Stop instruction was being executed for a composition axis. 				○		page 3-344
54015443 hex	Motion Control Instruction Multi-execution Buffer Limit Exceeded	The number of motion control instructions that is buffered for Buffered or Blending Buffer Modes exceeded the buffer limit.	<ul style="list-style-type: none"> An axis instruction was executed when there was already a current instruction and a buffered instruction for the same axis. An axes group instruction was executed when there was already eight current instructions and buffered instructions for the same axis. 				○		page 3-344
54015444 hex	Insufficient Travel Distance	The specified motion cannot be executed for the deceleration rate or acceleration rate that was specified for multi-execution or re-execution of a positioning instruction.	<ul style="list-style-type: none"> Stopping at the target position was not possible for the specified acceleration/deceleration rate for multi-execution or re-execution of a positioning instruction when the Acceleration/Deceleration Over parameter was set to generate a minor fault and stop. 				○		page 3-345
54015445 hex	Insufficient Travel Distance to Achieve Blending Transit Velocity	There is not sufficient travel distance to accelerate or decelerate to the transit velocity.	<ul style="list-style-type: none"> There was not sufficient travel distance to accelerate the current command to the transit velocity when the Acceleration/Deceleration Over parameter was set to generate a minor fault and stop. 				○		page 3-346
54015446 hex	Move Link Constant Velocity Insufficient Travel Distance	The constant-velocity travel distance of the master axis is less than zero.	<ul style="list-style-type: none"> The constant velocity travel distance of the master axis is below 0 for the MC_MoveLink (Synchronous Positioning) instruction. 				○		page 3-346
54015447 hex	Positioning Gear Operation Insufficient Target Velocity	For the MC_GearInPos (Positioning Gear Operation) or MC_GearInPos2 (Positioning Gear Operation2) instruction, the <i>target velocity</i> of the slave axis is too small to achieve the required velocity.	<ul style="list-style-type: none"> For the MC_GearInPos (Positioning Gear Operation) or MC_GearInPos2 (Positioning Gear Operation2) instruction, the value of the <i>Velocity (Target Velocity)</i> input variable is smaller than the master axis velocity multiplied by the gear ratio when the instruction was executed. 				○		page 3-347

Event code	Event name	Meaning	Assumed cause	Level					Reference
				M a j	P r t	M i n	O b s	I n f o	
54015448 hex	Same Start Point and End Point for Circular Interpolation	The start point and end point were the same when the radius method was specified for the MC_MoveCircular2D (Circular 2D Interpolation) instruction. Or, the start point, end point, and border point were the same when the border point method was specified.	<ul style="list-style-type: none"> The start point and end point were the same when the radius method was specified for the MC_MoveCircular2D (Circular 2D Interpolation) instruction. The start point, end point, and border point were the same when the border point method was specified for the MC_MoveCircular2D (Circular 2D Interpolation) instruction. 				○		page 3-348
54015449 hex	Circular Interpolation Center Specification Position Out of Range	The position specified for the center point exceeded the allowed range when the center method was specified for the MC_MoveCircular2D (Circular 2D Interpolation) instruction.	<ul style="list-style-type: none"> The difference between the distance from the start point to the center point and the distance between the end point to the center point exceeded the permitted value specified for the correction allowance ratio in the axes group settings when the center designation method was specified for the MC_MoveCircular2D (Circular 2D Interpolation) instruction. 				○		page 3-349
5401544A hex	Instruction Execution Error Caused by Count Mode Setting	An instruction that cannot be used when the Count Mode is set to Rotary Mode was executed for an axis that was set to Rotary Mode.	<ul style="list-style-type: none"> An instruction that cannot be used when the Count Mode is set to Rotary Mode was executed for an axis that was set to Rotary Mode. 				○		page 3-349
5401544C hex	Parameter Selection Out of Range	The parameter specified for the <i>ParameterNumber</i> input variable to a motion control instruction is out of range.	<ul style="list-style-type: none"> Instruction input parameter exceeded the valid range of the input variable. 				○		page 3-350
5401544D hex	Stop Method Selection Out of Range	The parameter specified for the <i>StopMode</i> input variable to a motion control instruction is out of range.	<ul style="list-style-type: none"> Instruction input parameter exceeded the valid range of the input variable. 				○		page 3-350

Event code	Event name	Meaning	Assumed cause	Level					Reference
				M a j	P r t	M i n	O b s	I n f o	
5401544E hex	Latch ID Selection Out of Range for Trigger Input Condition	The parameter specified for the <i>TriggerInput::LatchID</i> input variable to a motion control instruction is out of range.	<ul style="list-style-type: none"> Instruction input parameter exceeded the valid range of the input variable. 				○		page 3-351
5401544F hex	Setting Out of Range for Writing MC Setting	The parameter specified for the <i>SettingValue</i> input variable to a motion control instruction is out of range.	<ul style="list-style-type: none"> Instruction input parameter exceeded the valid range of the input variable. The parameter specification and the data type of the setting value do not agree. 				○		page 3-351
54015450 hex	Trigger Input Condition Mode Selection Out of Range	The parameter specified for the <i>TriggerInput::Mode</i> input variable to a motion control instruction is out of range.	<ul style="list-style-type: none"> Instruction input parameter exceeded the valid range of the input variable. 				○		page 3-352
54015451 hex	Drive Trigger Signal Selection Out of Range for Trigger Input Condition	The parameter specified for the <i>TriggerInput::InputDrive</i> input variable to a motion control instruction is out of range.	<ul style="list-style-type: none"> Instruction input parameter exceeded the valid range of the input variable. 				○		page 3-352
54015453 hex	Motion Control Instruction Re-execution Disabled (Axis Specification)	An attempt was made to change the parameter for the <i>Axis</i> input variable when re-executing a motion control instruction. (This input variable cannot be changed when re-executing an instruction.)	<ul style="list-style-type: none"> A parameter for an input variable that cannot be changed for re-execution was changed. 				○		page 3-353
54015454 hex	Motion Control Instruction Re-execution Disabled (Buffer Mode Selection)	An attempt was made to change the parameter for the <i>BufferMode</i> input variable when re-executing a motion control instruction. (This input variable cannot be changed when re-executing an instruction.)	<ul style="list-style-type: none"> A parameter for an input variable that cannot be changed for re-execution was changed. 				○		page 3-354

Event code	Event name	Meaning	Assumed cause	Level					Reference
				M a j	P r t	M i n	O b s	I n f o	
54015455 hex	Motion Control Instruction Re-execution Disabled (Direction Selection)	An attempt was made to change the parameter for the <i>Direction</i> input variable when re-executing a motion control instruction. (This input variable cannot be changed when re-executing an instruction.)	<ul style="list-style-type: none"> An input variable that cannot be changed for re-execution was changed. 				○		page 3-355
54015456 hex	Motion Control Instruction Re-execution Disabled (Execution Mode)	An attempt was made to change the parameter for the <i>Periodic</i> input variable when re-executing a motion control instruction. (This input variable cannot be changed when re-executing an instruction.)	<ul style="list-style-type: none"> A parameter for an input variable that cannot be changed for re-execution was changed. 				○		page 3-355
54015457 hex	Motion Control Instruction Re-execution Disabled (Axes Group Specification)	An attempt was made to change the parameter for the <i>AxesGroup</i> input variable when re-executing a motion control instruction. (This input variable cannot be changed when re-executing an instruction.)	<ul style="list-style-type: none"> A parameter for an input variable that cannot be changed for re-execution was changed. 				○		page 3-356
54015458 hex	Motion Control Instruction Re-execution Disabled (Jerk Setting)	An attempt was made to change the parameter for the <i>Jerk</i> input variable when re-executing a motion control instruction. (This input variable cannot be changed when re-executing an instruction.)	<ul style="list-style-type: none"> A parameter for an input variable that cannot be changed for re-execution was changed. 				○		page 3-357
54015459 hex	Motion Control Instruction Re-execution Disabled (Master Axis)	An attempt was made to change the parameter for the <i>Master</i> input variable when re-executing a motion control instruction. (This input variable cannot be changed when re-executing an instruction.)	<ul style="list-style-type: none"> A parameter for an input variable that cannot be changed for re-execution was changed. 				○		page 3-358

Event code	Event name	Meaning	Assumed cause	Level					Reference
				M a j	P r t	M i n	O b s	I n f o	
5401545A hex	Motion Control Instruction Re-execution Disabled (MasterOffset)	An attempt was made to change the parameter for the <i>MasterOffset</i> input variable when re-executing a motion control instruction. (This input variable cannot be changed when re-executing an instruction.)	<ul style="list-style-type: none"> A parameter for an input variable that cannot be changed for re-execution was changed. 				○		page 3-358
5401545B hex	Motion Control Instruction Re-execution Disabled (MasterScaling)	An attempt was made to change the parameter for the <i>MasterScaling</i> input variable when re-executing a motion control instruction. (This input variable cannot be changed when re-executing an instruction.)	<ul style="list-style-type: none"> A parameter for an input variable that cannot be changed for re-execution was changed. 				○		page 3-359
5401545C hex	Motion Control Instruction Re-execution Disabled (MasterStartDistance)	An attempt was made to change the parameter for the <i>MasterStartDistance</i> input variable when re-executing a motion control instruction. (This input variable cannot be changed when re-executing an instruction.)	<ul style="list-style-type: none"> A parameter for an input variable that cannot be changed for re-execution was changed. 				○		page 3-359
5401545D hex	Motion Control Instruction Re-execution Disabled (Continuous)	An attempt was made to change the parameter for the <i>Continuous</i> input variable when re-executing a motion control instruction. (This input variable cannot be changed when re-executing an instruction.)	<ul style="list-style-type: none"> A parameter for an input variable that cannot be changed for re-execution was changed. 				○		page 3-360

Event code	Event name	Meaning	Assumed cause	Level					Reference
				M a j	P r t	M i n	O b s	I n f o	
5401545E hex	Motion Control Instruction Re-execution Disabled (Move-Mode)	An attempt was made to change the parameter for the <i>MoveMode</i> input variable when re-executing a motion control instruction. (This input variable cannot be changed when re-executing an instruction.)	<ul style="list-style-type: none"> A parameter for an input variable that cannot be changed for re-execution was changed. 				○		page 3-360
5401545F hex	Illegal Auxiliary Axis Specification	The axis specified for the <i>Auxiliary</i> input variable to a motion control instruction does not exist.	<ul style="list-style-type: none"> An axis does not exist for the variable specified for the <i>Auxiliary</i> input variable to the instruction. 				○		page 3-361
54015460 hex	Illegal Axis Specification	The axis specified for the <i>Axis</i> input variable to a motion control instruction does not exist.	<ul style="list-style-type: none"> An axis does not exist for the variable specified for the <i>Axis</i> input variable to the instruction. 				○		page 3-361
54015461 hex	Illegal Axes Group Specification	The axes group specified for the <i>AxesGroup</i> input variable to a motion control instruction does not exist or is not a used group.	<ul style="list-style-type: none"> An axes group does not exist for the variable specified for the <i>AxesGroup</i> input variable to the instruction. The axes group specified for the <i>AxesGroup</i> input variable to the instruction is not specified as a used group. 				○		page 3-362
54015462 hex	Illegal Master Axis Specification	The axis that is specified for the <i>Master</i> input variable to a motion control instruction is not correct.	<ul style="list-style-type: none"> An axis does not exist for the variable specified for the <i>Master</i> input variable to the instruction. The axis that was specified for the <i>Master</i> input variable to the MC_Phasing (Shift Master Axis Phase) instruction is not the master axis for syncing. The master axis and a slave axis are not assigned to the same task. 				○		page 3-363
54015463 hex	Motion Control Instruction Re-execution Disabled (Slave-Offset)	An attempt was made to change the <i>SlaveOffset</i> input variable when re-executing a motion control instruction. (This input variable cannot be changed when re-executing an instruction.)	<ul style="list-style-type: none"> A parameter for an input variable that cannot be changed for re-execution was changed. 				○		page 3-364

Event code	Event name	Meaning	Assumed cause	Level					Reference
				M a j	P r t	M i n	O b s	I n f o	
54015464 hex	Motion Control Instruction Re-execution Disabled (Slave-Scaling)	An attempt was made to change the <i>SlaveScaling</i> input variable when re-executing a motion control instruction. (This input variable cannot be changed when re-executing an instruction.)	<ul style="list-style-type: none"> A parameter for an input variable that cannot be changed for re-execution was changed. 				○		page 3-364
54015465 hex	Motion Control Instruction Re-execution Disabled (Start-Position)	An attempt was made to change the <i>StartPosition</i> input variable when re-executing a motion control instruction. (This input variable cannot be changed when re-executing an instruction.)	<ul style="list-style-type: none"> A parameter for an input variable that cannot be changed for re-execution was changed. 				○		page 3-365
54015466 hex	Instruction Execution Error with Undefined Home	High-speed homing or an interpolation instruction was executed when home was undefined.	<ul style="list-style-type: none"> High-speed homing was executed when home was undefined. An interpolation instruction was executed for an axes group that includes an axis with no defined home. One of the following robot instructions was executed for an axes group that includes a logical axis with no defined home. MC_SetKinTransform MC_MoveTimeAbsolute MC_SyncLinearConveyor MC_SyncOut MC_GroupMon MC_RobotJog 				○		page 3-366
54015467 hex	Motion Control Instruction Re-execution Disabled (Position Type)	An attempt was made to change the <i>ReferenceType</i> input variable when re-executing a motion control instruction. (This input variable cannot be changed when re-executing an instruction.)	<ul style="list-style-type: none"> A parameter for an input variable that cannot be changed for re-execution was changed. 				○		page 3-367
54015468 hex	Unused Axis Specification for Master Axis	The master axis specified for a motion control instruction is an unused axis.	<ul style="list-style-type: none"> The master axis specified for a motion control instruction is an unused axis. 				○		page 3-367

Event code	Event name	Meaning	Assumed cause	Level					Reference
				M a j	P r t	M i n	O b s	I n f o	
54015469 hex	First Position Setting Out of Range	The parameter specified for the <i>FirstPosition</i> input variable to a motion control instruction is out of range.	<ul style="list-style-type: none"> Instruction input parameter exceeded the valid range of the input variable. 				○		page 3-368
5401546A hex	Last Position Setting Out of Range	The parameter specified for the <i>LastPosition</i> input variable to a motion control instruction is out of range.	<ul style="list-style-type: none"> Instruction input parameter exceeded the valid range of the input variable. 				○		page 3-368
5401546B hex	Illegal First/ Last Position Size Relationship (Linear Mode)	The parameter specified for the <i>LastPosition</i> input variable to a motion control instruction is smaller than the parameter specified for the <i>FirstPosition</i> input variable.	<ul style="list-style-type: none"> The value of the <i>LastPosition</i> input parameter is less than the value of the <i>FirstPosition</i> input variable for the instruction when the Count Mode is set to Linear Mode. 				○		page 3-369
5401546C hex	Master Sync Start Position Setting Out of Range	The parameter specified for the <i>MasterSyncPosition</i> input variable to a motion control instruction is out of range.	<ul style="list-style-type: none"> Instruction input parameter exceeded the valid range of the input variable. 				○		page 3-369
5401546D hex	Slave Sync Start Position Setting Out of Range	The parameter specified for the <i>SlaveSyncPosition</i> input variable to a motion control instruction is out of range.	<ul style="list-style-type: none"> Instruction input parameter exceeded the valid range of the input variable. 				○		page 3-370
5401546E hex	Duplicate Latch ID for Trigger Input Condition	The same latch ID was specified for more than one motion control instruction.	<ul style="list-style-type: none"> The same latch ID is used simultaneously for more than one of the following instructions: MC_TouchProbe (Enable External Latch) instruction, MC_MoveLink (Synchronous Positioning) instruction, and MC_MoveFeed (Interrupt Feeding) instruction. The MC_AbortTrigger (Disable External Latch) instruction was executed to cancel a latch that was used by an instruction other than the MC_TouchProbe (Enable External Latch) instruction. 				○		page 3-370

Event code	Event name	Meaning	Assumed cause	Level					Reference
				M a j	P r t	M i n	O b s	I n f o	
5401546F hex	Jerk Over- ride Factor Out of Range	The parameter speci- fied for the <i>JerkFactor</i> input variable to a motion control in- struction is out of range.	<ul style="list-style-type: none"> Instruction input parameter ex- ceeded the valid range of the input variable. 				○		page 3-371
54015470 hex	Acceleration/ Deceleration Override Factor Out of Range	The parameter speci- fied for the <i>AccFactor</i> input variable to a motion control in- struction is out of range.	<ul style="list-style-type: none"> Instruction input parameter ex- ceeded the valid range of the input variable. 				○		page 3-371
54015471 hex	First Position Method Specification Out of Range	The parameter speci- fied for the <i>StartMode</i> input variable to a motion control in- struction is out of range.	<ul style="list-style-type: none"> Instruction input parameter ex- ceeded the valid range of the input variable. 				○		page 3-372
54015472 hex	Motion Con- trol Instruc- tion Re-exe- cution Disa- bled (First Position Method)	An attempt was made to change the <i>StartMode</i> input vari- able when re-execut- ing a motion control instruction. (This in- put variable cannot be changed when re- executing an instruc- tion.)	<ul style="list-style-type: none"> A parameter for an input varia- ble that cannot be changed for re-execution was changed. 				○		page 3-372
54015474 hex	Unused Axis Specification for Auxiliary Axis	The axis specified for the <i>Auxiliary</i> input variable to a motion control instruction is an unused axis.	<ul style="list-style-type: none"> The axis specified for the <i>Auxiliary</i> input variable to the instruction is an unused axis. 				○		page 3-373
54015475 hex	Position Gear Value Error	Synchronized motion is not possible for the velocity, acceleration rate, and deceleration rate that were input to a motion control in- struction.	<ul style="list-style-type: none"> The specified synchronized motion cannot be performed at the velocity, acceleration rate, or deceleration rate that is in- put to the instruction. 				○		page 3-373
54015476 hex	Position Gear Master Axis Zero Velocity	The velocity of the master axis was zero when a motion con- trol instruction was started.	<ul style="list-style-type: none"> The velocity of the master axis was 0 when the instruction was started. 				○		page 3-374
54015478 hex	Target Posi- tion Setting Out of Range	The parameter speci- fied for the <i>Position</i> input variable to a motion control in- struction is out of range.	<ul style="list-style-type: none"> Instruction input parameter ex- ceeded the valid range of the input variable. The target position of a Rotary Mode axis is not within the ring setting range. 				○		page 3-374

Event code	Event name	Meaning	Assumed cause	Level					Reference
				M a j	P r t	M i n	O b s	I n f o	
54015479 hex	Travel Distance Out of Range	The parameter that was specified for the <i>Distance</i> input variable to a motion control instruction is out of range or the target position with the value of <i>Distance</i> added is out of range.	<ul style="list-style-type: none"> The absolute value of the instruction input parameter exceeded the range of 40-bit data when it is converted to pulses. For a Linear Mode axis, the target position with the travel distance added exceeded signed 40-bit data when the absolute value is converted to pulses. 				○		page 3-375
5401547A hex	Cam Table Start Point Setting Out of Range	The parameter specified for the <i>StartPosition</i> input variable to a motion control instruction is out of range.	<ul style="list-style-type: none"> Instruction input parameter exceeded the valid range of the input variable. 				○		page 3-375
5401547B hex	Cam Master Axis Following First Position Setting Out of Range	The parameter specified for the <i>MasterStartDistance</i> input variable to a motion control instruction is out of range.	<ul style="list-style-type: none"> Instruction input parameter exceeded the valid range of the input variable. 				○		page 3-376
5401547C hex	Circular Interpolation Radius Setting Error	It was not possible to create a circular path for the specified radius when the radius method was specified for the MC_MoveCircular2D (Circular 2D Interpolation) instruction.	<ul style="list-style-type: none"> For the MC_MoveCircular2D (Circular 2D Interpolation) instruction, it was not possible to create a circular path for the specified radius when the radius method was specified for circular interpolation. 				○		page 3-376
5401547D hex	Circular Interpolation Radius Overflow	For the MC_MoveCircular2D (Circular 2D Interpolation) instruction, the radius of the circle exceeded the maximum value for the border point or center specification method.	<ul style="list-style-type: none"> For the MC_MoveCircular2D (Circular 2D Interpolation) instruction, the radius of the circle exceeded 40-bit data when converted to pulses for the border point or center specification method. 				○		page 3-377
5401547E hex	Circular Interpolation Setting Out of Range	The parameter specified for the <i>CircAxes</i> input variable to a motion control instruction is out of range.	<ul style="list-style-type: none"> Instruction input parameter exceeded the valid range of the input variable. The axes that were specified in <i>CircAxes</i> are not included in the composition axes in the Axes Group Settings. The same axis was specified for both axes of <i>CircAxes</i>. 				○		page 3-378

Event code	Event name	Meaning	Assumed cause	Level					Reference
				M a j	P r t	M i n	O b s	I n f o	
5401547F hex	Auxiliary/ Slave Axis Numbers Not in As- cending Or- der	The values of the pa- rameters for the <i>Auxiliary</i> and <i>Slave</i> input variables to a motion control in- struction are not in ascending order.	<ul style="list-style-type: none"> The parameters for the <i>Auxiliary</i> and <i>Slave</i> input variables to the instruction are not in ascending order. 				○		page 3-378
54015480 hex	Cam Table Property As- cending Da- ta Error at Update	A phase that was not in ascending order was found during cal- culating the number of valid data. Or, after calculations, the num- ber of valid data is 0.	<ul style="list-style-type: none"> A phase that was not in as- cending order was found when calculating the number of valid data. After calculations, the number of valid data is 0. 				○		page 3-379
54015481 hex	MC_Write Target Out of Range	The parameter speci- fied for the <i>Target</i> in- put variable to a mo- tion control instruction is out of range.	<ul style="list-style-type: none"> Instruction input parameter ex- ceeded the valid range of the input variable. 				○		page 3-379
54015482 hex	Master Trav- el Distance Specification Out of Range	The parameter speci- fied for the <i>MasterDistance</i> input variable to a motion control instruction is out of range.	<ul style="list-style-type: none"> Instruction input parameter ex- ceeded the valid range of the input variable. 				○		page 3-380
54015483 hex	Master Dis- tance in Ac- celeration Specification Out of Range	The parameter speci- fied for the <i>MasterDistanceACC</i> input variable to a motion control in- struction is out of range.	<ul style="list-style-type: none"> Instruction input parameter ex- ceeded the valid range of the input variable. 				○		page 3-380
54015484 hex	Master Dis- tance in De- celeration Specification Out of Range	The parameter speci- fied for the <i>MasterDistanceDEC</i> input variable to a motion control in- struction is out of range.	<ul style="list-style-type: none"> Instruction input parameter ex- ceeded the valid range of the input variable. 				○		page 3-381
54015487 hex	Execution Mode Selec- tion Out of Range	The parameter speci- fied for the <i>ExecutionMode</i> input variable to a motion control instruction is out of range.	<ul style="list-style-type: none"> Instruction input parameter ex- ceeded the valid range of the input variable. 				○		page 3-381
54015488 hex	Permitted Following Error Out of Range	The parameter speci- fied for the <i>PermittedDeviation</i> input variable to a motion control in- struction is out of range.	<ul style="list-style-type: none"> Instruction input parameter ex- ceeded the valid range of the input variable. 				○		page 3-382

Event code	Event name	Meaning	Assumed cause	Level					Reference
				M a j	P r t	M i n	O b s	I n f o	
54015489 hex	Border Point/Center Position/ Radius Specification Out of Range	The parameter specified for the <i>AuxPoint</i> input variable to a motion control instruction is out of range.	<ul style="list-style-type: none"> The value of <i>AuxPoint</i> exceeded signed 40-bit data when converted to pulses for the border point or center specification method. For a radius specifications, the absolute value of <i>AuxPoint[0]</i> exceeded 40-bit data when converted to pulses. 				○		page 3-382
5401548A hex	End Point Specification Out of Range	The parameter specified for the <i>EndPoint</i> input variable to a motion control instruction is out of range.	<ul style="list-style-type: none"> The instruction input parameter exceeded the range of signed 40-bit data when it was converted to pulses. 				○		page 3-383
5401548B hex	Slave Travel Distance Specification Out of Range	The parameter specified for the <i>SlaveDistance</i> input variable to a motion control instruction is out of range.	<ul style="list-style-type: none"> The instruction input parameter exceeded the range of 40-bit data when it is converted to pulses. 				○		page 3-383
5401548C hex	Phase Shift Amount Out of Range	The parameter specified for the <i>PhaseShift</i> input variable to a motion control instruction is out of range.	<ul style="list-style-type: none"> The absolute value of the instruction input parameter exceeded the range of 40-bit data when it is converted to pulses. 				○		page 3-384
5401548D hex	Feeding Distance Out of Range	The parameter specified for the <i>FeedDistance</i> input variable to a motion control instruction is out of range.	<ul style="list-style-type: none"> The absolute value of the instruction input parameter exceeded the range of 40-bit data when it is converted to pulses. 				○		page 3-384
5401548E hex	Auxiliary and Slave Defined as Same Axis	The same axis was specified for the <i>Auxiliary</i> and <i>Slave</i> input variables to a motion control instruction.	<ul style="list-style-type: none"> The parameter is the same for the <i>Auxiliary</i> and <i>Slave</i> input variables to the instruction. 				○		page 3-385
5401548F hex	Relative Position Selection Out of Range	The parameter specified for the <i>Relative</i> input variable to a motion control instruction is out of range.	<ul style="list-style-type: none"> Instruction input parameter exceeded the valid range of the input variable. 				○		page 3-385
54015490 hex	Cam Transition Specification Out of Range	The parameter specified for the <i>CamTransition</i> input variable to a motion control instruction is out of range.	<ul style="list-style-type: none"> Instruction input parameter exceeded the valid range of the input variable. 				○		page 3-386

Event code	Event name	Meaning	Assumed cause	Level					Reference
				M a j	P r t	M i n	O b s	I n f o	
54015491 hex	Synchron-ized Control End Mode Selection Out of Range	The parameter specified for the <i>OutMode</i> input variable to a motion control instruction is out of range.	<ul style="list-style-type: none"> Instruction input parameter exceeded the valid range of the input variable. 				○		page 3-386
54015492 hex	Enable External Latch Instruction Execution Disabled	<i>_mclImmediateStop</i> was specified for the <i>StopMode</i> input variable when the <i>MC_TouchProbe</i> (Enable External Latch) instruction was executed in Drive Mode for an encoder axis.	<ul style="list-style-type: none"> <i>_mclImmediateStop</i> was specified for the <i>StopMode</i> input variable when the <i>MC_TouchProbe</i> (Enable External Latch) instruction was executed in Drive Mode for an encoder axis. 				○		page 3-387
54015493 hex	Master Axis Offset Out of Range	The parameter specified for the <i>MasterOffset</i> input variable to a motion control instruction is out of range.	<ul style="list-style-type: none"> The instruction input parameter exceeded the range of signed 40-bit data when it was converted to pulses. 				○		page 3-387
54015494 hex	Slave Axis Offset Out of Range	The parameter specified for the <i>SlaveOffset</i> input variable to a motion control instruction is out of range.	<ul style="list-style-type: none"> The instruction input parameter exceeded the range of signed 40-bit data when it was converted to pulses. 				○		page 3-388
54015495 hex	Command Current Position Count Selection Out of Range	The parameter specified for the <i>CmdPosMode</i> input variable to a motion control instruction is out of range.	<ul style="list-style-type: none"> Instruction input parameter exceeded the valid range of the input variable. 				○		page 3-388
54015496 hex	Master Axis Gear Ratio Numerator Out of Range	The parameter specified for the <i>RatioNumeratorMaster</i> input variable to a motion control instruction is out of range.	<ul style="list-style-type: none"> Instruction input parameter exceeded the valid range of the input variable. 				○		page 3-389
54015497 hex	Master Axis Gear Ratio Denominator Out of Range	The parameter specified for the <i>RatioDenominatorMaster</i> input variable to a motion control instruction is out of range.	<ul style="list-style-type: none"> Instruction input parameter exceeded the valid range of the input variable. 				○		page 3-389

Event code	Event name	Meaning	Assumed cause	Level					Reference
				M a j	P r t	M i n	O b s	I n f o	
54015498 hex	Auxiliary Axis Gear Ratio Numerator Out of Range	The parameter specified for the <i>RatioNumeratorAuxiliary</i> input variable to a motion control instruction is out of range.	<ul style="list-style-type: none"> Instruction input parameter exceeded the valid range of the input variable. 				○		page 3-390
54015499 hex	Auxiliary Axis Gear Ratio Denominator Out of Range	The parameter specified for the <i>RatioDenominatorAuxiliary</i> input variable to a motion control instruction is out of range.	<ul style="list-style-type: none"> Instruction input parameter exceeded the valid range of the input variable. 				○		page 3-390
5401549A hex	Master Axis Position Type Selection Out of Range	The parameter specified for the <i>ReferenceTypeMaster</i> input variable to a motion control instruction is out of range.	<ul style="list-style-type: none"> Instruction input parameter exceeded the valid range of the input variable. 				○		page 3-391
5401549B hex	Auxiliary Axis Position Type Selection Out of Range	The parameter specified for the <i>ReferenceTypeAuxiliary</i> input variable to a motion control instruction is out of range.	<ul style="list-style-type: none"> Instruction input parameter exceeded the valid range of the input variable. 				○		page 3-391
5401549C hex	Target Position Ring Counter Out of Range	Operation is not possible because the target position is out of range for the ring counter of the executed instruction.	<ul style="list-style-type: none"> High-speed homing was executed when 0 was not included in the ring counter. 				○		page 3-392
5401549D hex (Ver. 1.01 or later)	Axes Group Composition Axis Setting Out of Range	The parameter specified for the <i>Axes</i> input variable to a motion control instruction is out of range.	<ul style="list-style-type: none"> Instruction input parameter exceeded the valid range of the input variable. The composition axes in the axes group are not assigned to the same task. 				○		page 3-392
5401549E hex (Version 1.04 or later)	Axis Use Setting Out of Range	The parameter specified for the <i>AxisUse</i> input variable to a motion control instruction is out of range.	<ul style="list-style-type: none"> Instruction input parameter exceeded the valid range of the input variable. 				○		page 3-393
54015700 hex (Ver. 1.03 or later)	Homing Parameter Setting Out of Range	The parameter specified for the <i>HomingParameter</i> input variable to a motion control instruction is out of range.	<ul style="list-style-type: none"> Instruction input parameter exceeded the valid range of the input variable. 				○		page 3-393

Event code	Event name	Meaning	Assumed cause	Level					Reference
				M a j	P r t	M i n	O b s	I n f o	
54015702 hex (Version 1.04 or later)	Axis Use Change Error	The MC_ChangeAxisUse (Change Axis Use) instruction was executed when the axis was not stopped or when the command velocity of the axis was saturated.	<ul style="list-style-type: none"> The MC_ChangeAxisUse (Change Axis Use) instruction was executed when the axis was not stopped or when the command velocity of the axis was saturated. 				○		page 3-394
54015703 hex (Ver. 1.06 or later)	Cannot Change Axis Use	The MC_ChangeAxisUse (Change Axis Use) instruction was executed in a way that would cause the maximum number of used real axes or the maximum number of used motion control servo axes to be exceeded.	<ul style="list-style-type: none"> The MC_ChangeAxisUse (Change Axis Use) instruction was executed in a way that would cause the maximum number of used real axes to be exceeded. The MC_ChangeAxisUse (Change Axis Use) instruction was executed in a way that would cause the maximum number of used motion control servo axes to be exceeded. 				○		page 3-395
54015720 hex (Version 1.04 or later)	Motion Control Parameter Setting Error When Changing Axis Use	The motion control parameter settings for the axis that was changed to a used axis are incorrect.	<ul style="list-style-type: none"> The MC_ChangeAxisUse (Change Axis Use) instruction was used to change an unused axis to a used axis, but the motion control parameter settings of the axis are not correct. The power supply was interrupted while a download of the motion control parameter settings was in progress. The non-volatile memory is faulty or the life of the non-volatile memory has been exceeded. 				○		page 3-396

Event code	Event name	Meaning	Assumed cause	Level					Reference
				M a j	P r t	M i n	O b s	I n f o	
54015721 hex (Version 1.04 or later)	Required Process Data Object Not Set When Changing Axis Use	The objects that are required for the axis type of the axis that was changed to a used axis are not set.	<ul style="list-style-type: none"> The objects that are required for the axis type of the axis that was changed to a used axis are not set in the PDO map settings. The power supply was interrupted while a download of the motion control parameter settings was in progress. The non-volatile memory is faulty or the life of the non-volatile memory has been exceeded. The MC_ChangeAxisUse (Change Axis Use) instruction was executed for an axis that is set to Unused axis (unchangeable to used axis). 				○		page 3-397
54015722 hex (Ver. 1.06 or later)	Actual Position Overflow/Underflow	An instruction was executed that is not supported during an actual position overflow/underflow.	<ul style="list-style-type: none"> An instruction was executed that is not supported during an actual position overflow or underflow. 				○		page 3-398
54015723 hex (Ver. 1.06 or later)	Switch Structure Track Number Setting Out of Range	The value of <i>TrackNumber</i> that is specified in the <i>Switches</i> in-out variable to a motion control instruction is out of range.	<ul style="list-style-type: none"> The value of the member of the structure variable that was specified for the in-out variable of the instruction is out of range. 				○		page 3-398
54015724 hex (Ver. 1.06 or later)	Switch Structure First ON Position Setting Out of Range	The value of <i>FirstOnPosition</i> that is specified in the <i>Switches</i> in-out variable to a motion control instruction is out of range.	<ul style="list-style-type: none"> The value of the member of the structure variable that was specified for the in-out variable of the instruction is out of range. 				○		page 3-399
54015725 hex (Ver. 1.06 or later)	Switch Structure Last ON Position Setting Out of Range	The value of <i>LastOnPosition</i> that is specified in the <i>Switches</i> in-out variable to a motion control instruction is out of range.	<ul style="list-style-type: none"> The value of the member of the structure variable that was specified for the in-out variable of the instruction is out of range. 				○		page 3-399
54015726 hex (Ver. 1.06 or later)	Switch Structure Axis Direction Out of Range	The value of <i>AxisDirection</i> that is specified in the <i>Switches</i> in-out variable to a motion control instruction is out of range.	<ul style="list-style-type: none"> The value of the member of the structure variable that was specified for the in-out variable of the instruction is out of range. 				○		page 3-400

Event code	Event name	Meaning	Assumed cause	Level					Reference
				M a j	P r t	M i n	O b s	I n f o	
54015727 hex (Ver. 1.06 or later)	Switch Structure Cam Switch Mode Out of Range	The value of <i>CamSwitchMode</i> that is specified in the <i>Switches</i> in-out variable to a motion control instruction is out of range.	<ul style="list-style-type: none"> The value of the member of the structure variable that was specified for the in-out variable of the instruction is out of range. 				○		page 3-400
54015728 hex (Ver. 1.06 or later)	Switch Structure Duration Setting Out of Range	The value of <i>Duration</i> that is specified in the <i>Switches</i> in-out variable to a motion control instruction is out of range.	<ul style="list-style-type: none"> The value of the member of the structure variable that was specified for the in-out variable of the instruction is out of range. 				○		page 3-401
54015729 hex (Ver. 1.06 or later)	Track Option Structure ON Compensation Setting Out of Range	The value of <i>OnCompensation</i> that is specified in the <i>TrackOptions</i> in-out variable to a motion control instruction is out of range.	<ul style="list-style-type: none"> The value of the member of the structure variable that was specified for the in-out variable of the instruction is out of range. 				○		page 3-401
5401572A hex (Ver. 1.06 or later)	Track Option Structure OFF Compensation Setting Out of Range	The value of <i>OffCompensation</i> that is specified in the <i>TrackOptions</i> in-out variable to a motion control instruction is out of range.	<ul style="list-style-type: none"> The value of the member of the structure variable that was specified for the in-out variable of the instruction is out of range. 				○		page 3-402
5401572B hex (Ver. 1.06 or later)	Number of Array Elements in Switch Structure Variable Out of Range	The number of elements in an array in the structure variable that is specified in the <i>Switches</i> in-out variable to a motion control instruction is out of range.	<ul style="list-style-type: none"> The number of elements in an array of the structure variable that was specified for the in-out variable of the instruction is out of range. 				○		page 3-402
5401572C hex (Ver. 1.06 or later)	Number of Array Elements in Output Signal Structure Variable Out of Range	The number of elements in an array in the structure variable that is specified in the <i>Outputs</i> in-out variable to a motion control instruction is out of range.	<ul style="list-style-type: none"> The number of elements in an array of the structure variable that was specified for the in-out variable of the instruction is out of range. 				○		page 3-403
5401572D hex (Ver. 1.06 or later)	Number of Array Elements in Track Option Structure Variable Out of Range	The number of elements in an array in the structure variable that is specified in the <i>TrackOptions</i> in-out variable to a motion control instruction is out of range.	<ul style="list-style-type: none"> The number of elements in an array of the structure variable that was specified for the in-out variable of the instruction is out of range. 				○		page 3-403

Event code	Event name	Meaning	Assumed cause	Level					Reference
				M a j	P r t	M i n	O b s	I n f o	
5401572E hex (Ver. 1.06 or later)	Numbers of Elements in Output Signals and Track Option Arrays Not Matched	The arrays in the structure variables that are specified for the <i>Outputs</i> and <i>Track-Options</i> in-out variables to a motion control instruction do not have the same number of elements.	<ul style="list-style-type: none"> The arrays in the output signal structure variable and track option structure variable that are specified for the in-out variables to the instruction do not have the same number of elements. 				○		page 3-404
5401572F hex (Ver. 1.06 or later)	Motion Control Instruction Multi-execution Disabled (Master Axis)	A <i>Master</i> in-out variable that cannot be changed during multi-execution of instructions was changed.	<ul style="list-style-type: none"> A <i>Master</i> in-out variable that cannot be changed during multi-execution of instructions was changed. 				○		page 3-404
54015730 hex (Ver. 1.06 or later)	Motion Control Instruction Multi-execution Disabled (Position Type Selection)	A <i>ReferenceType</i> in-out variable that cannot be changed during multi-execution of instructions was changed.	<ul style="list-style-type: none"> A <i>ReferenceType</i> in-out variable that cannot be changed during multi-execution of instructions was changed. 				○		page 3-405
54015731 hex (Ver. 1.06 or later)	Same Track Number Setting in Switch Structure Out of Range	The same track number was specified more than the allowable number of times for the <i>TrackNumber</i> in the <i>Switches</i> in-out variable to a motion control instruction.	<ul style="list-style-type: none"> The same track number was specified more than the allowable number of times for the <i>TrackNumber</i> in the <i>Switches</i> in-out variable to a motion control instruction. 				○		page 3-405
5401573A hex (Ver. 1.08 or later)	Cannot Write Axis Parameters	The instruction was executed for an axis that is not an unused axis.	<ul style="list-style-type: none"> The instruction was executed for a used axis or an undefined axis. 				○		page 3-406
5401573B hex (Ver. 1.08 or later)	Axis Parameter Setting Out of Range	The parameter specified for the <i>AxisParameter</i> input variable to a motion control instruction is outside of the valid range.	<ul style="list-style-type: none"> The parameter specified for the <i>AxisParameter</i> input variable to the instruction is out of range for the input variable. 				○		page 3-406
5401573C hex (Ver. 1.08 or later)	Cam Property Setting Out of Range	The parameter specified for the <i>CamProperty</i> input variable to a motion control instruction is outside of the valid range.	<ul style="list-style-type: none"> The parameter specified for the <i>CamProperty</i> input variable to the instruction is out of range for the input variable. 				○		page 3-407

Event code	Event name	Meaning	Assumed cause	Level					Reference
				M a j	P r t	M i n	O b s	I n f o	
5401573D hex (Ver. 1.08 or later)	Cam Node Setting Out of Range	The parameter specified for the <i>CamNodes</i> input variable to a motion control instruction is outside of the valid range.	<ul style="list-style-type: none"> The parameter specified for the <i>CamNodes</i> input variable to the instruction is out of range for the input variable. 				○		page 3-407
5401573E hex (Ver. 1.08 or later)	Incorrect Cam Node Type Specification	The parameter specified for the <i>CamNodes</i> input variable to a motion control instruction is not an <code>_sMC_CAM_NODE</code> array variable.	<ul style="list-style-type: none"> The parameter specified for the <i>CamNodes</i> input variable to the instruction is not an <code>_sMC_CAM_NODE</code> array variable. 				○		page 3-408
5401573F hex (Ver. 1.08 or later)	Insufficient Nodes in Cam Table	The array variable of the parameter specified for the <i>CamNodes</i> input variable to a motion control instruction has a Phase value of 0 for element number 0.	<ul style="list-style-type: none"> The array variable of the parameter specified for the <i>CamNodes</i> input variable to the instruction has a Phase (master axis phase) value of 0 for element number 0. 				○		page 3-408
54015740 hex (Ver. 1.08 or later)	Cam Node Master Axis Phase Not in Ascending Order	The values of Phase in the array variable of the parameter specified for the <i>CamNodes</i> input variable to a motion control instruction are not in ascending order according to the element numbers.	<ul style="list-style-type: none"> The values of Phase (master axis phase) in the array variable of the parameter specified for the <i>CamNodes</i> input variable to the instruction are not in ascending order according to the element numbers. Or, truncating the digits that are not effective more than seven digits caused the phases not to be in ascending order. 				○		page 3-409
54015741 hex (Ver. 1.08 or later)	Too Many Data Points in Cam Table	The number of generated cam data points exceeded the number of elements in the array in the cam data variable that is specified for the <i>CamTable</i> input variable to a motion control instruction.	<ul style="list-style-type: none"> The number of cam data points in the generated cam table exceeded the number of elements in the array in the cam data variable that is specified for the <i>CamTable</i> input variable to the instruction. 				○		page 3-410
54015742 hex (Ver. 1.08 or later)	Cam Table Displacement Overflow	Distance in the generated cam table exceeded the range of REAL data.	<ul style="list-style-type: none"> Distance in the generated cam table exceeded the range of REAL data. 				○		page 3-411

Event code	Event name	Meaning	Assumed cause	Level					Reference
				M a j	P r t	M i n	O b s	I n f o	
54015743 hex (Ver. 1.08 or later)	Aborted Cam Table Used	A cam data variable that was aborted during generation was specified for the <i>CamTable</i> input variable to an instruction.	<ul style="list-style-type: none"> A cam data variable that was aborted during generation due to an error in the MC_GenerateCamTable (Generate Cam Table) instruction was specified for the <i>CamTable</i> input variable to the instruction. 				○		page 3-412
54015749 hex (Ver. 1.10 or later)	Execution ID Setting Out of Range	The parameter specified for the <i>ExecID</i> input variable to a motion control instruction is out of range.	<ul style="list-style-type: none"> The parameter specified for the <i>ExecID</i> input variable to the instruction is out of range for the input variable. 				○		page 3-412
5401574A hex (Ver. 1.10 or later)	Position Off- set Out of Range	The parameter specified for the <i>OffsetPosition</i> input variable to a motion control instruction is out of range.	<ul style="list-style-type: none"> The position offset exceeded the range of signed 40-bit data when it was converted to pulses. 				○		page 3-413
5401574B hex (Ver. 1.10 or later)	PDS State Transition Command Selection Out of Range	The parameter specified for the <i>TransitionCmd</i> input variable to a motion control instruction is out of range.	<ul style="list-style-type: none"> Instruction input parameter exceeded the valid range of the input variable. 				○		page 3-413
5401574C hex (Ver. 1.13 or later)	Single-axis Position Control Axis Motion Control Instruction Execution Disabled	An operation instruction was executed for a single-axis position control axis.	<ul style="list-style-type: none"> An operation instruction was executed for a single-axis position control axis. 				○		page 3-414
54015751 hex (Ver. 1.32 or later) [NX102] (Ver. 1.21 or later) [NX701-□□00, NX1P2, NJ501 (excluding NJ501-□□20), NJ301, NJ101-□□00]	Cam Monitor Mode Selection Out of Range	The cam monitor mode selection specified for the <i>CamMonitorMode</i> input variable to a motion control instruction is out of range.	<ul style="list-style-type: none"> The cam monitor mode selection is out of the valid range. 				○		page 3-414
54015752 hex (Ver. 1.32 or later) [NX102] (Ver. 1.21 or later) [NX701-□□00, NX1P2, NJ501 (excluding NJ501-□□20), NJ301, NJ101-□□00]	Data Type of Cam Monitor Values Mismatch	The data type of the cam monitor values specified for the <i>CamMonitorValue</i> input variable to a motion control instruction does not match the cam monitor mode selection.	<ul style="list-style-type: none"> The data type of the variable specified for the cam monitor values does not match the cam monitor mode selection. 				○		page 3-415

Event code	Event name	Meaning	Assumed cause	Level					Reference
				M a j	P r t	M i n	O b s	I n f o	
54015753 hex (Ver.1.70 or later) [Excluding NX701-□□ □□] (Ver. 1.37 or later) [NX701-□□□□]	Sync Mode Setting Out of Range	The parameter specified for the <i>SyncMode</i> input variable to a motion control instruction is out of range.	<ul style="list-style-type: none"> Instruction input parameter exceeded the valid range of the input variable. 				○		page 3-415
54015754 hex (Ver.1.70 or later) [Excluding NX701-□□ □□] (Ver. 1.37 or later) [NX701-□□□□]	Gear Master Axis Following First Position Setting Out of Range	The parameter specified for the <i>MasterStartDistance</i> input variable to a motion control instruction is out of range.	<ul style="list-style-type: none"> Instruction input parameter exceeded the valid range of the input variable. 				○		page 3-416
54015755 hex (Ver.1.70 or later) [Excluding NX701-□□ □□] (Ver. 1.37 or later) [NX701-□□□□]	Torque Limit Mode Setting Out of Range	The parameter specified for the <i>TorqueLimitMode</i> input variable to a motion control instruction is out of range.	<ul style="list-style-type: none"> Instruction input parameter exceeded the valid range of the input variable. 				○		page 3-416
54015756 hex (Ver.1.70 or later) [Excluding NX701-□□ □□] (Ver. 1.37 or later) [NX701-□□□□]	Insufficient Cam Nodes	The array variable of the parameter specified for the <i>CamNodes</i> input variable to a motion control instruction has a <i>Phase</i> value of 0 for element number 0.	<ul style="list-style-type: none"> The array variable of the parameter specified for <i>CamNodes</i> input variable to the instruction has a <i>Phase</i> (master axis phase) value of 0 for element number 0. 				○		page 3-417
54015757 hex (Ver.1.70 or later) [Excluding NX701-□□ □□] (Ver. 1.37 or later) [NX701-□□□□]	Cam Node Start Point Position Out of Range	The parameter specified for the <i>StartPosition</i> input variable to a motion control instruction is out of range.	<ul style="list-style-type: none"> Instruction input parameter exceeded the valid range of the input variable. 				○		page 3-417
54015758 hex (Ver.1.70 or later) [Excluding NX701-□□ □□] (Ver. 1.37 or later) [NX701-□□□□]	Cam Operation Displacement Overflow	The displacement calculated for the cam operation is out of range.	<ul style="list-style-type: none"> The absolute value of the product of the cam profile curve displacement and the <i>SlaveScaling</i> input variable when it is converted to pulses exceeds the range of 40-bit data. 				○		page 3-418
54015759 hex (Ver.1.70 or later) [Excluding NX701-□□ □□] (Ver. 1.37 or later) [NX701-□□□□]	Reversing Operation Not Possible	When Slave axis reversing not possible is specified in the <i>SyncMode</i> input variable to a motion control instruction, the slave axis has entered an operation pattern causing reversing motion.	<ul style="list-style-type: none"> When Slave axis reversing not possible is specified in the <i>SyncMode</i> input variable, the slave axis has entered an operation causing reversing motion due to the difference in the direction of velocity at the start of catching and during synchronization. 				○		page 3-419

Event code	Event name	Meaning	Assumed cause	Level					Reference
				M a j	P r t	M i n	O b s	I n f o	
54015800 hex [NX502]	X Bus Unit Does Not Exist	The specified Unit does not exist.	<ul style="list-style-type: none"> The specified X Bus Unit does not exist. 				○		page 3-419
54015801 hex [NX502]	Response Timeout	No response was received from the specified Unit.	<ul style="list-style-type: none"> Communications with the specified Unit stopped due to either an X Bus Unit Startup Error, X Bus Unit Communications Error, or X Bus Function Processing Error. The set response monitoring time is too short. 				○		page 3-420
54015C00 hex [NX502]	Cannot Execute at Specified Unit/Port	A tag data link control instruction was executed when execution was not possible. Or, the EtherNet/IP port designated by the specified Unit and port number does not exist.	<ul style="list-style-type: none"> An instruction was executed while the EtherNet/IP port is being restarted or tag data link settings are being downloaded from Network Configurator. The EtherNet/IP port designated by the specified Unit and port number does not exist. 				○		page 3-421
54015C01 hex [NX502]	Too Many Simultaneous Instruction Executions	Tag data link control instructions were executed and the number of instructions exceeded the maximum number that can be executed simultaneously.	<ul style="list-style-type: none"> Two or more tag data link control instructions were executed simultaneously. 				○		page 3-421
54015C03 hex [NX502]	Target Node IP Address Does Not Exist	Connection settings with the target node IP address do not exist on the Ethernet/IP port specified by the specified Unit and port number.	<ul style="list-style-type: none"> Connection settings with the target node IP address do not exist on the Ethernet/IP port specified by the specified Unit and port number. 				○		page 3-422
54015C04 hex [NX502]	Connection Communications Error	Communications cannot be established with the target node specified by target node IP address.	<ul style="list-style-type: none"> Target node is not connected properly. The power supply to the target node is OFF. The Ethernet cable is broken, or loose. Noise 				○		page 3-423
54015C05 hex [NX502]	Connection Setting Error	An abnormal response from the target node was received.	<ul style="list-style-type: none"> Connection settings are incorrect. 				○		page 3-423

Event code	Event name	Meaning	Assumed cause	Level					Reference
				M a j	P r t	M i n	O b s	I n f o	
54016440 hex	Target Position Positive Software Limit Exceeded	The specified position exceeds the positive software limit.	<ul style="list-style-type: none"> The parameter specified for the <i>Position</i> input variable to the instruction is beyond the positive software limit. The first position is beyond the positive software limit and an instruction that specifies motion in the opposite direction of the software limit was executed. The parameter that was specified for the <i>AuxPoint</i> input variable to a border point MC_MoveCircular2D (Circular 2D Interpolation) instruction is beyond the positive software limit. 				○		page 3-424
54016441 hex	Target Position Negative Software Limit Exceeded	The specified position exceeds the negative software limit.	<ul style="list-style-type: none"> The parameter specified for the <i>Position</i> input variable to the instruction is beyond the negative software limit. The first position is beyond the negative software limit and an instruction that specifies motion in the opposite direction of the software limit was executed. The parameter that was specified for the <i>AuxPoint</i> input variable to a border point MC_MoveCircular2D (Circular 2D Interpolation) instruction is beyond the negative software limit. 				○		page 3-425
54016442 hex	Command Position Overflow/Underflow	Positioning, an instruction in the underflow/overflow direction, or an instruction for which the direction is not specified was executed when there was an underflow/overflow in the command position.	<ul style="list-style-type: none"> One of the following was executed when there was a command position overflow/underflow. A positioning instruction A continuous control instruction in the underflow/overflow direction An instruction for which the direction is not specified (syncing or torque control) 				○		page 3-426

Event code	Event name	Meaning	Assumed cause	Level					Reference
				M a j	P r t	M i n	O b s	I n f o	
54016443 hex	Positive Limit Input	An instruction was executed for a motion in the positive direction when the positive limit input was ON.	<ul style="list-style-type: none"> An instruction for a motion in the positive direction was executed when the positive limit input was ON, or an instruction for a motion with no direction specification was executed when the positive limit input was ON. An axes group motion control instruction was executed when the positive limit input was ON. 				○		page 3-427
54016444 hex	Negative Limit Input	An instruction for a motion in the negative direction was executed when the negative limit input was ON.	<ul style="list-style-type: none"> An instruction for a motion in the negative direction was executed when the negative limit input was ON, or an instruction for a motion with no direction specification was executed when the negative limit input was ON. An axes group motion control instruction was executed when the negative limit input was ON. 				○		page 3-428
54017422 hex	Servo Main Circuits OFF	An attempt was made to turn ON the Servo when the main circuit power supply to the Servo Drive was OFF.	<ul style="list-style-type: none"> An attempt was made to turn ON the Servo when the main circuit power supply to the Servo Drive was OFF. 				○		page 3-429

- *1. Assumed cause for the following CPU Units.
- NJ-series, NX102, NX1P2 CPU Unit: Version 1.49 or later
 - NX502 CPU Unit: Version 1.60 or later
 - NX701 CPU Unit: Version 1.29 or later

3-2-2 Error Descriptions

Errors for Self Diagnosis

Event name	DIP Switch Setting Error		Event code	00090000 hex	
Meaning	An error was detected in the DIP switch setting.				
Source	PLC Function Module		Source details	None	Detection timing At power ON or Controller reset
Error attributes	Level	Major fault	Recovery	Cycle the power supply.	Log category System
Effects	User program	Stops.	Operation	Stops. *1	
System-defined variables	Variable	Data type		Name	
	None	---		---	
Cause and correction	Assumed cause		Correction		Prevention
	There is an error in the DIP switch setting.		Turn OFF all pins on the DIP switch.		Make sure that the DIP switch settings are correct.
Attached information	Attached information 1: DIP switch readout value (00000000 hex to 0000000F hex)				
Precautions/Remarks	None				

*1. For details, refer to *I/O Operation for Major Fault Level Controller Errors* on page 1-23.

Event name	Internal Bus Check Error		Event code	000D0000 hex	
Meaning	A fatal error was detected on the internal bus.				
Source	PLC Function Module		Source details	None	Detection timing Continuously
Error attributes	Level	Major fault	Recovery	Cycle the power supply.	Log category System
Effects	User program	Stops.	Operation	Stops.* ¹ A connection to the Sysmac Studio may not be possible.	
System-defined variables	Variable	Data type		Name	
	None	---		---	
Cause and correction	Assumed cause		Correction		Prevention
	A conductive material has gotten inside.		If there is conductive material nearby, blow out the CPU Unit with air.		Do not do any metal working in the vicinity of the control panel. Also, make sure that the operating environment is free of dirt and dust. Close the control panel.
	Noise <ul style="list-style-type: none"> • There is data corruption in bus signals. • There is malfunctioning in bus interface circuits. 		If the error occurs even after making the above correction, check the FG, and power supply lines, and other noise entry paths, and implement noise countermeasures as required.		Implement noise countermeasures.
	The CPU Unit has failed. <ul style="list-style-type: none"> • The internal bus is disconnected. 		If this error persists even after you make the above two corrections, replace the CPU Unit.		None
Attached information	Attached information 1: System information				
Precautions/Remarks	When this error occurs, the CPU Unit stops and the error is recorded in the event log. If cycling the power to the Controller clears the error, you will be able to see whether this error occurred by checking the event log. However, a restart is sometimes not possible depending on the error location.				

*1. For details, refer to *I/O Operation for Major Fault Level Controller Errors* on page 1-23.

Event name	Non-volatile Memory Life Exceeded		Event code	000E0000 hex	
Meaning	The specified number of deletions for non-volatile memory was exceeded. Or, the number of bad blocks in memory exceeded the specified value.				
Source	PLC Function Module		Source details	None	Detection timing At power ON, at Controller reset, or periodically
Error attributes	Level	Major fault	Recovery	Cycle the power supply.	Log category System
Effects	User program	Stops.	Operation	Stops.*1	
System-defined variables	Variable	Data type		Name	
	None	---		---	
Cause and correction	Assumed cause		Correction		Prevention
	Non-volatile memory life expired.		Replace the CPU Unit.		Depending on a user program or application, the non-volatile memory life may be shortened. Check the following 1 and 2. <ol style="list-style-type: none"> 1. Frequency of SD Memory Card backup processing by system-defined variables and special instructions 2. Frequency of instructions to write to non-volatile memory such as MC_SaveCamTable and ChangeIPAdr instructions If the execution of 1 or 2 above fails, re-execute after you remove the cause of the error. If you retry before you remove the cause of error, the number of deletions for non-volatile memory increases and the non-volatile memory life may be shortened.
Attached information	None				
Precautions/Remarks	None				

*1. For details, refer to *I/O Operation for Major Fault Level Controller Errors* on page 1-23.

Event name	CPU Unit Overheat (Operation Stopped)		Event code	00110000 hex	
Meaning	Operation was stopped because the temperature inside the CPU Unit was too high.				
Source	PLC Function Module		Source details	None	Detection timing Continuously
Error attributes	Level	Major fault	Recovery	Cycle the power supply or reset the Controller.	Log category System
Effects	User program	Stops.	Operation	Stops.* ¹ A connection to the Sysmac Studio is not possible.	
System-defined variables	Variable	Data type		Name	
	None	---		---	
Cause and correction	Assumed cause	Correction		Prevention	
	The ambient operating temperature is too high.	<p>Make sure that the ambient operating temperature stays between 0 and 55°C.</p> <ul style="list-style-type: none"> • Provide enough space for good air flow. • Do not install the Controller directly above equipment that generates a large amount of heat, such as heaters, transformers, or high-capacity resistors. • If the ambient temperature exceeds 55 °C, install a cooling fan or air conditioner. 		Make sure that the ambient temperature stays between 0 and 55°C.	
Attached information	None				
Precautions/Remarks	None				

*1. For details, refer to *I/O Operation for Major Fault Level Controller Errors* on page 1-23.

Event name	Main Memory Check Error		Event code	00130000 hex*1	
Meaning	An error was detected in the memory check of the main memory in the CPU Unit.				
Source	PLC Function Module		Source details	None	Detection timing Continuously
Error attributes	Level	Major fault	Recovery	Cycle the power supply or reset the Controller.	Log category System
Effects	User program	Stops.	Operation	Stops.*2	
System-defined variables	Variable	Data type		Name	
	None	---		---	
Cause and correction	Assumed cause		Correction		Prevention
	A conductive material has gotten inside.		If there is conductive material nearby, blow out the CPU Unit with air.		Do not do any metal working in the vicinity of the control panel. Use the control panel only when it is closed.
	Noise <ul style="list-style-type: none"> Data corruption in memory Microcomputer malfunctioning Memory write circuit malfunctioning 		If the error did not result from the above causes, cycle the power to the Controller and see if that clears the error. If the error occurs frequently, check the FG, power supply lines, and other noise entry paths, and implement noise countermeasures as required.		Implement noise countermeasures.
	There is a soft error. <ul style="list-style-type: none"> Data corruption was caused by cosmic rays or radiation. 		If the error did not result from the above causes, and cycling the power to the Controller or resetting the Controller does not clear the error, replace the CPU Unit.		None
	The CPU Unit has failed. <ul style="list-style-type: none"> Memory element failure Memory peripheral circuit failure 				Perform regular inspections.
Attached information	Attached information 1: System information Attached information 2: System information				
Precautions/Remarks	None				

*1. This event code occurs for the following CPU Units.

- NX102, NX1P2 CPU Unit: Version 1.13 or later
- NX502 CPU Unit: Version 1.60 or later
- NX701, NJ5 with the hardware revision B: Version 1.16 or later
- NJ3 with the hardware revision A: Version 1.17 or later
- NJ1 with the hardware revision A: Version 1.17 or later

*2. For details, refer to *I/O Operation for Major Fault Level Controller Errors* on page 1-23.

3 Error Descriptions and Corrections

Event name	Non-volatile Memory Restored or Formatted		Event code	10010000 hex	
Meaning	An error was detected in the non-volatile memory check and file system recovery or formatting was executed. Previous files may have been deleted.				
Source	PLC Function Module		Source details	None	Detection timing At power ON or Controller reset
Error attributes	Level	Major fault	Recovery	Cycle the power supply or reset the Controller.	Log category System
Effects	User program	Stops.	Operation	Stops.*1	
System-defined variables	Variable	Data type		Name	
	None	---		---	
Cause and correction	Assumed cause		Correction		Prevention
	<p>The Controller power supply was turned OFF while the BUSY indicator was lit.</p> <p>The power supply to the Controller was interrupted momentarily while the BUSY indicator was lit.</p>		<p>Compare the project with the project on the Sysmac Studio. If they match, cycle the power supply to the Controller or reset the Controller to see if that clears the error. If the error is cleared, check that the device operates correctly. If the comparison shows a mismatch, if the error is not cleared, or if the device does not operate correctly, clear all of memory and then download the project from the Sysmac Studio again. If cycling the power supply to the Controller or resetting the Controller does not clear the error, the memory is corrupted. Replace the CPU Unit. Unexpected operation may occur and can be very dangerous if the power to the Controller is cycled or the Controller is reset before you download the project again.</p>		<p>Do not turn OFF the power supply while the BUSY indicator is lit.</p> <p>Take appropriate measures to ensure that the specified power with the rated voltage and frequency is supplied in places where the power supply is unstable.</p>
Attached information	<p>Attached information 1: Recovered content</p> <ul style="list-style-type: none"> • (00000000 hex: File system recovery successful, • 00000001 hex: Formatted) 				
Precautions/Remarks	Make sure that the projects match and that the device operates correctly, or transfer the project again. If you cycle the power to the Controller or reset the Controller before you do this, unexpected operation may occur and can be very dangerous.				

*1. For details, refer to *I/O Operation for Major Fault Level Controller Errors* on page 1-23.

Event name	Non-volatile Memory Data Corrupted		Event code	10020000 hex	
Meaning	A file that must be in non-volatile memory is missing or corrupted.				
Source	PLC Function Module		Source details	None	Detection timing At power ON or Controller reset
Error attributes	Level	Major fault	Recovery	Cycle the power supply or reset the Controller.	Log category System
Effects	User program	Stops.	Operation	Stops.*1	
System-defined variables	Variable	Data type		Name	
	None	---		---	
Cause and correction	Assumed cause		Correction		Prevention
	The Controller power supply was turned OFF while the BUSY indicator was lit.		Clear all of memory and then download the project from the Sysmac Studio.		Do not turn OFF the power supply while the BUSY indicator is lit.
	The power supply to the Controller was interrupted momentarily while the BUSY indicator was lit.				Take appropriate measures to ensure that the specified power with the rated voltage and frequency is supplied in places where the power supply is unstable.
	The CPU Unit has failed.		If this error remains even after making the above corrections, replace the CPU Unit.		None
Attached information	None				
Precautions/Remarks	None				

*1. For details, refer to *I/O Operation for Major Fault Level Controller Errors* on page 1-23.

Event name	Main Memory Check Error		Event code	10080000 hex	
Meaning	An error was detected in the memory check of the main memory in the CPU Unit.				
Source	PLC Function Module		Source details	None	Detection timing Continuously
Error attributes	Level	Major fault	Recovery	Cycle the power supply.	Log category System
Effects	User program	Stops.	Operation	Stops.*1	
System-defined variables	Variable		Data type		Name
	None		---		---
Cause and correction	Assumed cause		Correction		Prevention
	A conductive material has gotten inside.		If there is conductive material nearby, blow out the CPU Unit with air.		Do not do any metal working in the vicinity of the control panel. Use the control panel only when it is closed.
	Noise <ul style="list-style-type: none"> Data corruption in memory Microcomputer malfunctioning Memory write circuit malfunctioning 		If the error did not result from the above causes, cycle the power to the Controller and see if that clears the error. If the error occurs frequently, check the FG, power supply lines, and other noise entry paths, and implement noise countermeasures as required.		Implement noise countermeasures.
	There is a soft error. <ul style="list-style-type: none"> Data corruption was caused by cosmic rays or radiation. 		If the error did not result from the above causes, and cycling the power to the Controller or resetting the Controller does not clear the error, replace the CPU Unit.		None
The CPU Unit has failed. <ul style="list-style-type: none"> Memory element failure Memory peripheral circuit failure 		Perform regular inspections.			
Attached information	Attached information 1: System information				
Precautions/Remarks	None				

*1. For details, refer to *I/O Operation for Major Fault Level Controller Errors* on page 1-23.

Event name	Data Not Saved to Battery-backup Memory		Event code	100A0000 hex*1	
Meaning	An error occurred in the software and data could not be saved in battery-backup memory during power-OFF processing.				
Source	PLC Function Module		Source details	None	Detection timing At power ON or Controller reset
Error attributes	Level	Major fault	Recovery	Cycle the power supply.	Log category System
Effects	User program	Stops.	Operation	Stops.*2 The variables with a Retain attribute and memory for CJ-series Units in the DM, EM, and Holding Areas do not contain the values from just before the power supply was turned OFF. Unless suitable processing countermeasures are implemented, normal user program execution or normal Unit operation may not be possible when the power is turned ON next time.	
System-defined variables	Variable	Data type		Name	
	_RetainUnexec*3	BOOL		Retention Inexecution Flag	
Cause and correction	Assumed cause		Correction		Prevention
	An error occurred in the software.		Perform the following: <ul style="list-style-type: none"> • Check the values of retained variables and the retained areas in the memory used for CJ-series Units and change them to the correct values. • If the system uses a Servomotor with an absolute encoder, turn ON the power supply, and then turn ON the Servo and check the actual current position of the axis. • After you perform the corrections, set the Retention Inexecution Flag (_RetainUnexec) to FALSE. 		None
Attached information	None				
Precautions/Remarks	If this error occurs, the values of the following will be the values from the previous time the power supply was turned ON. <ul style="list-style-type: none"> • Retained variables (variables with a Retain attribute or variables in retained areas with AT specifications) • Retained areas in the memory used for CJ-series Units • Absolute encoder home offset data After you perform the corrections, set the Retention Inexecution Flag (_RetainUnexec) to FALSE. To prevent the user program from operating with an unintended value in the retained variables or the retained areas in the memory used for CJ-series Units or in the absolute encoder home offset position data, use the Retention Inexecution Flag (_RetainUnexec) in the user program as an interlock condition as required.				

*1. This event code occurs for a CPU Unit with unit version 1.10 or later.

*2. For details, refer to *I/O Operation for Major Fault Level Controller Errors* on page 1-23.

*3. This system-defined variable is available only for the following CPU Units.

- NJ-series, NX502, NX102, NX1P2 CPU Unit: Version 1.64 or later
- NX701 CPU Unit: Version 1.35 or later

Event name	Non-volatile Memory Data Corrupted		Event code	100B0000 hex	
Meaning	A file that must be in non-volatile memory is missing or corrupted.				
Source	PLC Function Module		Source details	None	Detection timing At power ON or Controller reset
Error attributes	Level	Major fault	Recovery	Cycle the power supply or reset the Controller.	Log category System
Effects	User program	Stops.	Operation	Stops.*1	
System-defined variables	Variable	Data type		Name	
	None	---		---	
Cause and correction	Assumed cause		Correction		Prevention
	The Controller power supply was turned OFF while the BUSY indicator was lit.		Clear all of memory and then download the project from the Sysmac Studio.		Do not turn OFF the power supply while the BUSY indicator is lit.
	The power supply to the Controller was interrupted momentarily while the BUSY indicator was lit.				Take appropriate measures to ensure that the specified power with the rated voltage and frequency is supplied in places where the power supply is unstable.
The CPU Unit has failed.		If this error remains even after making the above corrections, replace the CPU Unit.		None	
Attached information	None				
Precautions/Remarks	None				

*1. For details, refer to *I/O Operation for Major Fault Level Controller Errors* on page 1-23.

Event name	Event Level Setting Error		Event code	100C0000 hex	
Meaning	The settings in the event level setting file are not correct.				
Source	PLC Function Module		Source details	None	Detection timing At power ON or Controller reset
Error attributes	Level	Major fault	Recovery	Cycle the power supply or reset the Controller.	Log category System
Effects	User program	Stops.	Operation	Stops.* ¹	
System-defined variables	Variable	Data type		Name	
	None	---		---	
Cause and correction	Assumed cause		Correction		Prevention
	The event level settings are not correct because the power supply to the Controller was interrupted or communications with the Sysmac Studio were disconnected during a download of the event level settings.		Perform a Memory All Clear operation and then transfer the event level setting file again.		Do not interrupt the power supply to the Controller or disconnect communications with the Sysmac Studio during a download of the event level settings.
	The event level settings are not correct because the power supply to the Controller was interrupted during a Clear All Memory operation.				Do not interrupt the power supply to the Controller during a Clear All Memory operation.
Non-volatile memory failed.		If the error persists even after you make the above correction, replace the CPU Unit.		None	
Attached information	None				
Precautions/Remarks	None				

*1. For details, refer to *I/O Operation for Major Fault Level Controller Errors* on page 1-23.

Event name	Present Values of Retained Variables Restoration Error		Event code	100F0000 hex	
Meaning	The present values of retained variables could not be restored at startup and the values were initialized.				
Source	PLC Function Module		Source details	None	Detection timing At power ON or Controller reset
Error attributes	Level	Major fault	Recovery	Cycle the power supply or reset the Controller.	Log category System
Effects	User program	Stops.	Operation	Stops.* ¹ The variables with a Retain attribute and memory for CJ-series Units in the DM, EM, and Holding Areas were corrupted. Normal user program execution or normal Unit operation may not be possible.	
System-defined variables	Variable		Data type		Name
	_RetainFail		BOOL		Retention Failure Flag
	_RetainUnexec ^{*2}		BOOL		Retention Inexecution Flag
Cause and correction	Assumed cause		Correction		Prevention
	<ul style="list-style-type: none"> An error occurred in the software. Backup memory failure 		Perform the following: <ul style="list-style-type: none"> Check the values of the retained variables and the retained areas in the memory used for CJ-series Units and change them to the correct values. After you perform the corrections, set the Retention Inexecution Flag (_RetainUnexec) to FALSE. (NX502, NX102 and NX1P2 CPU Unit) If this error persists, replace the CPU Unit. 		None
Attached information	None				
Precautions/Remarks	The following values are initialized. <ul style="list-style-type: none"> Retained variables (variables with Retain attribute or variables with AT specification in the retained area) Retained area in the memory used for CJ-series Units <ul style="list-style-type: none"> After you perform the corrections, set the Retention Inexecution Flag (_RetainUnexec) to FALSE. To prevent the user program from operating with an unintended value in the retained variables or the retained areas in the memory used for CJ-series Units, use the Retention Inexecution Flag (_RetainUnexec) in the user program as an interlock condition as required. 				

*1. For details, refer to *I/O Operation for Major Fault Level Controller Errors* on page 1-23.

*2. This system-defined variable is available only for the following CPU Units.

- NX502, NX102, NX1P2 CPU Unit: Version 1.64 or later
- NX701 CPU Unit: Version 1.35 or later

Event name	Present Values of Retained Variables Not Saved		Event code	10100000 hex		
Meaning	<p>The process of saving the current value of the retained variable during power interruptions could not be performed because an error occurred in the software. (NX502, NX102, and NX1P2 CPU Unit)(Communication Control Unit)</p> <p>The process of saving the current value of the retained variable during power interruptions could not be performed because the Controller was forcibly shut down or an error occurred in the software. (NY-series Controller)</p>					
Source	PLC Function Module		Source details	None	Detection timing	At power ON or Controller reset
Error attributes	Level	Major fault	Recovery	Cycle the power supply.	Log category	System
Effects	User program	Stops.	Operation	<p>Stops.*1</p> <p>The values of the variables with a Retain attribute and memory for CJ-series Units in the DM, EM, and Holding Areas were not same as the values just before the power interruption. Normal user program execution or normal Unit operation may not be possible.</p>		
System-defined variables	Variable	Data type		Name		
	_RetainUnexec*2	BOOL		Retention Inexecution Flag		
Cause and correction	Assumed cause		Correction		Prevention	
	A forced shutdown is performed. (NY-series Controllers)		<p>Perform the following:</p> <ul style="list-style-type: none"> Check the values of the retained variables and change them to the correct values. (NY-series Controller) If the system uses a Servomotor with an absolute encoder, turn ON the power supply, and then turn ON the Servo and check the actual current position of the axis. <p>(NX502, NX102 and NX1P2 CPU Unit)</p> <ul style="list-style-type: none"> Check the values of the retained variables and the retained areas in the memory used for CJ-series Units and change them to the correct values. After you perform the corrections, set the Retention Inexecution Flag (_RetainUnexec) to FALSE. 		Perform a shutdown with other method than the forced shutdown. (NY-series Controllers)	
	An error occurred in the software.				None	
Attached information	None					
Precautions/Remarks	<p>The values of the following will be the values from the previous time the power supply wasturned ON.</p> <ul style="list-style-type: none"> Absolute encoder home offset data Retained variables (variables with Retain attribute or variables with AT specification in the retained area) Retained area in the memory used for CJ-series Units After you perform the corrections, set the Retention Inexecution Flag (_RetainUnexec) to FALSE. To prevent the user program from operating with an unintended value in the retained variables or the retained areas in the memory used for CJ-series Units or in the absolute encoder home offset position data, use the Retention Inexecution Flag (_RetainUnexec) in the user program as an interlock condition as required. 					

*1. For details, refer to *I/O Operation for Major Fault Level Controller Errors* on page 1-23.

*2. This system-defined variable is available only for the following CPU Units.

- NX502, NX102, NX1P2 CPU Unit: Version 1.64 or later

Event name	PLC System Processing Error		Event code	40010000 hex		
Meaning	A fatal error was detected in the PLC Function Module.					
Source	PLC Function Module		Source details	None	Detection timing	Continuously
Error attributes	Level	Major fault	Recovery	Cycle the power supply.	Log category	System
Effects	User program	Stops.	Operation	Stops.*1 A connection to the Sysmac Studio is not possible.		
System-defined variables	Variable		Data type		Name	
	None		---		---	
Cause and correction	Assumed cause		Correction		Prevention	
	An error occurred in the software.		Contact your OMRON representative.		None	
Attached information	None					
Precautions/Remarks	None					

*1. For details, refer to *I/O Operation for Major Fault Level Controller Errors* on page 1-23.

Event name	PLC System Processing Error		Event code	40020000 hex		
Meaning	A fatal error was detected in the PLC Function Module.					
Source	PLC Function Module		Source details	None	Detection timing	Continuously
Error attributes	Level	Major fault	Recovery	Cycle the power supply.	Log category	System
Effects	User program	Stops.	Operation	Stops.*1		
System-defined variables	Variable		Data type		Name	
	None		---		---	
Cause and correction	Assumed cause		Correction		Prevention	
	An error occurred in the software.		Contact your OMRON representative.		None	
Attached information	None					
Precautions/Remarks	None					

*1. For details, refer to *I/O Operation for Major Fault Level Controller Errors* on page 1-23.

Event name	PLC System Processing Error			Event code	40030000 hex
Meaning	A fatal error was detected in the PLC Function Module.				
Source	PLC Function Module		Source details	None	Detection timing Continuously
Error attributes	Level	Major fault	Recovery	Cycle the power supply.	Log category System
Effects	User program	Stops.	Operation	Stops.*1	
System-defined variables	Variable		Data type		Name
	None		---		---
Cause and correction	Assumed cause		Correction		Prevention
	An error occurred in the software.		Contact your OMRON representative.		None
Attached information	Attached information 1: System information				
Precautions/Remarks	None				

*1. For details, refer to *I/O Operation for Major Fault Level Controller Errors* on page 1-23.

Event name	PLC System Processing Error			Event code	40040000 hex
Meaning	A fatal error was detected in the PLC Function Module.				
Source	PLC Function Module		Source details	None	Detection timing Continuously
Error attributes	Level	Major fault	Recovery	Cycle the power supply.	Log category System
Effects	User program	Stops.	Operation	Stops.*1 A connection to the Sysmac Studio is not possible.	
System-defined variables	Variable		Data type		Name
	None		---		---
Cause and correction	Assumed cause		Correction		Prevention
	An error occurred in the software.		Contact your OMRON representative.		None
Attached information	None				
Precautions/Remarks	None				

*1. For details, refer to *I/O Operation for Major Fault Level Controller Errors* on page 1-23.

Event name	PLC System Processing Error			Event code	40050000 hex	
Meaning	A fatal error was detected in the PLC Function Module.					
Source	PLC Function Module		Source details	None	Detection timing	Continuously
Error attributes	Level	Major fault	Recovery	Cycle the power supply.	Log category	System
Effects	User program	Stops.	Operation	Stops.*1 A connection to the Sysmac Studio is not possible.		
System-defined variables	Variable	Data type		Name		
	None	---		---		
Cause and correction	Assumed cause		Correction		Prevention	
	An error occurred in the software.		Contact your OMRON representative.		None	
Attached information	None					
Precautions/Remarks	None					

*1. For details, refer to *I/O Operation for Major Fault Level Controller Errors* on page 1-23.

Event name	Real-Time Clock Stopped			Event code	00070000 hex	
Meaning	The oscillation of the real-time clock stopped. The real-time clock is set to an illegal time.					
Source	PLC Function Module		Source details	None	Detection timing	At power ON or Controller reset
Error attributes	Level	Minor fault	Recovery	Error reset	Log category	System
Effects	User program	Continues.	Operation	The System Time is not defined. The clock information recorded by CJ-series Units is also not defined.		
System-defined variables	Variable	Data type		Name		
	_CurrentTime	DATE_AND_TIME		System Time		
Cause and correction	Assumed cause		Correction		Prevention	
	The battery voltage is low.		Replace the Battery. Then adjust the real-time clock time.		Regularly replace the Battery.	
	The battery connector has come loose.		Reconnect the connector and make sure it is mated correctly. Then adjust the real-time clock time.		Check for vibration and shock.	
	The Battery is missing.		Install a Battery. Then adjust the real-time clock time.		Install a Battery.	
Attached information	None					
Precautions/Remarks	This error is checked only when the power is turned ON. You can change the event level to the observation level. If you change the level to the observation level, recovery procedures are not required.					

Event name	Real-Time Clock Failed			Event code	00080000 hex
Meaning	The real-time clock in the CPU Unit failed.				
Source	PLC Function Module		Source details	None	Detection timing At power ON or Controller reset
Error attributes	Level	Minor fault	Recovery	Cycle the power supply.	Log category System
Effects	User program	Continues.	Operation	The System Time is not defined. The clock information recorded by CJ-series Units is also not defined.	
System-defined variables	Variable	Data type		Name	
	_CurrentTime	DATE_AND_TIME		System Time	
Cause and correction	Assumed cause		Correction		Prevention
	The CPU Unit clock has failed.		Replace the CPU Unit.		None
Attached information	None				
Precautions/Remarks	None				

Event name	Low Battery Voltage			Event code	000B0000 hex
Meaning	The voltage of the Battery has dropped.				
Source	PLC Function Module		Source details	None	Detection timing Continuously
Error attributes	Level	Minor fault	Recovery	Error reset	Log category System
Effects	User program	Continues.	Operation	No affected.	
System-defined variables	Variable	Data type		Name	
	_SelfTest_LowBattery	BOOL		Low Battery Flag	
Cause and correction	Assumed cause		Correction		Prevention
	The battery voltage is low.		Replace the Battery.		Regularly replace the Battery.
	The battery connector has come loose.		Reconnect the connector and make sure it is mated correctly.		Check for vibration and shock.
	The Battery is missing.		Install a Battery.		Install a Battery.
Attached information	None				
Precautions/Remarks	<p>For the NJ-series CPU Units and NX701 CPU Units, you may lose the user data the next time that the power supply is interrupted.</p> <p>For the NX1P2 CPU Units and NX102 CPU Units, you may lose the clock data the next time that the power supply is interrupted.</p> <p>You can change the event level to the observation level. If you change the level to the observation level, recovery procedures are not required.</p>				

Event name	CPU Unit Overheat			Event code	000C0000 hex	
Meaning	The temperature inside the CPU Unit exceeded the specified value.					
Source	PLC Function Module		Source details	None	Detection timing	Continuously
Error attributes	Level	Minor fault	Recovery	Cycle the power supply or reset the Controller.	Log category	System
Effects	User program	Continues.	Operation	Not affected.		
System-defined variables	Variable		Data type		Name	
	_SelfTest_HighTemperature		BOOL		CPU Unit High Temperature Flag	
Cause and correction	Assumed cause		Correction		Prevention	
	The ambient operating temperature is too high.		<p>Make sure that the ambient operating temperature stays between 0 and 55°C.</p> <ul style="list-style-type: none"> • Provide enough space for good air flow. • Do not install the Controller above equipment that generates a large amount of heat, such as heaters, transformers, or high-capacity resistors. • If the ambient temperature exceeds 55 °C, install a cooling fan or air conditioner. 		Make sure that the ambient temperature stays between 0 and 55°C.	
Attached information	None					
Precautions/Remarks	None					

Event name	Slow Fan			Event code	00120000 hex	
Meaning	The speed of the fan dropped to a specified level or lower.					
Source	PLC Function Module		Source details	None	Detection timing	Continuously
Error attributes	Level	Minor fault	Recovery	Error reset	Log category	System
Effects	User program	Continues.	Operation	Not affected.		
System-defined variables	Variable		Data type		Name	
	_SelfTest_LowFanRevolution		BOOL		Low FAN Revolution Flag	
Cause and correction	Assumed cause		Correction		Prevention	
	There is an obstacle that prevents the operation of the fan.		Remove the material that is interfering with fan operation.		Make sure that nothing is interfering with the fan during operation.	
	The fan has reached the end of its service life.		NX701 CPU Unit: Replace the Fan Unit. *1		NX701 CPU Unit: Perform regular Fan Unit replacements.	
	The fan is faulty.		NX502 CPU Unit: Replace the CPU Unit. NY-series Controller: Replace the fan unit. <i>Errors for Self Diagnosis</i> on page 3-95		NX502 CPU Unit: None	
Attached information	None					
Precautions/Remarks	None					

*1. Refer to the *NX-series CPU Unit Hardware User's Manual (Cat. No. W535)* for the Fan Unit replacement procedure and life.

Event name	Non-volatile Memory Life Warning		Event code	00150000 hex*1	
Meaning	The warning number of deletions for non-volatile memory was exceeded. Or, the number of bad blocks in memory exceeded the warning value.				
Source	PLC Function Module		Source details	None	Detection timing At power ON, at Controller reset, or periodically
Error attributes	Level	Minor fault	Recovery	---	Log category System
Effects	User program	Continues.	Operation	Not affected.	
System-defined variables	Variable	Data type	Name		
	_StorageDeteriorated	BOOL	Non-volatile Memory Life Warning Flag		
Cause and correction	Assumed cause	Correction	Prevention		
	Non-volatile memory life expired.	Non-volatile memory life is ending. Replace the CPU Unit.	<p>Depending on a user program or application, the non-volatile memory life may be shortened. Check the following 1 and 2.</p> <ol style="list-style-type: none"> 1. Frequency of SD Memory Card backup processing by system-defined variables and special instructions 2. Frequency of instructions to write to non-volatile memory such as MC_SaveCamTable and ChangeIPAdr instructions <p>If the execution of 1 or 2 above fails, re-execute after you remove the cause of the error. If you retry before you remove the cause of error, the number of deletions for non-volatile memory increases and the non-volatile memory life may be shortened.</p>		
Attached information	None				
Precautions/Remarks	If you continue to use the Controller, reading or writing in non-volatile memory may fail. This may cause problems such as a failure to start the Controller or a user program transfer failure.				

*1. This event code occurs for the following CPU Units.

- NJ-series, NX102, NX1P2, NX502 CPU Unit: Version 1.60 or later
- NX701 CPU Unit: Version 1.32 or later

Event name	Battery-backup Memory Check Error		Event code	10090000 hex		
Meaning	An error was detected in the memory check of the battery-backup memory in the CPU Unit.					
Source	PLC Function Module or Motion Control Function Module		Source details	PLC Function Module: None Motion Control Function Module: MC Common	Detection timing	At power ON or Controller reset
Error attributes	Level	Minor fault	Recovery	Error reset	Log category	System
Effects	User program	Continues.	Operation	The variables with a Retain attribute and memory for CJ-series Units in the DM, EM, and Holding Areas were corrupted. Normal user program execution or normal Unit operation may not be possible.		
System-defined variables	Variable	Data type		Name		
	_RetainFail	BOOL		Retention Failure Flag		
	_RetainUnexec ^{*1}	BOOL		Retention Inexecution Flag		
Cause and correction	Assumed cause		Correction		Prevention	
	The battery voltage is low.		<ul style="list-style-type: none"> Replace the Battery. Check the values of the retained variables and the retained areas in the memory used for CJ-series Units and change them to the correct values. After you perform the corrections, set the Retention Inexecution Flag (_RetainUnexec) to FALSE. 		Regularly replace the Battery.	
	The battery connector has come loose.		<ul style="list-style-type: none"> Check that the connector is fitted correctly and reconnect the connector. Check the values of the retained variables and the retained areas in the memory used for CJ-series Units and change them to the correct values. After you perform the corrections, set the Retention Inexecution Flag (_RetainUnexec) to FALSE. 		Check the impact of shock and vibration.	
	The Battery is missing.		<ul style="list-style-type: none"> Install a Battery. Check the values of the retained variables and the retained areas in the memory used for CJ-series Units and change them to the correct values. After you perform the corrections, set the Retention Inexecution Flag (_RetainUnexec) to FALSE. 		Install a Battery.	
Attached information	None					

Precautions/Remarks	<p>The values are initial values in the following area:</p> <ul style="list-style-type: none"> Retained variables (variables with Retain attribute or variables with AT specification in the retained area) Retained area in the memory used for CJ-series Units <p>After you perform the corrections, set the Retention Inexecution Flag (<code>_RetainUnexec</code>) to FALSE. To prevent the user program from operating with an unintended value in the retained variables or the retained areas in the memory used for CJ-series Units, use the Retention Inexecution Flag (<code>_RetainUnexec</code>) in the user program as an interlock condition as required.</p>
----------------------------	---

- *1. This system-defined variable is available only for the following CPU Units.
- NJ-series, NX502, NX102, NX1P2 CPU Unit: Version 1.64 or later
 - NX701 CPU Unit: Version 1.35 or later

Event name	SD Memory Card Invalid Type		Event code	000F0000 hex	
Meaning	The current SD Memory Card is not supported.				
Source	PLC Function Module		Source details	None	Detection timing At power ON, at Controller reset, or when SD Memory Card is inserted
Error attributes	Level	Observation	Recovery	---	Log category System
Effects	User program	Continues.	Operation	SD PWR indicator is not lit. Power supply to SD Memory Card is stopped.	
System-defined variables	Variable	Data type		Name	
	<code>_Card1Ready</code>	BOOL		SD Memory Card Ready Flag	
Cause and correction	Assumed cause	Correction		Prevention	
	An SD Memory Card that is not supported was inserted into the CPU Unit.	<p>Replace with an HMC-SD291 SD Memory Card, an HMC-SD491 SD Memory Card, or an HMC-SD1A1 SD Memory Card.</p> <p>In the following case, replace with an HMC-SD491 SD Memory Card or an HMC-SD1A1 SD Memory Card.</p> <ul style="list-style-type: none"> For NJ501-□□□□ CPU Units, the hardware revision is "A" and the unit version is 1.15 or later. 		<p>Use an HMC-SD291 SD Memory Card, an HMC-SD491 SD Memory Card, or an HMC-SD1A1 SD Memory Card.</p> <p>In the following case, use an HMC-SD491 SD Memory Card or an HMC-SD1A1 SD Memory Card.</p> <ul style="list-style-type: none"> For NJ501-□□□□ CPU Units, the hardware revision is "A" and the unit version is 1.15 or later. 	
Attached information	Attached information 1: "Not UHS-I" is displayed when the SD Memory Card does not support UHS-I.				
Precautions/Remarks	None				

Event name	SD Memory Card Life Exceeded		Event code	00100000 hex		
Meaning	The specified number of deletions for the SD Memory Card was exceeded. Or, the number of bad blocks exceeded the specified value.					
Source	PLC Function Module		Source details	None	Detection timing	At power ON, at Controller reset, or periodically
Error attributes	Level	Observation	Recovery	---	Log category	System
Effects	User program	Continues.	Operation	Not affected.		
System-defined variables	Variable		Data type		Name	
	_Card1Deteriorated		BOOL		SD Memory Card Life Warning Flag	
Cause and correction	Assumed cause		Correction		Prevention	
	The service life of the SD Memory Card was exceeded.		Back up necessary files in the SD Memory Card. Or replace the SD Memory Card.		Regularly replace the SD Memory Card.	
Attached information	None					
Precautions/Remarks	<ul style="list-style-type: none"> The data on the SD Memory Card may be corrupted. Normal user program operation may not be possible. You can change the event level to the minor fault level. If you change the level to the minor fault level, the Recovery column above will be changed to "Error reset." Combination of the CPU Unit version and SD Memory Card determines whether the SD memory card life expiration detection function can be used or not. Refer to <i>Specification of Supported SD Memory Cards, Folders, and Files</i> in the <i>NJ/NX-series CPU Unit Software User's Manual (Cat. No. W501)</i> for details. 					

Event name	SD Memory Card Invalid Format		Event code	10030000 hex		
Meaning	The file format of the SD Memory Card is not FAT16 or FAT32.					
Source	PLC Function Module		Source details	None	Detection timing	At power ON, at Controller reset, or when SD Memory Card is inserted
Error attributes	Level	Observation	Recovery	---	Log category	System
Effects	User program	Continues.	Operation	SD PWR indicator is not lit. You can format the SD Memory Card from the Sysmac Studio.		
System-defined variables	Variable		Data type		Name	
	_Card1Ready		BOOL		SD Memory Card Ready Flag	
Cause and correction	Assumed cause		Correction		Prevention	
	The file format of the SD Memory Card inserted in the CPU Unit is not FAT16 or FAT32.		<p>Make sure that the correct SD Memory Card is inserted in the CPU Unit.</p> <p>If an incorrect SD Memory Card is inserted, replace it with the correct one.</p> <p>If the correct SD Memory Card is inserted, format it correctly before you use it.</p>		Use an OMRON SD Memory Card. Do not format the SD Memory Card on a computer.	
Attached information	None					
Precautions/Remarks	None					

Event name	SD Memory Card Restored or Formatted		Event code	10040000 hex	
Meaning	An error was detected during the file system check and the file system was restored. Files may have been deleted.				
Source	PLC Function Module		Source details	None	Detection timing At power ON or Controller reset
Error attributes	Level	Observation	Recovery	---	Log category System
Effects	User program	Continues.	Operation	If the file is deleted, normal user program operation may not be possible.	
System-defined variables	Variable	Data type		Name	
	None	---		---	
Cause and correction	Assumed cause		Correction		Prevention
	The Controller power supply was turned OFF while the SD BUSY indicator was lit.		Check that the correct file is on the SD Memory Card, or that the device operates correctly.		Do not turn OFF the power supply while the SD BUSY indicator is lit.
	The power supply to the Controller was interrupted momentarily while the SD BUSY indicator was lit.		If the correct file is not on the SD Memory Card, or if the device does not operate correctly, download the correct file to the SD Memory Card. Cycle the power supply to the Controller or reset the Controller and confirm that the system operates correctly.		Take appropriate measures to ensure that the specified power with the rated voltage and frequency is supplied in places where the power supply is unstable.
	The SD Memory Card was removed while the SD PWR indicator was lit.		If this error occurs even though the above problem does not exist, replace the SD Memory Card and download the correct files to it.		Do not remove the SD Memory Card while the SD PWR indicator is lit.
	The SD Memory Card is damaged.				None
Attached information	None				
Precautions/Remarks	The error is detected at power ON or at a Controller reset only when SD Memory Card diagnosis at startup is enabled. You can change the event level to the minor fault level. If you change the level to the minor fault level, the Recovery column above will be changed to "Error reset."				

Event name	SD Memory Card Data Corrupted		Event code	10060000 hex	
Meaning	A file that must be in the SD Memory Card is missing or corrupted.				
Source	PLC Function Module		Source details	None	Detection timing At power ON or Controller reset
Error attributes	Level	Observation	Recovery	---	Log category System
Effects	User program	Continues.	Operation	SD PWR indicator is not lit. You can format the SD Memory Card from the Sysmac Studio. Normal user program operation may not be possible.	
System-defined variables	Variable	Data type		Name	
	_Card1Ready	BOOL		SD Memory Card Ready Flag	
Cause and correction	Assumed cause		Correction		Prevention
	The Controller power supply was turned OFF while the SD BUSY indicator was lit.		Format the SD Memory Card and download the correct file.		Do not turn OFF the power supply while the SD BUSY indicator is lit.
	The power supply to the Controller was interrupted momentarily while the SD BUSY indicator was lit.				Take appropriate measures to ensure that the specified power with the rated voltage and frequency is supplied in places where the power supply is unstable.
	The SD Memory Card was removed while the SD PWR indicator was lit.				Do not remove the SD Memory Card while the SD PWR indicator is lit.
	The SD Memory Card is damaged.		If the error cannot be cleared with the above corrections, replace the SD Memory Card with one that operates normally.		None
Attached information	None				
Precautions/Remarks	The error is detected at power ON or at a Controller reset only when SD Memory Card diagnosis at startup is enabled. You can change the event level to the minor fault level. If you change the level to the minor fault level, the Recovery column above will be changed to "Error reset."				

Event name	SD Memory Card Access Power OFF Error		Event code	10070000 hex	
Meaning	The power supply to the Controller was interrupted during access to the SD Memory Card.				
Source	PLC Function Module		Source details	None	Detection timing At power ON or Controller reset
Error attributes	Level	Observation	Recovery	---	Log category System
Effects	User program	Continues.	Operation	Operation is controlled by the user program when the file is corrupted.	
System-defined variables	Variable	Data type		Name	
	_Card1PowerFail	BOOL		SD Memory Card Power Interrup- tion Flag	
Cause and correction	Assumed cause		Correction		Prevention
	The Controller power supply was turned OFF while the SD BUSY indicator was lit.		Check that the correct file is on the SD Memory Card, or that the device operates correctly.		Do not turn OFF the power supply while the SD BUSY indicator is lit.
	The power supply to the Controller was interrupted momentarily while the SD BUSY indicator was lit.		If the correct file is not on the SD Memory Card, or if the device does not operate correctly, download the correct file to the SD Memory Card. Cycle the power supply to the Controller or reset the Controller and confirm that the system operates correctly. When you have finished the corrections, change the _Card1PowerFail (SD Memory Card Power Interruption Flag) system-defined variable to FALSE.		Take appropriate measures to ensure that the specified power with the rated voltage and frequency is supplied in places where the power supply is unstable.
Attached information	None				
Precautions/Remarks	When the measure is completed, change the SD Memory Card Power Interruption Flag to FALSE.				

Event name	PLC System Information		Event code	10130000 hex	
Meaning	This event provides internal information from the PLC Function Module.				
Source	PLC Function Module		Source details	None	Detection timing Continuously
Error attributes	Level	Observation	Recovery	---	Log category System
Effects	User program	Continues.	Operation	Not affected.	
System-defined variables	Variable	Data type		Name	
	None	---		---	
Cause and correction	Assumed cause		Correction		Prevention
	This event provides internal information from the PLC Function Module. It is recorded to provide additional information for another event.		---		---
Attached information	None				
Precautions/Remarks	None				

Event name	Incorrect SD Memory Card Removal		Event code	10310000 hex	
Meaning	SD Memory Card removal processing failed.				
Source	PLC Function Module		Source details	None	Detection timing At SD Memory Card removal
Error attributes	Level	Observation	Recovery	---	Log category System
Effects	User program	Continues.	Operation	Not affected.	
System-defined variables	Variable	Data type		Name	
	None	---		---	
Cause and correction	Assumed cause	Correction		Prevention	
	The SD Memory Card was removed while the SD PWR indicator was lit.	Check the files on the SD Memory Card to see if they are correct. If the files on the SD Memory Card are not correct, download the correct files to the SD Memory Card.		Press the SD Memory Card power supply switch and confirm that the SD PWR indicator goes out before you remove the SD Memory Card.	
Attached information	None				
Precautions/Remarks	None				

Errors Related to CJ-series Unit Configuration

Event name	I/O Bus Check Error		Event code	04010000 hex	
Meaning	An error occurred in a bus line transmission between the CPU Unit and the Units in the rack slots. Or, detection of all Special I/O Units and CPU Bus Units was not completed when the power supply to the Controller was turned ON.				
Source	PLC Function Module		Source details	I/O bus master	Detection timing Continuously
Error attributes	Level	Major fault	Recovery	Cycle the power supply.	Log category System
Effects	User program	Stops.	Operation	Stops. *1	
System-defined variables	Variable	Data type		Name	
	None	---		---	
Cause and correction	Assumed cause		Correction		Prevention
	The I/O Connecting Cable is disconnected or wires inside it are broken.		Make sure that the I/O cable connector is mated properly and then reconnect the connector. If the I/O cable is broken, replace it.		Make sure the cable is mated properly during operation. Check for vibration and shock.
	A conductive material has gotten inside.		If there is conductive material nearby, blow out the Units with air.		Do not do any metal working in the vicinity of the control panel. Use the control panel only when it is closed.
	The connector contact is faulty due to foreign material in the connector.		If foreign material is stuck to the connector, take off the connector and remove the foreign material.		Make sure that the operating environment is free of dirt and dust.
	Noise <ul style="list-style-type: none"> • There is data corruption in bus signals. • There is malfunctioning in bus interface circuits. 		If the error did not result from the above causes, cycle the power to the Controller and see if that clears the error. If the error occurs frequently, check the FG, power supply lines, I/O Connecting Cables, and other noise entry paths, and implement noise countermeasures as required.		Implement noise countermeasures.
	A Unit has failed. <ul style="list-style-type: none"> • CPU Unit • Special I/O Unit • CPU Bus Unit • I/O Connecting Cable 		If the error did not result from the above causes, and cycling the power to the Controller or resetting the Controller does not clear the error, replace the attached Unit or the CPU Unit.		Perform regular inspections.
Attached information	None				
Precautions/Remarks	None				

*1. For details, refer to *I/O Operation for Major Fault Level Controller Errors* on page 1-23.

3 Error Descriptions and Corrections

Event name	Unsupported Unit Detected		Event code	24010000 hex		
Meaning	An unsupported CJ-series Unit or Power Supply Unit is mounted.					
Source	PLC Function Module		Source details	I/O bus master	Detection timing	At power ON or Controller reset
Error attributes	Level	Major fault	Recovery	Cycle the power supply.	Log category	System
Effects	User program	Stops.	Operation	Stops. *1		
System-defined variables	Variable	Data type		Name		
	None	---		---		
Cause and correction	Assumed cause		Correction		Prevention	
	An unsupported CJ-series Unit or Power Supply Unit was detected.		Remove the unsupported CJ-series CPU Unit or Power Supply Unit and replace it with a supported one.		Use a Unit that is supported by this CPU Unit.	
Attached information	Attached information 1: Rack number where error was detected, 0 to 3 Attached information 2: Slot number where error was detected, 0 to 9 Attached information 3: Profile code that gives the Unit type					
Precautions/Remarks	This error will not occur for unsupported Power Supply Units that are mounted on Expansion Rack. Make sure that the Power Supply Units connected to the Expansion Racks are supported before using them.					

*1. For details, refer to *I/O Operation for Major Fault Level Controller Errors* on page 1-23.

Event name	Too Many I/O Points		Event code	24020000 hex		
Meaning	The total number of I/O points in the connected CJ-series Units exceeds the maximum specified value of the CPU Unit.					
Source	PLC Function Module		Source details	I/O bus master	Detection timing	At power ON or Controller reset
Error attributes	Level	Major fault	Recovery	Cycle the power supply.	Log category	System
Effects	User program	Stops.	Operation	Stops. *1		
System-defined variables	Variable	Data type		Name		
	None	---		---		
Cause and correction	Assumed cause		Correction		Prevention	
	The total number of I/O points in the connected CJ-series Basic I/O Units exceeds 2,560.		Set the total number of I/O points in the CJ-series Basic I/O Units to 2,560 or less.		Set the total number of I/O points in the CJ-series Basic I/O Units to 2,560 or less.	
Attached information	Attached information 1: Total number of I/O points in the CJ-series Basic I/O Units					
Precautions/Remarks	None					

*1. For details, refer to *I/O Operation for Major Fault Level Controller Errors* on page 1-23.

Event name	End Cover Missing		Event code	24030000 hex	
Meaning	The End Cover is not connected to right end of the CPU Rack or an Expansion Rack.				
Source	PLC Function Module		Source details	I/O bus master	Detection timing Continuously
Error attributes	Level	Major fault	Recovery	Cycle the power supply.	Log category System
Effects	User program	Stops.	Operation	Stops. *1	
System-defined variables	Variable	Data type		Name	
	None	---		---	
Cause and correction	Assumed cause		Correction		Prevention
	The End Cover is not connected to right end of the CPU Rack or an Expansion Rack.		Check that the End Cover is correctly connected and firmly attached. If it is not, connect it properly.		Design a Unit configuration that includes the End Cover.
	The End Cover is not connected properly.				Confirm that End Cover is connected correctly when you assemble the Controller.
Attached information	None				
Precautions/Remarks	None				

*1. For details, refer to *I/O Operation for Major Fault Level Controller Errors* on page 1-23.

Event name	Incorrect Unit/Expansion Rack Connection		Event code	24040000 hex	
Meaning	The number of Units or Expansion Racks exceeds the maximum value specified for the CPU Unit. Or, an Interrupt Input Unit was mounted to a unsupported slot or to an Expansion Rack.				
Source	PLC Function Module		Source details	I/O bus master	Detection timing At power ON or Controller reset
Error attributes	Level	Major fault	Recovery	Cycle the power supply.	Log category System
Effects	User program	Stops.	Operation	Stops. *1	
System-defined variables	Variable	Data type		Name	
	None	---		---	
Cause and correction	Assumed cause		Correction		Prevention
	More than 10 Units are connected to one Rack.		Reduce the number of Units connected to the Rack to 10 or fewer.		Check the maximum number of connections allowed and design a configuration that fits within those ranges.
	More than three Expansion Racks are connected.		Reduce the number of Expansion Racks to three or fewer.		
	More than two Interrupt Input Units are mounted.		Reduce the number of Interrupt Input Units to two or fewer.		
	An Interrupt Input Unit was mounted to a unsupported slot or to an Expansion Rack.		Mount the Interrupt Input Units to slots 0 to 4 on the CPU Rack (i.e., as one of the five Units to the right of the CPU Unit).		
Attached information	None				
Precautions/Remarks	None				

*1. For details, refer to *I/O Operation for Major Fault Level Controller Errors* on page 1-23.

Event name	Duplicate Unit Number		Event code	24050000 hex		
Meaning	The same unit number is set for more than one Special I/O Unit or more than one CPU Bus Unit.					
Source	PLC Function Module		Source details	I/O bus master	Detection timing	At power ON or Controller reset
Error attributes	Level	Major fault	Recovery	Cycle the power supply.	Log category	System
Effects	User program	Stops.	Operation	Stops. *1		
System-defined variables	Variable	Data type		Name		
	None	---		---		
Cause and correction	Assumed cause		Correction		Prevention	
	The same unit number is set for more than one Special I/O Unit or more than one CPU Bus Unit.		Check that the same unit number is not used for more than one Special I/O Unit or CPU Bus Unit by checking the rotary switches. If the same unit number is used more than once for the same Unit configuration, change the unit number.		Make sure that the same unit number is not used for more than one Special I/O Unit. Also, make sure that the same unit number is not used for more than one CPU Bus Unit.	
The same unit number is assigned to a Special I/O Unit that uses more than one unit number and another Special I/O Unit.		Check whether a Special I/O Unit or CPU Bus Unit that uses more than one unit number is included in the configuration. If there is, check to see if one of the unit numbers assigned to it is used by another Special I/O Unit or CPU Bus Unit. If it is, change the unit number.				
Attached information	Attached information 1: Rack number where error was detected, 0 to 3 Attached information 2: Slot number where error was detected, 0 to 9 Attached information 3: Special I/O Unit: Duplicated unit number + +20 hex CPU Bus Unit: Duplicated unit number + +10 hex					
Precautions/Remarks	Check the model of the Special I/O Unit. Some Special I/O Units use up to four unit numbers.					

*1. For details, refer to *I/O Operation for Major Fault Level Controller Errors* on page 1-23.

Event name	I/O Setting Check Error		Event code	34010000 hex		
Meaning	There is an inconsistency between a Unit model in the Unit Configuration in the CPU Unit and the Unit model that is mounted in the Controller.					
Source	PLC Function Module		Source details	I/O bus master	Detection timing	At power ON, Controller reset, or Unit Configuration and Setup transfer
Error attributes	Level	Major fault	Recovery	Cycle the power supply or reset the Controller.	Log category	System
Effects	User program	Stops.	Operation	Stops. *1		
System-defined variables	Variable	Data type		Name		
	None	---		---		
Cause and correction	Assumed cause		Correction		Prevention	
	A Unit model or Special Unit unit number in the Unit Configuration in the CPU Unit is different from the Unit model or the Special Unit unit number of the Unit that is mounted in the Controller.		Correct the Unit Configuration in the CPU Unit or the physical Unit configuration so that there are no inconsistencies.		Make sure that the Unit Configuration in the CPU Unit and the physical Unit configuration are consistent.	
Attached information	Attached information 1: The lowest slot number where an error was detected on the CPU Rack: 0 to 9, When the CPU Rack is normal: 10 Attached information 2: The lowest slot number where an error was detected on Expansion Rack 1: 0 to 9, When Expansion Rack 1 is normal: 10 Attached information 3: The lowest slot number where an error was detected on Expansion Rack 2: 0 to 9, When Expansion Rack 2 is normal: 10 Attached information 4: The lowest slot number where an error was detected on Expansion Rack 3: 0 to 9, When Expansion Rack 3 is normal: 10					
Precautions/Remarks	None					

*1. For details, refer to *I/O Operation for Major Fault Level Controller Errors* on page 1-23.

Event name	PLC Function Processing Error		Event code	44400000 hex		
Meaning	A fatal error was detected in the PLC Function Module.					
Source	PLC Function Module		Source details	I/O bus master	Detection timing	Continuously
Error attributes	Level	Major fault	Recovery	Cycle the power supply.	Log category	System
Effects	User program	Stops.	Operation	Stops. *1		
System-defined variables	Variable	Data type		Name		
	None	---		---		
Cause and correction	Assumed cause		Correction		Prevention	
	An error occurred in the software.		Contact your OMRON representative.		None	
Attached information	Attached information 1: System information Attached information 2: System information Attached information 3: System information Attached information 4: System information					
Precautions/Remarks	None					

*1. For details, refer to *I/O Operation for Major Fault Level Controller Errors* on page 1-23.

Event name	Impossible to Access Special Unit		Event code	64010000 hex	
Meaning	An error occurred in data exchange between the CPU Unit and a Special Unit.				
Source	PLC Function Module		Source details	CJ-series Unit	Detection timing Continuously
Error attributes	Level	Minor fault	Recovery	Reset error, cycle power supply, or reset Controller.	Log category System
Effects	User program	Continues.	Operation	The Special Unit stops.	
System-defined variables	Variable	Data type		Name	
	None	---		---	
Cause and correction	Assumed cause		Correction		Prevention
	The setting of the rotary switches or a DIP switch pin on a Special Unit is not correct. <ul style="list-style-type: none"> The node address is not correct. The communications mode is not correct. The baud rate is not correct. 		Correct the setting of the rotary switches or DIP switch pin on the Special Unit. You can check the setting error on the seven-segment display on the Special Unit.		Set the rotary switches and DIP switch pins on the Special Units correctly.
	An error occurred in the Special Unit.		Refer to the relevant manual to troubleshoot the error.		Refer to the Unit manual and use the Unit correctly.
	The Unit connection is faulty.		Connect the Unit so that the connectors mate correctly and slide the yellow sliders on the top and on the bottom toward the back to lock them into place.		Make sure that the Units are connected correctly. Check for vibration and shock.
	Noise <ul style="list-style-type: none"> There is data corruption in bus signals. 		If the error did not result from the above causes, cycle the power to the Controller and see if that clears the error. If the error occurs frequently, check the FG, power supply lines, and other noise entry paths, and implement noise countermeasures as required.		Implement noise countermeasures.
A Unit has failed.		If the error did not result from the above causes, and cycling the power to the Controller or resetting the Controller does not clear the error, replace the Special Unit.		Perform regular inspections.	
Attached information	Attached information 1: <ul style="list-style-type: none"> Special I/O Unit: Error unit number +20 hex CPU But Unit: Error unit number +10 hex Attached information 2: System information				
Precautions/Remarks	None				

Event name	CJ-series Unit Backup Failed		Event code	102D0000Hex *1		
Meaning	The backup operation for a CJ-series Unit ended in an error.					
Source	PLC Function Module	Source details	I/O bus master	Detection timing	During backup operation	
Error attributes	Level	Observation	Recovery	---	Log category	System
Effects	User program	Continues.	Operation	Not affected.		
System-defined variables	Variable	Data type		Name		
	None	---		---		
Cause and correction	Assumed cause	Correction		Prevention		
	An error occurred in the Unit Configuration. (when 4 is given for attached information 1 (Error Details))	Eliminate the error in the Unit Configuration.		Back up the data when there are no errors in the Unit Configuration.		
	An error occurred for a Special Unit. (when 2 is given for attached information 1 (Error Details))	Eliminate the error for the Special Unit.		Eliminate the error for the Special Unit.		
	A restart is in progress for the Special Unit. (when 2 is given for attached information 1 (Error Details))	Back up the data when there is no restart command for the Special Unit.		Do not restart the Special Unit when a backup operation is in progress. Do not attempt to back up data during a restart.		
	A Unit model or Special Unit unit number in the Unit Configuration in the CPU Unit is different from the Unit model or the Special Unit unit number of the Unit that is mounted in the Controller. (when 5 is given for attached information 1 (Error Details)).	Correct the Unit Configuration in the CPU Unit or the physical Unit configuration so that there are no inconsistencies.		Make sure that the Unit Configuration in the CPU Unit and the physical Unit configuration are consistent when you back up the data.		
	The CPU Unit or CJ-series Unit has failed. (when 1 is given for attached information 1 (Error Details))	If none of the above causes applies, replace the CPU Unit or the CJ-series Unit.		None		
Attached information	Attached Information 1: Error Details <ul style="list-style-type: none"> • 1: It was not possible to create the backup file. • 2: Communications with a Special Unit failed. • 4: The CJ-series Unit could not be detected. • 5: The Unit Configuration in the CPU Unit and the physical Unit configuration are not consistent. Attached information 2: Rack number where error was detected, 0 to 3 (when 2 is given for Error Details) Attached information 3: Slot number where error was detected, 0 to 9 (when 2 is given for Error Details) Attached information 4: System Information (when 2 is given for Error Details)					
Precautions/Remarks	None					

*1. This event code occurs for unit version 1.03 or later of the CPU Unit.

3 Error Descriptions and Corrections

Event name	CJ-series Unit Restore Operation Failed		Event code	102E0000Hex *1	
Meaning	The restore operation for a CJ-series Unit ended in an error.				
Source	PLC Function Module		Source details	I/O bus master	Detection timing During restore operation
Error attributes	Level	Observation	Recovery	---	Log category System
Effects	User program	---	Operation	Not affected.	
System-defined variables	Variable	Data type		Name	
	None	---		---	
Cause and correction	Assumed cause		Correction		Prevention
	An error occurred in the Unit Configuration. (when 4 is given for attached information 1 (Error Details))		Eliminate the error in the Unit Configuration.		Restore the data when there are no errors in the Unit Configuration.
	An error occurred for a Special Unit. (when 2 is given for attached information 1 (Error Details))		Eliminate the error for the Special Unit.		Restore the data when there are no errors for the Special Unit.
	The Unit Configuration in the backup file does not agree with the physical Unit configuration. (when 5 is given for attached information 1 (Error Details)).		Make sure that the Unit Configuration in the backup file agrees with the physical Unit configuration.		Make sure that Unit Configuration in the backup file agrees with the physical Unit configuration before you attempt to restore the data.
	A restart is in progress for the Special Unit. (when 2 is given for attached information 1 (Error Details))		Restore the data when there is no restart command for the Special Unit.		Do not restart the Special Unit when a restore operation is in progress. Do not attempt to restore data during a restart.
	The restore conditions that are required by the Special Unit are not met. (when 3 is given for attached information 1 (Error Details))		Check the restore conditions in the manual for the Special Unit and make sure that they are met.		Check the restore conditions in the manual for the Special Unit and make sure that they are met.
	The backup files are corrupted. (when 3 is given for attached information 1 (Error Details))		Format the SD Memory Card with the Sysmac Studio and then place the backup file on it.		Do not remove the SD Memory Card or turn OFF the power supply while the SD BUSY indicator is lit. Replace the SD Memory Card periodically according to the write life of the SD Memory Card.
	The CPU Unit or CJ-series Unit has failed. (when 1 is given for attached information 1 (Error Details))		If none of the above causes applies, replace the CPU Unit or the CJ-series Unit.		None
Attached information	Attached Information 1: Error Details <ul style="list-style-type: none"> • 1: It was not possible to read the backup file. • 2: Communications with a Special Unit failed. • 3: The restore operation for a Special Unit failed. • 4: The CJ-series Unit could not be detected. • 5: The Unit Configuration in the backup file does not agree with the physical Unit configuration. Attached information 2: Rack number where error was detected, 0 to 3 (when 2 or 3 is given for Error Details) Attached information 3: Slot number where error was detected, 0 to 9 (when 2 or 3 is given for Error Details) Attached information 4: System Information (when 2 is given for Error Details)				
Precautions/Remarks	None				

*1. This event code occurs for unit version 1.03 or later of the CPU Unit.

Event name	Unsupported Unit Setting		Event code	30200000Hex *1	
Meaning	A setting in the Special Unit is not supported.				
Source	PLC Function Module		Source details	I/O bus master	Detection timing Continuously
Error attributes	Level	Observation	Recovery	---	Log category System
Effects	User program	Continues.	Operation	Not affected.	
System-defined variables	Variable	Data type		Name	
	None	---		---	
Cause and correction	Assumed cause		Correction		Prevention
	A setting in the Special Unit is not supported by the CPU Unit.		Change the setting of the Special Unit where the error occurred so that all Special Unit settings are supported by the CPU Unit.		Refer to the manual for the CPU Unit and use only Special Unit settings that are supported.
Attached information	None				
Precautions/Remarks	None				

*1. This event code occurs for unit version 1.03 or later of the CPU Unit.

Event name	Illegal Packet Discarded		Event code	80010000 hex	
Meaning	An illegal packet was received during message communications. The illegal packet was discarded.				
Source	PLC Function Module		Source details	I/O bus master	Detection timing Continuously
Error attributes	Level	Observation	Recovery	---	Log category System
Effects	User program	Continues.	Operation	Not affected.	
System-defined variables	Variable	Data type		Name	
	None	---		---	
Cause and correction	Assumed cause		Correction		Prevention
	Noise <ul style="list-style-type: none"> There is data corruption in bus signals. 		Cycle the power to the Controller and see if this clears the error. If the error occurs frequently, check the FG, power supply lines, and other noise entry paths, and implement noise countermeasures as required.		Implement noise countermeasures.
Attached information	None				
Precautions/Remarks	None				

Event name	PLC System Information			Event code	04020000 hex	
Meaning	This event provides internal information from the PLC Function Module.					
Source	PLC Function Module		Source details	I/O bus master	Detection timing	Continuously
Error attributes	Level	Information	Recovery	---	Log category	System
Effects	User program	Continues.	Operation	Not affected.		
System-defined variables	Variable		Data type		Name	
	None		---		---	
Cause and correction	Assumed cause		Correction		Prevention	
	This event provides internal information from the PLC Function Module. It is recorded to provide additional information for another event.		---		---	
Attached information	Attached information 1: System information Attached information 2: System information Attached information 3: System information Attached information 4: System information					
Precautions/Remarks	None					

Event name	PLC System Information			Event code	44410000 hex	
Meaning	This event provides internal information from the PLC Function Module.					
Source	PLC Function Module		Source details	I/O bus master	Detection timing	Continuously
Error attributes	Level	Information	Recovery	---	Log category	System
Effects	User program	Continues.	Operation	Not affected.		
System-defined variables	Variable		Data type		Name	
	None		---		---	
Cause and correction	Assumed cause		Correction		Prevention	
	This event provides internal information from the PLC Function Module. It is recorded to provide additional information for another event.		---		---	
Attached information	Attached information 1: System information Attached information 2: System information Attached information 3: System information Attached information 4: System information					
Precautions/Remarks	None					

Built-in I/O and Option Boards

Event name	Option Board Error		Event code	05440000 hex		
Meaning	An Option Board was removed or mounted during operation, or an Option Board hardware error occurred.					
Source	PLC Function Module	Source details	Option Board: Slot1, Slot2	Detection timing	Continuously	
Error attributes	Level	Minor fault	Recovery	Cycle the power supply or reset the Controller.	Log category	System
Effects	User program	Continues.	Operation	Operation is not possible for slots where the error occurred.		
System-defined variables	Variable	Data type		Name		
	_PLC_OptBoardSta	ARRAY[1..2] OF _sOPT-BOARD_STA		Option Board Status		
Cause and correction	Assumed cause	Correction		Prevention		
	An Option Board was removed or mounted during operation.	Turn OFF the power supply to the Controller, then mount the Option Board correctly.		Do not remove or mount Option Boards during operation.		
	A hardware error was detected in an Option Board.	Turn OFF the power supply to the Controller, then mount the Option Board correctly. If this error persists, replace the Option Board in the slot where the error occurred.		None		
Attached information	Attached Information 1: Cause of the error <ul style="list-style-type: none"> • 1. An Option Board was removed during operation. • 2. An Option Board was mounted during operation. • 3. A hardware error was detected in an Option Board. Attached information 2: System information					
Precautions/Remarks	None					

Event name	Option Board Configuration Verification Error		Event code	35940000 hex		
Meaning	The Option Board configuration setup does not agree with the actual configuration.					
Source	PLC Function Module		Source details	Option Board: Slot1, Slot2	Detection timing	At power ON or at download
Error attributes	Level	Minor fault	Recovery	Error reset	Log category	System
Effects	User program	Continues.	Operation	Operation is not possible for slots where the disagreement of configuration occurred.		
System-defined variables	Variable		Data type		Name	
	_PLC_OptBoardSta		ARRAY[1..2] OF _sOPT-BOARD_STA		Option Board Status	
Cause and correction	Assumed cause		Correction		Prevention	
	The Option Board configuration setup does not agree with the actual configuration.		Set up the Option Board configuration or change the actual configuration so that the Option Board configuration setup agrees with the actual configuration. If you change the Option Board configuration setup, download the data to the Controller.		Same as at the left.	
	An Option Board is not mounted correctly.		Turn OFF the power supply to the Controller, then mount the Option Board correctly.		Same as at the left.	
Attached information	None					
Precautions/Remarks	None					

Event name	Unsupported Option Board Mounted		Event code	35950000 hex		
Meaning	There is an unsupported Option Board in the actual configuration.					
Source	PLC Function Module		Source details	Option Board: Slot1, Slot2	Detection timing	At power ON
Error attributes	Level	Minor fault	Recovery	Cycle the power supply or reset the Controller.	Log category	System
Effects	User program	Continues.	Operation	Operation is not possible for slots where the error occurred.		
System-defined variables	Variable		Data type		Name	
	_PLC_OptBoardSta		ARRAY[1..2] OF _sOPT-BOARD_STA		Option Board Status	
Cause and correction	Assumed cause		Correction		Prevention	
	There is an unsupported Option Board in the actual configuration.		Remove the unsupported Option Board.		Use a supported Option Board.	
Attached information	Attached information 1: System information					
Precautions/Remarks	None					

Event name	Analog Option Board Startup Error		Event code	88130000 hex	
Meaning	An error occurred when an Analog Option Board is started.				
Source	PLC Function Module		Source details	Option Board: Slot1, Slot2	Detection timing At power ON
Error attributes	Level	Minor fault	Recovery	Cycle the power supply or reset the Controller.	Log category System
Effects	User program	Continues.	Operation	Operation is not possible for slots where the error occurred.	
System-defined variables	Variable	Data type		Name	
	_PLC_OptBoardSta	ARRAY[1..2] OF _sOPT-BOARD_STA		Option Board Status	
Cause and correction	Assumed cause		Correction		Prevention
	An Analog Option Board is not mounted correctly. Or an Analog Option Board failed.		Turn OFF the power supply to the Controller, then mount the Option Board correctly. If this error persists, replace the Option Board in the slot where the error occurred.		Same as at the left.
Attached information	Attached information 1: System information				
Precautions/Remarks	None				

Event name	Analog Option Board Communications Error		Event code	88140000 hex	
Meaning	A communications error occurred during Analog Option Board operation.				
Source	PLC Function Module		Source details	Option Board: Slot1, Slot2	Detection timing Continuously
Error attributes	Level	Minor fault	Recovery	Cycle the power supply or reset the Controller.	Log category System
Effects	User program	Continues.	Operation	Operation is not possible for slots where the error occurred. Reset the error. Operation is resumed when normal communications are restored.	
System-defined variables	Variable	Data type		Name	
	_PLC_OptBoardSta	ARRAY[1..2] OF _sOPT-BOARD_STA		Option Board Status	
Cause and correction	Assumed cause		Correction		Prevention
	If the indicator on an Analog Option Board flashes, it means that an error occurred in communicating with the Analog Option Board during operation.		Reset the error. If this error occurs even after you reset the error, turn OFF the power supply to the Controller, then mount the Option Board correctly. If this error still occurs, replace the Option Board in the slot where the error occurred.		Same as at the left.
	If the indicator on an Analog Option Board is lit, it means that a WDT error occurred in the Analog Option Board.		Turn OFF the power supply to the Controller, then mount the Option Board correctly. If this error persists, replace the Option Board in the slot where the error occurred.		Same as at the left.
Attached information	Attached information 1: System information				
Precautions/Remarks	None				

Errors Related to Tasks

Event name	Task Execution Timeout		Event code	60020000 hex			
Meaning	Task execution exceeded the timeout detection time.						
Source	PLC Function Module		Source details	None	Detection timing	Continuously	
Error attributes	Level	Major fault	Recovery	Cycle the power supply or reset the Controller.	Log category	System	
Effects	User program	Stops.	Operation	Stops.*1			
System-defined variables	Variable		Data type		Name		
	_<Task_name>_Exceeded		BOOL		Task Period Exceeded Flag		
	_<Task_name>_ExceedCount		UDINT		Task Period Exceeded Count		
	_<Task_name>_LastExecTime		TIME		Last Task Execution Time		
		_<Task_name>_MaxExecTime		TIME		Maximum Task Execution Time	
Cause and correction	Assumed cause		Correction		Prevention		
	The timeout detection time setting is too short.		Increase the timeout detection time.		Design the tasks considering the corrections that are given on the left.		
	The task period setting is too short.		Increase the task period.				
	A user program is too large.		Separate the processes into different tasks, for example move processes that do not need a short execution period to a periodic task with a lower priority.				
	The number of times that processing is repeated is larger than expected.		If there is a program with an extremely high number of repetitions, correct the program to achieve the correct number of repetitions. Set a trap in the user program that monitors the number of times a process is executed to check the number of repetitions.				
	Task Priority Error		Increase the priority of the periodic task. Or, decrease the priorities of the other tasks.				
Frequent Event Task Execution		Lower the frequency of event task execution. Or, decrease the priorities of the event tasks.					
Attached information	Attached Information 1: Name of task where error occurred						
Precautions/Remarks	None						

*1. For details, refer to *I/O Operation for Major Fault Level Controller Errors* on page 1-23.

Event name	I/O Refreshing Timeout Error		Event code	60030000 hex	
Meaning	Consecutive I/O refresh failures occurred during the primary periodic task or periodic task period.				
Source	PLC Function Module		Source details	None	Detection timing Continuously
Error attributes	Level	Major fault	Recovery	Cycle the power supply or reset the Controller.	Log category System
Effects	User program	Stops.	Operation	Stops.*1	
System-defined variables	Variable		Data type		Name
	_<Task_name>_Exceeded		BOOL		Task Period Exceeded Flag
	_<Task_name>_ExceedCount		UDINT		Task Period Exceeded Count
	_<Task_name>_LastExecTime		TIME		Last Task Execution Time
		_<Task_name>_MaxExecTime		Maximum Task Execution Time	
Cause and correction	Assumed cause		Correction		Prevention
	The task period setting is too short.		Check the task execution time and change the task period to an appropriate value.		Design the tasks considering the corrections that are given on the left.
	Task Priority Error for Periodic Tasks and Event Tasks		Increase the priorities of the periodic tasks. Or, decrease the priorities of the event tasks so that they are lower than the priorities of the periodic tasks.		
	There are too many Units and slaves that perform I/O refresh in the task period.		Move the I/O refresh processes to other tasks, for example move I/O refresh processes within the task to other tasks.		
Frequent Event Task Execution		Lower the frequency of event task execution. Or, decrease the priorities of the event tasks.			
Attached information	Attached Information 1: Name of task where error occurred				
Precautions/Remarks	None				

*1. For details, refer to *I/O Operation for Major Fault Level Controller Errors* on page 1-23.

Event name	Insufficient System Service Time Error		Event code	60040000 hex	
Meaning	The specified system service execution time could not be obtained.				
Source	PLC Function Module		Source details	None	Detection timing Continuously
Error attributes	Level	Major fault	Recovery	Cycle the power supply or reset the Controller.	Log category System
Effects	User program	Stops.	Operation	Stops.*1	
System-defined variables	Variable	Data type		Name	
	_ <Task_name> _Exceeded	BOOL		Task Period Exceeded Flag	
	_ <Task_name> _ExceedCount	UDINT		Task Period Exceeded Count	
	_ <Task_name> _LastExecTime	TIME		Last Task Execution Time	
	_ <Task_name> _MaxExecTime	TIME		Maximum Task Execution Time	
Cause and correction	Assumed cause	Correction		Prevention	
	There was not sufficient time to execute the tasks and tag data link service.	Check the available time for task execution and the tag data link settings. Increase the task periods or the packet intervals (RPI) in the tag data link settings to obtain enough time for execution of the tasks and tag data link service.		Set the System Service Monitoring Settings according to the corrections that are given on the left.	
The system service execution interval is too short or the system service execution time ratio is too long in the System Service Monitoring Settings.	Check the effect on the processes executed by the system services with this operation and increase the system service execution interval or reduce the system service execution time ratio.				
Attached information	None				
Precautions/Remarks	None				

*1. For details, refer to *I/O Operation for Major Fault Level Controller Errors* on page 1-23.

Event name	Task Period Exceeded		Event code	60010000 hex	
Meaning	Task execution was not completed during the set task period for the primary periodic task or a periodic task.				
Source	PLC Function Module		Source details	None	Detection timing Continuously
Error attributes	Level	Minor fault	Recovery	Error reset	Log category System
Effects	User program	Continues.	Operation	<p>If the task execution does not finish within the set task period, the I/O refresh operation will be as follows:</p> <ul style="list-style-type: none"> • CJ-series Units: No I/O refresh is executed. When task execution is completed, I/O refreshing for the next period is executed. • EtherCAT slaves, NX Units on the CPU Unit, X Bus Units, Built-in I/O: Outputs: The values from the previous period are output. Inputs: Inputs are refreshed, but the input data is not updated in the executed user program. <p>If the task execution does not finish within the set task period, overall control of the equipment may become impossible.</p>	
System-defined variables	Variable		Data type		Name
	_<Task_name>_Exceeded		BOOL		Task Period Exceeded Flag
	_<Task_name>_ExceedCount		UDINT		Task Period Exceeded Count
	_<Task_name>_LastExecTime		TIME		Last Task Execution Time
Cause and correction	Assumed cause		Correction		Prevention
	The task period setting is too short.		Check the task execution time and change the task period to an appropriate value.		Design the tasks considering the corrections that are given on the left.
	A user program is too large.		Separate the processes into different tasks, for example move processes that need a short execution period to a periodic task with a lower priority.		
	The number of times that processing is repeated is larger than expected.		If there is a program with an extremely high number of repetitions, correct the program to achieve the correct number of repetitions. Set a trap in the user program that monitors the number of times a process is executed to check the number of repetitions.		
	Task Priority Error for Periodic Tasks and Event Tasks		Increase the priorities of the periodic tasks. Or, decrease the priorities of the event tasks so that they are lower than the priorities of the periodic tasks.		
Frequent Event Task Execution		Lower the frequency of event task execution. Or, decrease the priorities of the event tasks.			
Attached information	Attached Information 1: Name of task where error occurred				
Precautions/Remarks	You can change the level of the error to an observation in the task settings.				

Event name	Task Period Exceeded		Event code	60050000 hex	
Meaning	Task execution was not completed during the set task period for the primary periodic task or fixed periodic task.				
Source	PLC Function Module		Source details	None	Detection timing Continuously
Error attributes	Level	Observation	Recovery	---	Log category System
Effects	User program	Continues.	Operation	<p>If the task execution does not finish within the set task period, the I/O refresh operation will be as follows:</p> <ul style="list-style-type: none"> • CJ-series Units: No I/O refresh is executed. When task execution is completed, I/O refreshing for the next period is executed. • EtherCAT slaves, NX Units on the CPU Unit, X Bus Units, Built-in I/O: Outputs: The values from the previous period are output. Inputs: Inputs are refreshed, but the input data is not updated in the executed user program. <p>If the task execution does not finish within the set task period, overall control of the equipment may become impossible.</p>	
System-defined variables	Variable	Data type		Name	
	_ <task_name>_Exceeded</task_name>	BOOL		Task Period Exceeded Flag	
	_ <task_name>_ExceedCount</task_name>	UDINT		Task Period Exceeded Count	
	_ <task_name>_LastExecTime</task_name>	TIME		Last Task Execution Time	
	_ <task_name>_MaxExecTime</task_name>	TIME		Maximum Task Execution Time	
Cause and correction	Assumed cause	Correction		Prevention	
	The task period setting is too short.	Check the task execution time and change the task period to an appropriate value.		Design the tasks considering the corrections that are given on the left.	
	A user program is too large.	Separate the processes into different tasks, for example move processes that need a short execution period to a periodic task with a lower priority.			
	The number of times that processing is repeated is larger than expected.	If there is a program with an extremely high number of repetitions, correct the program to achieve the correct number of repetitions. Set a trap in the user program that monitors the number of times a process is executed to check the number of repetitions.			
	Task Priority Error for Periodic Tasks and Event Tasks	Increase the priorities of the periodic tasks. Or, decrease the priorities of the event tasks so that they are lower than the priorities of the periodic tasks.			
Frequent Event Task Execution	Lower the frequency of event task execution. Or, decrease the priorities of the event tasks.				
Attached information	Attached Information 1: Name of task where error occurred				
Precautions/Remarks	This error can occur if you change the level of the error to an observation in the task settings.				

Errors Related to Controller Operation

Event name	User Program/Controller Configurations and Setup Transfer Error		Event code	10200000 hex	
Meaning	The user program or Controller Configurations and Setup were not transferred correctly.				
Source	PLC Function Module NX Bus Function Module EtherCAT Master Function Module	Source details	None or I/O bus master	Detection timing	At power ON or Controller reset
Error attributes	Level	Major fault	Recovery	Cycle the power supply or reset the Controller.	Log category System
Effects	User program	Stops.	Operation	Stops.*1	
System-defined variables	Variable	Data type		Name	
	None	---		---	
Cause and correction	Assumed cause	Correction		Prevention	
	The user program or Controller Configurations and Setup are not correct because the power supply to the Controller was interrupted during a download of the user program or the Controller Configurations and Setup.	Clear all of memory and then download the project from the Sysmac Studio. If attached information is registered, cycle the power supply to the Controller and then implement the above correction.		Do not turn OFF the power supply to the Controller during a download of the user program or the Controller Configurations and Setup.	
	The user program or Controller Configurations and Setup are not correct because the power supply to the Controller was interrupted during online editing.	If you cannot perform a Clear All Memory operation from the Sysmac Studio, transfer the project to the Controller with a restore operation from an SD Memory Card.		Do not interrupt the power supply to the Controller during online editing.	
	The user program or Controller Configurations and Setup are not correct because the power supply to the Controller was interrupted during a Clear All Memory operation.			Do not interrupt the power supply to the Controller during a Clear All Memory operation.	
	The user program or Controller Configurations and Setup are not correct because the power supply to the Controller was interrupted during a restore operation.			Do not interrupt the power supply to the Controller during a restore operation.	
	The power supply to the Controller is not cycled, although it is required after a Clear All Memory operation.	Cycle the power supply to the Controller and then transfer the project to the Controller.		If you execute Clear All Memory on the Controller containing a downloaded project in the unit version 1.40 or later and then download a project in the unit version earlier than 1.40 on Sysmac Studio lower than 1.29, make sure to cycle the power supply of the Controller after executing the Clear All Memory operation.	
	Non-volatile memory failed.	If the error persists even after you make the above correction, replace the CPU Unit.		None	

Attached information	Attached Information 1: Cause Details <ul style="list-style-type: none"> None: Power was interrupted during a download, during online editing, or during restoration. Downloading/Predownloading: For other causes, the timing of error occurrence (during download or during download preparations) is given.
Precautions/Remarks	None

*1. For details, refer to *I/O Operation for Major Fault Level Controller Errors* on page 1-23.

Event name	Illegal User Program Execution ID		Event code	10210000 hex		
Meaning	The user program execution IDs set in the user program and in the CPU Unit do not match.					
Source	PLC Function Module		Source details	None	Detection timing	At user program download, power ON, or Controller reset
Error attributes	Level	Major fault	Recovery	Cycle the power supply or reset the Controller.	Log category	System
Effects	User program	Stops.	Operation	Stops.*1		
System-defined variables	Variable	Data type		Name		
	None	---		---		
Cause and correction	Assumed cause	Correction		Prevention		
	The user program execution IDs set in the user program and in the CPU Unit do not match.	Set the same user program execution ID in the user program and CPU Unit.		Set the same user program execution ID in the user program and CPU Unit.		
	A user program execution ID is set in the CPU Unit but not in the user program.	If user program execution ID is not set in the user program, clear the user program execution ID set in the CPU Unit by clearing all memory in the CPU Unit.		Keep a record of the user program execution IDs set in the user program and in the CPU Unit. They are not displayed.		
Attached information	None					
Precautions/Remarks	None					

*1. For details, refer to *I/O Operation for Major Fault Level Controller Errors* on page 1-23.

Event name	Illegal User Program		Event code	10240000 hex	
Meaning	The user program is not correct.				
Source	PLC Function Module		Source details	None	Detection timing At download, At power ON, or Controller reset
Error attributes	Level	Major fault	Recovery	Cycle the power supply or reset the Controller.	Log category System
Effects	User program	Stops.	Operation	Stops.* ¹	
System-defined variables	Variable	Data type		Name	
	None	---		---	
Cause and correction	Assumed cause		Correction		Prevention
	There are more than 8 nesting levels for functions or function blocks.		Find the location in the user program with more than 8 nesting levels for functions or function blocks and reduce the number of nesting levels to 8 or fewer. Then, download the user program again.		Write the user program so that there is never more than 8 nesting levels for functions or function blocks. Use the program check on the Sysmac Studio to confirm that there are not more than 8 nesting levels.
Attached information	None				
Precautions/Remarks	None				

*1. For details, refer to *I/O Operation for Major Fault Level Controller Errors* on page 1-23.

Event name	Illegal User Program/Controller Configurations and Setup		Event code	10250000 hex	
Meaning	The upper limit of the usable memory was exceeded or the user program or Controller Configurations and Setup is corrupted.				
Source	PLC Function Module		Source details	None	Detection timing At download, power ON, or Controller reset
Error attributes	Level	Major fault	Recovery	Cycle the power supply or reset the Controller.	Log category System
Effects	User program	Stops.	Operation	Stops.*1	
System-defined variables	Variable	Data type		Name	
	None	---		---	
Cause and correction	Assumed cause		Correction		Prevention
	The upper limit of the data size was exceeded.		If an event on restrictions on the number of items used occurred at the same time as this event*2, correct the user program and settings so that the number of items used is not exceeded and then download the data again.		None
	The main memory capacity was exceeded.		If an event on restrictions on the number of items used did not occur at the same time as this event*2, perform the Clear All Memory operation, cycle the power supply, and then confirm that this event was cleared. If it was cleared, reduce the size of the project, e.g., by sharing programming, and then download the project again.		
Non-volatile memory is deteriorating or has failed.		If this error persists even after you implement the above two corrections, replace the CPU Unit.			
Attached information	None				
Precautions/Remarks	None				

*1. For details, refer to *I/O Operation for Major Fault Level Controller Errors* on page 1-23.

*2. The *Too Many Reset Motion Control Error Instructions*(571D0000 hex) related to item count restrictions occurs only with CPU Unit versions is Ver.1.02 to Ver.1.09.

Event name	Error in Starting Automatic Transfer		Event code	10270000 hex*1	
Meaning	An error was detected in pre-execution checks for automatic transfer.				
Source	PLC Function Module		Source details	None	Detection timing At power ON
Error attributes	Level	Major fault	Recovery	Cycle the power supply or reset the Controller.	Log category System
Effects	User program	Stops.	Operation	Stops.*2	
System-defined variables	Variable	Data type		Name	
	None	---		---	
Cause and correction	Assumed cause		Correction		Prevention
	An SD Memory Card is not inserted.		Insert an SD Memory Card.		Insert an SD Memory Card.
	The SD Memory Card type is not correct.		Replace the SD Memory Card with an SD or SDHC card.		Use an SD or SDHC card.
	The format of the SD Memory Card is not correct.		Format the SD Memory Card with the Sysmac Studio and then create an autoloader folder and place the backup files in it.		Use a formatted SD Memory Card, create an autoloader folder on the SD Memory Card, and place the backup files in it.
	There is no autoloader folder on the SD Memory Card.		Create an autoloader folder on the SD Memory Card and place the backup files in it.		Also, do not remove the SD Memory Card or turn OFF the power supply while the SD BUSY indicator is lit.
	There are no backup files in the autoloader folder on the SD Memory Card.		Place the backup files in the autoloader folder on the SD Memory Card.		
	Either the backup files in the autoloader folder on the SD Memory Card are corrupted or required data is not in the backup files on the SD Memory Card.		Replace the backup files in the autoloader folder on the SD Memory Card. If this error occurs again even after replacing the files, create the backup files again and place them in the autoloader folder.		
	The unit version of the CPU Unit to which to transfer the files is older than the unit version of the backup files on the SD Memory Card.		Replace the CPU Unit with a CPU Unit that has a unit version that is the same as or newer than the unit version of the CPU that was used to create the backup files. Or, place the backup files with the correct unit version for the CPU Unit in the autoloader folder.		Make sure that the unit version of the CPU Unit and the unit version of the backup files are compatible.
	The model of the CPU Unit to which to transfer the files is not the same as the model of the CPU Unit of the backup files on the SD Memory Card.		Replace the CPU Unit with a CPU Unit that has the same model as the CPU Unit that was used to create the backup files. Or, place the backup files with the same model of CPU Unit in the autoloader folder.		Make sure that the model of the CPU Unit is the same as the model of the CPU Unit that was used to create the backup files.
	Recovery was executed for the SD Memory Card.		If there are no backup files or no automatic transfer command file in the autoloader folder, place the files in the folder again.		None
	The CPU Unit is write-protected.		If you use automatic transfers, select the <i>Do not use</i> Option for the Write protection at startup setting of the CPU Unit.		If you use automatic transfers, select the <i>Do not use</i> Option for the Write protection at startup setting of the CPU Unit.

	The settings in the automatic transfer command file (AutoloadCommand.ini) are not correct.	Make sure that the required files are set to "Yes" in the automatic transfer command file.	Make sure that the required files are set to "Yes" in the automatic transfer command file.
	Reading the data for automatic transfer failed because the SD Memory Card is faulty or not formatted correctly.	Perform the same corrective measures as for when the format of the SD Memory Card is not correct or the SD Memory Card is damaged.	Perform the same preventive measures as for the following events: SD Memory Card Invalid Format or Faulty SD Memory Card.
	The SD Memory Card is damaged.	If none of the above causes applies, replace the SD Memory Card.	Do not remove the SD Memory Card or turn OFF the power supply while the SD BUSY indicator is lit. Or, replace the SD Memory Card periodically according to the write life of the SD Memory Card.
	The database connection service version of the CPU Unit to which to transfer the files is older than the database connection service version of the backup files on the SD Memory Card.	Replace the CPU Unit with a CPU Unit that has a database connection service version that is the same as or newer than the database connection service version of the CPU Unit that was used to create the backup files. Or, place the backup files with the correct database connection service version for the CPU Unit in the autoload folder.	Make sure that the database connection service version of the CPU Unit and the database connection service version of the backup files are compatible.
	The robot version of the CPU Unit to which to transfer the files is older than the robot version of the backup files on the SD Memory Card.	Replace the CPU Unit with a CPU Unit that has a robot version that is the same as or newer than the robot version of the CPU Unit that was used to create the backup files. Or, place the backup files with the correct robot version for the CPU Unit in the autoload folder.	Make sure that the robot version of the CPU Unit and the robot version of the backup files are compatible.
	The CPU Unit failed to process the power OFF during the last power interruption.	Contact your OMRON representative or distributor.	None
	An unexpected error has occurred.		
Attached information	<p>Attached Information 1: Error Details</p> <ul style="list-style-type: none"> • 0001 hex: An SD Memory Card is not inserted. • 0002 hex: The SD Memory Card is faulty, the format of the SD Memory Card is not correct, or the SD Memory Card is not the correct type of card. • 0004 hex: Recovery was executed for the SD Memory Card. • 0101 hex: There is no autoload folder on the SD Memory Card. • 0102 hex: There are no backup files in the autoload folder on the SD Memory Card. • 0103 hex: The backup files are corrupted. • 0104 hex: The contents of the automatic transfer command file are not correct. • 0105 hex: The required transfer data is not in the backup file. • 0201 hex: The unit version of the CPU Unit is old. • 0202 hex: The model numbers of the CPU Unit are not the same. • 0203 hex: The CPU Unit is write-protected. • 0209 hex: The CPU Unit failed to process the power OFF during the last power interruption. • 0211 hex: The database connection service or robot version of the CPU Unit is old. • 0301 hex: Reading data for automatic transfer failed or the SD Memory Card is faulty. • 7F01 hex: An unexpected error has occurred. 		
Precautions/Remarks	None		

*1. This event code occurs for unit version 1.03 or later of the CPU Unit.

*2. For details, refer to *I/O Operation for Major Fault Level Controller Errors* on page 1-23.

Event name	Error in Executing Automatic Transfer		Event code	10280000 hex*1		
Meaning	The automatic transfer ended in an error.					
Source	PLC Function Module		Source details	None	Detection timing At power ON	
Error attributes	Level	Major fault	Recovery	Cycle the power supply or reset the Controller.	Log category System	
Effects	User program	Stops.	Operation	Stops.*2		
System-defined variables	Variable	Data type		Name		
	None	---		---		
Cause and correction	Assumed cause		Correction		Prevention	
	It was not possible to read the data for automatic transfer.		Format the SD Memory Card with the Sysmac Studio and then create an autoloader folder and place the backup files in it.		Do not remove the SD Memory Card or turn OFF the power supply while the SD BUSY indicator is lit. Replace the SD Memory Card periodically according to the write life of the SD Memory Card.	
	The SD Memory Card was removed during an automatic transfer.		Insert an SD Memory Card that contains the backup files in an autoloader folder, and then cycle the power supply to execute the automatic transfer again.		Do not remove the SD Memory Card during the automatic transfer.	
	There are no backup files in the autoloader folder on the SD Memory Card.		Create an autoloader folder in the SD Memory Card and store the backup files in it.		Use a formatted SD Memory Card, create an autoloader folder in the SD Memory Card, and store the backup files in the folder.	
	The backup files in the autoloader folder on the SD Memory Card are corrupted.		Store the backup files in the autoloader folder again. If this error occurs again even after replacing the files, create the backup files again and place them in the autoloader folder.		Do not turn OFF the power supply or remove the SD Memory Card while the SD BUSY indicator is lit.	
	The SD Memory Card is damaged.		If none of the above causes applies, replace the SD Memory Card.		Do not remove the SD Memory Card or turn OFF the power supply while the SD BUSY indicator is lit. Replace the SD Memory Card periodically according to the write life of the SD Memory Card.	
	An unexpected error has occurred.		Contact your OMRON representative or distributor.		None	
	Also check the following when you use the Robot Integrated CPU Unit.					
	The SD Memory Card is write protected.		Remove write protection from the SD Memory Card.		Make sure that the SD Memory Card is not write protected.	
	The capacity of the SD Memory Card is insufficient.		Replace the SD Memory Card for one with sufficient available space.		Use an SD Memory Card that has sufficient available space.	
The number of files or directories in the SD Memory Card exceeded the maximum number supported by the file system of the SD Memory Card.		Delete unnecessary files or directories from the SD Memory Card.		Periodically delete unnecessary files and directories on the SD Memory Card.		

	<p>Attached Information 1: Error Details</p> <ul style="list-style-type: none"> • 0001 hex: The SD Memory Card was removed. • 0003 hex: The SD Memory Card is write protected (when the Robot Integrated CPU Unit is used). • 0005 hex: There is not sufficient space available on the SD Memory Card (when the Robot Integrated CPU Unit is used). • 0006 hex: Too many files or directories (when the Robot Integrated CPU Unit is used). • 0102 hex: There are no backup files in the autoload folder on the SD Memory Card. • 0103 hex: The backup files are corrupted. • 0301 hex: Reading data for automatic transfer failed or the SD Memory Card is damaged. • 7F01 hex: An unexpected error has occurred.
Precautions/ Remarks	None

*1. This event code occurs for unit version 1.03 or later of the CPU Unit.

*2. For details, refer to *I/O Operation for Major Fault Level Controller Errors* on page 1-23.

Event name	SD Memory Card Program Transfer Pre-execution Check Error		Event code	10330000 hex ^{*1}		
Meaning	An error was detected in pre-execution checks for transferring SD Memory Card programs.					
Source	PLC Function Module		Source details	None	Detection timing	Before SD Memory Card programs are transferred after a Controller reset
Error attributes	Level	Major fault	Recovery	Cycle the power supply or reset the Controller.	Log category	System
Effects	User program	Stops.	Operation	Stops.*2		
System-defined variables	Variable	Data type		Name		
	_Card1PrgTransferSta	_sPRGTRANSFER_STA		SD Memory Card Program Transfer Status		
Cause and correction	Assumed cause		Correction		Prevention	
	An SD Memory Card is not inserted.		Insert an SD Memory Card.		Insert an SD Memory Card.	
	The SD Memory Card type is not correct.		Replace the SD Memory Card with an SD or SDHC card.		Use an SD or SDHC card.	
	The format of the SD Memory Card is not correct.		Format the SD Memory Card with the Sysmac Studio, create a folder specified by the <i>_Card1PrgTransferCmd.DirName</i> system-defined variable on the card, and store the backup files in the folder.		Use a formatted SD Memory Card, create a folder specified by the <i>_Card1PrgTransferCmd.DirName</i> system-defined variable on the card, and store the backup files in the folder specified by the <i>_Card1PrgTransferCmd.DirName</i> system-defined variable. Also, do not remove the SD Memory Card or turn OFF the power supply while the SD BUSY indicator is lit.	
	There is no such folder on the SD Memory Card as specified by the <i>_Card1PrgTransferCmd.DirName</i> system-defined variable.		Create a folder specified by the <i>_Card1PrgTransferCmd.DirName</i> system-defined variable on the SD Memory Card and store the backup files in the folder.			
	There are no backup files in such a folder on the SD Memory Card as specified by the <i>_Card1PrgTransferCmd.DirName</i> system-defined variable.					
	Either the backup files in the folder specified by the <i>_Card1PrgTransferCmd.DirName</i> system-defined variable on the SD Memory Card are corrupted or required data is not in the backup files on the SD Memory Card.		Replace the backup files in the folder specified by the <i>_Card1PrgTransferCmd.DirName</i> system-defined variable. If this error occurs again even after replacing the files, create the backup files again and place them in the folder specified by the <i>_Card1PrgTransferCmd.DirName</i> system-defined variable.			

The unit version of the CPU Unit to which to transfer the files is older than the unit version of the backup files on the SD Memory Card.	Replace the CPU Unit with a CPU Unit that has a unit version that is the same as or newer than the unit version of the CPU that was used to create the backup files. Or, place the backup files with the correct unit version for the CPU Unit, in the folder specified by the <i>_Card1PrgTransferCmd.DirName</i> system-defined variable.	Make sure that the unit version of the CPU Unit and the unit version of the backup files are compatible.
The model of the CPU Unit to which to transfer the files is not the same as the model of the CPU Unit of the backup files on the SD Memory Card.	Replace the CPU Unit with a CPU Unit that has the same model as the CPU Unit that was used to create the backup files. Or, place the backup files with the correct model for the used CPU Unit, in the folder specified by the <i>_Card1PrgTransferCmd.DirName</i> system-defined variable.	Make sure that the model of the CPU Unit is the same as the model of the CPU Unit that was used to create the backup files.
The CPU Unit is write-protected.	If you transfer SD Memory Card programs, select the <i>Do not use</i> Option for the Write protection at startup setting of the CPU Unit.	If you transfer SD Memory Card programs, select the <i>Do not use</i> Option for the Write protection at startup setting of the CPU Unit.
Required files are not set to transfer in the setting of the <i>_Card1PrgTransferCmd</i> system-defined variable.	Make sure that <i>TRUE</i> is set in the <i>_Card1PrgTransferCmd</i> system-defined variable to transfer required files.	Make sure that <i>TRUE</i> is set in the <i>_Card1PrgTransferCmd</i> system-defined variable to transfer required files.
Reading the data for the SD Memory Card program transfer failed because the SD Memory Card is faulty or not formatted correctly.	Perform the same corrective measures as for when the format of the SD Memory Card is not correct or the SD Memory Card is damaged.	Perform the same preventive measures as for the following events: SD Memory Card Invalid Format or Faulty SD Memory Card.
The SD Memory Card is damaged.	If none of the above causes applies, replace the SD Memory Card.	Do not remove the SD Memory Card or turn OFF the power supply while the SD BUSY indicator is lit. Or, replace the SD Memory Card periodically according to the write life of the SD Memory Card.
The CPU Unit failed to process the power OFF during the last power interruption.	Contact your OMRON representative or distributor.	None
An unexpected error has occurred.		
The database connection service version of the CPU Unit to which to transfer the files is older than the database connection service version of the backup files on the SD Memory Card.	Replace the CPU Unit with a CPU Unit that has the same or a newer database connection service version than the database connection service version of the CPU Unit that was used to create the backup files. Or, place the backup files with the correct database connection service version for the CPU Unit, in the folder specified by the <i>_Card1PrgTransferCmd.DirName</i> system-defined variable.	Make sure that the database connection service version of the CPU Unit and the database connection service version of the backup files are compatible.

	<p>The robot version of the CPU Unit to which to transfer the files is older than the robot version of the backup files on the SD Memory Card.</p>	<p>Replace the CPU Unit with a CPU Unit that has the same or a newer robot version than the robot version of the CPU Unit that was used to create the backup files. Or, place the backup files with the correct robot version for the CPU Unit, in the folder specified by the <code>_Card1PrgTransferCmd.DirName</code> system-defined variable.</p>	<p>Make sure that the robot version of the CPU Unit and the robot version of the backup files are compatible.</p>
<p>Attached information</p>	<p>Attached Information 1: Error Details</p> <ul style="list-style-type: none"> • 0001 hex: An SD Memory Card is not inserted. • 0002 hex: The SD Memory Card is faulty, the format of the SD Memory Card is not correct, or the SD Memory Card is not the correct type of card. • 0004 hex: Recovery was executed for the SD Memory Card. • 0101 hex: There is no such folder on the SD Memory Card as specified by the <code>_Card1PrgTransferCmd.DirName</code> system-defined variable. • 0102 hex: There are no backup files in such a folder on the SD Memory Card as specified by the <code>_Card1PrgTransferCmd.DirName</code> system-defined variable. • 0103 hex: The backup files are corrupted. • 0104 hex: Required files are not set to transfer in the setting of the <code>_Card1PrgTransferCmd</code> system-defined variable. • 0105 hex: The required transfer data is not in the backup file. • 0201 hex: The unit version of the CPU Unit is old. • 0202 hex: The model numbers of the CPU Unit are not the same. • 0203 hex: The CPU Unit is write-protected. • 0209 hex: The CPU Unit failed to process the power OFF during the last power interruption. • 0211 hex: The database connection service or robot version of the CPU Unit is old. • 0214 hex: The DIP switch on the CPU Unit is not set to allow starting the SD Memory Card program transfer. • 0301 hex: Reading data for transferring the programs failed or the SD Memory Card is faulty. • 7F01 hex: An unexpected error has occurred. 		
<p>Precautions/Remarks</p>	<p>None</p>		

*1. This event code occurs for unit version 1.11 or later of the CPU Unit.

*2. For details, refer to *I/O Operation for Major Fault Level Controller Errors* on page 1-23.

Event name	Error in Executing SD Memory Card Program Transfer		Event code	10340000 hex*1	
Meaning	The SD Memory Card program transfer ended in an error.				
Source	PLC Function Module		Source details	None	Detection timing During SD Memory Card program transfers
Error attributes	Level	Major fault	Recovery	Cycle the power supply or reset the Controller.	Log category System
Effects	User program	Stops.	Operation	Stops.*2	
System-defined variables	Variable		Data type		Name
	_Card1PrgTransferSta		_sPRGTRANSFER_STA		SD Memory Card Program Transfer Status
Cause and correction	Assumed cause	Correction		Prevention	
	It was not possible to read the data for SD Memory Card program transfers.	Format the SD Memory Card with the Sysmac Studio, create a folder specified by the <i>_Card1PrgTransferCmd.DirName</i> system-defined variable on the card, and store the backup files in the folder specified by the <i>_Card1PrgTransferCmd.DirName</i> system-defined variable.		Do not remove the SD Memory Card or turn OFF the power supply while the SD BUSY indicator is lit. Or, replace the SD Memory Card periodically according to the write life of the SD Memory Card.	
	The SD Memory Card was removed during a SD Memory Card program transfer.	Insert an SD Memory Card that contains the backup files in the folder specified by the <i>_Card1PrgTransferCmd.DirName</i> system-defined variable, and then cycle the power supply to execute the SD Memory Card program transfer again.		Do not remove the SD Memory Card during the SD Memory Card program transfer.	
	There are no backup files in such a folder on the SD Memory Card as specified by the <i>_Card1PrgTransferCmd.DirName</i> system-defined variable.	Create a folder specified by the <i>_Card1PrgTransferCmd.DirName</i> system-defined variable on the SD Memory Card and store the backup files in the folder.		Use a formatted SD Memory Card, create a folder specified by the <i>_Card1PrgTransferCmd.DirName</i> system-defined variable on the card, and store the backup files in the folder specified by the <i>_Card1PrgTransferCmd.DirName</i> system-defined variable.	
	The backup files in such a folder on the SD Memory Card as specified by the <i>_Card1PrgTransferCmd.DirName</i> system-defined variable are corrupted.	Replace the backup files in the folder specified by the <i>_Card1PrgTransferCmd.DirName</i> system-defined variable. If this error occurs again even after replacing the files, create the backup files again and place them in the folder specified by the <i>_Card1PrgTransferCmd.DirName</i> system-defined variable.		Also, do not remove the SD Memory Card or turn OFF the power supply while the SD BUSY indicator is lit.	
	The SD Memory Card is damaged.	If none of the above causes applies, replace the SD Memory Card.		Do not remove the SD Memory Card or turn OFF the power supply while the SD BUSY indicator is lit. Or, replace the SD Memory Card periodically according to the write life of the SD Memory Card.	
	An unexpected error has occurred.	Contact your OMRON representative or distributor.		None	

	Also check the following when you use the Robot Integrated CPU Unit.		
	The SD Memory Card is write protected.	Remove write protection from the SD Memory Card.	Make sure that the SD Memory Card is not write protected.
	The capacity of the SD Memory Card is insufficient.	Replace the SD Memory Card for one with sufficient available space.	Use an SD Memory Card that has sufficient available space.
	The number of files or directories in the SD Memory Card exceeded the maximum number supported by the file system of the SD Memory Card.	Delete unnecessary files or directories from the SD Memory Card.	Periodically delete unnecessary files and directories on the SD Memory Card.
Attached information	Attached Information 1: Error Details <ul style="list-style-type: none"> • 0001 hex: The SD Memory Card was removed. • 0003 hex: The SD Memory Card is write protected (when the Robot Integrated CPU Unit is used). • 0005 hex: There is not sufficient space available on the SD Memory Card (when the Robot Integrated CPU Unit is used). • 0006 hex: Too many files or directories (when the Robot Integrated CPU Unit is used). • 0102 hex: There are no backup files in such a folder on the SD Memory Card as specified by the <code>_Card1PrgTransferCmd.DirName</code> system-defined variable. • 0103 hex: The backup files are corrupted. • 0301 hex: Reading data for transferring the SD Memory Card programs failed or the SD Memory Card is faulty. • 7F01 hex: An unexpected error has occurred. 		
Precautions/Remarks	None		

*1. This event code occurs for unit version 1.11 or later of the CPU Unit.

*2. For details, refer to *I/O Operation for Major Fault Level Controller Errors* on page 1-23.

Event name	Security anomaly detection		Event code	10650000Hex*1		
Meaning	The system has detected a security anomaly.					
Source	PLC Function Module		Source details	None	Detection timing	Continuously
Error attributes	Level	Major fault	Recovery	Cycle the power supply.	Log category	System
Effects	User program	Stops.	Operation	Stops.*2		
System-defined variables	Variable	Data type		Name		
	None	---		---		
Cause and correction	Assumed cause		Correction		Prevention	
	The system detected a security anomaly.		Contact your OMRON representative.		None	
Attached information	Attached information 1: System information Attached information 2: System information Attached information 3: System information Attached information 4: System information					
Precautions/Remarks	None					

*1. This event code occurs for an NJ-series CPU Unit with unit version 1.69 or later, NX502, NX102, or NX1P2 CPU Unit with unit version 1.70 or later and NX701 CPU Unit with unit version 1.37 or later.

*2. For details, refer to *I/O Operation for Major Fault Level Controller Errors* on page 1-23.

Event name	PLC Function Processing Error			Event code	40110000 hex	
Meaning	A fatal error was detected in the PLC Function Module.					
Source	PLC Function Module		Source details	None	Detection timing	Continuously
Error attributes	Level	Major fault	Recovery	Cycle the power supply.	Log category	System
Effects	User program	Stops.	Operation	Stops.*1		
System-defined variables	Variable		Data type		Name	
	None		---		---	
Cause and correction	Assumed cause		Correction		Prevention	
	An error occurred in the software.		Contact your OMRON representative.		None	
Attached information	Attached information 1: System information Attached information 2: System information Attached information 3: System information Attached information 4: System information					
Precautions/Remarks	None					

*1. For details, refer to *I/O Operation for Major Fault Level Controller Errors* on page 1-23.

Event name	Safe Mode			Event code	40160000 hex*1	
Meaning	The Controller started in Safe Mode.					
Source	PLC Function Module		Source details	None	Detection timing	At power ON, or Controller reset
Error attributes	Level	Major fault	Recovery	Cycle the power supply or reset the Controller.	Log category	System
Effects	User program	Stops.	Operation	Stops.*2		
System-defined variables	Variable		Data type		Name	
	None		---		---	
Cause and correction	Assumed cause		Correction		Prevention	
	The power supply was turned ON to the Controller when Safe Mode was set on the DIP switch on the CPU Unit.		---		---	
Attached information	None					
Precautions/Remarks	If the Controller is started when the CPU Unit is in Safe Mode, the user program is not executed even if the startup mode is set to RUN mode.					

*1. This event code occurs for unit version 1.02 or earlier of the CPU Unit.

*2. For details, refer to *I/O Operation for Major Fault Level Controller Errors* on page 1-23.

3 Error Descriptions and Corrections

Event name	PLC Function Processing Error		Event code	44420000Hex *1	
Meaning	A fatal error was detected in the PLC Function Module.				
Source	PLC Function Module		Source details	None	Detection timing Continuously
Error attributes	Level	Major fault	Recovery	Cycle the power supply or reset the Controller.	Log category System
Effects	User program	Stops.	Operation	Stops.*2	
System-defined variables	Variable	Data type		Name	
	None	---		---	
Cause and correction	Assumed cause		Correction		Prevention
	An error occurred in the software.		Contact your OMRON representative.		None
Attached information	Attached information 1: System information Attached information 2: System information Attached information 3: System information Attached information 4: System information				
Precautions/Remarks	None				

*1. This event code occurs for unit version 1.05 or later of the CPU Unit.

*2. For details, refer to *I/O Operation for Major Fault Level Controller Errors* on page 1-23.

Event name	Automation Playback Startup Error		Event code	35EF0000Hex *1	
Meaning	The automation playback function. cannot be started.				
Source	PLC Function Module		Source details	None	Detection timing When CPU Unit starts running
Error attributes	Level	Minor fault	Recovery	Change the settings to disable automation playback function, and transfer the settings using the synchronization function of Sysmac Studio.	Log category System
Effects	User program	Continues.	Operation	Not affected.	
System-defined variables	Variable	Data type		Name	
	_APB_Status	_sAPB_STATUS		APB Service Status	
Cause and correction	Assumed cause		Correction		Prevention
	Settings to use the automation playback function are made for the CPU Unit that does not support the automation playback function.		Change the settings so that the automation playback function is not used, and transfer the settings from Synchronization of Sysmac Studio.		Use the CPU Unit that supports the automation playback function and configure it to use the automation playback function with it.
Attached information	Attached information 1: CPU Unit model Attached information 2: Unit version of CPU Unit				
Precautions/Remarks	None				

*1. This event code occurs for an NX502 CPU Unit with unit version 1.63 or later.

Event name	PLC Function Processing Error			Event code	40120000 hex	
Meaning	A fatal error was detected in the PLC Function Module.					
Source	PLC Function Module		Source details	None	Detection timing	Continuously
Error attributes	Level	Partial fault	Recovery	Cycle the power supply.	Log category	System
Effects	User program	Stops.	Operation	Stops.*1		
System-defined variables	Variable	Data type		Name		
	None	---		---		
Cause and correction	Assumed cause		Correction		Prevention	
	An error occurred in the software.		Contact your OMRON representative.		None	
Attached information	Attached information 1: System information Attached information 2: System information Attached information 3: System information Attached information 4: System information					
Precautions/Remarks	None					

*1. Operation is the same as for a major fault level error. For details, refer to *I/O Operation for Major Fault Level Controller Errors* on page 1-23.

Event name	PLC Function Processing Error			Event code	40130000 hex	
Meaning	A fatal error was detected in part of the PLC Function Module.					
Source	PLC Function Module		Source details	None	Detection timing	Continuously
Error attributes	Level	Minor fault	Recovery	Cycle the power supply or reset the Controller.	Log category	System
Effects	User program	Continues.	Operation	Not affected.		
System-defined variables	Variable	Data type		Name		
	None	---		---		
Cause and correction	Assumed cause		Correction		Prevention	
	An error occurred in the software.		Contact your OMRON representative.		None	
Attached information	Attached information 1: System information*1 Attached information 2: System information Attached information 3: System information Attached information 4: System information					
Precautions/Remarks	None					

*1. If a *devb-mmcsd* is stored, replace the SD Memory Card and cycle the power supply of the CPU Unit.

Event name	Upper Limit of Variable Sampling		Event code	95770000Hex *1	
Meaning	The upper limit for variable sampling has been reached.				
Source	PLC Function Module		Source details	None	Detection timing When variable sampling starts
Error attributes	Level	Minor fault	Recovery	Change the settings of variables to be collected by the automation playback function and transfer the settings from Synchronization of Sysmac Studio.	Log category System
Effects	User program	Continues.	Operation	Not affected.	
System-defined variables	Variable		Data type	Name	
	_APB_Status		_sAPB_STATUS	APB Service Status	
Cause and correction	Assumed cause		Correction		Prevention
	The maximum number of variable sampling has been reached or size or processing capacity has exceeded the upper limit.		Implement the following modifications and modify the sampling setting so that variable sampling is performed correctly. <ul style="list-style-type: none"> • Reduce program POU's set for collection target. • Set a longer task period time. • Exclude axis variables from sampling (for primary periodic task only). 		Perform collection only for program POU's containing variables that need to be recorded in the variable log.
Attached information	<p>Attached information 1: Task types for which sampling cannot be performed</p> <ul style="list-style-type: none"> • 0: Primary periodic task • 1: Periodic task <p>Attached information 2: Type of factor</p> <ul style="list-style-type: none"> • 0: The total number of variables exceeded the upper limit. • 1: The total size of the variable exceeded the upper limit. • 2: Processing capacity exceeded the upper limit. <p>Attached information 3</p> <ul style="list-style-type: none"> • Attached information 2 is 0: Total number of variables that are set for sampling • Attached information 2 is 1: Total size (bytes) of the variable that is set for sampling • Attached information 2 is 2: Fixed to 0 <p>Attached information 4: Sampling setting number when the error occurred</p>				
Precautions/Remarks	<ul style="list-style-type: none"> • Variable sampling stops. 				

*1. This event code occurs for an NX502 CPU Unit with unit version 1.63 or later earlier than version 1.65.

Event name	Upper Limit of Variable Sampling		Event code	95790000 hex *1	
Meaning	The upper limit for variable sampling has been reached.				
Source	PLC Function Module		Source details	None	Detection timing When variable sampling starts
Error attributes	Level	Minor fault	Recovery	Change the settings of variables to be collected by the automation playback function and transfer the settings from Synchronization of Sysmac Studio.	Log category System
Effects	User program	Continues.	Operation	Not affected.	
System-defined variables	Variable		Data type	Name	
	_APB_Status		_sAPB_STATUS	APB Service Status	
Cause and correction	Assumed cause		Correction		Prevention
	The maximum number of variable sampling has been reached or size or processing capacity has exceeded the upper limit.		Implement the following modifications and modify the sampling setting so that variable sampling is performed correctly. <ul style="list-style-type: none"> • Reduce program POU's set for collection target. • Set a longer task period time. • Exclude axis variables from sampling (for primary periodic task only). 		Perform collection only for program POU's containing variables that need to be recorded in the variable log.
Attached information	Attached information 1: Task types for which sampling cannot be performed <ul style="list-style-type: none"> • 0: Primary periodic task • 1: Periodic task Attached information 2: Type of factor <ul style="list-style-type: none"> • 0: The total number of variables exceeded the upper limit. • 1: The total size of the variable exceeded the upper limit. • 2: Processing capacity exceeded the upper limit. Attached information 3 <ul style="list-style-type: none"> • Attached information 2 is 0: Total number of variables that are set for sampling • Attached information 2 is 1: Total size (KB) of the variable that is set for sampling • Attached information 2 is 2: Fixed to 0 Attached information 4: Sampling setting number when the error occurred				
Precautions/Remarks	<ul style="list-style-type: none"> • Variable sampling stops. • You can change the event level to the observation level. If you change the level to the observation level, recovery procedures are not required. 				

*1. This event code occurs for an NX502 CPU Unit with unit version 1.65 or later.

3 Error Descriptions and Corrections

Event name	Event Log Save Error			Event code	10230000 hex	
Meaning	Saving the event log failed.					
Source	PLC Function Module		Source details	None	Detection timing	At power ON, or Controller reset
Error attributes	Level	Observation	Recovery	---	Log category	System
Effects	User program	Starts.	Operation	Not affected. However, part or all of the past event log cannot be read.		
System-defined variables	Variable	Data type		Name		
	None	---		---		
Cause and correction	Assumed cause		Correction		Prevention	
	A low battery voltage prevented retention of memory during a power interruption. (NJ/NX-series)		Replace the Battery.		Replace the battery periodically.	
	A forced shutdown was performed. (NY-series)		None		Perform a shutdown with other method than the forced shutdown.	
	Data in the event log area are invalid. (NY-series)		If the error persists even after you cycle the power to the Industrial PC, a hardware failure may occur in the event log area. Replace the Industrial PC if you use the event logs in the Industrial PC.		None	
	Data in the event log area are invalid. (NJ/NX-series)		If this error persists even after you cycle the power supply to the CPU Unit, a hardware failure may occur in the event log area. Replace the CPU Unit if you use the event logs in the CPU Unit.		None	
Attached information	Attached Information 1: Error Details <ul style="list-style-type: none"> • 0: Failure to save all categories of logs, • 1: Failure to save system event log, • 2: Failure to save access event log, • 100: Failure to save user-defined event log 					
Precautions/Remarks	None					

Event name	Trace Setting Transfer Failure			Event code	10260000 hex	
Meaning	The power supply was interrupted while transferring the trace settings.					
Source	PLC Function Module		Source details	None	Detection timing	At power ON, or Controller reset
Error attributes	Level	Observation	Recovery	Cycle the power supply or reset the Controller.	Log category	System
Effects	User program	Continues.	Operation	Not affected.		
System-defined variables	Variable	Data type		Name		
	None	---		---		
Cause and correction	Assumed cause		Correction		Prevention	
	The power supply was interrupted while transferring the trace settings.		Transfer the trace settings again.		Do not interrupt the power supply while transferring the trace settings.	
Attached information	None					
Precautions/Remarks	All trace settings are initialized when this error occurs.					

Event name	Backup Failed to Start		Event code	10290000 hex*1	
Meaning	An error was detected in pre-execution checks for a backup operation.				
Source	PLC Function Module		Source details	None	Detection timing When backup is specified by the user
Error attributes	Level	Observation	Recovery	---	Log category System
Effects	User program	Continues.	Operation	Not affected.	
System-defined variables	Variable	Data type		Name	
	None	---		---	
Cause and correction	Assumed cause		Correction		Prevention
	An SD Memory Card is not inserted.		Insert an SD Memory Card.		Insert an SD Memory Card.
	The SD Memory Card type is not correct.		Replace the SD Memory Card with an SD or SDHC card.		Use an SD or SDHC card.
	The format of the SD Memory Card is not correct.		Format the SD Memory Card with the Sysmac Studio.		Use a formatted SD Memory Card. Also, do not remove the SD Memory Card or turn OFF the power supply while the SD BUSY indicator is lit.
	The SD Memory Card is write protected.		Remove write protection from the SD Memory Card.		Make sure that the SD Memory Card is not write protected.
	The Prohibiting backing up data to the SD Memory Card parameter is set to <i>prohibit</i> backing up data to an SD Memory Card.		Change the setting of the Prohibiting backing up data to the SD Memory Card parameter to enable backing up data to an SD Memory Card.		Set the Prohibiting backing up data to the SD Memory Card parameter to enable backing up data to an SD Memory Card.
	Another backup operation is in progress.		Wait for the other backup operation to end and then perform the backup operation again.		Do not attempt to perform other backup operation during a backup operation.
	Synchronization, online editing, or the Clear All Memory operation is in progress.		Wait for the synchronization, online editing, or the Clear All Memory operation to end and then perform the backup operation again.		Do not attempt to perform a backup operation during a synchronization, online editing, or the Clear All Memory operation.
	The backup was canceled by the user.		None		None
	The online connection with the Sysmac Studio was disconnected.		Check the cable connections. Go offline and then go back online and execute the backup again.		Check the cable to see if it is disconnected or broken. Make sure the cable is connected properly.
	The SD Memory Card is damaged.		If none of the above causes applies, replace the SD Memory Card.		Do not remove the SD Memory Card or turn OFF the power supply while the SD BUSY indicator is lit. Replace the SD Memory Card periodically according to the write life of the SD Memory Card.
	An unexpected error has occurred.		Contact your OMRON representative or distributor.		None

Attached information	<p>Attached information 1: Operation type</p> <ul style="list-style-type: none"> • 0101 hex: Controller to SD Memory Card for switch operation on front of CPU Unit • 0102 hex: Controller to SD Memory Card for system variable operation • 0103 hex: Controller to SD Memory Card for instruction from Sysmac Studio or function module specific trigger) • 0104 hex: Controller to SD Memory Card for instruction operation. • 0201 hex: Controller to computer <p>Attached Information 2: Error Details</p> <ul style="list-style-type: none"> • 0001 hex: An SD Memory Card is not inserted. • 0002 hex: The SD Memory Card is faulty, the format of the SD Memory Card is not correct, or the SD Memory Card is not the correct type of card. • 0003 hex: The SD Memory Card is write protected. • 0204 hex: SD Memory Card backup is prohibited. • 0205 hex: Another backup operation is in progress. • 0206 hex: Synchronization, online editing, or the Clear All Memory operation is in progress. • 0207 hex: A prohibited character is used in the directory name that is specified in the system-defined variable. • 0401 hex: The backup was canceled by the user. • 0501 hex: The online connection with the Sysmac Studio was disconnected. • 7F01 hex: An unexpected error has occurred.
Precautions/Remarks	None

*1. This event code occurs for unit version 1.03 or later of the CPU Unit.

Event name	Backup Failed		Event code	102A0000 hex*1		
Meaning	The backup operation ended in an error.					
Source	PLC Function Module		Source details	None	Detection timing During backup operation	
Error attributes	Level	Observation	Recovery	---	Log category System	
Effects	User program	Continues.	Operation	Not affected.		
System-defined variables	Variable	Data type		Name		
	None	---		---		
Cause and correction	Assumed cause		Correction		Prevention	
	The capacity of the SD Memory Card is insufficient.		Replace the SD Memory Card for one with sufficient available space.		Use an SD Memory Card that has sufficient available space.	
	It was not possible to save the data that was specified for backup.		Perform the backup operation again when no data write operation to the CPU Unit is in progress.		Do not write to the CPU Unit when a backup operation is in progress.	
	The SD Memory Card was removed during a backup operation.		Insert an SD Memory Card.		Insert an SD Memory Card.	
	Failed to back up Unit or slave.		Refer to the corrections for the following events: CJ-series Unit Backup Failed (102D0000 hex) or EtherCAT Slave Backup Failed (102F0000 hex).		Refer to the prevention information for the following events: CJ-series Unit Backup Failed (102D0000 hex) or EtherCAT Slave Backup Failed (102F0000 hex).	
	The backup was canceled by the user.		None		None	
	Execution of the Save Cam Table instruction or changing the CPU Unit name is in progress.		Perform the operation after execution of the Save Cam Table instruction or changing the CPU Unit name is completed.		Do not perform a backup during execution of the Save Cam Table instruction or while changing the CPU Unit name.	
	The online connection with the Sysmac Studio was disconnected.		Check the cable connections. Go offline and then go back online and execute the backup again.		Check the cable to see if it is disconnected or broken. Make sure the cable is connected properly.	
	It was not possible to save the data that was specified for backup to the computer.		Increase the available space on the hard disk on the computer.		Make sure there is sufficient space available on the hard disk before you perform a backup.	
	The SD Memory Card is damaged.		If none of the above causes applies, replace the SD Memory Card.		Do not remove the SD Memory Card or turn OFF the power supply while the SD BUSY indicator is lit. Replace the SD Memory Card periodically according to the write life of the SD Memory Card.	
	An unexpected error has occurred.		Contact your OMRON representative or distributor.		None	
	Also check the following when you use the Robot Integrated CPU Unit.					
	The SD Memory Card format is invalid		Format the SD Memory Card with the Sysmac Studio.		Use a formatted SD Memory Card.	
	The SD Memory Card is write protected.		Remove write protection from the SD Memory Card.		Make sure that the SD Memory Card is not write protected.	
The /D folder, which is the data to be backed up, does not exist on the SD Memory Card.		Cycle the power supply of the CPU Unit to return the /D folder to the factory default or download the project from the Sysmac Studio.		Do not delete the /D folder from the SD Memory Card.		

Attached information	<p>Attached information 1: Operation type</p> <ul style="list-style-type: none"> • 0101 hex: Controller to SD Memory Card for switch operation on front of CPU Unit • 0102 hex: Controller to SD Memory Card for system variable operation • 0103 hex: Controller to SD Memory Card for instruction from Sysmac Studio or function module specific trigger) • 0104 hex: Controller to SD Memory Card for instruction operation. • 0201 hex: Controller to computer <p>Attached Information 2: Error Details</p> <ul style="list-style-type: none"> • 0001 hex: The SD Memory Card was removed. • 0001 hex: The SD Memory Card is removed or the format is invalid (in the case that the Robot Integrated CPU Unit is used and operation type is 0201 hex). • 0003 hex: The SD Memory Card is write protected (when the Robot Integrated CPU Unit is used). • 0005 hex: There is not sufficient space available on the SD Memory Card. • 0006 hex: Too many files or directories. • 0106 hex: The /D cannot be found in the SD Memory Card (when the Robot Integrated CPU Unit is used). • 0206 hex: Execution of the Save Cam Table instruction or changing the CPU Unit name is in progress. • 00210 hex: A file already exists with the same name as one of the specified directory. • 0302 hex: Saving the backup data failed or the SD Memory Card is faulty. • 0304 hex: The Unit or slave could not be backed up. • 0401 hex: The backup was canceled by the user. • 0501 hex: The online connection with the Sysmac Studio was disconnected. • 0502 hex: It was not possible to save the data that was specified for backup to the computer. • 7F01 hex: An unexpected error has occurred.
Precautions/Remarks	<p>None</p>

*1. This event code occurs for unit version 1.03 or later of the CPU Unit.

Event name	Restore Operation Failed to Start		Event code	102B0000 hex*1		
Meaning	An error was detected in pre-execution checks for a restore operation.					
Source	PLC Function Module	Source details	None	Detection timing	When restoring data is specified by the user	
Error attributes	Level	Observation	Recovery	---	Log category	System
Effects	User program	---	Operation	Not affected.		
System-defined variables	Variable	Data type		Name		
	Specification with system-defined variables					
	_Card1RestoreSta	_sRESTORE_STA		SD Memory Card Restore Status		
Cause and correction	Assumed cause		Correction		Prevention	
	An SD Memory Card is not inserted.		Insert an SD Memory Card.		Insert an SD Memory Card.	
	The SD Memory Card type is not correct.		Replace the SD Memory Card with an SD or SDHC card.		Use an SD or SDHC card.	
	The format of the SD Memory Card is not correct.		Format the SD Memory Card with the Sysmac Studio and then place the backup file on it.		Use a formatted SD Memory Card and place the backup files on it. Also, do not remove the SD Memory Card or turn OFF the power supply while the SD BUSY indicator is lit.	
	There are no backup files on the SD Memory Card.		Place the backup files in the specified folder on the SD Memory Card.			
	Either the backup files on the SD Memory Card are corrupted or required data is not in the backup files on the SD Memory Card.		Create the backup files again.			
	The unit version of the CPU Unit to which to restore the files is older than the unit version of the backup files on the SD Memory Card.		Replace the CPU Unit with a CPU Unit that has a unit version that is the same as or newer than the unit version of the CPU Unit that was used to create the backup files. Or, specify backup files with the correct unit version for the CPU Unit.		Make sure that the unit version of the CPU Unit and the unit version of the backup files are compatible.	
	The model of the CPU Unit to which to restore the files is not the same as the model of the CPU Unit of the backup files on the SD Memory Card.		Replace the CPU Unit with a CPU Unit that has the same model as the CPU Unit that was used to create the backup files. Or, specify backup files with the correct model for the CPU Unit.		Make sure that the model of the CPU Unit is the same as the model of the CPU Unit that was used to create the backup files.	
	Recovery was executed for the SD Memory Card.		If there are no backup files or no restore command file in the specified folder on the SD Memory Card, place the files in the folder again.		None	
	The CPU Unit is write-protected.		If you use the restore function, select the <i>Do not use</i> Option for the Write protection at startup setting of the CPU Unit.		If you use the restore function, select the <i>Do not use</i> Option for the Write protection at startup setting of the CPU Unit.	
The settings in the restore command file (RestoreCommand.ini) are not correct.		Make sure that the required files are set to "Yes" in the restore command file.		Make sure that the required files are set to "Yes" in the restore command file.		
A backup operation is in progress.		Wait for the backup operation to end and then perform the restore operation again.		Do not attempt to perform a restore operation during a backup operation.		

Synchronization, online editing, or the Clear All Memory operation is in progress.	Wait for the synchronization, online editing, or the Clear All Memory operation to end and then perform the restore operation again.	Do not attempt to perform a restore operation during a synchronization, online editing, or the Clear All Memory operation.
The online connection with the Sysmac Studio was disconnected.	Check the cable connections. Go offline and then go back online and execute the backup again.	Check the cable to see if it is disconnected or broken. Make sure the cable is connected properly.
Reading the data for restoration failed because the SD Memory Card is faulty or not formatted correctly.	Perform the same corrective measures as for when the format of the SD Memory Card is not correct or the SD Memory Card is damaged.	Perform the same preventive measures as for the following events: SD Memory Card Invalid Format or Faulty SD Memory Card.
The SD Memory Card is damaged.	If none of the above causes applies, replace the SD Memory Card.	Do not remove the SD Memory Card or turn OFF the power supply while the SD BUSY indicator is lit. Replace the SD Memory Card periodically according to the write life of the SD Memory Card.
The database connection service version of the CPU Unit to which to restore the files is older than the database connection service version of the backup files on the SD Memory Card.	Replace the CPU Unit with a CPU Unit that has a database connection service version that is the same as or newer than the database connection service version of the CPU Unit that was used to create the backup files. Or, specify backup files with the correct database connection service version for the CPU Unit.	Make sure that the database connection service version of the CPU Unit and the database connection service version of the backup files are compatible.
The robot version of the CPU Unit to which to restore the files is older than the robot version of the backup files on the SD Memory Card.	Replace the CPU Unit with a CPU Unit that has a robot version that is the same as or newer than the robot version of the CPU Unit that was used to create the backup files. Or, specify backup files with the correct robot version for the CPU Unit.	Make sure that the robot version of the CPU Unit and the robot version of the backup files are compatible.
The CPU Unit failed to process the power OFF during the last power interruption.	Contact your OMRON representative or distributor.	None
An unexpected error has occurred.		
Check the followings for specification with system-defined variables.		
Restore by system-defined variable is set to Do not use in the Controller Setup.	Set Restore by system-defined variable to Use in the Controller Setup.	Set Restore by system-defined variable to Use in the Controller Setup.
Password of Restore by system-defined variable in the Controller Setup does not agree with the _Card1RestoreCmd.Password system-defined variable.	Set Password of Restore by system-defined variable in the Controller Setup to the _Card1RestoreCmd.Password system-defined variable.	Set Password of Restore by system-defined variable in the Controller Setup to the _Card1RestoreCmd.Password system-defined variable.
The DIP switch on the CPU Unit is not set to allow starting the restore of SD Memory Card backups by specification with system-defined variables.	Turn OFF all pins on the DIP switch of the CPU Unit, and then start the restore of SD Memory Card backups by specification with system-defined variables.	Turn OFF all pins on the DIP switch of the CPU Unit, and then start the restore of SD Memory Card backups by specification with system-defined variables.
There is no such folder as specified by the system-defined variable.	Create a folder specified by the system-defined variable and store the backup files in the folder.	Create a folder specified by the system-defined variable and store the backup files in the folder.

	Required files are not set to transfer in the setting of the system-defined variable.	Make sure that TRUE is set in the system-defined variable to transfer required files.	Make sure that TRUE is set in the system-defined variable to transfer required files.
	Also check the following when you use the Robot Integrated CPU Unit.		
	The SD Memory Card is write protected.	Remove write protection from the SD Memory Card.	Make sure that the SD Memory Card is not write protected.
	The capacity of the SD Memory Card is insufficient.	Replace the SD Memory Card for one with sufficient available space.	Use an SD Memory Card that has sufficient available space.
Attached information	<p>Attached information 1: Operation type</p> <ul style="list-style-type: none"> • 0101 hex: SD Memory Card to Controller for switch operation on front of CPU Unit • 0102 hex: SD Memory Card to Controller for specification with a system-defined variable • 0201 hex: Computer to Controller <p>Attached Information 2: Error Details</p> <ul style="list-style-type: none"> • 0001 hex: An SD Memory Card is not inserted. • 0002 hex: The SD Memory Card is faulty, the format of the SD Memory Card is not correct, or the SD Memory Card is not the correct type of card. • 0003 hex: The SD Memory Card is write protected (when the Robot Integrated CPU Unit is used). • 0004 hex: Recovery was executed for the SD Memory Card. • 0005 hex: There is not sufficient space available on the SD Memory Card (when the Robot Integrated CPU Unit is used). • 0101 hex: There is no such folder on the SD Memory Card as specified by the <code>_Card1RestoreCmd.DirName</code> system-defined variable. • 0102 hex: There are no backup files. • 0103 hex: The backup files are corrupted. • 0104 hex: The contents of the restore command file are not correct or required files are not set to transfer in the setting of the system-defined variable. • 0105 hex: The required transfer data is not in the backup file. • 0201 hex: The unit version of the CPU Unit is old. • 0202 hex: The model numbers of the CPU Unit are not the same. • 0203 hex: The CPU Unit is write-protected. • 0205 hex: Another backup operation is in progress. • 0206 hex: Synchronization, online editing, or the Clear All Memory operation is in progress. • 0209 hex: The CPU Unit failed to process the power OFF during the last power interruption. • 0211 hex: The database connection service or robot version of the CPU Unit is old. • 0212 hex: Restore by system-defined variable is set to Do not use in the Controller Setup. • 0213 hex: Password of Restore by system-defined variable in the Controller Setup does not agree with the <code>_Card1RestoreCmd.Password</code> system-defined variable. • 0214 hex: The DIP switch on the CPU Unit is not set to allow starting the restore of SD Memory Card backups by specification with system-defined variables. • 0301 hex: Reading data for restoration failed or the SD Memory Card is faulty. • 0501 hex: The online connection with the Sysmac Studio was disconnected. • 7F01 hex: An unexpected error has occurred. 		
Precautions/Remarks	None		

*1. This event code occurs for unit version 1.03 or later of the CPU Unit.

Event name	Restore Operation Failed		Event code	102C0000 hex*1	
Meaning	The restore operation ended in an error.				
Source	PLC Function Module		Source details	None	Detection timing During restore operation
Error attributes	Level	Observation	Recovery	---	Log category System
Effects	User program	---	Operation	Not affected.	
System-defined variables	Variable	Data type		Name	
	_Card1RestoreSta	_sRESTORE_STA		SD Memory Card Restore Status	
Cause and correction	Assumed cause		Correction		Prevention
	It was not possible to read the data to restore.		Format the SD Memory Card with the Sysmac Studio and then place the backup files on it.		Do not remove the SD Memory Card or turn OFF the power supply while the SD BUSY indicator is lit. Replace the SD Memory Card periodically according to the write life of the SD Memory Card.
	The SD Memory Card was removed during a restore operation.		Insert an SD Memory Card that contains the backup files, and then execute the restore operation again.		Do not remove the SD Memory Card during the restore operation.
	Failed to restore Unit or slave.		Refer to the corrections for the following events: CJ-series Unit Restore Operation Failed (102E0000 hex) or EtherCAT Slave Restore Operation Failed (10300000 hex).		Refer to the prevention information for the following events: CJ-series Unit Restore Operation Failed (102E0000 hex) or EtherCAT Slave Restore Operation Failed (10300000 hex).
	The SD Memory Card is damaged.		If none of the above causes applies, replace the SD Memory Card.		Do not remove the SD Memory Card or turn OFF the power supply while the SD BUSY indicator is lit. Replace the SD Memory Card periodically according to the write life of the SD Memory Card.
	An unexpected error has occurred.		Contact your OMRON representative or distributor.		None
	Also check the following when you use the Robot Integrated CPU Unit.				
	The SD Memory Card is write protected.		Remove write protection from the SD Memory Card.		Make sure that the SD Memory Card is not write protected.
	The capacity of the SD Memory Card is insufficient.		Replace the SD Memory Card for one with sufficient available space.		Use an SD Memory Card that has sufficient available space.
	The number of files or directories in the SD Memory Card exceeded the maximum number supported by the file system of the SD Memory Card.		Delete unnecessary files or directories from the SD Memory Card.		Periodically delete unnecessary files and directories on the SD Memory Card.

Attached information	<p>Attached information 1: Operation type</p> <ul style="list-style-type: none"> • 0101 hex: SD Memory Card to Controller for switch operation on front of CPU Unit • 0102 hex: SD Memory Card to Controller for specification with a system-defined variable • 0201 hex: Computer to Controller <p>Attached Information 2: Error Details</p> <ul style="list-style-type: none"> • 0001 hex: The SD Memory Card was removed. • 0003 hex: The SD Memory Card is write protected (when the Robot Integrated CPU Unit is used). • 0005 hex: There is not sufficient space available on the SD Memory Card (when the Robot Integrated CPU Unit is used). • 0006 hex: Too many files or directories (when the Robot Integrated CPU Unit is used). • 0102 hex: There are no backup files. • 0103 hex: The backup files are corrupted. • 0301 hex: Reading data for restoration failed or the SD Memory Card is faulty. • 0303 hex: The Unit or slave could not be restored. • 7F01 hex: An unexpected error has occurred.
Precautions/Remarks	None

*1. This event code occurs for unit version 1.03 or later of the CPU Unit.

Event name	SD Memory Card Program Transfer Failed to Start		Event code	10320000 hex ^{*1}	
Meaning	An error was detected in pre-start checks for transferring SD Memory Card programs.				
Source	PLC Function Module		Source details	None	Detection timing When transferring SD Memory Card programs is started
Error attributes	Level	Observation	Recovery	---	Log category System
Effects	User program	---	Operation	Not affected.	
System-defined variables	Variable	Data type		Name	
	_Card1PrgTransferSta	_sPRGTRANSFER_STA		SD Memory Card Program Transfer Status	
Cause and correction	Assumed cause	Correction		Prevention	
	Program transfer by system-defined variable is set to Do not use in the Controller Setup.	Set Program transfer by system-defined variable to Use in the Controller Setup.		Set Program transfer by system-defined variable to Use in the Controller Setup.	
	Password of Program transfer by system-defined variable in the Controller Setup does not agree with the _Card1PrgTransferCmd.Password system-defined variable.	Set Password of Program transfer by system-defined variable in the Controller Setup to the _Card1PrgTransferCmd.Password system-defined variable.		Set Password of Program transfer by system-defined variable in the Controller Setup to the _Card1PrgTransferCmd.Password system-defined variable.	
	The DIP switch on the CPU Unit is not set to allow starting the SD Memory Card program transfer.	Turn OFF all pins on the DIP switch of the CPU Unit, and then start the SD Memory Card program transfer.		Turn OFF all pins on the DIP switch of the CPU Unit, and then start the SD Memory Card program transfer.	
	An SD Memory Card is not inserted.	Insert an SD Memory Card.		Insert an SD Memory Card.	
	The SD Memory Card type is not correct.	Replace the SD Memory Card with an SD or SDHC card.		Use an SD or SDHC card.	
	The format of the SD Memory Card is not correct.	Format the SD Memory Card with the Sysmac Studio, create a folder specified by the _Card1PrgTransferCmd.DirName system-defined variable on the card, and store the backup files in the folder.		Use a formatted SD Memory Card, create a folder specified by the _Card1PrgTransferCmd.DirName system-defined variable on the card, and store the backup files in the folder specified by the _Card1PrgTransferCmd.DirName system-defined variable. Also, do not remove the SD Memory Card or turn OFF the power supply while the SD BUSY indicator is lit.	
	There is no such folder on the SD Memory Card as specified by the _Card1PrgTransferCmd.DirName system-defined variable.	Create a folder specified by the _Card1PrgTransferCmd.DirName system-defined variable on the SD Memory Card and store the backup files in the folder.			
	There are no backup files in such a folder on the SD Memory Card as specified by the _Card1PrgTransferCmd.DirName system-defined variable.				
	Either the backup files in the folder specified by the _Card1PrgTransferCmd.DirName system-defined variable on the SD Memory Card are corrupted or required data is not in the backup files on the SD Memory Card.	Replace the backup files in the folder specified by the _Card1PrgTransferCmd.DirName system-defined variable. If this error occurs again even after replacing the files, create the backup files again and place them in the folder specified by the _Card1PrgTransferCmd.DirName system-defined variable.			

The unit version of the CPU Unit to which to transfer the files is older than the unit version of the backup files on the SD Memory Card.	Replace the CPU Unit with a CPU Unit that has a unit version that is the same as or newer than the unit version of the CPU Unit that was used to create the backup files. Or, place the backup files with the correct unit version for the CPU Unit, in the folder specified by the <code>_Card1PrgTransferCmd.DirName</code> system-defined variable.	Make sure that the unit version of the CPU Unit and the unit version of the backup files are compatible.
The model of the CPU Unit to which to transfer the files is not the same as the model of the CPU Unit of the backup files on the SD Memory Card.	Replace the CPU Unit with a CPU Unit that has the same model as the CPU Unit that was used to create the backup files. Or, place the backup files with the correct model for the used CPU Unit, in the folder specified by the <code>_Card1PrgTransferCmd.DirName</code> system-defined variable.	Make sure that the model of the CPU Unit is the same as the model of the CPU Unit that was used to create the backup files.
The CPU Unit is write-protected.	If you transfer SD Memory Card programs, select the <i>Do not use</i> Option for the Write protection at startup setting of the CPU Unit.	If you transfer SD Memory Card programs, select the <i>Do not use</i> Option for the Write protection at startup setting of the CPU Unit.
Another backup operation is in progress.	Wait for the other backup operation to end and then perform the backup operation again.	Do not attempt to perform other backup operation during a backup operation.
Synchronization, online editing, or the Clear All Memory operation is in progress.	Wait for the synchronization, online editing, or the Clear All Memory operation to end and then perform the backup operation again.	Do not attempt to perform a backup operation during a synchronization, online editing, or the Clear All Memory operation.
Required files are not set to transfer in the setting of the <code>_Card1PrgTransferCmd</code> system-defined variable.	Make sure that <code>TRUE</code> is set in the <code>_Card1PrgTransferCmd</code> system-defined variable to transfer required files.	Make sure that <code>TRUE</code> is set in the <code>_Card1PrgTransferCmd</code> system-defined variable to transfer required files.
Reading the data for the SD Memory Card program transfer failed because the SD Memory Card is faulty or not formatted correctly.	Perform the same corrective measures as for when the format of the SD Memory Card is not correct or the SD Memory Card is damaged.	Perform the same preventive measures as for the following events: SD Memory Card Invalid Format or Faulty SD Memory Card.
The SD Memory Card is damaged.	If none of the above causes applies, replace the SD Memory Card.	Do not remove the SD Memory Card or turn OFF the power supply while the SD BUSY indicator is lit. Or, replace the SD Memory Card periodically according to the write life of the SD Memory Card.
The CPU Unit failed to process the power OFF during the last power interruption.	Contact your OMRON representative or distributor.	None
An unexpected error has occurred.		

	<p>The database connection service version of the CPU Unit to which to transfer the files is older than the database connection service version of the backup files on the SD Memory Card.</p>	<p>Replace the CPU Unit with a CPU Unit that has the same or a newer database connection service version than the database connection service version of the CPU Unit that was used to create the backup files.</p> <p>Or, place the backup files with the correct database connection service version for the CPU Unit, in the folder specified by the <i>_Card1PrgTransferCmd.DirName</i> system-defined variable.</p>	<p>Make sure that the database connection service version of the CPU Unit and the database connection service version of the backup files are compatible.</p>
	<p>The robot version of the CPU Unit to which to transfer the files is older than the robot version of the backup files on the SD Memory Card.</p>	<p>Replace the CPU Unit with a CPU Unit that has the same or a newer robot version than the robot version of the CPU Unit that was used to create the backup files.</p> <p>Or, place the backup files with the correct robot version for the CPU Unit, in the folder specified by the <i>_Card1PrgTransferCmd.DirName</i> system-defined variable.</p>	<p>Make sure that the robot version of the CPU Unit and the robot version of the backup files are compatible.</p>
<p>Attached information</p>	<p>Attached Information 1: Error Details</p> <ul style="list-style-type: none"> • 0001 hex: An SD Memory Card is not inserted. • 0002 hex: The SD Memory Card is faulty, the format of the SD Memory Card is not correct, or the SD Memory Card is not the correct type of card. • 0004 hex: Recovery was executed for the SD Memory Card. • 0101 hex: There is no such folder on the SD Memory Card as specified by the <i>_Card1PrgTransferCmd.DirName</i> system-defined variable. • 0102 hex: There are no backup files in such a folder on the SD Memory Card as specified by the <i>_Card1PrgTransferCmd.DirName</i> system-defined variable. • 0103 hex: The backup files are corrupted. • 0104 hex: Required files are not set to transfer in the setting of the <i>_Card1PrgTransferCmd</i> system-defined variable. • 0105 hex: The required transfer data is not in the backup file. • 0201 hex: The unit version of the CPU Unit is old. • 0202 hex: The model numbers of the CPU Unit are not the same. • 0203 hex: The CPU Unit is write-protected. • 0205 hex: Another backup operation is in progress. • 0206 hex: Synchronization, online editing, or the Clear All Memory operation is in progress. • 0209 hex: The CPU Unit failed to process the power OFF during the last power interruption. • 0211 hex: The database connection service or robot version of the CPU Unit is old. • 0212 hex: Program transfer by system-defined variable is set to Do not use in the Controller Setup. • 0213 hex: Password of Program transfer by system-defined variable in the Controller Setup does not agree with the <i>_Card1PrgTransferCmd.Password</i> system-defined variable. • 0214 hex: The DIP switch on the CPU Unit is not set to allow starting the SD Memory Card program transfer. • 0301 hex: Reading data for transferring the programs failed or the SD Memory Card is faulty. • 7F01 hex: An unexpected error has occurred. 		
<p>Precautions/Remarks</p>	<p>None</p>		

*1. This event code occurs for unit version 1.11 or later of the CPU Unit.

Event name	Restore Pre-execution Check Failure		Event code	103E0000 hex*1		
Meaning	An error was detected in pre-execution checks for specification with system-defined variables for the SD Memory Card restore operation.					
Source	PLC Function Module	Source details	None	Detection timing	Before the restore operation after a Controller reset in Restore by system-defined variable	
Error attributes	Level	Observation	Recovery	---	Log category	System
Effects	User program	Continues.	Operation	Not affected.		
System-defined variables	Variable	Data type		Name		
	_Card1RestoreSta	_sRESTORE_STA		SD Memory Card Restore Status		
Cause and correction	Assumed cause		Correction		Prevention	
	An SD Memory Card is not inserted.		Insert an SD Memory Card.		Insert an SD Memory Card.	
	The SD Memory Card type is not correct.		Replace the SD Memory Card with an SD or SDHC card.		Use an SD or SDHC card.	
	The format of the SD Memory Card is not correct.		Format the SD Memory Card with the Sysmac Studio, create a folder specified by the _Card1RestoreCmd.DirName system-defined variable on the card, and store the backup files in the folder.		Use a formatted SD Memory Card, create a folder specified by the _Card1RestoreCmd.DirName system-defined variable on the card, and store the backup files in the folder.	
	There is no such folder on the SD Memory Card as specified by the _Card1RestoreCmd.DirName system-defined variable.		Create a folder specified by the _Card1RestoreCmd.DirName system-defined variable on the SD Memory Card and store the backup files in the folder.		Also, do not remove the SD Memory Card or turn OFF the power supply while the SD BUSY indicator is lit.	
	There are no backup files in such a folder on the SD Memory Card as specified by the _Card1RestoreCmd.DirName system-defined variable.					
	Either the backup files in the folder specified by the _Card1RestoreCmd.DirName system-defined variable on the SD Memory Card are corrupted or required data is not in the backup files on the SD Memory Card.		Replace the backup files in the folder specified by the _Card1RestoreCmd.DirName system-defined variable. If this error occurs again even after replacing the files, create the backup files again and place them in the folder specified by the _Card1RestoreCmd.DirName system-defined variable.			
	The unit version of the CPU Unit to which to transfer the files is older than the unit version of the backup files on the SD Memory Card.		Replace the CPU Unit with a CPU Unit that has a unit version that is the same as or newer than the unit version of the CPU Unit that was used to create the backup files. Or, place the backup files with the correct unit version for the CPU Unit, in the folder specified by the _Card1RestoreCmd.DirName system-defined variable.		Make sure that the unit version of the CPU Unit and the unit version of the backup files are compatible.	

The model of the CPU Unit to which to transfer the files is not the same as the model of the CPU Unit of the backup files on the SD Memory Card.	Replace the CPU Unit with a CPU Unit that has the same model as the CPU Unit that was used to create the backup files. Or, place the backup files with the correct model for the used CPU Unit, in the folder specified by the <code>_Card1RestoreCmd.DirName</code> system-defined variable.	Make sure that the model of the CPU Unit is the same as the model of the CPU Unit that was used to create the backup files.
The CPU Unit is write-protected.	If you transfer SD Memory Card programs, select the Do not use Option for the Write protection at startup setting of the CPU Unit.	If you transfer SD Memory Card programs, select the Do not use Option for the Write protection at startup setting of the CPU Unit.
Required files are not set to transfer in the setting of the system-defined variable.	Make sure that TRUE is set in the system-defined variable to transfer required files.	Make sure that TRUE is set in the system-defined variable to transfer required files.
Reading the data for the SD Memory Card program transfer failed because the SD Memory Card is faulty or not formatted correctly.	Perform the same corrective measures as for when the format of the SD Memory Card is not correct or the SD Memory Card is damaged.	Perform the same preventive measures as for the following events: SD Memory Card Invalid Format or Faulty SD Memory Card.
The SD Memory Card is damaged.	If none of the above causes applies, replace the SD Memory Card.	Do not remove the SD Memory Card or turn OFF the power supply while the SD BUSY indicator is lit. Or, replace the SD Memory Card periodically according to the write life of the SD Memory Card.
The CPU Unit failed to process the power OFF during the last power interruption.	Contact your OMRON representative or distributor.	None
An unexpected error has occurred.		
The database connection service version of the CPU Unit to which to transfer the files is older than the database connection service version of the backup files on the SD Memory Card.	Replace the CPU Unit with a CPU Unit that has the same or a newer database connection service version than the database connection service version of the CPU Unit that was used to create the backup files. Or, specify backup files with the correct database connection service version for the CPU Unit.	Make sure that the database connection service version of the CPU Unit and the database connection service version of the backup files are compatible.
The robot version of the CPU Unit to which to transfer the files is older than the robot version of the backup files on the SD Memory Card.	Replace the CPU Unit with a CPU Unit that has the same or a newer robot version than the robot version of the CPU Unit that was used to create the backup files. Or, specify backup files with the correct robot version for the CPU Unit.	Make sure that the robot version of the CPU Unit and the robot version of the backup files are compatible.

Attached information	<p>Attached information 1: Operation type</p> <ul style="list-style-type: none"> • 0102 hex: SD Memory Card to Controller for specification with a system-defined variable <p>Attached Information 2: Error Details</p> <ul style="list-style-type: none"> • 0001 hex: An SD Memory Card is not inserted. • 0002 hex: The SD Memory Card is faulty, the format of the SD Memory Card is not correct, or the SD Memory Card is not the correct type of card. • 0004 hex: Recovery was executed for the SD Memory Card. • 0101 hex: There is no such folder on the SD Memory Card as specified by the <code>_Card1RestoreCmd.DirName</code> system-defined variable. • 0102 hex: There are no backup files in such a folder on the SD Memory Card as specified by the <code>_Card1RestoreCmd.DirName</code> system-defined variable. • 0103 hex: The backup files are corrupted. • 0104 hex: Required files are not set to transfer in the setting of the system-defined variable. • 0105 hex: The required transfer data is not in the backup file. • 0201 hex: The unit version of the CPU Unit is old. • 0202 hex: The model numbers of the CPU Unit are not the same. • 0203 hex: The CPU Unit is write-protected. • 0209 hex: The CPU Unit failed to process the power OFF during the last power interruption. • 0211 hex: The database connection service or robot version of the CPU Unit is old. • 0214 hex: The DIP switch on the CPU Unit is not set to allow starting the restore of SD Memory Card backups by specification with system-defined variables. • 0301 hex: Reading data for transferring the programs failed or the SD Memory Card is faulty. • 7F01 hex: An unexpected error has occurred.
Precautions/Remarks	None

*1. This event code occurs for unit version 1.14 or later of the CPU Unit.

Event name	Online Edits Transfer Failure		Event code	103F0000 hex		
Description	Transferring the online edits failed.					
Source	PLC Function Module	Source details	None	Detection timing	When online edits are transferred	
Error attributes	Level	Observation	Recovery	---	Log category	System
Effects	User program	Continues.	Operation	Not affected.		
System-defined variables	Variable	Data type		Name		
	None	---		---		
Cause and correction	Assumed cause	Correction		Prevention		
	The number of variables exceeded the upper limit of variables.	Check the memory usage condition and design a program again so that the number of definitions for retained variables and non-retained variables does not exceed the upper limit of variables.		When you create a program, check the memory usage condition and design the program so that the number of definitions for retained variables and non-retained variables does not exceed the upper limit of variables.		
	The variable setting for Initial Value Specified/No Initial Value Specified was changed.	Transfer the online edits without changing the variable setting for Initial Value Specified/No Initial Value Specified.		Use synchronization function to change the variable setting for Initial Value Specified/No Initial Value Specified.		
Attached information	<p>Attached information 1: Causes of failure</p> <ul style="list-style-type: none"> • 0001 hex: The number of variables exceeded the upper limit of variables. • 0002 hex: The variable setting for Initial Value Specified/No Initial Value Specified was changed. 					
Precautions/Remarks						

Event name	Variable Log Save Failed		Event code	152C0000Hex *1	
Meaning	Variable logs were not saved.				
Source	PLC Function Module		Source details	None	Detection timing When the variable log save conditions are met
Error attributes	Level	Observation	Recovery	Error reset after removing the cause of the error	Log category System
Effects	User program	Continues.	Operation	Not affected.	
System-defined variables	Variable	Data type		Name	
	_APB_LogStatus	ARRAY[1..2][1..2] OF _sAPB_LOG_STATUS		APB Log Output Status	
Cause and correction	Assumed cause		Correction		Prevention
	Although the conditions for saving the variable log were satisfied, the variable log could not be generated due to the following factors. <ul style="list-style-type: none"> The storage to save the log is unavailable for some reason. The storage to save the log is write-protected. Number of files or directories in the storage has reached the maximum number. 		Make the storage of the variable log available.		Output the variable log after confirming that the storage is available.
Attached information	Attached information 1: Storage type 1: SD Memory Card Attached information 2: Cause of the error <ul style="list-style-type: none"> 1400 hex: The storage to save the log is unavailable for some reason. 1401 hex: The storage to save the log is write-protected. 1402 hex: Number of files or directories in the storage has reached the maximum number. Attached information 3: Name of variable log output settings				
Precautions/Remarks	When the error is reset, an attempt to save the variable log is made again.				

*1. This event code occurs for an NX502 CPU Unit with unit version 1.63 or later.

Event name	Safety Data Logging Failed to Start		Event code	10630000 hex *1		
Description	Starting the safety data logging failed.					
Source	PLC Function Module	Source details	None	Detection timing	When safety data logging is started	
Error attributes	Level	Observation	Recovery	---	Log category	System
Effects	User program	Continues.	Operation	Not affected.		
System-defined variables	Variable	Data type		Name		
	None	---		---		
Cause and correction	Assumed cause	Correction		Prevention		
	An SD Memory Card is not inserted.	Insert an SD Memory Card.		Confirm that an SD Memory Card is inserted before you start logging.		
	There are no logging setting files.	Place logging setting files in the specified location "/SFLog/" of the SD Memory Card.		Place logging setting files in the specified location "/SFLog/".		
	The logging settings number of the logging setting file is duplicated.	Delete the unnecessary logging setting file.		Do not set the same logging settings number for more than one logging setting file.		
	The logging settings number of the logging setting file is outside of the specifications.	Create the logging setting file again in the project that was downloaded to the environment where the logging is executed.		Make sure to always transfer the logging settings after you change the project on the Sysmac Studio. Do not edit the logging setting file generated by the Sysmac Studio by any other means.		
	The logging setting files are invalid.	Create logging setting files again in the project transferred to the logging execution environment.		If you make changes to a project in the Sysmac Studio, transfer the logging settings again. Do not edit the logging setting files generated by the Sysmac Studio by other methods.		
	Not all of safety master connections are established.	Establish all safety master connections before attempting to start safety data logging.		Establish all safety master connections before attempting to start safety data logging.		
	Impossible to access a logging target variable that is specified in the logging setting file.	Create the logging setting file again in the project that was downloaded to the environment where the logging is executed.		Make sure to always transfer the logging settings after you change the project on the Sysmac Studio. Do not edit the logging setting file generated by the Sysmac Studio by any other means.		
Attached information	Attached information 1: Causes of failure <ul style="list-style-type: none"> • 0001 hex: An SD Memory Card is not inserted. • 0002 hex: There are no logging setting files. • 0003 hex: The logging settings number is duplicated. • 0004 hex: The logging settings number is outside of the specifications. • 0005 hex: The logging setting file is invalid. • 0006 hex: Safety master connections are not established. • 0007 hex: Impossible to access a logging target variable. 					
Precautions/Remarks	You cannot start safety data logging before safety validation is performed on the Safety CPU Unit.					

*1. This event code occurs for an NX502 CPU Unit with unit version 1.60 or later and NX102 CPU Unit with unit version 1.31 or later.

Event name	Safety Data Log File Save Failed		Event code	10640000 hex *1		
Description	Saving the log file for safety data logging failed.					
Source	PLC Function Module		Source details	None	Detection timing	When safety data logging file is saved
Error attributes	Level	Observation	Recovery	---	Log category	System
Effects	User program	Continues.	Operation	Not affected.		
System-defined variables	Variable	Data type		Name		
	None	---		---		
Cause and correction	Assumed cause		Correction		Prevention	
	The SD Memory Card was removed after the start of logging.		Insert an SD Memory Card.		Do not remove the SD Memory Card during logging execution.	
	The SD Memory Card is write-protected.		Remove write protection from the SD Memory Card.		Remove write protection from the SD Memory Card before you start logging.	
	The capacity of the SD Memory Card is insufficient.		Replace the SD Memory Card with one with sufficient available space.		Use an SD Memory Card that has sufficient available space.	
	The maximum number of files for an SD Memory Card was exceeded.		Delete files stored on the SD Memory Card to reduce the number of files.		Delete files periodically to reduce the number of files.	
	The SD Memory Card is damaged.		If none of the above causes applies, replace the SD Memory Card.		Replace the SD Memory Card periodically according to the write life of the SD Memory Card.	
Attached information	<p>Attached information 1: Causes of failure</p> <ul style="list-style-type: none"> • 0001 hex: An SD Memory Card is not inserted. • 0002 hex: The SD Memory Card is write-protected. • 0003 hex: The capacity of the SD Memory Card is insufficient. • 0004 hex: The maximum number of files was exceeded. • 0005 hex: Other causes <p>Attached information 2: The name of the log file that failed to be saved</p>					
Precautions/Remarks	None					

*1. This event code occurs for an NX502 CPU Unit with unit version 1.60 or later and NX102 CPU Unit with unit version 1.31 or later.

Event name	PLC System Information			Event code	40140000 hex	
Meaning	This event provides internal information from the PLC Function Module.					
Source	PLC Function Module		Source details	None	Detection timing	Continuously
Error attributes	Level	Observation	Recovery	---	Log category	System
Effects	User program	Continues.	Operation	Not affected.		
System-defined variables	Variable	Data type		Name		
	None	---		---		
Cause and correction	Assumed cause		Correction		Prevention	
	This event provides internal information from the PLC Function Module. It is recorded to provide additional information for another event.		---		---	
Attached information	Attached information 1: System information Attached information 2: System information Attached information 3: System information Attached information 4: System information					
Precautions/Remarks	None					

Event name	Safe Mode			Event code	40170000 hex *1	
Meaning	The Controller started in Safe Mode.					
Source	PLC Function Module		Source details	None	Detection timing	At power ON or Controller reset
Error attributes	Level	Observation	Recovery	---	Log category	System
Effects	User program	Stops.	Operation	---		
System-defined variables	Variable	Data type		Name		
	None	---		---		
Cause and correction	Assumed cause		Correction		Prevention	
	The Controller started in Safe Mode.		---		---	
Attached information	None					
Precautions/Remarks	If the Controller is started when the CPU Unit is in Safe Mode, the CPU Unit will start in PROGRAM mode even if the startup mode is set to RUN mode.					

*1. This event code occurs for unit version 1.03 or later of the CPU Unit.

Event name	Upper Limit of Sampling Processing Capacity		Event code	64040000 hex ^{*1}	
Meaning	Variable sampling was omitted because the sampling processing capacity exceeded the upper limit.				
Source	PLC Function Module		Source details	None	Detection timing During variable sampling
Error attributes	Level	Observation	Recovery	Transfer the project from Synchronization of Sysmac Studio after changing automation playback settings.	Log category System
Effects	User program	Continues.	Operation	Not affected.	
System-defined variables	Variable		Data type		Name
	_APB_Status		_sAPB_STATUS		APB Service Status
Cause and correction	Assumed cause		Correction		Prevention
	The sampling processing capacity exceeded the upper limit.		Configure the project so that variable sampling is finished within the task period by the following measures. <ul style="list-style-type: none"> • Reduce program POU's set for collection target. • Set a longer task period time. • Exclude axis variables from sampling (for primary periodic task only). 		Perform collection only for program POU's containing variables that need to be recorded in the variable log.
Attached information	Attached information 1: Task type with a cycle in which sampling is omitted <ul style="list-style-type: none"> • 0: Primary periodic task • 1: Periodic task 				
Precautions/Remarks	<ul style="list-style-type: none"> • Variable sampling continues. • When this event occurs, sampling of variables can be stopped and variable logging can be disabled by setting. • Once this event occurs, it will not recur until sampling of the variable has stops. 				

*1. This event code occurs for an NX502 CPU Unit with unit version 1.68 or later.

Event name	Capacity Warning of Variable Log Save Destination		Event code	64050000Hex ^{*1}	
Meaning	The free storage space for variable logs is less than the specified capacity.				
Source	PLC Function Module		Source details	None	Detection timing During variable sampling
Error attributes	Level	Observation	Recovery	Error reset	Log category System
Effects	User program	Continues.	Operation	Not affected.	
System-defined variables	Variable		Data type		Name
	None		---		---
Cause and correction	Assumed cause		Correction		Prevention
	The free storage space for variable logs has fallen below the specified capacity.		None		None
Attached information	Attached information 1: Storage type 1: SD Memory Card Attached information 2: Set value (MB)				
Precautions/Remarks	<ul style="list-style-type: none"> • This event notifies that free space of the storage is running out. It does not control variable log output. • Remaining free memory space is checked when the variable log is output. 				

*1. This event code occurs for an NX502 CPU Unit with unit version 1.63 or later.

Event name	No Variable Log Concurrency		Event code	64060000Hex *1		
Meaning	The task of the next task period started before variable sampling was completed. If the variable log is output in this status, the concurrency of the variable log data cannot be ensured.					
Source	PLC Function Module		Source details	None	Detection timing	During variable sampling
Error attributes	Level	Observation	Recovery	Transfer the project from Synchronization of Sysmac Studio after changing automation playback settings.	Log category	System
Effects	User program	Continues.	Operation	Not affected.		
System-defined variables	Variable		Data type		Name	
	_APB_Status		_sAPB_STATUS		APB Service Status	
Cause and correction	Assumed cause		Correction		Prevention	
	<p>Due to the following factors, the task of the next task period started before variable sampling was completed.</p> <ul style="list-style-type: none"> The number of variables to be sampled is too large. Task execution time as a ratio of overall task period is too high. 		<p>Configure the project so that variable sampling is finished within the task period by the following measures.</p> <ul style="list-style-type: none"> Reduce program POU's set for collection target. Set a longer task period time. Exclude axis variables from sampling (for primary periodic task only). 		<p>Perform collection only for program POU's containing variables that need to be recorded in the variable log.</p>	
Attached information	<p>Attached information 1: Task type for which sampling could not be finished within the task period</p> <ul style="list-style-type: none"> 0: Primary periodic task 1: Periodic task <p>Attached information 2: Number of sampling target variables for the task</p> <p>Attached information 3: Maximum time (μs) required from the start to the end of sampling for the task</p> <p>Attached information 4: Sampling setting number that needs modification</p>					
Precautions/Remarks	<ul style="list-style-type: none"> Variable sampling continues. You can stop sampling of variables by settings so as not to output variable logs for which concurrency is not ensured. Once this event occurs, it will not recur until sampling of the variable stops. 					

*1. This event code occurs for an NX502 CPU Unit with unit version 1.63 or later.

Event name	Cycle with No Variable Sampling		Event code	64070000Hex *1		
Meaning	A cycle occurred in which variable sampling was omitted.					
Source	PLC Function Module		Source details	None	Detection timing	During variable sampling
Error attributes	Level	Observation	Recovery	Transfer the project from Synchronization of Sysmac Studio after changing automation playback settings.	Log category	System
Effects	User program	Continues.	Operation	Not affected.		
System-defined variables	Variable		Data type		Name	
	_APB_Status		_sAPB_STATUS		APB Service Status	
Cause and correction	Assumed cause		Correction		Prevention	
	<p>Due to the following factors, a period in which variable sampling is not performed occurred.</p> <ul style="list-style-type: none"> The number of variables to be sampled is too large. Unused time in task period is too short. 		<p>Configure the project so that variable sampling is finished within the task period by the following measures.</p> <ul style="list-style-type: none"> Reduce program POU's set for collection target. Set a longer task period time. Exclude axis variables from sampling (for primary periodic task only). 		<p>Perform collection only for program POU's containing variables that need to be recorded in the variable log.</p>	
Attached information	<p>Attached information 1: Task type with a cycle in which sampling is omitted</p> <ul style="list-style-type: none"> 0: Primary periodic task 1: Periodic task <p>Attached information 2: Number of sampling target variables for the task</p> <p>Attached information 3: Maximum time (μs) required from the start to the end of sampling for the task</p> <p>Attached information 4: Sampling setting number that needs modification</p>					
Precautions/Remarks	<ul style="list-style-type: none"> Variable sampling continues. When this event occurs, sampling of variables can be stopped and variable logging can be disabled by setting. Once this event occurs, it will not recur until sampling of the variable has stops. 					

*1. This event code occurs for an NX502 CPU Unit with unit version 1.63 or later.

Event name	Secure Communication Forced Start		Event code	64080000Hex *1	
Meaning	Secure communication was forced to start.				
Source	PLC Function Module		Source details	None	Detection timing At power ON, or Controller reset
Error attributes	Level	Observation	Recovery	---	Log category System
Effects	User program	Continues.	Operation	Not affected.	
System-defined variables	Variable	Data type		Name	
	None	---		---	
Cause and correction	Assumed cause		Correction		Prevention
	The CPU Unit has started with the secure communications version set to 2 and the DIP switch <i>set to allow connection from the Sysmac Studio or an NA-series Programmable Terminal that does not support secure communication.</i>		When you use secure communications version 2, turn OFF pins 1 and 2 on the DIP switch of the CPU Unit, and then start the CPU Unit. When you use <i>set to allow connection from the Sysmac Studio or an NA-series Programmable Terminal that does not support secure communication</i> , change the secure communications version to 1 with administrator privileges.		---
Attached information	None				
Precautions/Remarks	None				

*1. This event code occurs for an NJ-series, NX502, NX102, or NX1P2 CPU Unit with unit version 1.69 or later and NX701 CPU Unit with unit version 1.36 or later.

Event name	NX Message Communications Error		Event code	80230000 hex ^{*1}		
Meaning	An error has occurred in message communications.					
Source	PLC Function Module, EtherCAT Master Function Module, EtherNet/IP Function Module, or NX Bus Function Module		Source details	None	Detection timing	During NX message communications
Error attributes	Level	Observation	Recovery	---	Log category	System
Effects	User program	Continues.	Operation	---		
System-defined variables	Variable	Data type		Name		
	None	---		---		
Cause and correction	Assumed cause		Correction		Prevention	
	The communications cable is broken.		Check the communications cable and replace it if it is broken.		Check the communications cable to see if it is operating properly.	
	The communications cable connector is disconnected.		Reconnect the connector and make sure it is mated correctly.		Make sure the communications cable is connected properly.	
	The NX message communications load is high.		Reduce the number of times that instructions are used to send NX messages. Or, increase the value of the <i>TimeOut</i> input variable to the instruction. If more than one copy of the Sysmac Studio is connected, reduce the frequency of simultaneous operations.		Reduce the number of times that instructions are used to send NX messages. Or, increase the value of the <i>TimeOut</i> input variable to the instruction. If more than one copy of the Sysmac Studio is connected, reduce the frequency of simultaneous operations.	
Attached information	Attached information 1: System information Attached information 2: Type of communications <ul style="list-style-type: none"> • 0: NX bus • 1: EtherCAT • 65,535: Unit internal communications (routing) 					
Precautions/Remarks	None					

*1. This event code occurs for unit version 1.05 or later of the CPU Unit.

Event name	Safety Data Logging Aborted		Event code	90470000 hex *1		
Description	The execution of safety data logging was aborted.					
Source	PLC Function Module		Source details	None	Detection timing	During the execution of safety data logging
Error attributes	Level	Observation	Recovery	---	Log category	System
Effects	User program	Continues.	Operation	Not affected.		
System-defined variables	Variable	Data type		Name		
	_PLC_SFLogSta	ARRAY[0..1] OF _sSFLOG_STA		Safety Data Logging Status		
Cause and correction	Assumed cause		Correction		Prevention	
	The execution of safety data logging was aborted by a service switch operation.		---		---	
	Either a communications error on the safety master connections occurred or the Safety CPU Unit entered an operating mode where it could not continue safety process data communications.		Check the safety process data communications related event that occurred most recently, and perform the required actions and corrections. Alternatively, change the Safety CPU Unit operating mode so that it can perform safety process data communications.		Make sure that safety process data communications are not interrupted unintentionally when you start safety data logging.	
	The NX bus was restarted.		---		---	
The Controller Setup or program was changed.		---		---		
Attached information	Attached information 1: Setting number for the aborted logging Attached information 2: The output log file name Attached information 3: Cause for the interruption <ul style="list-style-type: none"> • 1: A service switch was pressed. • 2: Safety master connections are not established. • 3: The NX bus was restarted. • 4: The Controller Setup or program was changed. 					
Precautions/Remarks	<ul style="list-style-type: none"> • The aborted safety data logging does not restart automatically even if the causes of aborting are removed. • The saved log data only includes data that was logged before the occurrence of aborting, regardless of the post-trigger ratio setting. 					

*1. This event code occurs for an NX502 CPU Unit with unit version 1.60 or later and NX102 CPU Unit with unit version 1.31 or later.

Event name	Variable Log Overwritten		Event code	95760000Hex *1		
Meaning	Old variable logs were cleared and new variable logs were saved.					
Source	PLC Function Module		Source details	None	Detection timing	When the variable log save conditions are met
Error attributes	Level	Observation	Recovery	Error reset	Log category	System
Effects	User program	Continues.	Operation	Not affected.		
System-defined variables	Variable	Data type		Name		
	None	---		---		
Cause and correction	Assumed cause		Correction		Prevention	
	There is not enough free space in the storage, or it has fallen below the specified capacity.		None		None	
Attached information	Attached information 1: Storage type 1: SD Memory Card Attached information 2: Set value (MB)					
Precautions/Remarks	When this event occurs, the old variable log has been deleted.					

*1. This event code occurs for an NX502 CPU Unit with unit version 1.63 or later.

Event name	Variable Log Save Not Possible		Event code	957A0000 hex *1		
Meaning	The variable log save conditions were met when the variable log could not be recorded.					
Source	PLC Function Module		Source details	None	Detection timing	When the variable log save conditions are met
Error attributes	Level	Observation	Recovery	---	Log category	System
Effects	User program	Continues.	Operation	Not affected.		
System-defined variables	Variable	Data type		Name		
	_APB_LogStatus	ARRAY[1..2][1..2] OF _sAPB_LOG_STATUS		APB Log Output Status		
Cause and correction	Assumed cause		Correction		Prevention	
	The variable log save conditions were met when the variable log could not be recorded.		Make sure that the save conditions are met when the <u>_APB_LogStatus.Status</u> (Variable Log Output Setting Status) system-defined variable has the following status. <ul style="list-style-type: none"> • Pre/Post trigger method: Sampling • Start/Save trigger method: Triggered 		Make sure that the save conditions are met when the <u>_APB_LogStatus.Status</u> (Variable Log Output Setting Status) system-defined variable has the following status. <ul style="list-style-type: none"> • Pre/Post trigger method: Sampling • Start/Save trigger method: Triggered 	
Attached information	Attached information 1: Variable Log Output Setting Status when the variable log storage conditions are met <ul style="list-style-type: none"> • 2: Sampling • 3: Triggered • 5: Storing • 6: Error 					
Precautions/Remarks	None					

*1. This event code occurs for an NX502 CPU Unit with unit version 1.68 or later.

Event name	PLC System Information			Event code	40150000 hex
Meaning	This event provides internal information from the PLC Function Module.				
Source	PLC Function Module		Source details	None	Detection timing Continuously
Error attributes	Level	Information	Recovery	---	Log category System
Effects	User program	Continues.	Operation	Not affected.	
System-defined variables	Variable		Data type		Name
	None		---		---
Cause and correction	Assumed cause		Correction		Prevention
	This event provides internal information from the PLC Function Module. It is recorded to provide additional information for another event.		---		---
Attached information	Attached information 1: System information Attached information 2: System information Attached information 3: System information Attached information 4: System information				
Precautions/Remarks	None				

Event name	PLC System Information			Event code	44430000 hex* ¹
Meaning	This event provides internal information from the PLC Function Module.				
Source	PLC Function Module		Source details	None	Detection timing Continuously
Error attributes	Level	Information	Recovery	---	Log category System
Effects	User program	Continues.	Operation	Not affected.	
System-defined variables	Variable		Data type		Name
	None		---		---
Cause and correction	Assumed cause		Correction		Prevention
	This event provides internal information from the PLC Function Module. It is recorded to provide additional information for another event.		---		---
Attached information	Attached information 1: System information Attached information 2: System information Attached information 3: System information Attached information 4: System information				
Precautions/Remarks	None				

*1. This event code occurs for unit version 1.05 or later of the CPU Unit.

Event name	Clock Changed			Event code	90010000 hex
Meaning	The clock time was changed.				
Source	PLC Function Module		Source details	None	Detection timing Commands from user
Error attributes	Level	Information	Recovery	---	Log category Access
Effects	User program	Continues.	Operation	Not affected.	
System-defined variables	Variable	Data type		Name	
	_CurrentTime	DATE_AND_TIME		System Time	
Cause and correction	Assumed cause		Correction		Prevention
	The clock time was changed.		---		---
Attached information	<p>Attached Information 1: Connection method</p> <ul style="list-style-type: none"> • 1: Direct Connection via USB • 2: Direct Ethernet connection • 3: Remote USB connection or Ethernet hub connection <p>Attached information 2: When attached information 1 is 2 or 3, the connection source IP address is given. When connection is made through proxy, proxy IP address is given.</p> <p>Attached information 3: Clock time before change</p>				
Precautions/Remarks	<p>A change of clock time caused by the NTP function or the Set Time instruction (SetTime) of NTP is not recorded in the event log.</p> <p>The time stamp for this event will be for the time after the change.</p>				
User name in the access log^{*1}	<p>When the user authentication function is enabled: User name</p> <p>When the user authentication function is disabled: NULL</p>				

*1. This information is registered in the following CPU Units.

- NJ-series, NX102, NX1P2 CPU Unit: Version 1.49 or later
- NX502 CPU Unit: Version 1.60 or later
- NX701 CPU Unit: Version 1.29 or later

Event name	Time Zone Changed			Event code	90020000 hex
Meaning	The time zone was changed.				
Source	PLC Function Module		Source details	None	Detection timing When downloading
Error attributes	Level	Information	Recovery	---	Log category Access
Effects	User program	Continues.	Operation	Not affected.	
System-defined variables	Variable	Data type		Name	
	_CurrentTime	DATE_AND_TIME		System Time	
Cause and correction	Assumed cause		Correction		Prevention
	The time zone was changed.		---		---
Attached information	<p>Attached Information 1: Connection method</p> <ul style="list-style-type: none"> • 1: Direct Connection via USB • 2: Direct Ethernet connection • 3: Remote USB connection or Ethernet hub connection <p>Attached information 2: When attached information 1 is 2 or 3, the connection source IP address is given. When connection is made through proxy, proxy IP address is given.</p>				
Precautions/Remarks	None				
User name in the access log^{*1}	<p>When the user authentication function is enabled: User name</p> <p>When the user authentication function is disabled: NULL</p>				

*1. This information is registered in the following CPU Units.

- NJ-series, NX102, NX1P2 CPU Unit: Version 1.49 or later
- NX502 CPU Unit: Version 1.60 or later
- NX701 CPU Unit: Version 1.29 or later

Event name	Online Connection Started		Event code	90030000 hex*1		
Meaning	Online connection with the Sysmac Studio was started.					
Source	PLC Function Module	Source details	None	Detection timing	When online connection starts	
Error attributes	Level	Information	Recovery	---	Log category	Access
Effects	User program	Continues.	Operation	Not affected.		
System-defined variables	Variable	Data type		Name		
	None	---		---		
Cause and correction	Assumed cause		Correction		Prevention	
	Online Connection with the Sysmac Studio was started.		---		---	
Attached information	Attached Information 1: Connection method <ul style="list-style-type: none"> • 1: Direct Connection via USB • 2: Direct Ethernet connection • 3: Remote USB connection or Ethernet hub connection Attached information 2: When attached information 1 is 2 or 3, the connection source IP address is given. When connection is made through proxy, proxy IP address is given.					
Precautions/Remarks	This event is recorded only when the Sysmac Studio version 1.50 or higher is used.					
User name in the access log	When the user authentication function is enabled: User name When the user authentication function is disabled: NULL					

*1. This event occurs when the following CPU Units are used in combination with Sysmac Studio Ver.1.50 or higher.

- NJ-series, NX102, NX1P2 CPU Unit: Version 1.49 or later
- NX502 CPU Unit: Version 1.60 or later
- NX701 CPU Unit: Version 1.29 or later

Event name	Online Connection Ended		Event code	90040000 hex ^{*1}		
Meaning	Online connection with the Sysmac Studio was terminated.					
Source	PLC Function Module	Source details	None	Detection timing	When online connection terminated	
Error attributes	Level	Information	Recovery	---	Log category	Access
Effects	User program	Continues.	Operation	Not affected.		
System-defined variables	Variable	Data type		Name		
	None	---		---		
Cause and correction	Assumed cause		Correction		Prevention	
	Online connection with the Sysmac Studio was terminated.		---		---	
Attached information	Attached Information 1: Connection method <ul style="list-style-type: none"> • 1: Direct Connection via USB • 2: Direct Ethernet connection • 3: Remote USB connection or Ethernet hub connection Attached information 2: When attached information 1 is 2 or 3, the connection source IP address is given. When connection is made through proxy, proxy IP address is given.					
Precautions/Remarks	This event is recorded only when the Sysmac Studio version 1.50 or higher is used.					
User name in the access log	When the user authentication function is enabled: User name When the user authentication function is disabled: NULL					

*1. This event occurs when the following CPU Units are used in combination with Sysmac Studio Ver.1.50 or higher.

- NJ-series, NX102, NX1P2 CPU Unit: Version 1.49 or later
- NX502 CPU Unit: Version 1.60 or later
- NX701 CPU Unit: Version 1.29 or later

Event name	User Program/Controller Configurations and Setup Downloaded		Event code	90050000 hex*1		
Meaning	The user program and the Controller configurations and setup were downloaded.					
Source	PLC Function Module	Source details	None	Detection timing	During user program/Controller configurations and setup download	
Error attributes	Level	Information	Recovery	---	Log category	Access
Effects	User program	Continues.	Operation	Operation starts according to the user program and the Controller setup data that were downloaded.		
System-defined variables	Variable	Data type		Name		
	None	---		---		
Cause and correction	Assumed cause		Correction		Prevention	
	The user program and the Controller configurations and setup were downloaded.		---		---	
Attached information	<p>Attached Information 1: Connection method</p> <ul style="list-style-type: none"> • 1: Direct USB connection • 2: Direct Ethernet connection • 3: Remote USB connection or Ethernet hub connection <p>Attached information 2: When attached information 1 is 2 or 3, the connection source IP address is given. When connection is made through proxy, proxy IP address is given.</p> <p>Attached information 3: Device Output Hold Status</p> <ul style="list-style-type: none"> • 1: Retained. • 2: Not retained. 					
Precautions/Remarks	None					
User name in the access log*2	<p>When the user authentication function is enabled: User name</p> <p>When the user authentication function is disabled: NULL</p>					

*1. This event code occurs for unit version 1.10 or later of the CPU Unit.

*2. This information is registered in the following CPU Units.

- NJ-series, NX102, NX1P2 CPU Unit: Version 1.49 or later
- NX502 CPU Unit: Version 1.60 or later
- NX701 CPU Unit: Version 1.29 or later

Event name	Online Edits Transferred		Event code	90070000 hex ^{*1}	
Meaning	The user program was edited online.				
Source	PLC Function Module		Source details	None	Detection timing When transferring online edits is started
Error attributes	Level	Information	Recovery	---	Log category Access
Effects	User program	Continues.	Operation	Operation is performed according to the changed user program.	
System-defined variables	Variable	Data type		Name	
	None	---		---	
Cause and correction	Assumed cause		Correction		Prevention
	The user program was edited online and the edits were transferred to the Controller.		---		---
Attached information	Attached Information 1: Connection method • 1: Direct USB connection • 2: Direct Ethernet connection • 3: Remote USB connection or Ethernet hub connection Attached information 2: When attached information 1 is 2 or 3, the connection source IP address is given. When connection is made through proxy, proxy IP address is given.				
Precautions/Remarks	None				
User name in the access log^{*2}	When the user authentication function is enabled: User name When the user authentication function is disabled: NULL				

*1. This event code occurs for unit version 1.10 or later of the CPU Unit.

*2. This information is registered in the following CPU Units.

- NJ-series, NX102, NX1P2 CPU Unit: Version 1.49 or later
- NX502 CPU Unit: Version 1.60 or later
- NX701 CPU Unit: Version 1.29 or later

Event name	Variable Changed to TRUE with Forced Refreshing		Event code	90080000 hex	
Meaning	Changing a variable to TRUE with forced refreshing was specified.				
Source	PLC Function Module		Source details	None	Detection timing Commands from user
Error attributes	Level	Information	Recovery	---	Log category Access
Effects	User program	Continues.	Operation	Operation is performed according to the forced refreshing values.	
System-defined variables	Variable	Data type		Name	
	None	---		---	
Cause and correction	Assumed cause		Correction		Prevention
	Changing a variable to TRUE with forced refreshing was specified by the user.		---		---
Attached information	None				
Precautions/Remarks	None				

Event name	Variable Changed to FALSE with Forced Refreshing			Event code	90090000 hex	
Meaning	Changing a variable to FALSE with forced refreshing was specified.					
Source	PLC Function Module		Source details	None	Detection timing	Commands from user
Error attributes	Level	Information	Recovery	---	Log category	Access
Effects	User program	Continues.	Operation	Operation is performed according to the forced refreshing values.		
System-defined variables	Variable	Data type		Name		
	None	---		---		
Cause and correction	Assumed cause		Correction		Prevention	
	Changing a variable to FALSE with forced refreshing was specified by the user.		---		---	
Attached information	None					
Precautions/Remarks	None					

Event name	All Forced Refreshing Cleared			Event code	900A0000 hex	
Meaning	Clearing all forced refreshing values was specified.					
Source	PLC Function Module		Source details	None	Detection timing	Commands from user
Error attributes	Level	Information	Recovery	---	Log category	Access
Effects	User program	Continues.	Operation	Forced refreshing values are all cleared and operation is performed according to the user program.		
System-defined variables	Variable	Data type		Name		
	None	---		---		
Cause and correction	Assumed cause		Correction		Prevention	
	Clearing all forced refreshing values was specified by the user.		---		---	
Attached information	None					
Precautions/Remarks	None					

Event name	Memory All Cleared		Event code	900B0000 hex	
Meaning	All of memory was cleared.				
Source	PLC Function Module		Source details	None	Detection timing Commands from user
Error attributes	Level	Information	Recovery	---	Log category Access
Effects	User program	---	Operation	Operation returns to the factory state.	
System-defined variables	Variable	Data type		Name	
	None	---		---	
Cause and correction	Assumed cause		Correction		Prevention
	A user with Administrator rights cleared all of the memory.		---		---
Attached information	Attached Information 1: Connection method • 1: Direct Connection via USB • 2: Direct Ethernet connection • 3: Remote USB connection or Ethernet hub connection Attached information 2: When attached information 1 is 2 or 3, the connection source IP address is given. When connection is made through proxy, proxy IP address is given.				
Precautions/Remarks	None				
User name in the access log^{*1}	When the user authentication function is enabled: User name When the user authentication function is disabled: NULL				

- *1. This information is registered in the following CPU Units.
- NJ-series, NX102, NX1P2 CPU Unit: Version 1.49 or later
 - NX502 CPU Unit: Version 1.60 or later
 - NX701 CPU Unit: Version 1.29 or later

Event name	Event Log Cleared			Event code	900C0000 hex	
Meaning	The event log was cleared.					
Source	PLC Function Module		Source details	None	Detection timing	Commands from user
Error attributes	Level	Information	Recovery	---	Log category	Access
Effects	User program	Continues.	Operation	Not affected.		
System-defined variables	Variable	Data type		Name		
	None	---		---		
Cause and correction	Assumed cause		Correction		Prevention	
	The event log was cleared by the user.		---		---	
Attached information	<p>Attached Information 1: Connection method</p> <ul style="list-style-type: none"> • 1: Direct Connection via USB • 2: Direct Ethernet connection • 3: Remote USB connection or Ethernet hub connection <p>Attached information 2: When attached information 1 is 2 or 3, the connection source IP address is given. When connection is made through proxy, proxy IP address is given.</p> <p>Attached information 3: Cleared events</p> <ul style="list-style-type: none"> • 0: Logs for all categories were cleared. • 1: The system event log was cleared. • 2: The access event log was cleared. • 100: The user-defined event log was cleared. 					
Precautions/Remarks	None					
User name in the access log^{*1}	<p>When the user authentication function is enabled: User name</p> <p>When the user authentication function is disabled: NULL</p>					

*1. This information is registered in the following CPU Units.

- NJ-series, NX102, NX1P2 CPU Unit: Version 1.49 or later
- NX502 CPU Unit: Version 1.60 or later
- NX701 CPU Unit: Version 1.29 or later

Event name	Automatic Transfer Completed			Event code	900F0000 hex ^{*1}	
Meaning	The automatic transfer was completed.					
Source	PLC Function Module		Source details	None	Detection timing	At power ON
Error attributes	Level	Information	Recovery	---	Log category	System
Effects	User program	Continues.	Operation	Operation starts according to the Controller Configurations and Setup data that was automatically transferred.		
System-defined variables	Variable	Data type		Name		
	None	---		---		
Cause and correction	Assumed cause		Correction		Prevention	
	The automatic transfer was completed.		---		---	
Attached information	None					
Precautions/Remarks	None					

*1. This event code occurs for unit version 1.03 or later of the CPU Unit.

Event name	Power Turned ON			Event code	90110000 hex	
Meaning	The power supply was turned ON.					
Source	PLC Function Module		Source details	None	Detection timing	At power ON
Error attributes	Level	Information	Recovery	---	Log category	System
Effects	User program	---	Operation	Operation starts.		
System-defined variables	Variable		Data type		Name	
	None		---		---	
Cause and correction	Assumed cause		Correction		Prevention	
	The power supply was turned ON.		---		---	
Attached information	None					
Precautions/Remarks	None					

Event name	Power Interrupted			Event code	90120000 hex	
Meaning	The power supply was interrupted.					
Source	PLC Function Module		Source details	None	Detection timing	At power interruption
Error attributes	Level	Information	Recovery	---	Log category	System
Effects	User program	Stops.	Operation	All operations stop.		
System-defined variables	Variable		Data type		Name	
	None		---		---	
Cause and correction	Assumed cause		Correction		Prevention	
	The power supply was interrupted.		---		---	
Attached information	None					
Precautions/Remarks	None					

Event name	Operation Started			Event code	90130000 hex	
Meaning	Operation was started.					
Source	PLC Function Module		Source details	None	Detection timing	When changing to RUN mode
Error attributes	Level	Information	Recovery	---	Log category	System
Effects	User program	Starts.	Operation	User program execution starts.		
System-defined variables	Variable		Data type		Name	
	None		---		---	
Cause and correction	Assumed cause		Correction		Prevention	
	A command to start operation was received.		---		---	
Attached information	Attached information 1: Device Output Hold Status <ul style="list-style-type: none"> • 1: Retained. • 2: Not retained. 					
Precautions/Remarks	None					

Event name	Operation Stopped			Event code	90140000 hex	
Meaning	Operation was stopped.					
Source	PLC Function Module	Source details	None	Detection timing	When changing to PROGRAM mode	
Error attributes	Level	Information	Recovery	---	Log category	System
Effects	User program	Stops.	Operation	User program execution stops.		
System-defined variables	Variable	Data type		Name		
	None	---		---		
Cause and correction	Assumed cause	Correction		Prevention		
	A command to stop operation was received.	---		---		
Attached information	Attached information 1: Device Output Hold Status <ul style="list-style-type: none"> • 1: Retained. • 2: Not retained. 					
Precautions/Remarks	None					

Event name	Reset Executed			Event code	90150000 hex	
Meaning	A reset was executed.					
Source	PLC Function Module	Source details	None	Detection timing	Commands from user	
Error attributes	Level	Information	Recovery	---	Log category	Access
Effects	User program	---	Operation	Operation is started after a reset is executed.		
System-defined variables	Variable	Data type		Name		
	None	---		---		
Cause and correction	Assumed cause	Correction		Prevention		
	A reset command was received.	---		---		
Attached information	Attached Information 1: Connection method <ul style="list-style-type: none"> • 1: Direct Connection via USB • 2: Direct Ethernet connection • 3: Remote USB connection or Ethernet hub connection Attached information 2: When attached information 1 is 2 or 3, the connection source IP address is given. When connection is made through proxy, proxy IP address is given.					
Precautions/Remarks	None					
User name in the access log^{*1}	When the user authentication function is enabled: User name When the user authentication function is disabled: NULL					

*1. This information is registered in the following CPU Units.

- NJ-series, NX102, NX1P2 CPU Unit: Version 1.49 or later
- NX502 CPU Unit: Version 1.60 or later
- NX701 CPU Unit: Version 1.29 or later

Event name	User Program Execution ID Write		Event code	90160000 hex	
Meaning	The user program execution ID was set or changed in the CPU Unit.				
Source	PLC Function Module		Source details	None	Detection timing When downloading
Error attributes	Level	Information	Recovery	---	Log category Access
Effects	User program	Continues.	Operation	Not affected.	
System-defined variables	Variable	Data type		Name	
	None	---		---	
Cause and correction	Assumed cause	Correction		Prevention	
	A user with Administrator rights changed the user program execution ID that is set in the CPU Unit.	---		---	
Attached information	None				
Precautions/Remarks	Attached Information 1: Connection method • 1: Direct Connection via USB • 2: Direct Ethernet connection • 3: Remote USB connection or Ethernet hub connection Attached information 2: When attached information 1 is 2 or 3, the connection source IP address is given. When connection is made through proxy, proxy IP address is given.				
User name in the access log^{*1}	When the user authentication function is enabled: User name When the user authentication function is disabled: NULL				

*1. This information is registered in the following CPU Units.

- NJ-series, NX102, NX1P2 CPU Unit: Version 1.49 or later
- NX502 CPU Unit: Version 1.60 or later
- NX701 CPU Unit: Version 1.29 or later

Event name	Authentication Setting Transferred			Event code	90170000 hex*1	
Meaning	The authentication setting was transferred.					
Source	PLC Function Module	Source details	None	Detection timing	When user account settings are changed	
Error attributes	Level	Information	Recovery	---	Log category	Access
Effects	User program	Continues.	Operation	Not affected.		
System-defined variables	Variable	Data type		Name		
	None	---		---		
Cause and correction	Assumed cause		Correction		Prevention	
	The authentication setting was transferred.		---		---	
Attached information	Attached Information 1: Connection method <ul style="list-style-type: none"> • 1: Direct Connection via USB • 2: Direct Ethernet connection • 3: Remote USB connection or Ethernet hub connection Attached information 2: When attached information 1 is 2 or 3, the connection source IP address is given. When connection is made through proxy, proxy IP address is given.					
Precautions/Remarks	This event is recorded only when the Sysmac Studio version 1.50 or higher is used.					
User name in the access log	When the user authentication function is enabled: User name When the user authentication function is disabled: NULL					

*1. This event occurs when the following CPU Units are used in combination with Sysmac Studio Ver.1.50 or higher.

- NJ-series, NX102, NX1P2 CPU Unit: Version 1.49 or later
- NX502 CPU Unit: Version 1.60 or later
- NX701 CPU Unit: Version 1.29 or later

Event name	All Controller Errors Cleared			Event code	90180000 hex	
Meaning	All current errors were cleared.					
Source	PLC Function Module	Source details	None	Detection timing	Commands from user	
Error attributes	Level	Information	Recovery	---	Log category	Access
Effects	User program	Continues.	Operation	Clearing all errors for which the causes have been removed.		
System-defined variables	Variable	Data type		Name		
	None	---		---		
Cause and correction	Assumed cause		Correction		Prevention	
	The user cleared all current errors.		---		---	
Attached information	None					
Precautions/Remarks	None					

Event name	Forced Refreshing Cleared			Event code	90190000 hex
Meaning	Clearing a forced refreshing value was specified.				
Source	PLC Function Module		Source details	None	Detection timing Commands from user
Error attributes	Level	Information	Recovery	---	Log category Access
Effects	User program	Continues.	Operation	Forced refreshing values are cleared and operation is performed according to the user program.	
System-defined variables	Variable	Data type		Name	
	None	---		---	
Cause and correction	Assumed cause		Correction		Prevention
	Clearing a forced refreshing value was specified by the user.		---		---
Attached information	None				
Precautions/Remarks	None				

Event name	Backup Started			Event code	901A0000 hex ^{*1}
Meaning	A backup operation was started.				
Source	PLC Function Module		Source details	None	Detection timing At start of back-up operation
Error attributes	Level	Information	Recovery	---	Log category System
Effects	User program	Continues.	Operation	Not affected.	
System-defined variables	Variable	Data type		Name	
	None	---		---	
Cause and correction	Assumed cause		Correction		Prevention
	A backup operation was started.		---		---
Attached information	Attached information 1: Operation type <ul style="list-style-type: none"> • 0101 hex: Controller to SD Memory Card for switch operation on front of CPU Unit • 0102 hex: Controller to SD Memory Card for system-defined variable operation • 0103 hex: Controller to SD Memory Card for instruction from Sysmac Studio or function module specific trigger) • 0104 hex: Controller to SD Memory Card for instruction operation • 0201 hex: Controller to computer 				
Precautions/Remarks	None				

*1. This event code occurs for unit version 1.03 or later of the CPU Unit.

Event name	Backup Completed			Event code	901B0000 hex*1	
Meaning	The backup operation ended normally.					
Source	PLC Function Module		Source details	None	Detection timing	At end of normal backup operation
Error attributes	Level	Information	Recovery	---	Log category	System
Effects	User program	Continues.	Operation	Not affected.		
System-defined variables	Variable	Data type		Name		
	None	---		---		
Cause and correction	Assumed cause		Correction		Prevention	
	The backup operation ended normally.		---		---	
Attached information	Attached information 1: Operation type <ul style="list-style-type: none"> • 0101 hex: Controller to SD Memory Card for switch operation on front of CPU Unit • 0102 hex: Controller to SD Memory Card for system variable operation • 0103 hex: Controller to SD Memory Card for instruction from Sysmac Studio or function module specific trigger) • 0104 hex: Controller to SD Memory Card for instruction operation. • 0201 hex: Controller to computer 					
Precautions/Remarks	None					

*1. This event code occurs for unit version 1.03 or later of the CPU Unit.

Event name	Restore Operation Started			Event code	901C0000 hex*1	
Meaning	A restore operation started.					
Source	PLC Function Module		Source details	None	Detection timing	At start of restore operation
Error attributes	Level	Information	Recovery	---	Log category	System
Effects	User program	---	Operation	Not affected.		
System-defined variables	Variable	Data type		Name		
	None	---		---		
Cause and correction	Assumed cause		Correction		Prevention	
	A restore operation started.		---		---	
Attached information	Attached information 1: Operation type <ul style="list-style-type: none"> • 0101 hex: SD Memory Card to Controller for switch operation on front of CPU Unit • 0102 hex: SD Memory Card to Controller for specification with a system-defined variable • 0201 hex: Computer to Controller 					
Precautions/Remarks	None					

*1. This event code occurs for unit version 1.03 or later of the CPU Unit.

Event name	Restore Operation Completed		Event code	901D0000 hex*1		
Meaning	The restore operation ended normally.					
Source	PLC Function Module		Source details	None	Detection timing	At end of normal restore operation
Error attributes	Level	Information	Recovery	---	Log category	System
Effects	User program	---	Operation	Operation does not start after the completion of a restore operation. To start operation according to the restored user program and settings, turn OFF the power supply to the Controller, turn OFF all pins on the DIP switch on the CPU Unit, and then turn ON the power supply again.		
System-defined variables	Variable	Data type		Name		
	_Card1RestoreSta	_sRESTORE_STA		SD Memory Card Restore Status		
Cause and correction	Assumed cause		Correction		Prevention	
	The restore operation ended normally.		---		---	
Attached information	Attached information 1: Operation type <ul style="list-style-type: none"> • 0101 hex: SD Memory Card to Controller for switch operation on front of CPU Unit • 0102 hex: SD Memory Card to Controller for specification with a system-defined variable • 0201 hex: Computer to Controller 					
Precautions/Remarks	None					

*1. This event code occurs for unit version 1.03 or later of the CPU Unit.

Event name	SD Memory Card Program Transfer Started		Event code	90200000 hex*1		
Meaning	Transferring the SD Memory Card programs was started.					
Source	PLC Function Module		Source details	None	Detection timing	When transferring SD Memory Card programs is started
Error attributes	Level	Information	Recovery	---	Log category	System
Effects	User program	---	Operation	Not affected.		
System-defined variables	Variable	Data type		Name		
	None	---		---		
Cause and correction	Assumed cause		Correction		Prevention	
	Transferring the SD Memory Card programs was started.		---		---	
Attached information	None					
Precautions/Remarks	None					

*1. This event code occurs for unit version 1.11 or later of the CPU Unit.

Event name	SD Memory Card Program Transfer Completed		Event code	90210000 hex*1		
Meaning	Transferring the SD Memory Card programs was completed.					
Source	PLC Function Module		Source details	None	Detection timing	When transferring SD Memory Card programs is completed
Error attributes	Level	Information	Recovery	---	Log category	System
Effects	User program	---	Operation	Not affected.		
System-defined variables	Variable	Data type		Name		
	_Card1PrgTransferSta	_sPRGTRANSFER_STA		SD Memory Card Program Transfer Status		
Cause and correction	Assumed cause		Correction		Prevention	
	Transferring the SD Memory Card programs was completed.		---		---	
Attached information	None					
Precautions/Remarks	None					

*1. This event code occurs for unit version 1.11 or later of the CPU Unit.

Event name	Project Unit Version Changed		Event code	90290000 hex*1		
Meaning	The project unit version was changed.					
Source	PLC Function Module		Source details	None	Detection timing	At download, restore, or Clear All Memory operation
Error attributes	Level	Information	Recovery	---	Log category	Access
Effects	User program	---	Operation	Not affected.		
System-defined variables	Variable	Data type		Name		
	_ProjectUnitVersion *2	ARRAY[0..1] OF USINT		Project Unit Version		
Cause and correction	Assumed cause		Correction		Prevention	
	The project unit version of the project in the Controller in the transfer or restore destination and that in the transfer or restore source project are different.		---		---	
	The project was transferred or restored in the default or Clear All Memory state.		---		---	
Attached information	Attached information 1: Project unit version before change The major and minor versions are displayed. In the default or Clear All Memory state, however, 0 is displayed. Example: In the default state, 0 is displayed. Attached information 2: Project unit version after change The major and minor versions are displayed. In the Clear All Memory state, however, 0 is displayed. Example: If the unit version is 1.21, 121 is displayed.					
Precautions/Remarks	None					

*1. This event code occurs for an NX102-□□□□ CPU Unit with unit version 1.32 or later and NX701-□□□□ CPU Unit, NX1P2-□□□□ CPU Unit, NJ501-□□□□ CPU Unit (excluding NJ501-□□20), NJ301-□□□□ CPU Unit, and NJ101-□□□□ CPU Unit with unit version 1.21 or later.

*2. You can use this system-defined variable for the CPU Unit with unit version 1.40 or later.

Event name	Change to RUN Mode Commanded		Event code	902A0000 hex*1	
Meaning	The Controller received a command to switch to RUN mode.				
Source	PLC Function Module		Source details	None	Detection timing Commands from user
Error attributes	Level	Information	Recovery	---	Log category Access
Effects	User program	Continues.	Operation	Not affected.	
System-defined variables	Variable	Data type		Name	
	None	---		---	
Cause and correction	Assumed cause		Correction		Prevention
	The Controller received a command to switch to RUN mode.		---		---
Attached information	Attached information 1: Connection method <ul style="list-style-type: none"> • 1: Direct connection via USB • 2: Direct connection via Ethernet • 3: Remote Connection via USB or Ethernet connection via a hub Attached information 2: When attached information 1 is 2 or 3, the connection source IP address is given. When connection is made through proxy, proxy IP address is given.				
Precautions/Remarks	None				
User name in the access log	When the user authentication function is enabled: User name When the user authentication function is disabled: NULL				

*1. This event code occurs for the following CPU Units.

- NJ-series, NX102, NX1P2 CPU Unit: Version 1.49 or later
- NX502 CPU Unit: Version 1.60 or later
- NX701 CPU Unit: Version 1.29 or later

Event name	Change to PROGRAM Mode Commanded		Event code	902B0000 hex*1	
Meaning	The Controller received a command to switch to PROGRAM mode.				
Source	PLC Function Module		Source details	None	Detection timing Commands from user
Error attributes	Level	Information	Recovery	---	Log category Access
Effects	User program	Continues.	Operation	Not affected.	
System-defined variables	Variable	Data type		Name	
	None	---		---	
Cause and correction	Assumed cause		Correction		Prevention
	The Controller received a command to switch to PROGRAM mode.		---		---
Attached information	Attached information 1: Connection method <ul style="list-style-type: none"> • 1: Direct connection via USB • 2: Direct connection via Ethernet • 3: Remote Connection via USB or Ethernet connection via a hub Attached information 2: When attached information 1 is 2 or 3, the connection source IP address is given. When connection is made through proxy, proxy IP address is given.				
Precautions/Remarks	None				
User name in the access log	When the user authentication function is enabled: User name When the user authentication function is disabled: NULL				

*1. This event code occurs for the following CPU Units.

- NJ-series, NX102, NX1P2 CPU Unit: Version 1.49 or later
- NX502 CPU Unit: Version 1.60 or later
- NX701 CPU Unit: Version 1.29 or later

Event name	Access Rights Forcibly Released			Event code	902C0000 hex*1	
Meaning	The access rights were forcibly released.					
Source	PLC Function Module		Source details	None	Detection timing	Commands from user
Error attributes	Level	Information	Recovery	---	Log category	Access
Effects	User program	Continues.	Operation	Not affected.		
System-defined variables	Variable	Data type		Name		
	None	---		---		
Cause and correction	Assumed cause		Correction		Prevention	
	The access rights were forcibly released.		---		---	
Attached information	Attached Information 1: Connection method <ul style="list-style-type: none"> • 1: Direct Connection via USB • 2: Direct Ethernet connection • 3: Remote USB connection or Ethernet hub connection Attached information 2: When attached information 1 is 2 or 3, the connection source IP address is given. When connection is made through proxy, proxy IP address is given.					
Precautions/Remarks	None					
User name in the access log	When the user authentication function is enabled: User name When the user authentication function is disabled: NULL					

*1. This event code occurs for the following CPU Units.

- NJ-series, NX102, NX1P2 CPU Unit: Version 1.49 or later
- NX502 CPU Unit: Version 1.60 or later
- NX701 CPU Unit: Version 1.29 or later

Event name	CPU Unit Name Changed			Event code	902D0000 hex*1	
Meaning	The CPU Unit name was changed.					
Source	PLC Function Module		Source details	None	Detection timing	Commands from user
Error attributes	Level	Information	Recovery	---	Log category	Access
Effects	User program	Continues.	Operation	Not affected.		
System-defined variables	Variable	Data type		Name		
	None	---		---		
Cause and correction	Assumed cause		Correction		Prevention	
	The CPU Unit name was changed.		---		---	
Attached information	Attached Information 1: Connection method <ul style="list-style-type: none"> • 1: Direct Connection via USB • 2: Direct Ethernet connection • 3: Remote USB connection or Ethernet hub connection Attached information 2: When attached information 1 is 2 or 3, the connection source IP address is given. When connection is made through proxy, proxy IP address is given.					
Precautions/Remarks	None					
User name in the access log	When the user authentication function is enabled: User name When the user authentication function is disabled: NULL					

*1. This event code occurs for the following CPU Units.

- NJ-series, NX102, NX1P2 CPU Unit: Version 1.49 or later
- NX502 CPU Unit: Version 1.60 or later
- NX701 CPU Unit: Version 1.29 or later

Event name	CPU Unit Write Protected		Event code	902E0000 hex ^{*1}	
Meaning	The CPU Unit was write-protected.				
Source	PLC Function Module		Source details	None	Detection timing Commands from user
Error attributes	Level	Information	Recovery	---	Log category Access
Effects	User program	Continues.	Operation	Not affected.	
System-defined variables	Variable	Data type		Name	
	None	---		---	
Cause and correction	Assumed cause		Correction		Prevention
	The CPU Unit was write-protected.		---		---
Attached information	Attached Information 1: Connection method • 1: Direct Connection via USB • 2: Direct Ethernet connection • 3: Remote USB connection or Ethernet hub connection Attached information 2: When attached information 1 is 2 or 3, the connection source IP address is given. When connection is made through proxy, proxy IP address is given.				
Precautions/Remarks	None				
User name in the access log	When the user authentication function is enabled: User name When the user authentication function is disabled: NULL				

*1. This event code occurs for the following CPU Units.

- NJ-series, NX102, NX1P2 CPU Unit: Version 1.49 or later
- NX502 CPU Unit: Version 1.60 or later
- NX701 CPU Unit: Version 1.29 or later

Event name	Operation Mode Change Setting Written		Event code	902F0000 hex ^{*1}	
Meaning	Setting to change the operation mode was written.				
Source	PLC Function Module		Source details	None	Detection timing Commands from user
Error attributes	Level	Information	Recovery	---	Log category Access
Effects	User program	Continues.	Operation	Not affected.	
System-defined variables	Variable	Data type		Name	
	None	---		---	
Cause and correction	Assumed cause		Correction		Prevention
	Setting to change the operation mode was written.		---		---
Attached information	Attached Information 1: Connection method • 1: Direct Connection via USB • 2: Direct Ethernet connection • 3: Remote USB connection or Ethernet hub connection Attached information 2: When attached information 1 is 2 or 3, the connection source IP address is given. When connection is made through proxy, proxy IP address is given.				
Precautions/Remarks	This event is recorded only when the Sysmac Studio version 1.50 or higher is used.				
User name in the access log	When the user authentication function is enabled: User name When the user authentication function is disabled: NULL				

*1. This event occurs when the following CPU Units are used in combination with Sysmac Studio Ver.1.50 or higher.

- NJ-series, NX102, NX1P2 CPU Unit: Version 1.49 or later
- NX502 CPU Unit: Version 1.60 or later
- NX701 CPU Unit: Version 1.29 or later

Event name	Backup Start Commanded			Event code	90300000 hex*1	
Meaning	The Controller received a command to start backup operation from Sysmac Studio.					
Source	PLC Function Module		Source details	None	Detection timing	Commands from user
Error attributes	Level	Information	Recovery	---	Log category	Access
Effects	User program	Continues.	Operation	Not affected.		
System-defined variables	Variable	Data type		Name		
	None	---		---		
Cause and correction	Assumed cause		Correction		Prevention	
	The Controller received a command to start backup operation from Sysmac Studio.		---		---	
Attached information	Attached Information 1: Connection method <ul style="list-style-type: none"> • 1: Direct Connection via USB • 2: Direct Ethernet connection • 3: Remote USB connection or Ethernet hub connection Attached information 2: When attached information 1 is 2 or 3, the connection source IP address is given. When connection is made through proxy, proxy IP address is given.					
Precautions/Remarks	None					
User name in the access log	When the user authentication function is enabled: User name When the user authentication function is disabled: NULL					

*1. This event code occurs for the following CPU Units.

- NJ-series, NX102, NX1P2 CPU Unit: Version 1.49 or later
- NX502 CPU Unit: Version 1.60 or later
- NX701 CPU Unit: Version 1.29 or later

Event name	Restore Start Commanded			Event code	90310000 hex*1	
Meaning	The Controller received a command to start restore operation from Sysmac Studio.					
Source	PLC Function Module		Source details	None	Detection timing	Commands from user
Error attributes	Level	Information	Recovery	---	Log category	Access
Effects	User program	Continues.	Operation	Not affected.		
System-defined variables	Variable	Data type		Name		
	None	---		---		
Cause and correction	Assumed cause		Correction		Prevention	
	The Controller received a command to start restore operation from Sysmac Studio.		---		---	
Attached information	Attached Information 1: Connection method <ul style="list-style-type: none"> • 1: Direct Connection via USB • 2: Direct Ethernet connection • 3: Remote USB connection or Ethernet hub connection Attached information 2: When attached information 1 is 2 or 3, the connection source IP address is given. When connection is made through proxy, proxy IP address is given.					
Precautions/Remarks	None					
User name in the access log	When the user authentication function is enabled: User name When the user authentication function is disabled: NULL					

*1. This event code occurs for the following CPU Units.

- NJ-series, NX102, NX1P2 CPU Unit: Version 1.49 or later
- NX502 CPU Unit: Version 1.60 or later
- NX701 CPU Unit: Version 1.29 or later

Event name	Firmware Update Prohibition Setting Changed		Event code	90320000 hex ^{*1}		
Meaning	Firmware update prohibition setting was changed.					
Source	PLC Function Module		Source details	None	Detection timing	At download
Error attributes	Level	Information	Recovery	---	Log category	System
Effects	User program	Continues.	Operation	Not affected.		
System-defined variables	Variable	Data type		Name		
	None	---		---		
Cause and correction	Assumed cause	Correction		Prevention		
	Firmware update prohibition setting was changed.	---		---		
Attached information	Attached information 1: Setting <ul style="list-style-type: none"> • 1: Prohibit execution of firmware update • 2: Allow execution of firmware update 					
Precautions/Remarks	None					

*1. This event code occurs for the following CPU Units.

- NJ-series, NX102, NX1P2 CPU Unit: Version 1.60 or later
- NX701 CPU Unit: Version 1.32 or later

Event name	Start Instruction of Omron Maintenance		Event code	90330000 hex ^{*1}		
Meaning	Maintenance by Omron maintenance personnel was begun.					
Source	PLC Function Module		Source details	None	Detection timing	When instructed by Omron maintenance personnel
Error attributes	Level	Information	Recovery	---	Log category	Access
Effects	User program	Continues.	Operation	Not affected.		
System-defined variables	Variable	Data type		Name		
	None	---		---		
Cause and correction	Assumed cause	Correction		Prevention		
	Maintenance by Omron maintenance personnel was begun.	---		---		
Attached information	Attached information 1: Name of the maintenance personnel					
Precautions/Remarks	None					

*1. This event code occurs for the following CPU Units.

- NJ-series, NX102, NX1P2 CPU Unit: Version 1.49 or later
- NX502 CPU Unit: Version 1.60 or later
- NX701 CPU Unit: Version 1.29 or later

Event name	End Instruction of Omron Maintenance		Event code	90340000 hex*1		
Meaning	Maintenance by Omron maintenance personnel was ended.					
Source	PLC Function Module		Source details	None	Detection timing	When instructed by Omron maintenance personnel
Error attributes	Level	Information	Recovery	---	Log category	Access
Effects	User program	Continues.	Operation	Not affected.		
System-defined variables	Variable		Data type		Name	
	None		---		---	
Cause and correction	Assumed cause		Correction		Prevention	
	Maintenance by Omron maintenance personnel was ended.		---		---	
Attached information	Attached information 1: Name of the maintenance personnel					
Precautions/Remarks	None					

*1. This event code occurs for the following CPU Units.

- NJ-series, NX102, NX1P2 CPU Unit: Version 1.49 or later
- NX502 CPU Unit: Version 1.60 or later
- NX701 CPU Unit: Version 1.29 or later

Event name	Safety Data Logging Started		Event code	90460000 hex *1		
Description	Safety data logging was started.					
Source	PLC Function Module		Source details	None	Detection timing	When safety data logging is started
Error attributes	Level	Information	Recovery	---	Log category	System
Effects	User program	Continues.	Operation	Not affected.		
System-defined variables	Variable		Data type		Name	
	_PLC_SFLogSta		ARRAY[0..1] OF _sSFLOG_STA		Safety Data Logging Status	
Cause and correction	Assumed cause		Correction		Prevention	
	Safety data logging was started because the start conditions were met.		---		---	
Attached information	Attached information 1: Setting number for the started logging					
Precautions/Remarks	None					

*1. This event code occurs for an NX502 CPU Unit with unit version 1.60 or later and NX102 CPU Unit with unit version 1.31 or later.

3 Error Descriptions and Corrections

Event name	Safety Data Logging Completed		Event code	90480000 hex *1		
Description	The execution of safety data logging was completed because the trigger conditions were met.					
Source	PLC Function Module	Source details	None	Detection timing	When safety data logging is completed	
Error attributes	Level	Information	Recovery	---	Log category	System
Effects	User program	Continues.	Operation	Not affected.		
System-defined variables	Variable	Data type		Name		
	_PLC_SFLogSta	ARRAY[0..1] OF _sSFLOG_STA		Safety Data Logging Status		
Cause and correction	Assumed cause	Correction		Prevention		
	The trigger condition that is specified in the Safety Data Logging Settings is met, and safety data logging ends.	---		---		
Attached information	Attached information 1: Setting number for the completed logging Attached information 2: The output log file name					
Precautions/Remarks	If more than one safety data logging is executed, do not remove or insert the SD Memory Card until all the safety data logging executions are completed and the data is saved to the SD Memory Card.					

*1. This event code occurs for an NX502 CPU Unit with unit version 1.60 or later and NX102 CPU Unit with unit version 1.31 or later.

Event name	User Authentication Enabled		Event code	90A20000 hex *1	
Meaning	User authentication was enabled.				
Source	PLC Function Module	Source details	None	Detection timing	When user account settings are changed
Error attributes	Level	Information	Log category	Access	
	Recovery	---			
Effects	User program	Continues.	Operation	Not affected.	
System-defined variables	Variable	Data type		Name	
	None	---		---	
Cause and correction	Assumed cause	Correction		Prevention	
	User authentication was enabled.	None		None	
Attached information	None				
Precautions/Remarks	This event is recorded only when the Sysmac Studio version 1.50 or higher is used.				
User name in the access log	User name				

*1. This event code occurs for the following CPU Units.

- NJ-series, NX102, NX1P2 CPU Unit: Version 1.49 or later
- NX502 CPU Unit: Version 1.60 or later
- NX701 CPU Unit: Version 1.29 or later

Event name	User Authentication Disabled		Event code	90A30000 hex*1	
Meaning	User authentication was disabled.				
Source	PLC Function Module	Source details	None	Detection timing	When user account settings are changed
Error attributes	Level	Information		Log category	Access
	Recovery	---			
Effects	User program	Continues.	Operation	Not affected.	
System-defined variables	Variable	Data type		Name	
	None	---		---	
Cause and correction	Assumed cause	Correction		Prevention	
	User authentication was disabled.	None		None	
Attached information	None				
Precautions/Remarks	This event is recorded only when the Sysmac Studio version 1.50 or higher is used.				
User name in the access log	User name				

*1. This event code occurs for the following CPU Units.

- NJ-series, NX102, NX1P2 CPU Unit: Version 1.49 or later
- NX502 CPU Unit: Version 1.60 or later
- NX701 CPU Unit: Version 1.29 or later

Event name	User Added		Event code	90A40000 hex*1	
Meaning	A user was added.				
Source	PLC Function Module	Source details	None	Detection timing	When user account settings are changed
Error attributes	Level	Information		Log category	Access
	Recovery	---			
Effects	User program	Continues.	Operation	Not affected.	
System-defined variables	Variable	Data type		Name	
	None	---		---	
Cause and correction	Assumed cause		Correction		Prevention
	A user was added.		None		None
Attached information	Attached information 1: Given authority <ul style="list-style-type: none"> • 0: Administrator • 1: Designer • 2: Maintainer • 3: Operator • 4: Observer Attached information 2: Name of the added user				
Precautions/Remarks	This event is recorded only when the Sysmac Studio version 1.50 or higher is used.				
User name in the access log	User name				

*1. This event code occurs for the following CPU Units.

- NJ-series, NX102, NX1P2 CPU Unit: Version 1.49 or later
- NX502 CPU Unit: Version 1.60 or later
- NX701 CPU Unit: Version 1.29 or later

Event name	User Deleted		Event code	90A50000 hex*1	
Meaning	A user was deleted.				
Source	PLC Function Module	Source details	None	Detection timing	When user account settings are changed
Error attributes	Level	Information		Log category	Access
	Recovery	---			
Effects	User program	Continues.	Operation	Not affected.	
System-defined variables	Variable	Data type		Name	
	None	---		---	
Cause and correction	Assumed cause		Correction		Prevention
	A user was deleted.		None		None
Attached information	Attached information 1: Name of the deleted user				
Precautions/Remarks	This event is recorded only when the Sysmac Studio version 1.50 or higher is used.				
User name in the access log	User name				

*1. This event code occurs for the following CPU Units.

- NJ-series, NX102, NX1P2 CPU Unit: Version 1.49 or later
- NX502 CPU Unit: Version 1.60 or later
- NX701 CPU Unit: Version 1.29 or later

Event name	User Authority Changed		Event code	90A60000 hex*1	
Meaning	A user authority was changed.				
Source	PLC Function Module	Source details	None	Detection timing	When user account settings are changed
Error attributes	Level	Information		Log category	Access
	Recovery	---			
Effects	User program	Continues.	Operation	Not affected.	
System-defined variables	Variable	Data type		Name	
	None	---		---	
Cause and correction	Assumed cause		Correction		Prevention
	A user authority was changed.		None		None
Attached information	Attached information 1: Given authority <ul style="list-style-type: none"> • 0: Administrator • 1: Designer • 2: Maintainer • 3: Operator • 4: Observer Attached information 2: Name of the user whose authority was changed				
Precautions/Remarks	This event is recorded only when the Sysmac Studio version 1.50 or higher is used.				
User name in the access log	User name				

- *1. This event code occurs for the following CPU Units.
- NJ-series, NX102, NX1P2 CPU Unit: Version 1.49 or later
 - NX502 CPU Unit: Version 1.60 or later
 - NX701 CPU Unit: Version 1.29 or later

Event name	User Password Changed		Event code	90A70000 hex*1	
Meaning	A user password was changed.				
Source	PLC Function Module	Source details	None	Detection timing	When user account settings are changed
Error attributes	Level	Information		Log category	Access
	Recovery	---			
Effects	User program	Continues.	Operation	Not affected.	
System-defined variables	Variable	Data type		Name	
	None	---		---	
Cause and correction	Assumed cause		Correction		Prevention
	A user password was changed.		None		None
Attached information	Attached information 1: Name of the user whose password was changed				
Precautions/Remarks	This event is recorded only when the Sysmac Studio version 1.50 or higher is used.				
User name in the access log	User name				

*1. This event code occurs for the following CPU Units.

- NJ-series, NX102, NX1P2 CPU Unit: Version 1.49 or later
- NX502 CPU Unit: Version 1.60 or later
- NX701 CPU Unit: Version 1.29 or later

Event name	User Password Validity Period Control Enabled		Event code	90A80000 hex*1	
Meaning	Control of user password validity period was activated.				
Source	PLC Function Module	Source details	None	Detection timing	When user account settings are changed
Error attributes	Level	Information		Log category	Access
	Recovery	---			
Effects	User program	Continues.	Operation	Not affected.	
System-defined variables	Variable	Data type		Name	
	None	---		---	
Cause and correction	Assumed cause		Correction		Prevention
	Control of user password validity period was activated.		None		None
Attached information	None				
Precautions/Remarks	This event is recorded only when the Sysmac Studio version 1.50 or higher is used.				
User name in the access log	User name				

*1. This event code occurs for the following CPU Units.

- NJ-series, NX102, NX1P2 CPU Unit: Version 1.49 or later
- NX502 CPU Unit: Version 1.60 or later
- NX701 CPU Unit: Version 1.29 or later

Event name	User Password Validity Period Control Disabled		Event code	90A90000 hex*1	
Meaning	Control of user password validity period was disabled.				
Source	PLC Function Module	Source details	None	Detection timing	When user account settings are changed
Error attributes	Level	Information		Log category	Access
	Recovery	---			
Effects	User program	Continues.	Operation	Not affected.	
System-defined variables	Variable	Data type		Name	
	None	---		---	
Cause and correction	Assumed cause	Correction		Prevention	
	Control of user password validity period was disabled.	None		None	
Attached information	None				
Precautions/Remarks	This event is recorded only when the Sysmac Studio version 1.50 or higher is used.				
User name in the access log	User name				

*1. This event code occurs for the following CPU Units.

- NJ-series, NX102, NX1P2 CPU Unit: Version 1.49 or later
- NX502 CPU Unit: Version 1.60 or later
- NX701 CPU Unit: Version 1.29 or later

Event name	User Password Validity Period Changed		Event code	90AA0000 hex*1	
Meaning	A validity period of user password was changed.				
Source	PLC Function Module	Source details	None	Detection timing	When user account settings are changed
Error attributes	Level	Information		Log category	Access
	Recovery	---			
Effects	User program	Continues.	Operation	Not affected.	
System-defined variables	Variable	Data type		Name	
	None	---		---	
Cause and correction	Assumed cause	Correction		Prevention	
	A validity period of user password was changed.	None		None	
Attached information	None				
Precautions/Remarks	This event is recorded only when the Sysmac Studio version 1.50 or higher is used.				
User name in the access log	User name				

*1. This event code occurs for the following CPU Units.

- NJ-series, NX102, NX1P2 CPU Unit: Version 1.49 or later
- NX502 CPU Unit: Version 1.60 or later
- NX701 CPU Unit: Version 1.29 or later

Event name	User Authentication Operation Lock Enabled		Event code	90AB0000 hex*1	
Meaning	Operation lock of user authentication function was enabled.				
Source	PLC Function Module	Source details	None	Detection timing	When user account settings are changed
Error attributes	Level	Information		Log category	Access
	Recovery	---			
Effects	User program	Continues.	Operation	Not affected.	
System-defined variables	Variable	Data type		Name	
	None	---		---	
Cause and correction	Assumed cause	Correction		Prevention	
	Operation lock of user authentication function was enabled.	None		None	
Attached information	None				
Precautions/Remarks	This event is recorded only when the Sysmac Studio version 1.50 or higher is used.				
User name in the access log	User name				

*1. This event code occurs for the following CPU Units.

- NJ-series, NX102, NX1P2 CPU Unit: Version 1.49 or later
- NX502 CPU Unit: Version 1.60 or later
- NX701 CPU Unit: Version 1.29 or later

Event name	User Authentication Operation Lock Disabled		Event code	90AC0000 hex*1	
Meaning	Operation lock of user authentication function was disabled.				
Source	PLC Function Module	Source details	None	Detection timing	When user account settings are changed
Error attributes	Level	Information		Log category	Access
	Recovery	---			
Effects	User program	Continues.	Operation	Not affected.	
System-defined variables	Variable	Data type		Name	
	None	---		---	
Cause and correction	Assumed cause	Correction		Prevention	
	Operation lock of user authentication function was disabled.	None		None	
Attached information	None				
Precautions/Remarks	This event is recorded only when the Sysmac Studio version 1.50 or higher is used.				
User name in the access log	User name				

*1. This event code occurs for the following CPU Units.

- NJ-series, NX102, NX1P2 CPU Unit: Version 1.49 or later
- NX502 CPU Unit: Version 1.60 or later
- NX701 CPU Unit: Version 1.29 or later

Event name	User Authentication Operation Lock Time Changed	Event code	90AD0000 hex ^{*1}		
Meaning	Operation lock time of user authentication function was changed.				
Source	PLC Function Module	Source details	None	Detection timing	When user account settings are changed
Error attributes	Level	Information		Log category	Access
	Recovery	---			
Effects	User program	Continues.	Operation	Not affected.	
System-defined variables	Variable	Data type		Name	
	None	---		---	
Cause and correction	Assumed cause	Correction		Prevention	
	Operation lock time of user authentication function was changed.	None		None	
Attached information	Attached information 1: Set time				
Precautions/Remarks	This event is recorded only when the Sysmac Studio version 1.50 or higher is used.				
User name in the access log	User name				

- *1. This event code occurs for the following CPU Units.
- NJ-series, NX102, NX1P2 CPU Unit: Version 1.49 or later
 - NX502 CPU Unit: Version 1.60 or later
 - NX701 CPU Unit: Version 1.29 or later

Event name	Operation Authority Verification Enabled		Event code	90AE0000 hex*1	
Meaning	Operation authority verification was enabled.				
Source	PLC Function Module	Source details	None	Detection timing	When changing operation authority verification setting
Error attributes	Level	Information	Log category	Access	
	Recovery	---			
Effects	User program	Continues.	Operation	Not affected.	
System-defined variables	Variable	Data type		Name	
	None	---		---	
Cause and correction	Assumed cause	Correction		Prevention	
	Operation authority verification was enabled.	None		None	
Attached information	None				
Precautions/Remarks	This event is recorded only when the Sysmac Studio version 1.50 or higher is used.				
User name in the access log	When the user authentication function is enabled: User name When the user authentication function is disabled: NULL				

*1. This event code occurs for the following CPU Units.

- NJ-series, NX102, NX1P2 CPU Unit: Version 1.49 or later
- NX502 CPU Unit: Version 1.60 or later
- NX701 CPU Unit: Version 1.29 or later

Event name	Operation Authority Verification Disabled		Event code	90AF0000 hex*1	
Meaning	Operation authority verification was disabled.				
Source	PLC Function Module	Source details	None	Detection timing	When changing operation authority verification setting
Error attributes	Level	Information	Log category	Access	
	Recovery	---			
Effects	User program	Continues.	Operation	Not affected.	
System-defined variables	Variable	Data type		Name	
	None	---		---	
Cause and correction	Assumed cause		Correction		Prevention
	Operation authority verification was disabled.		None		None
Attached information	None				
Precautions/Remarks	This event is recorded only when the Sysmac Studio version 1.50 or higher is used.				
User name in the access log	When the user authentication function is enabled: User name				
	When the user authentication function is disabled: NULL				

- *1. This event code occurs for the following CPU Units.
- NJ-series, NX102, NX1P2 CPU Unit: Version 1.49 or later
 - NX502 CPU Unit: Version 1.60 or later
 - NX701 CPU Unit: Version 1.29 or later

Event name	Operation Authority Password Changed		Event code	90B00000 hex*1	
Meaning	A operation authority password was changed.				
Source	PLC Function Module	Source details	None	Detection timing	When changing operation authority verification setting
Error attributes	Level	Information	Log category	Access	
	Recovery	---			
Effects	User program	Continues.	Operation	Not affected.	
System-defined variables	Variable		Data type	Name	
	None		---	---	
Cause and correction	Assumed cause		Correction	Prevention	
	A operation authority password was changed.		None	None	
Attached information	Attached information 1: authority whose password was changed <ul style="list-style-type: none"> • 0: Administrator • 1: Designer • 2: Maintainer • 3: Operator • 4: Observer 				
Precautions/Remarks	This event is recorded only when the Sysmac Studio version 1.50 or higher is used.				
User name in the access log	When the user authentication function is enabled: User name When the user authentication function is disabled: NULL				

*1. This event code occurs for the following CPU Units.

- NJ-series, NX102, NX1P2 CPU Unit: Version 1.49 or later
- NX502 CPU Unit: Version 1.60 or later
- NX701 CPU Unit: Version 1.29 or later

Event name	Operation Authority for Password Input Omission Changed		Event code	90B10000 hex*1	
Meaning	An operation authority used when password input is omitted was changed.				
Source	PLC Function Module	Source details	None	Detection timing	When changing operation authority verification setting
Error attributes	Level	Information		Log category	Access
	Recovery	---			
Effects	User program	Continues.	Operation	Not affected.	
System-defined variables	Variable	Data type		Name	
	None	---		---	
Cause and correction	Assumed cause		Correction		Prevention
	An operation authority used when password input is omitted was changed.		None		None
Attached information	Attached information 1: Given authority <ul style="list-style-type: none"> • 0: Administrator • 1: Designer • 2: Maintainer • 3: Operator • 4: Observer 				
Precautions/Remarks	This event is recorded only when the Sysmac Studio version 1.50 or higher is used.				
User name in the access log	When the user authentication function is enabled: User name When the user authentication function is disabled: NULL				

*1. This event code occurs for the following CPU Units.

- NJ-series, NX102, NX1P2 CPU Unit: Version 1.49 or later
- NX502 CPU Unit: Version 1.60 or later
- NX701 CPU Unit: Version 1.29 or later

Event name	Operation Authority Verification Operation Lock Enabled		Event code	90B20000 hex*1	
Meaning	Operation lock of operation authority verification function was enabled.				
Source	PLC Function Module	Source details	None	Detection timing	When changing operation authority verification setting
Error attributes	Level	Information		Log category	Access
	Recovery	---			
Effects	User program	Continues.	Operation	Not affected.	
System-defined variables	Variable	None		Data type	---
				Name	---
Cause and correction	Assumed cause	Operation lock of operation authority verification function was enabled.		Correction	None
				Prevention	None
Attached information	None				
Precautions/Remarks	This event is recorded only when the Sysmac Studio version 1.50 or higher is used.				
User name in the access log	When the user authentication function is enabled: User name When the user authentication function is disabled: NULL				

*1. This event code occurs for the following CPU Units.

- NJ-series, NX102, NX1P2 CPU Unit: Version 1.49 or later
- NX502 CPU Unit: Version 1.60 or later
- NX701 CPU Unit: Version 1.29 or later

Event name	Operation Authority Verification Operation Lock Disabled		Event code	90B30000 hex*1	
Meaning	Operation lock of operation authority verification function was disabled.				
Source	PLC Function Module	Source details	None	Detection timing	When changing operation authority verification setting
Error attributes	Level	Information		Log category	Access
	Recovery	---			
Effects	User program	Continues.	Operation	Not affected.	
System-defined variables	Variable	Data type		Name	
	None	---		---	
Cause and correction	Assumed cause	Correction		Prevention	
	Operation lock of operation authority verification function was disabled.	None		None	
Attached information	None				
Precautions/Remarks	This event is recorded only when the Sysmac Studio version 1.50 or higher is used.				
User name in the access log	When the user authentication function is enabled: User name				
	When the user authentication function is disabled: NULL				

*1. This event code occurs for the following CPU Units.

- NJ-series, NX102, NX1P2 CPU Unit: Version 1.49 or later
- NX502 CPU Unit: Version 1.60 or later
- NX701 CPU Unit: Version 1.29 or later

Event name	Operation Authority Verification Operation Lock Time Changed		Event code	90B40000 hex*1	
Meaning	Operation lock time of operation authority verification function was changed.				
Source	PLC Function Module	Source details	None	Detection timing	When changing operation authority verification setting
Error attributes	Level	Information		Log category	Access
	Recovery	---			
Effects	User program	Continues.	Operation	Not affected.	
System-defined variables	Variable	Data type		Name	
	None	---		---	
Cause and correction	Assumed cause	Correction		Prevention	
	Operation lock time of operation authority verification function was changed.	None		None	
Attached information	Attached information 1: Set time				
Precautions/Remarks	This event is recorded only when the Sysmac Studio version 1.50 or higher is used.				
User name in the access log	When the user authentication function is enabled: User name When the user authentication function is disabled: NULL				

*1. This event code occurs for the following CPU Units.

- NJ-series, NX102, NX1P2 CPU Unit: Version 1.49 or later
- NX502 CPU Unit: Version 1.60 or later
- NX701 CPU Unit: Version 1.29 or later

Event name	User Password Expiration Notice Enabled		Event code	90B50000 hex*1		
Meaning	User password expiration notice was enabled.					
Source	PLC Function Module	Source details	None	Detection timing	When User Authentication Settings were changed	
Error attributes	Level	Information	Recovery	---	Log category	Access
Effects	User program	Continues.	Operation	Not affected.		
System-defined variables	Variable	Data type		Name		
	None	---		---		
Cause and correction	Assumed cause	Correction		Prevention		
	User password expiration notice was enabled.	---		---		
Attached information	None					
Precautions/Remarks	This event is recorded only when the Sysmac Studio version 1.50 or higher is used.					
User name in the access log	User name					

*1. This event code occurs for the following CPU Units.

- NJ-series, NX102, NX1P2 CPU Unit: Version 1.49 or later
- NX502 CPU Unit: Version 1.60 or later
- NX701 CPU Unit: Version 1.29 or later

Event name	User Password Expiration Notice Disabled		Event code	90B60000 hex ^{*1}	
Meaning	User password expiration notice was disabled.				
Source	PLC Function Module		Source details	None	Detection timing When User Authentication Settings were changed
Error attributes	Level	Information	Recovery	---	Log category Access
Effects	User program	Continues.	Operation	Not affected.	
System-defined variables	Variable	Data type		Name	
	None	---		---	
Cause and correction	Assumed cause		Correction		Prevention
	User password expiration notice was disabled.		---		---
Attached information	None				
Precautions/Remarks	This event is recorded only when the Sysmac Studio version 1.50 or higher is used.				
User name in the access log	User name				

*1. This event code occurs for the following CPU Units.

- NJ-series, NX102, NX1P2 CPU Unit: Version 1.49 or later
- NX502 CPU Unit: Version 1.60 or later
- NX701 CPU Unit: Version 1.29 or later

Event name	Days for Prior Notice of User Password Expiration Changed		Event code	90B70000 hex ^{*1}	
Meaning	Number of days set to give prior notice of user password expiration was changed.				
Source	PLC Function Module		Source details	None	Detection timing When user account settings are changed
Error attributes	Level	Information	Recovery	---	Log category Access
Effects	User program	Continues.	Operation	Not affected.	
System-defined variables	Variable	Data type		Name	
	None	---		---	
Cause and correction	Assumed cause		Correction		Prevention
	Number of days set to give prior notice of user password expiration was changed.		---		---
Attached information	None				
Precautions/Remarks	This event is recorded only when the Sysmac Studio version 1.50 or higher is used.				
User name in the access log	User name				

*1. This event code occurs for the following CPU Units.

- NJ-series, NX102, NX1P2 CPU Unit: Version 1.49 or later
- NX502 CPU Unit: Version 1.60 or later
- NX701 CPU Unit: Version 1.29 or later

Event name	Secure Communications Version Changed		Event code	90B80000 hex*1		
Meaning	The secure communications version was changed.					
Source	PLC Function Module	Source details	None	Detection timing	When secure communications version is changed	
Error attributes	Level	Information	Recovery	---	Log category	Access
Effects	User program	Continues.	Operation	Not affected.		
System-defined variables	Variable	Data type		Name		
	None	---		---		
Cause and correction	Assumed cause		Correction		Prevention	
	The secure communications version was changed.		---		---	
Attached information	Attached information 1: Secure communications version before change Attached information 2: Secure communications version after change					
Precautions/Remarks	None					
User name in the access log	When the user authentication function is enabled: User name When the user authentication function is disabled: NULL					

*1. This event code occurs for an NJ-series, NX502, NX102, or NX1P2 CPU Unit with unit version 1.69 or later and NX701 CPU Unit with unit version 1.36 or later.

Event name	Automation Playback Settings Changed		Event code	95720000Hex *1		
Meaning	The settings for the automation playback function were changed.					
Source	PLC Function Module	Source details	None	Detection timing	When synchronized with Sysmac Studio	
Error attributes	Level	Information	Recovery	---	Log category	Access
Effects	User program	Continues.	Operation	Not affected.		
System-defined variables	Variable	Data type		Name		
	_APB_Status	_sAPB_STATUS		APB Service Status		
	_APB_LogStatus	ARRAY[1..2][1..2] OF _sAPB_LOG_STATUS		APB Log Output Status		
Cause and correction	Assumed cause		Correction		Prevention	
	The Controller is synchronized with a project with changed settings on Sysmac Studio.		None		None	
Attached information	None					
Precautions/Remarks	None					
User name in the access log	When the user authentication function is enabled: User name When the user authentication function is disabled: NULL					

*1. This event code occurs for an NX502 CPU Unit with unit version 1.63 or later.

Event name	Variable Sampling Started			Event code	95730000Hex *1
Meaning	Variable sampling started.				
Source	PLC Function Module		Source details	None	Detection timing When variable sampling starts
Error attributes	Level	Information	Recovery	---	Log category System
Effects	User program	Continues.	Operation	Not affected.	
System-defined variables	Variable	Data type		Name	
	_APB_Status	_sAPB_STATUS		APB Service Status	
	_APB_LogStatus	ARRAY[1..2][1..2] OF _sAPB_LOG_STATUS		APB Log Output Status	
Cause and correction	Assumed cause		Correction		Prevention
	Conditions to start variable sampling are met.		None		None
Attached information	None				
Precautions/Remarks	None				

*1. This event code occurs for an NX502 CPU Unit with unit version 1.63 or later.

Event name	Variable Sampling Stopped			Event code	95740000Hex *1
Meaning	Variable sampling stopped.				
Source	PLC Function Module		Source details	None	Detection timing When variable sampling stops
Error attributes	Level	Information	Recovery	---	Log category System
Effects	User program	Continues.	Operation	Not affected.	
System-defined variables	Variable	Data type		Name	
	_APB_Status	_sAPB_STATUS		APB Service Status	
Cause and correction	Assumed cause		Correction		Prevention
	Conditions to end variable sampling are met.		None		None
Attached information	None				
Precautions/Remarks	None				

*1. This event code occurs for an NX502 CPU Unit with unit version 1.63 or later.

Event name	Variable Log Output Completed			Event code	95750000Hex *1	
Meaning	Variable log output has completed.					
Source	PLC Function Module		Source details	None	Detection timing	When variable log output is complete
Error attributes	Level	Information	Recovery	---	Log category	System
Effects	User program	Continues.	Operation	Not affected.		
System-defined variables	Variable	Data type		Name		
	_APB_LogStatus	ARRAY[1..2][1..2] OF _sAPB_LOG_STATUS		APB Log Output Status		
Cause and correction	Assumed cause		Correction		Prevention	
	Save conditions of variable log are satisfied and output is completed.		None		None	
Attached information	Attached information 1: Storage type 1: SD Memory Card Attached information 2: Name of variable log output settings Attached information 3: Sampling time of variable logs (seconds) Attached information 4: Memory capacity for sampled variables (bytes)					
Precautions/Remarks	None					

*1. This event code occurs for an NX502 CPU Unit with unit version 1.63 or later earlier than version 1.65.

Event name	Variable Log Output Completed			Event code	95780000 hex *1	
Meaning	Variable log output has completed.					
Source	PLC Function Module		Source details	None	Detection timing	When variable log output is complete
Error attributes	Level	Information	Recovery	---	Log category	System
Effects	User program	Continues.	Operation	Not affected.		
System-defined variables	Variable	Data type		Name		
	_APB_LogStatus	ARRAY[1..2][1..2] OF _sAPB_LOG_STATUS		APB Log Output Status		
Cause and correction	Assumed cause		Correction		Prevention	
	Save conditions of variable log are satisfied and output is completed.		None		None	
Attached information	Attached information 1: Storage type 1: SD Memory Card Attached information 2: Name of variable log output settings Attached information 3: Sampling time of variable logs (seconds) Attached information 4: Memory capacity for sampled variables (KB)					
Precautions/Remarks	None					

*1. This event code occurs for an NX502 CPU Unit with unit version 1.65 or later.

Errors Related to FINS Communications

Event name	CPU Bus Unit Setup Area Error		Event code	14010000 hex		
Meaning	An error was detected in the memory check of the Setup Area for CPU Bus Units.					
Source	PLC Function Module		Source details	None	Detection timing	At power ON, at Controller reset, or when writing CPU Bus Unit Setup Area
Error attributes	Level	Minor fault	Recovery	Error reset or cycling power supply	Log category	System
Effects	User program	Continues.	Operation	The CPU Bus Unit may stop.		
System-defined variables	Variable	Data type		Name		
	None	---		---		
Cause and correction	Assumed cause	Correction		Prevention		
	The power supply to the Controller was interrupted or communications with the Sysmac Studio were disconnected while downloading the CPU Bus Unit Settings.	Clear all memory or download the CPU Bus Unit Settings. If this error persists, replace the CPU Unit.		Do not interrupt the power supply to the Controller or disconnect communications with the Sysmac Studio while downloading the CPU Bus Unit Settings.		
Attached information	None					
Precautions/Remarks	None					

Event name	IP Address Table Setting Error		Event code	34100000 hex		
Meaning	The IP address table settings are incorrect.					
Source	PLC Function Module		Source details	None	Detection timing	At power ON, Controller reset, or restart of built-in Ethernet port
Error attributes	Level	Minor fault	Recovery	Error reset	Log category	System
Effects	User program	Continues.	Operation	FINS/UDP communications will not operate.		
System-defined variables	Variable	Data type		Name		
	None	---		---		
Cause and correction	Assumed cause	Correction		Prevention		
	The IP address conversion method is set to the combined method or the IP address table method, but the IP address table settings are incorrect.	Correct the IP address table settings.		Set the IP address table correctly.		
Attached information	None					
Precautions/Remarks	None					

Event name	FINS/TCP Connection Table Setting Error		Event code	34130000 hex		
Meaning	The FINS/TCP connection table is incorrect.					
Source	PLC Function Module		Source details	None	Detection timing	At power ON, Controller reset, or restart of built-in Ethernet port
Error attributes	Level	Minor fault	Recovery	Error reset	Log category	System
Effects	User program	Continues.	Operation	FINS/TCP communications will not operate.		
System-defined variables	Variable	Data type		Name		
	None	---		---		
Cause and correction	Assumed cause		Correction		Prevention	
	The power supply to the Controller was interrupted or communications with the Sysmac Studio were disconnected while downloading the FINS/TCP connection table.		Download the FINS/TCP connection table again.		Do not interrupt the power supply to the Controller or disconnect communications with the Sysmac Studio while downloading the FINS/TCP connection table.	
Attached information	None					
Precautions/Remarks	None					

Event name	Unknown Destination Node		Event code	34110000 hex		
Meaning	The send destination node is not known.					
Source	PLC Function Module		Source details	None	Detection timing	At FINS message transmission
Error attributes	Level	Observation	Recovery	---	Log category	System
Effects	User program	Continues.	Operation	Not affected. Packets are discarded.		
System-defined variables	Variable	Data type		Name		
	None	---		---		
Cause and correction	Assumed cause		Correction		Prevention	
	The send destination node was not found when a FINS message was sent.		Correct the setting of the send destination node for FINS/UDP communications. Or, check the source FINS message and correct the destination node address.		Set the send destination node for FINS/UDP communications correctly. Or, make sure that the destination node address in the source FINS message is correct.	
Attached information	None					
Precautions/Remarks	None					

Event name	Packet Discarded		Event code	80100000 hex		
Meaning	One or more packets were discarded.					
Source	PLC Function Module		Source details	None	Detection timing	At FINS message reception
Error attributes	Level	Observation	Recovery	---	Log category	System
Effects	User program	Continues.	Operation	Not affected.		
System-defined variables	Variable	Data type		Name		
	None	---		---		
Cause and correction	Assumed cause	Correction		Prevention		
	A FINS response addressed to the CPU Unit was received.	Correct the contents of the FINS message at the source.		Set the FINS messages correctly.		
	The send designation Unit for the FINS response does not exist.					
Attached information	Attached information 1: Cause of packet discard <ul style="list-style-type: none"> • (01 hex: FINS response addressed to CPU Unit received, • 02 hex: Response send failed) 					
Precautions/Remarks	None					

Event name	Packet Discarded		Event code	80110000 hex		
Meaning	One or more packets were discarded.					
Source	PLC Function Module		Source details	None	Detection timing At FINS message reception	
Error attributes	Level	Observation	Recovery	---	Log category System	
Effects	User program	Continues.	Operation	Not affected.		
System-defined variables	Variable	Data type		Name		
	None	---		---		
Cause and correction	Assumed cause		Correction		Prevention	
	1. An attempt was made to send a FINS response with over 2002 bytes.		Do not send a FINS response with over 2002 bytes.		Set the FINS message at the source correctly.	
	2. An attempt was made to route a FINS response with over 2002 bytes.					
	3. Packet was received with a No Such Unit routing error.		Check the FINS message at the source and correct the unit number in the response frame or a command frame that does not require a response.			
	4. Packet was received with a Routing Error routing error.		Check the FINS message at the source and correct the unit number in the response frame or a command frame that does not require a response to a unit number that is in the routing table.			
	5. Packet was received with a Routing Table Not Registered routing error.		Check the FINS message at the source, and correct the routing table include the network address of the destination network.			
	6. Packet was received with an Event Area Size Over Limit routing error.		Check the FINS message at the source and correct the event area size in the response frame or a command frame that does not require a response so that it does not exceed the limit.			
	7. There is insufficient space in the internal buffer.		Reduce the frequency of sending FINS messages at the source.			Keep the frequency of sending FINS messages as low as possible.
	8. FINS message routing failed because the communications load is too high.					
Attached information	Attached information 1: Cause of discarding packets 1: 01 hex, 2: 02 hex, 3: 03 hex, 4: 04 hex, 5: 05 hex, 6: 06 hex, 7: 07 hex, 8: 08 hex The numbers refer to the numbers of the above causes.					
Precautions/Remarks	None					

Event name	Packet Discarded		Event code	80120000 hex		
Meaning	One or more packets were discarded.					
Source	PLC Function Module		Source details	None	Detection timing	At FINS message reception
Error attributes	Level	Observation	Recovery	---	Log category	System
Effects	User program	Continues.	Operation	Not affected.		
System-defined variables	Variable	None		Data type	---	
Cause and correction	Assumed cause	Correction		Prevention		
	1. A FINS response was received with the destination network address (DNA) set to the local network and the destination node address (DA1) not set to the local node.	Correct the IP address table settings.		Make sure that the IP address table settings are correct.		
	2. A FINS command or response was received with a hub network address specification for which the destination network address (DNA) was greater than or equal to 80 hex.	Correct the FINS message at the source so that the hub network address specification does not specify a destination network address (DNA) that is greater than or equal to 80 hex.		Make sure that the FINS message at the source does not have a hub network address specification that specifies a destination network address (DNA) that is greater than or equal to 80 hex.		
	3. There is insufficient space in the internal buffer.	Reduce the frequency of sending FINS messages at the source.		Keep the frequency of sending FINS messages as low as possible.		
	4. A FINS command that does not have the minimum command length was received.	Correct the FINS command at the source so that it has at least the minimum command length.		Set the FINS commands at the sources so that they have at least the minimum command length.		
	5. A FINS command that exceeded the maximum command length was received.	Correct the FINS command at the source so that it does not exceed the maximum command length.		Set the FINS commands at the sources so that they do not exceed the maximum command length.		
	6. Sending packets failed.	If the destination node is not in the network, add it to the network.		Confirm that the destination node is in the network.		
	7. FINS message routing failed because the communications load is too high. Or a command that was addressed to the built-in EtherNet/IP port was received with the source network address (SNA) set to 0.	Reduce the frequency of sending FINS messages at the source. Or, correct the source network address (SNA) in the source FINS message.		Keep the frequency of sending FINS messages as low as possible. Or, set the correct source network address (SNA) in the source FINS message.		
	8. A FINS response that was addressed to the built-in EtherNet/IP port was received.	Correct the contents of the FINS message at the source.		Set the FINS messages correctly.		
	9. A FINS response or a command for which a response is not required was received when the routing tables were not registered.	Register the routing tables.		Register the routing tables.		
A: A FINS response or a command for which a response is not required was received when there was an error in the routing tables.	Register the routing tables again. If there is an error in the routing tables, there will be an Illegal User Program/Controller Configurations and Setup (10250000 hex) error.		None			
B: A FINS response or a command for which a response is not required was received that exceeded the number of relay points.	Increase the set value of the gateway counter in the routing table at the source.		Set the gateway counter in the routing table at the source so that it is suitable for the system configuration.			

	C: Transmission is not possible because the destination address is not set in the routing tables.	Register the destination address in the routing tables.	Register the destination address in the routing tables.
	D: Routing is not possible because the FINS node address setting in the Built-in EtherNet/IP Port Settings is set to 0 or 255.	Set the FINS node address in the Built-in EtherNet/IP Port Settings to any value other than 0 or 255 from the Sysmac Studio.	If you set the lower eight bits of the IP address in the TCP/IP Settings in the Built-in EtherNet/IP Port Settings to 0 or 255, set the IP Address-FINS Address Conversion Method to any setting other than Automatic Generation.
Attached information	Attached information 1: Cause of discarding packets 1: 01 hex, 2: 02 hex, 3: 03 hex, 4: 04 hex, 5: 05 hex, 6: 06 hex, 7: 07 hex, 8: 08 hex, 9: 09 hex, A: 0A hex, B: 0B hex, C: 0C hex, D: 0D hex The numbers correspond to the above cause numbers.		
Precautions/Remarks	None		

Instructions

This section provides detailed information on errors (events) that occur for instructions. The lower four digits of the event code represents the error code (ErrorID) for the instruction. For descriptions of an error code, refer to the description of the corresponding event code. For example, when the error code of the instruction is 16#0400, refer to the description of event code, 54010400 hex.

Event codes for instructions are supported by CPU Units with unit version 1.02 or later.

Event name	Firmware Error		Event code	54010415 hex	
Meaning	An error was detected when an instruction was executed.				
Source	PLC Function Module		Source details	Instruction	Detection timing At instruction execution
Error attributes	Level	Partial fault	Recovery	The error cannot be reset.	Log category System
Effects	User program	Continues.	Operation	The relevant instruction will end according to specifications.	
System-defined variables	Variable	Data type		Name	
	None	---		---	
Cause and correction	Assumed cause		Correction		Prevention
	An error occurred in the software.		Contact your OMRON representative.		None
Attached information	<p>Attached information 1: Error Location</p> <p>Attached Information 2: Usually no information is shown. If it is shown, Error Location Details (Rung Number) is displayed. For a program section, the rung number from the start of the section is given. For ST, the line number is given.</p> <p>Attached information 3: Names of the Instruction and Instruction Instance Where the Error Occurred. If there is more than one possible instruction, information is given on all of them. Nothing is given if the instruction cannot be identified.</p> <p>Attached information 4: Expansion Error Code (ErrorIDEx) is given for instructions that have Expansion Error Codes (ErrorIDEx). 0x00000000 is given for instructions that do not have Expansion Error Codes (ErrorIDEx).</p>				
Precautions/Remarks	If a program is changed after an error occurs, the attached information that is displayed may not be correct.				

Event name	Input Value Out of Range		Event code	54010400 hex	
Meaning	An input parameter for an instruction exceeded the valid range for an input variable. Or, division by an integer of 0 occurred in division or remainder calculations.				
Source	PLC Function Module		Source details	Instruction	Detection timing At instruction execution
Error attributes	Level	Observation	Recovery	---	Log category System
Effects	User program	Continues.	Operation	The relevant instruction will end according to specifications.	
System-defined variables	Variable	Data type		Name	
	None	---		---	
Cause and correction	Assumed cause		Correction		Prevention
	An input parameter for an instruction exceeded the valid range for an input variable. Or, division by an integer of 0 occurred in division or remainder calculations.		Check the valid range for the input variables of the instruction. Make sure the input parameters are within the valid range and that no division by 0 or remainder calculation for 0 is performed.		Set the value of the input parameter to the instruction so that the input range is not exceeded.
Attached information	<p>Attached Information 1: Error Location</p> <p>Attached Information 2: Usually no information is shown. If it is shown, Error Location Details (Rung Number) is displayed. For a program section, the rung number from the start of the section is given. For ST, the line number is given.</p> <p>Attached Information 3: Names of the Instruction and Instruction Instance Where the Error Occurred. If there is more than one possible instruction, information is given on all of them. Nothing is given if the instruction cannot be identified.</p> <p>Attached information 4: Expansion Error Code (ErrorIDEx) is given for instructions that have Expansion Error Codes (ErrorIDEx). 0x00000000 is given for instructions that do not have Expansion Error Codes (ErrorIDEx).</p>				
Precautions/Remarks	If a program is changed after an error occurs, the attached information that is displayed may not be correct.				

Event name	Input Mismatch		Event code	54010401 hex	
Meaning	The relationship for the instruction input parameters did not meet required conditions. Or, a numeric value during or after instruction execution did not meet conditions.				
Source	PLC Function Module		Source details	Instruction	Detection timing At instruction execution
Error attributes	Level	Observation	Recovery	---	Log category System
Effects	User program	Continues.	Operation	The relevant instruction will end according to specifications.	
System-defined variables	Variable	Data type		Name	
	None	---		---	
Cause and correction	Assumed cause	Correction		Prevention	
	The relationship for an input parameter did not meet required conditions.	Check the meaning and the relationship of the input variables of the instruction. Correct them so that the relationships for the input parameters meet the required conditions.		Set the input parameter to the instruction so that the value meets the conditions of the relationship for the input variables.	
	A value when processing an instruction or in the result does not meet the conditions.	Check the execution process of the instruction. Set the value of the input parameter so that it does not cause inappropriate processing results.		Check the execution process of the instruction. Set the input parameter so that it does not cause this error during processing.	
Attached information	<p>Attached Information 1: Error Location</p> <p>Attached Information 2: Usually no information is shown. If it is shown, Error Location Details (Rung Number) is displayed. For a program section, the rung number from the start of the section is given. For ST, the line number is given.</p> <p>Attached Information 3: Names of the Instruction and Instruction Instance Where the Error Occurred. If there is more than one possible instruction, information is given on all of them. Nothing is given if the instruction cannot be identified.</p> <p>Attached information 4: Expansion Error Code (ErrorIDEx) is given for instructions that have Expansion Error Codes (ErrorIDEx). 0x00000000 is given for instructions that do not have Expansion Error Codes (ErrorIDEx).</p>				
Precautions/Remarks	If a program is changed after an error occurs, the attached information that is displayed may not be correct.				

Event name	Floating-point Error			Event code	54010402 hex	
Meaning	Non-numeric data was input for a floating-point number input parameter to an instruction.					
Source	PLC Function Module		Source details	Instruction	Detection timing	At instruction execution
Error attributes	Level	Observation	Recovery	---	Log category	System
Effects	User program	Continues.	Operation	The relevant instruction will end according to specifications.		
System-defined variables	Variable	Data type		Name		
	None	---		---		
Cause and correction	Assumed cause		Correction		Prevention	
	Non-numeric data was input for a floating-point number input parameter to an instruction.		Correct the instruction so that a numeric value is input for the floating-point number input parameter.		Use numeric values for the floating-point number input parameters.	
Attached information	<p>Attached Information 1: Error Location</p> <p>Attached Information 2: Usually no information is shown. If it is shown, Error Location Details (Rung Number) is displayed. For a program section, the rung number from the start of the section is given. For ST, the line number is given.</p> <p>Attached Information 3: Names of the Instruction and Instruction Instance Where the Error Occurred. If there is more than one possible instruction, information is given on all of them. Nothing is given if the instruction cannot be identified.</p> <p>Attached information 4: Expansion Error Code (ErrorIDEx) is given for instructions that have Expansion Error Codes (ErrorIDEx). 0x00000000 is given for instructions that do not have Expansion Error Codes (ErrorIDEx).</p>					
Precautions/Remarks	If a program is changed after an error occurs, the attached information that is displayed may not be correct.					

Event name	BCD Error			Event code	54010403 hex	
Meaning	A value that was not BCD was input for a BCD input parameter to an instruction.					
Source	PLC Function Module		Source details	Instruction	Detection timing	At instruction execution
Error attributes	Level	Observation	Recovery	---	Log category	System
Effects	User program	Continues.	Operation	The relevant instruction will end according to specifications.		
System-defined variables	Variable	Data type		Name		
	None	---		---		
Cause and correction	Assumed cause		Correction		Prevention	
	A hexadecimal digit of A, B, C, D, E, or F was input for a BCD input parameter to an instruction.		Correct the instruction so that BCD data is input for the BCD input parameter.		Change the BCD input parameter for the instruction to BCD data.	
Attached information	<p>Attached Information 1: Error Location</p> <p>Attached Information 2: Usually no information is shown. If it is shown, Error Location Details (Rung Number) is displayed. For a program section, the rung number from the start of the section is given. For ST, the line number is given.</p> <p>Attached Information 3: Names of the Instruction and Instruction Instance Where the Error Occurred. If there is more than one possible instruction, information is given on all of them. Nothing is given if the instruction cannot be identified.</p> <p>Attached information 4: Expansion Error Code (ErrorIDEx) is given for instructions that have Expansion Error Codes (ErrorIDEx). 0x00000000 is given for instructions that do not have Expansion Error Codes (ErrorIDEx).</p>					
Precautions/Remarks	If a program is changed after an error occurs, the attached information that is displayed may not be correct.					

Event name	Signed BCD Error		Event code	54010404 hex	
Meaning	An illegal value was input for the most significant digit for a signed BCD input parameter to an instruction.				
Source	PLC Function Module		Source details	Instruction	Detection timing At instruction execution
Error attributes	Level	Observation	Recovery	---	Log category System
Effects	User program	Continues.	Operation	The relevant instruction will end according to specifications.	
System-defined variables	Variable	Data type		Name	
	None	---		---	
Cause and correction	Assumed cause	Correction		Prevention	
	<p>An illegal value was input for the most significant digit for a signed BCD input parameter to an instruction.</p> <ul style="list-style-type: none"> The most-significant digit was 2 to F when <code>_BCD0</code> was specified as the BCD format. The most-significant digit was A, B, C, D, or E when <code>_BCD2</code> was specified as the BCD format. The most-significant digit was B, C, D, or E when <code>_BCD3</code> was specified as the BCD format. 	Correct the instruction so that proper signed BCD data is input for the BCD input parameter.		Set the most-significant digit of the signed BCD data input parameter for the instruction to the correct value.	
Attached information	<p>Attached Information 1: Error Location</p> <p>Attached Information 2: Usually no information is shown. If it is shown, Error Location Details (Rung Number) is displayed. For a program section, the rung number from the start of the section is given. For ST, the line number is given.</p> <p>Attached Information 3: Names of the Instruction and Instruction Instance Where the Error Occurred. If there is more than one possible instruction, information is given on all of them. Nothing is given if the instruction cannot be identified.</p> <p>Attached information 4: Expansion Error Code (ErrorIDEx) is given for instructions that have Expansion Error Codes (ErrorIDEx). 0x00000000 is given for instructions that do not have Expansion Error Codes (ErrorIDEx).</p>				
Precautions/Remarks	If a program is changed after an error occurs, the attached information that is displayed may not be correct.				

Event name	Illegal Bit Position Specified			Event code	54010405 hex	
Meaning	The bit position specified for an instruction was illegal.					
Source	PLC Function Module		Source details	Instruction	Detection timing	At instruction execution
Error attributes	Level	Observation	Recovery	---	Log category	System
Effects	User program	Continues.	Operation	The relevant instruction will end according to specifications.		
System-defined variables	Variable	Data type		Name		
	None	---		---		
Cause and correction	Assumed cause		Correction		Prevention	
	The bit position specified for an instruction exceeds the data range.		Correct the instruction so that the bit position specified for an instruction does not exceed the data range.		Use the instruction so that the bit position specified for an instruction does not exceed the data range.	
Attached information	<p>Attached Information 1: Error Location</p> <p>Attached Information 2: Usually no information is shown. If it is shown, Error Location Details (Rung Number) is displayed. For a program section, the rung number from the start of the section is given. For ST, the line number is given.</p> <p>Attached Information 3: Names of the Instruction and Instruction Instance Where the Error Occurred. If there is more than one possible instruction, information is given on all of them. Nothing is given if the instruction cannot be identified.</p> <p>Attached information 4: Expansion Error Code (ErrorIDEx) is given for instructions that have Expansion Error Codes (ErrorIDEx). 0x00000000 is given for instructions that do not have Expansion Error Codes (ErrorIDEx).</p>					
Precautions/Remarks	If a program is changed after an error occurs, the attached information that is displayed may not be correct.					

Event name	Illegal Data Position Specified			Event code	54010406 hex	
Meaning	A memory address or data size that was specified for the instruction is not suitable.					
Source	PLC Function Module		Source details	Instruction	Detection timing	At instruction execution
Error attributes	Level	Observation	Recovery	---	Log category	System
Effects	User program	Continues.	Operation	The relevant instruction will end according to specifications.		
System-defined variables	Variable	Data type		Name		
	None	---		---		
Cause and correction	Assumed cause		Correction		Prevention	
	A memory address that was specified for an instruction was outside the valid range. The data size that was specified for an instruction exceeded the valid range. For example, the data type of a variable and the data size may not agree.		Correct the instruction so that the data position or data size specified for an instruction does not exceed the range of the data area.		Use the instruction so that the data position or data size specified for an instruction does not exceed the data range.	
Attached information	<p>Attached Information 1: Error Location</p> <p>Attached Information 2: Usually no information is shown. If it is shown, Error Location Details (Rung Number) is displayed. For a program section, the rung number from the start of the section is given. For ST, the line number is given.</p> <p>Attached Information 3: Names of the Instruction and Instruction Instance Where the Error Occurred. If there is more than one possible instruction, information is given on all of them. Nothing is given if the instruction cannot be identified.</p> <p>Attached information 4: Expansion Error Code (ErrorIDEx) is given for instructions that have Expansion Error Codes (ErrorIDEx). 0x00000000 is given for instructions that do not have Expansion Error Codes (ErrorIDEx).</p>					
Precautions/Remarks	If a program is changed after an error occurs, the attached information that is displayed may not be correct.					

Event name	Data Range Exceeded		Event code	54010407 hex		
Meaning	The results of instruction processing exceeded the data area range of the output parameter.					
Source	PLC Function Module		Source details	Instruction	Detection timing	At instruction execution
Error attributes	Level	Observation	Recovery	---	Log category	System
Effects	User program	Continues.	Operation	The relevant instruction will end according to specifications.		
System-defined variables	Variable	Data type		Name		
	None	---		---		
Cause and correction	Assumed cause		Correction		Prevention	
	The results of instruction processing, such as the number of array elements, exceeded the data area range of the output parameter.		Correct the input parameters so that the processing result of the instruction does not exceed the range of the data area of the output parameter.		Set the input parameter so that the processing result of the instruction does not exceed the range of the data area of the output parameter.	
Attached information	<p>Attached Information 1: Error Location</p> <p>Attached Information 2: Usually no information is shown. If it is shown, Error Location Details (Rung Number) is displayed. For a program section, the rung number from the start of the section is given. For ST, the line number is given.</p> <p>Attached Information 3: Names of the Instruction and Instruction Instance Where the Error Occurred. If there is more than one possible instruction, information is given on all of them. Nothing is given if the instruction cannot be identified.</p> <p>Attached information 4: Expansion Error Code (ErrorIDEx) is given for instructions that have Expansion Error Codes (ErrorIDEx). 0x00000000 is given for instructions that do not have Expansion Error Codes (ErrorIDEx).</p>					
Precautions/Remarks	If a program is changed after an error occurs, the attached information that is displayed may not be correct.					

Event name	No Errors to Clear		Event code	54010409 hex		
Meaning	An instruction to clear a Controller error was executed when there was no error in the Controller.					
Source	PLC Function Module		Source details	Instruction	Detection timing	At instruction execution
Error attributes	Level	Observation	Recovery	---	Log category	System
Effects	User program	Continues.	Operation	The relevant instruction will end according to specifications. The output or Unit operation is not affected.		
System-defined variables	Variable	Data type		Name		
	None	---		---		
Cause and correction	Assumed cause		Correction		Prevention	
	An instruction to clear a Controller error was executed when there was no error in the Controller.		Correct the program so that the instruction is executed when there is a Controller error.		Write the program so that the instruction is executed when there is a Controller error.	
Attached information	<p>Attached Information 1: Error Location</p> <p>Attached Information 2: Usually no information is shown. If it is shown, Error Location Details (Rung Number) is displayed. For a program section, the rung number from the start of the section is given. For ST, the line number is given.</p> <p>Attached Information 3: Names of the Instruction and Instruction Instance Where the Error Occurred. If there is more than one possible instruction, information is given on all of them. Nothing is given if the instruction cannot be identified.</p> <p>Attached information 4: Expansion Error Code (ErrorIDEx) is given for instructions that have Expansion Error Codes (ErrorIDEx). 0x00000000 is given for instructions that do not have Expansion Error Codes (ErrorIDEx).</p>					
Precautions/Remarks	If a program is changed after an error occurs, the attached information that is displayed may not be correct.					

Event name	No User Errors to Clear		Event code	5401040B hex	
Meaning	An instruction to clear user-defined errors was executed when there was no user-defined error.				
Source	PLC Function Module		Source details	Instruction	Detection timing At instruction execution
Error attributes	Level	Observation	Recovery	---	Log category System
Effects	User program	Continues.	Operation	The relevant instruction will end according to specifications. The output or Unit operation is not affected.	
System-defined variables	Variable	Data type		Name	
	None	---		---	
Cause and correction	Assumed cause		Correction		Prevention
	An instruction to clear user-defined errors was executed when there was no user-defined error.		Correct the program so that the instruction is executed when there is a user-defined error.		Write the program so that the instruction is executed when there is a user-defined error.
Attached information	<p>Attached Information 1: Error Location</p> <p>Attached Information 2: Usually no information is shown. If it is shown, Error Location Details (Rung Number) is displayed. For a program section, the rung number from the start of the section is given. For ST, the line number is given.</p> <p>Attached Information 3: Names of the Instruction and Instruction Instance Where the Error Occurred. If there is more than one possible instruction, information is given on all of them. Nothing is given if the instruction cannot be identified.</p> <p>Attached information 4: Expansion Error Code (ErrorIDEx) is given for instructions that have Expansion Error Codes (ErrorIDEx). 0x00000000 is given for instructions that do not have Expansion Error Codes (ErrorIDEx).</p>				
Precautions/Remarks	If a program is changed after an error occurs, the attached information that is displayed may not be correct.				

Event name	Limit Exceeded for User-defined Errors		Event code	5401040C hex	
Meaning	An attempt was made to use the Create User-defined Error instruction to create more than the maximum number of user-defined errors.				
Source	PLC Function Module		Source details	Instruction	Detection timing At instruction execution
Error attributes	Level	Observation	Recovery	---	Log category System
Effects	User program	Continues.	Operation	The relevant instruction will end according to specifications. The output or Unit operation is not affected.	
System-defined variables	Variable	Data type		Name	
	None	---		---	
Cause and correction	Assumed cause		Correction		Prevention
	An attempt was made to use the Create User-defined Error instruction to create more than the maximum number of user-defined errors.		Execute the Reset User-defined Error instruction. Monitor the number of user-defined errors in the system-defined variable to check the number of user-defined errors.		Write the program so that it checks the number of user-defined errors as a condition to execute the user-defined error instruction.
Attached information	<p>Attached Information 1: Error Location</p> <p>Attached Information 2: Usually no information is shown. If it is shown, Error Location Details (Rung Number) is displayed. For a program section, the rung number from the start of the section is given. For ST, the line number is given.</p> <p>Attached Information 3: Names of the Instruction and Instruction Instance Where the Error Occurred. If there is more than one possible instruction, information is given on all of them. Nothing is given if the instruction cannot be identified.</p> <p>Attached information 4: Expansion Error Code (ErrorIDEx) is given for instructions that have Expansion Error Codes (ErrorIDEx). 0x00000000 is given for instructions that do not have Expansion Error Codes (ErrorIDEx).</p>				
Precautions/Remarks	If a program is changed after an error occurs, the attached information that is displayed may not be correct.				

Event name	Illegal Unit Specified		Event code	5401040D hex		
Meaning	The Unit specified for an instruction does not exist.					
Source	PLC Function Module		Source details	Instruction	Detection timing	At instruction execution
Error attributes	Level	Observation	Recovery	---	Log category	System
Effects	User program	Continues.	Operation	The relevant instruction will end according to specifications. The output or Unit operation is not affected.		
System-defined variables	Variable		Data type		Name	
	None		---		---	
Cause and correction	Assumed cause		Correction		Prevention	
	A Unit that does not exist in the Unit configuration information was specified.		Correct the unit number in the instruction so that it specifies a Unit in the Unit configuration and make sure that the actual Unit exists.		Make sure that unit numbers in instructions specify Units in the Unit configuration and make sure that the actual Units exist.	
A Unit that is in the Unit configuration information was specified, but the Units does not actually exist in the Controller.						
Attached information	<p>Attached Information 1: Error Location</p> <p>Attached Information 2: Usually no information is shown. If it is shown, Error Location Details (Rung Number) is displayed. For a program section, the rung number from the start of the section is given. For ST, the line number is given.</p> <p>Attached Information 3: Names of the Instruction and Instruction Instance Where the Error Occurred. If there is more than one possible instruction, information is given on all of them. Nothing is given if the instruction cannot be identified.</p> <p>Attached information 4: Expansion Error Code (ErrorIDEx) is given for instructions that have Expansion Error Codes (ErrorIDEx). 0x00000000 is given for instructions that do not have Expansion Error Codes (ErrorIDEx).</p>					
Precautions/Remarks	If a program is changed after an error occurs, the attached information that is displayed may not be correct.					

Event name	Unit Restart Failed		Event code	5401040F hex		
Meaning	Restarting a Special I/O Unit or CPU Bus Unit failed.					
Source	PLC Function Module		Source details	Instruction	Detection timing	At instruction execution
Error attributes	Level	Observation	Recovery	---	Log category	System
Effects	User program	Continues.	Operation	The relevant instruction will end according to specifications. The output or Unit operation is not affected.		
System-defined variables	Variable		Data type		Name	
	None		---		---	
Cause and correction	Assumed cause		Correction		Prevention	
	The Special I/O Unit or CPU Bus Unit is processing data.		Wait a few moments and then restart the Special I/O Unit or CPU Bus Unit.		Check to be sure that Special I/O Units and CPU Bus Units are not processing data before restarting them from the user program.	
Attached information	<p>Attached Information 1: Error Location</p> <p>Attached Information 2: Usually no information is shown. If it is shown, Error Location Details (Rung Number) is displayed. For a program section, the rung number from the start of the section is given. For ST, the line number is given.</p> <p>Attached Information 3: Names of the Instruction and Instruction Instance Where the Error Occurred. If there is more than one possible instruction, information is given on all of them. Nothing is given if the instruction cannot be identified.</p> <p>Attached information 4: Expansion Error Code (ErrorIDEx) is given for instructions that have Expansion Error Codes (ErrorIDEx). 0x00000000 is given for instructions that do not have Expansion Error Codes (ErrorIDEx).</p>					
Precautions/Remarks	If a program is changed after an error occurs, the attached information that is displayed may not be correct.					

Event name	Text String Format Error		Event code	54010410 hex	
Meaning	The text string input to an instruction is not correct.				
Source	PLC Function Module		Source details	Instruction	Detection timing At instruction execution
Error attributes	Level	Observation	Recovery	---	Log category System
Effects	User program	Continues.	Operation	The relevant instruction will end according to specifications.	
System-defined variables	Variable	Data type		Name	
	None	---		---	
Cause and correction	Assumed cause		Correction		Prevention
	The text string that is input to the instruction for conversion to a number does not represent a number or it does not represent a positive number.		Correct the text string so that it is properly formatted for the instruction.		When converting a text string to a number, make sure that the text string that is input to the instruction represents a number. If the number must be positive, make sure the text string represents a positive number.
	The input text string does not end in NULL.		Correct the text string that is input to the instruction so that it ends in NULL.		When converting a text string to a number, make sure that the text string that is input to the instruction ends in NULL.
Attached information	<p>Attached Information 1: Error Location</p> <p>Attached Information 2: Usually no information is shown. If it is shown, Error Location Details (Rung Number) is displayed. For a program section, the rung number from the start of the section is given. For ST, the line number is given.</p> <p>Attached Information 3: Names of the Instruction and Instruction Instance Where the Error Occurred. If there is more than one possible instruction, information is given on all of them. Nothing is given if the instruction cannot be identified.</p> <p>Attached information 4: Expansion Error Code (ErrorIDEx) is given for instructions that have Expansion Error Codes (ErrorIDEx). 0x00000000 is given for instructions that do not have Expansion Error Codes (ErrorIDEx).</p>				
Precautions/Remarks	If a program is changed after an error occurs, the attached information that is displayed may not be correct.				

3 Error Descriptions and Corrections

Event name	Illegal Program Specified		Event code	54010411 hex		
Meaning	The program specified for an instruction does not exist.					
Source	PLC Function Module		Source details	Instruction	Detection timing	At instruction execution
Error attributes	Level	Observation	Recovery	---	Log category	System
Effects	User program	Continues.	Operation	The relevant instruction will end according to specifications.		
System-defined variables	Variable	Data type		Name		
	None	---		---		
Cause and correction	Assumed cause		Correction		Prevention	
	The program specified by the function does not exist (e.g., it was deleted).		Make sure that the program that is specified by the instruction exists. Or, add the program that is specified for the instruction.		Make sure that the programs that are specified by instructions exist. Be careful not to delete any programs that are used by instructions.	
Attached information	<p>Attached Information 1: Error Location</p> <p>Attached Information 2: Usually no information is shown. If it is shown, Error Location Details (Rung Number) is displayed. For a program section, the rung number from the start of the section is given. For ST, the line number is given.</p> <p>Attached Information 3: Names of the Instruction and Instruction Instance Where the Error Occurred. If there is more than one possible instruction, information is given on all of them. Nothing is given if the instruction cannot be identified.</p> <p>Attached information 4: Expansion Error Code (ErrorIDEx) is given for instructions that have Expansion Error Codes (ErrorIDEx). 0x00000000 is given for instructions that do not have Expansion Error Codes (ErrorIDEx).</p>					
Precautions/Remarks	If a program is changed after an error occurs, the attached information that is displayed may not be correct.					

Event name	Undefined CJ-series Memory Address		Event code	54010413 hex		
Meaning	The required specification is missing for a variable for which CJ-series Unit memory must be specified.					
Source	PLC Function Module		Source details	Instruction	Detection timing	At instruction execution
Error attributes	Level	Observation	Recovery	---	Log category	System
Effects	User program	Continues.	Operation	The relevant instruction will end according to specifications.		
System-defined variables	Variable	Data type		Name		
	None	---		---		
Cause and correction	Assumed cause		Correction		Prevention	
	The required AT specification is missing for a variable for which CJ-series Unit memory must be specified.		Correct the program so that it uses the AT specification to specify CJ-series Unit memory when doing so is required by the variable.		Write the program so that it uses an AT designation to specify CJ-series Unit memory when doing so is required by the variable.	
Attached information	<p>Attached Information 1: Error Location</p> <p>Attached Information 2: Usually no information is shown. If it is shown, Error Location Details (Rung Number) is displayed. For a program section, the rung number from the start of the section is given. For ST, the line number is given.</p> <p>Attached Information 3: Names of the Instruction and Instruction Instance Where the Error Occurred. If there is more than one possible instruction, information is given on all of them. Nothing is given if the instruction cannot be identified.</p> <p>Attached information 4: Expansion Error Code (ErrorIDEx) is given for instructions that have Expansion Error Codes (ErrorIDEx). 0x00000000 is given for instructions that do not have Expansion Error Codes (ErrorIDEx).</p>					
Precautions/Remarks	If a program is changed after an error occurs, the attached information that is displayed may not be correct.					

Event name	Stack Underflow		Event code	54010414 hex	
Meaning	There is no data in a stack.				
Source	PLC Function Module		Source details	Instruction	Detection timing At instruction execution
Error attributes	Level	Observation	Recovery	---	Log category System
Effects	User program	Continues.	Operation	The relevant instruction will end according to specifications.	
System-defined variables	Variable	Data type		Name	
	None	---		---	
Cause and correction	Assumed cause		Correction		Prevention
	An attempt was made to read data from a stack that contains no data.		Correct the program so that the data is read only after it is stored in the stack.		Correct the program so that the data is read only after it is stored in the stack.
Attached information	<p>Attached Information 1: Error Location</p> <p>Attached Information 2: Usually no information is shown. If it is shown, Error Location Details (Rung Number) is displayed. For a program section, the rung number from the start of the section is given. For ST, the line number is given.</p> <p>Attached Information 3: Names of the Instruction and Instruction Instance Where the Error Occurred. If there is more than one possible instruction, information is given on all of them. Nothing is given if the instruction cannot be identified.</p> <p>Attached information 4: Expansion Error Code (ErrorIDEx) is given for instructions that have Expansion Error Codes (ErrorIDEx). 0x00000000 is given for instructions that do not have Expansion Error Codes (ErrorIDEx).</p>				
Precautions/Remarks	If a program is changed after an error occurs, the attached information that is displayed may not be correct.				

Event name	Illegal Number of Array Elements or Dimensions		Event code	54010416 hex	
Meaning	The valid range was exceeded for the number of array elements or dimensions in an array I/O parameter for an instruction.				
Source	PLC Function Module		Source details	Instruction	Detection timing At instruction execution
Error attributes	Level	Observation	Recovery	---	Log category System
Effects	User program	Continues.	Operation	The relevant instruction will end according to specifications.	
System-defined variables	Variable	Data type		Name	
	None	---		---	
Cause and correction	Assumed cause		Correction		Prevention
	The valid range was exceeded for the number of array elements or dimensions in an array I/O parameter for an instruction.		Correct the instruction so that the valid range for the number of array elements or dimensions in an array I/O parameter is not exceeded.		Correct the instruction so that the valid range for the number of array elements or dimensions in an array I/O parameter is not exceeded.
Attached information	<p>Attached Information 1: Error Location</p> <p>Attached Information 2: Usually no information is shown. If it is shown, Error Location Details (Rung Number) is displayed. For a program section, the rung number from the start of the section is given. For ST, the line number is given.</p> <p>Attached Information 3: Names of the Instruction and Instruction Instance Where the Error Occurred. If there is more than one possible instruction, information is given on all of them. Nothing is given if the instruction cannot be identified.</p> <p>Attached information 4: Expansion Error Code (ErrorIDEx) is given for instructions that have Expansion Error Codes (ErrorIDEx). 0x00000000 is given for instructions that do not have Expansion Error Codes (ErrorIDEx).</p>				
Precautions/Remarks	If a program is changed after an error occurs, the attached information that is displayed may not be correct.				

3 Error Descriptions and Corrections

Event name	Specified Task Does Not Exist		Event code	54010417 hex		
Meaning	The task specified for the instruction does not exist.					
Source	PLC Function Module		Source details	Instruction	Detection timing	At instruction execution
Error attributes	Level	Observation	Recovery	---	Log category	System
Effects	User program	Continues.	Operation	The relevant instruction will end according to specifications.		
System-defined variables	Variable	Data type		Name		
	None	---		---		
Cause and correction	Assumed cause		Correction		Prevention	
	The specified task does not exist.		Correct the user program so that it specifies an existing task.		Write the user program so that it specifies only existing tasks.	
Attached information	<p>Attached Information 1: Error Location</p> <p>Attached Information 2: Usually no information is shown. If it is shown, Error Location Details (Rung Number) is displayed. For a program section, the rung number from the start of the section is given. For ST, the line number is given.</p> <p>Attached Information 3: Names of the Instruction and Instruction Instance Where the Error Occurred. If there is more than one possible instruction, information is given on all of them. Nothing is given if the instruction cannot be identified.</p> <p>Attached information 4: Expansion Error Code (ErrorIDEx) is given for instructions that have Expansion Error Codes (ErrorIDEx). 0x00000000 is given for instructions that do not have Expansion Error Codes (ErrorIDEx).</p>					
Precautions/Remarks	If a program is changed after an error occurs, the attached information that is displayed may not be correct.					

Event name	Unallowed Task Specification		Event code	54010418 hex		
Meaning	An unallowed task was specified for an instruction.					
Source	PLC Function Module		Source details	Instruction	Detection timing	At instruction execution
Error attributes	Level	Observation	Recovery	---	Log category	System
Effects	User program	Continues.	Operation	The relevant instruction will end according to specifications.		
System-defined variables	Variable	Data type		Name		
	None	---		---		
Cause and correction	Assumed cause		Correction		Prevention	
	The local task, the primary periodic task, or a periodic task was specified.		Correct the user program so that it specifies an event task that is not the local task.		Write the user program so that it specifies event tasks that are not the local task.	
Attached information	<p>Attached Information 1: Error Location</p> <p>Attached Information 2: Usually no information is shown. If it is shown, Error Location Details (Rung Number) is displayed. For a program section, the rung number from the start of the section is given. For ST, the line number is given.</p> <p>Attached Information 3: Names of the Instruction and Instruction Instance Where the Error Occurred. If there is more than one possible instruction, information is given on all of them. Nothing is given if the instruction cannot be identified.</p> <p>Attached information 4: Expansion Error Code (ErrorIDEx) is given for instructions that have Expansion Error Codes (ErrorIDEx). 0x00000000 is given for instructions that do not have Expansion Error Codes (ErrorIDEx).</p>					
Precautions/Remarks	If a program is changed after an error occurs, the attached information that is displayed may not be correct.					

Event name	Incorrect Data Type			Event code	54010419 hex	
Meaning	A data type that cannot be used for an instruction is specified for an input or in-out variable.					
Source	PLC Function Module		Source details	Instruction	Detection timing	At instruction execution
Error attributes	Level	Observation	Recovery	---	Log category	System
Effects	User program	Continues.	Operation	The relevant instruction will end according to specifications.		
System-defined variables	Variable	Data type		Name		
	None	---		---		
Cause and correction	Assumed cause		Correction		Prevention	
	A data type that cannot be used for an instruction is specified for an input or in-out variable.		Check the data types of the input and in-out variables of the instruction and correct them to correct data types.		Check the allowed data types for input and in-out variables for the instruction and use correct data types.	
Attached information	<p>Attached Information 1: Error Location</p> <p>Attached Information 2: Usually no information is shown. If it is shown, Error Location Details (Rung Number) is displayed. For a program section, the rung number from the start of the section is given. For ST, the line number is given.</p> <p>Attached Information 3: Names of the Instruction and Instruction Instance Where the Error Occurred. If there is more than one possible instruction, information is given on all of them. Nothing is given if the instruction cannot be identified.</p> <p>Attached information 4: Expansion Error Code (ErrorIDEx) is given for instructions that have Expansion Error Codes (ErrorIDEx). 0x00000000 is given for instructions that do not have Expansion Error Codes (ErrorIDEx).</p>					
Precautions/Remarks	If a program is changed after an error occurs, the attached information that is displayed may not be correct.					

Event name	Multi-execution of Instructions			Event code	5401041A hex	
Meaning	Multi-execution was specified for an instruction that does not support it.					
Source	PLC Function Module		Source details	Instruction	Detection timing	At instruction execution
Error attributes	Level	Observation	Recovery	---	Log category	System
Effects	User program	Continues.	Operation	The relevant instruction will end according to specifications.		
System-defined variables	Variable	Data type		Name		
	None	---		---		
Cause and correction	Assumed cause		Correction		Prevention	
	Execution of an instruction that does not support multi-execution of instructions was specified more than once.		Correct the program so that any instance of an instruction that does not support multi-execution is completed before another instance is executed.		Write the user program so that any instance of an instruction that does not support multi-execution is completed before another instance is executed.	
Attached information	<p>Attached Information 1: Error Location</p> <p>Attached Information 2: Usually no information is shown. If it is shown, Error Location Details (Rung Number) is displayed. For a program section, the rung number from the start of the section is given. For ST, the line number is given.</p> <p>Attached Information 3: Names of the Instruction and Instruction Instance Where the Error Occurred. If there is more than one possible instruction, information is given on all of them. Nothing is given if the instruction cannot be identified.</p> <p>Attached information 4: Expansion Error Code (ErrorIDEx) is given for instructions that have Expansion Error Codes (ErrorIDEx). 0x00000000 is given for instructions that do not have Expansion Error Codes (ErrorIDEx).</p>					
Precautions/Remarks	If a program is changed after an error occurs, the attached information that is displayed may not be correct.					

Event name	Data Capacity Exceeded		Event code	5401041B hex*1	
Meaning	The data that was passed to the instruction was too large to process.				
Source	PLC Function Module		Source details	Instruction	Detection timing At instruction execution
Error attributes	Level	Observation	Recovery	---	Log category System
Effects	User program	Continues.	Operation	The relevant instruction will end according to specifications.	
System-defined variables	Variable	Data type		Name	
	None	---		---	
Cause and correction	Assumed cause		Correction		Prevention
	Data that was larger than the capacity that can be processed was passed to the instruction.		Correct the program so that the size of the data that is passed to the instruction does not exceed the processing capacity.		Make sure that the data that is passed to the instruction is not larger than the processing capacity.
Attached information	<p>Attached Information 1: Error Location</p> <p>Attached Information 2: Usually no information is shown. If it is shown, Error Location Details (Rung Number) is displayed. For a program section, the rung number from the start of the section is given. For ST, the line number is given.</p> <p>Attached Information 3: Names of the Instruction and Instruction Instance Where the Error Occurred. If there is more than one possible instruction, information is given on all of them. Nothing is given if the instruction cannot be identified.</p> <p>Attached information 4: Expansion Error Code (ErrorIDEx) is given for instructions that have Expansion Error Codes (ErrorIDEx). 0x00000000 is given for instructions that do not have Expansion Error Codes (ErrorIDEx).</p>				
Precautions/Remarks	If a program is changed after an error occurs, the attached information that is displayed may not be correct.				

*1. Error code 16#041B occurs for unit version 1.02 or later of the CPU Unit.

Event name	Different Data Sizes		Event code	5401041C hex*1	
Meaning	The size of the data specified for instruction input or in-out data is different from the size of the target parameter.				
Source	PLC Function Module		Source details	Instruction	Detection timing At instruction execution
Error attributes	Level	Observation	Recovery	---	Log category System
Effects	User program	Continues.	Operation	The relevant instruction will end according to specifications.	
System-defined variables	Variable	Data type		Name	
	None	---		---	
Cause and correction	Assumed cause		Correction		Prevention
	Data of a size that is different from the size of the target parameter was specified for the input or in-out data of an instruction.		Check the size of the target parameter and correct the program so that the size of the input data is the same.		Check the size of the target parameter and correct the program so that the size of the input data is the same.
Attached information	<p>Attached Information 1: Error Location</p> <p>Attached Information 2: Usually no information is shown. If it is shown, Error Location Details (Rung Number) is displayed. For a program section, the rung number from the start of the section is given. For ST, the line number is given.</p> <p>Attached Information 3: Names of the Instruction and Instruction Instance Where the Error Occurred. If there is more than one possible instruction, information is given on all of them. Nothing is given if the instruction cannot be identified.</p> <p>Attached information 4: Expansion Error Code (ErrorIDEx) is given for instructions that have Expansion Error Codes (ErrorIDEx). 0x00000000 is given for instructions that do not have Expansion Error Codes (ErrorIDEx).</p>				
Precautions/Remarks	If a program is changed after an error occurs, the attached information that is displayed may not be correct.				

*1. Error code 16#041C occurs for unit version 1.04 or later of the CPU Unit.

Event name	Exceeded Simultaneous Instruction Executed Resources		Event code	5401041D hex*1	
Meaning	The maximum resources that you can use for the relevant instruction group at the same time was exceeded.				
Source	PLC Function Module		Source details	Instruction	Detection timing At instruction execution
Error attributes	Level	Observation	Recovery	---	Log category System
Effects	User program	Continues.	Operation	The relevant instruction will end according to specifications.	
System-defined variables	Variable	Data type		Name	
	None	---		---	
Cause and correction	Assumed cause	Correction		Prevention	
	More than the maximum number of relevant instructions were executed at the same time.	Correct the program so that no more than the maximum number of the relevant instructions are executed at the same time.		Write the program so that no more than the maximum number of the relevant instructions are executed at the same time.	
Attached information	<p>Attached Information 1: Error Location</p> <p>Attached Information 2: Usually no information is shown. If it is shown, Error Location Details (Rung Number) is displayed. For a program section, the rung number from the start of the section is given. For ST, the line number is given.</p> <p>Attached Information 3: Names of the Instruction and Instruction Instance Where the Error Occurred. If there is more than one possible instruction, information is given on all of them. Nothing is given if the instruction cannot be identified.</p> <p>Attached information 4: Expansion Error Code (ErrorIDEx) is given for instructions that have Expansion Error Codes (ErrorIDEx). 0x00000000 is given for instructions that do not have Expansion Error Codes (ErrorIDEx).</p>				
Precautions/Remarks	If a program is changed after an error occurs, the attached information that is displayed may not be correct.				

*1. Error code 16#041D occurs for unit version 1.05 or later of the CPU Unit.

Event name	Failed to Get The Program Hash Code		Event code	54010421 hex*1	
Meaning	Retrieving program hash code failed.				
Source	PLC Function Module		Source details	Instruction	Detection timing At instruction execution
Error attributes	Level	Observation	Recovery	---	Log category System
Effects	User program	Continues.	Operation	The relevant instruction will end according to specifications.	
System-defined variables	Variable	Data type		Name	
	None	---		---	
Cause and correction	Assumed cause		Correction		Prevention
	The transfer of the user program failed.		Transfer the user program again.		None
	The project downloaded to the CPU Unit does not contain the information required for the instruction.		Rebuild the user program and transfer it again.		None
	Non-volatile memory failure		If the error persists even after you make the above corrections, replace the CPU Unit.		None
Attached information	<p>Attached information 1: Error Location</p> <p>Attached Information 2: Usually no information is shown. If it is shown, Error Location Details (Rung Number) is displayed. For a program section, the rung number from the start of the section is given. For ST, the line number is given.</p> <p>Attached information 3: Names of the Instruction and Instruction Instance Where the Error Occurred. If there is more than one possible instruction, information is given on all of them. Nothing is given if the instruction cannot be identified.</p> <p>Attached information 4: Expansion Error Code (ErrorIDEx) for the instruction which has an Expansion Error Code (ErrorIDEx). For the instruction without an Expansion Error Code (ErrorIDEx), 0x00000000 is given.</p>				
Precautions/Remarks	If a program is changed after an error occurs, the attached information that is displayed may not be correct.				

*1. This event code (16#0421) occurs for the following CPU Units.

- NJ-series, NX102, NX1P2 CPU Unit: Version 1.50 or later
- NX701 CPU Unit: Version 1.32 or later

Event name	FINS Error		Event code	54010800 hex		
Meaning	An error occurred when a FINS command was sent or received.					
Source	PLC Function Module		Source details	Instruction	Detection timing	At instruction execution
Error attributes	Level	Observation	Recovery	---	Log category	System
Effects	User program	Continues.	Operation	The relevant instruction will end according to specifications.		
System-defined variables	Variable	Data type		Name		
	None	---		---		
Cause and correction	Assumed cause		Correction		Prevention	
	An error occurred when a FINS command was sent or received.		Check the value of the <i>ErrorIDEx</i> output variable from the instruction and refer to the description in this manual for the expansion error code (<i>ErrorIDEx</i>) with the same value for the instruction.		Read the description of <i>ErrorIDEx</i> in advance for the instruction and program correctly.	
Attached information	<p>Attached Information 1: Error Location</p> <p>Attached Information 2: Error Location Details (Rung Number). For a program section, the rung number from the start of the section is given. For ST, the line number is given.</p> <p>Attached Information 3: Names of the Instruction and Instruction Instance Where the Error Occurred. If there is more than one possible instruction, information is given on all of them. Nothing is given if the instruction cannot be identified.</p> <p>Attached Information 4: Expansion Error Code (<i>ErrorIDEx</i>)</p>					
Precautions/Remarks	If a program is changed after an error occurs, the attached information that is displayed may not be correct.					

Event name	FINS Port Already in Use		Event code	54010801 hex		
Meaning	The FINS port is being used.					
Source	PLC Function Module		Source details	Instruction	Detection timing	At instruction execution
Error attributes	Level	Observation	Recovery	---	Log category	System
Effects	User program	Continues.	Operation	The relevant instruction will end according to specifications. The communications output or Unit operation is not affected.		
System-defined variables	Variable	Data type		Name		
	None	---		---		
Cause and correction	Assumed cause		Correction		Prevention	
	The FINS port is being used.		Correct the program by inserting <i>_Port_isAvailable</i> in a N.O. input condition.		Insert <i>_Port_isAvailable</i> in a N.O. input condition when you create the program.	
Attached information	<p>Attached Information 1: Error Location</p> <p>Attached Information 2: Error Location Details (Rung Number). For a program section, the rung number from the start of the section is given. For ST, the line number is given.</p> <p>Attached Information 3: Names of the Instruction and Instruction Instance Where the Error Occurred. If there is more than one possible instruction, information is given on all of them. Nothing is given if the instruction cannot be identified.</p> <p>Attached information 4: Expansion Error Code (<i>ErrorIDEx</i>) is given for instructions that have Expansion Error Codes (<i>ErrorIDEx</i>). 0x00000000 is given for instructions that do not have Expansion Error Codes (<i>ErrorIDEx</i>).</p>					
Precautions/Remarks	If a program is changed after an error occurs, the attached information that is displayed may not be correct.					

Event name	Illegal Serial Communications Mode		Event code	54010C00 hex	
Meaning	The Serial Communications Unit is not in the serial communications mode required to execute an instruction.				
Source	PLC Function Module		Source details	Instruction	Detection timing At instruction execution
Error attributes	Level	Observation	Recovery	---	Log category System
Effects	User program	Continues.	Operation	The relevant instruction will end according to specifications. The communications output will follow the specifications of the instruction. The operation of the Unit is not affected.	
System-defined variables	Variable	Data type		Name	
	None	---		---	
Cause and correction	Assumed cause		Correction		Prevention
	The serial communications port for the Serial Communications Unit is not set to the mode expected by the instruction.		Change to the serial communications mode required to execute the instruction. Or, correct the program so that it only uses instructions that can be executed in the current mode.		Set the Serial Communications Unit to the serial communications mode required to execute the instruction. Or, correct the program so that it only uses instructions that can be executed in the currently set mode.
Attached information	<p>Attached Information 1: Error Location</p> <p>Attached Information 2: Error Location Details (Rung Number). For a program section, the rung number from the start of the section is given. For ST, the line number is given.</p> <p>Attached Information 3: Names of the Instruction and Instruction Instance Where the Error Occurred. If there is more than one possible instruction, information is given on all of them. Nothing is given if the instruction cannot be identified.</p> <p>Attached information 4: Expansion Error Code (ErrorIDEx) is given for instructions that have Expansion Error Codes (ErrorIDEx). 0x00000000 is given for instructions that do not have Expansion Error Codes (ErrorIDEx).</p>				
Precautions/Remarks	If a program is changed after an error occurs, the attached information that is displayed may not be correct.				

Event name	Full Reception Buffer		Event code	54010C03 hex*1		
Meaning	The reception buffer is full.					
Source	PLC Function Module		Source details	Instruction	Detection timing	At instruction execution
Error attributes	Level	Observation	Recovery	---	Log category	System
Effects	User program	Continues.	Operation	The relevant instruction will end according to specifications. Even if the instruction was ended by this error, the received data is saved partially for the amount the receive data storage can store.		
System-defined variables	Variable	Data type		Name		
	None	---		---		
Cause and correction	Assumed cause		Correction		Prevention	
	<p>The reception buffer is full due to the following causes.</p> <ul style="list-style-type: none"> • The transmission frequency of the remote device is high. • The baud rate is too high. • The reception processing frequency from the buffer is low. 		<p>Take either or all of the following correction measures and ensure that the reception buffer will not be full.</p> <ul style="list-style-type: none"> • Lower the transmission frequency of the remote device. • Decrease the baud rate. • Increase the reception processing frequency from the buffer. 		<p>Consider the following four factors and ensure that the reception buffer will not be full.</p> <ul style="list-style-type: none"> • Transmission frequency of the remote device • Baud rate • Reception processing frequency from the buffer • Using flow control 	
Attached information	<p>Attached Information 1: Error Location</p> <p>Attached Information 2: Error Location Details (Rung Number). For a program section, the rung number from the start of the section is given. For ST, the line number is given.</p> <p>Attached Information 3: Names of the Instruction and Instruction Instance Where the Error Occurred. If there is more than one possible instruction, information is given on all of them. Nothing is given if the instruction cannot be identified.</p> <p>Attached information 4: Expansion Error Code (ErrorIDEx) is given for instructions that have Expansion Error Codes (ErrorIDEx). 0x00000000 is given for instructions that do not have Expansion Error Codes (ErrorIDEx).</p>					
Precautions/Remarks	If a program is changed after an error occurs, the attached information that is displayed may not be correct.					

*1. Error code 16#0C03 occurs for unit version 1.11 or later of the CPU Unit.

Event name	Multi-execution of Ports		Event code	54010C04 hex*1	
Meaning	The serial communications instructions that cannot be executed simultaneously were executed.				
Source	PLC Function Module		Source details	Instruction	Detection timing At instruction execution
Error attributes	Level	Observation	Recovery	---	Log category System
Effects	User program	Continues.	Operation	The relevant instruction will end according to specifications. The communications output will follow the specifications of the instruction.	
System-defined variables	Variable	Data type		Name	
	None	---		---	
Cause and correction	Assumed cause		Correction		Prevention
	An instruction was executed while another instruction that cannot be executed at the same time with the former instruction was executed.		Correct the program so that instructions that cannot be executed at the same time are mutually excluded.		Create a program so that instructions that cannot be executed at the same time are mutually excluded.
Attached information	<p>Attached Information 1: Error Location</p> <p>Attached Information 2: Error Location Details (Rung Number). For a program section, the rung number from the start of the section is given. For ST, the line number is given.</p> <p>Attached Information 3: Names of the Instruction and Instruction Instance Where the Error Occurred. If there is more than one possible instruction, information is given on all of them. Nothing is given if the instruction cannot be identified.</p> <p>Attached information 4: Expansion Error Code (ErrorIDEx) is given for instructions that have Expansion Error Codes (ErrorIDEx). 0x00000000 is given for instructions that do not have Expansion Error Codes (ErrorIDEx).</p>				
Precautions/Remarks	<ul style="list-style-type: none"> • If a program is changed after an error occurs, the attached information that is displayed may not be correct. • Refer to individual instruction descriptions for the serial communications instructions that cannot be executed at the same time. 				

*1. Error code 16#0C04 occurs for unit version 1.11 or later of the CPU Unit.

Event name	Parity Error		Event code	54010C05 hex*1		
Meaning	A parity error occurred in the data received.					
Source	PLC Function Module		Source details	Instruction	Detection timing	At instruction execution
Error attributes	Level	Observation	Recovery	---	Log category	System
Effects	User program	Continues.	Operation	The relevant instruction will end according to specifications. The communications output will follow the specifications of the instruction.		
System-defined variables	Variable	Data type		Name		
	None	---		---		
Cause and correction	Assumed cause		Correction		Prevention	
	The communications settings or baud rate settings are not compatible with the remote device.		Make the communications settings and baud rate settings compatible with the remote device.		Make the communications settings and baud rate settings compatible with the remote device.	
	Noise		Implement noise countermeasures.		Implement noise countermeasures.	
Attached information	<p>Attached Information 1: Error Location</p> <p>Attached Information 2: Error Location Details (Rung Number). For a program section, the rung number from the start of the section is given. For ST, the line number is given.</p> <p>Attached Information 3: Names of the Instruction and Instruction Instance Where the Error Occurred. If there is more than one possible instruction, information is given on all of them. Nothing is given if the instruction cannot be identified.</p> <p>Attached information 4: Expansion Error Code (ErrorIDEx) is given for instructions that have Expansion Error Codes (ErrorIDEx). 0x00000000 is given for instructions that do not have Expansion Error Codes (ErrorIDEx).</p>					
Precautions/Remarks	If a program is changed after an error occurs, the attached information that is displayed may not be correct.					

*1. Error code 16#0C05 occurs for unit version 1.11 or later of the CPU Unit.

Event name	Framing Error		Event code	54010C06 hex*1		
Meaning	A framing error occurred in the data received.					
Source	PLC Function Module		Source details	Instruction	Detection timing	At instruction execution
Error attributes	Level	Observation	Recovery	---	Log category	System
Effects	User program	Continues.	Operation	The relevant instruction will end according to specifications. The communications output will follow the specifications of the instruction.		
System-defined variables	Variable	Data type		Name		
	None	---		---		
Cause and correction	Assumed cause		Correction		Prevention	
	The communications settings or baud rate settings are not compatible with the remote device.		Make the communications settings and baud rate settings compatible with the remote device.		Make the communications settings and baud rate settings compatible with the remote device.	
	Noise		Implement noise countermeasures.		Implement noise countermeasures.	
Attached information	<p>Attached Information 1: Error Location</p> <p>Attached Information 2: Error Location Details (Rung Number). For a program section, the rung number from the start of the section is given. For ST, the line number is given.</p> <p>Attached Information 3: Names of the Instruction and Instruction Instance Where the Error Occurred. If there is more than one possible instruction, information is given on all of them. Nothing is given if the instruction cannot be identified.</p> <p>Attached information 4: Expansion Error Code (ErrorIDEx) is given for instructions that have Expansion Error Codes (ErrorIDEx). 0x00000000 is given for instructions that do not have Expansion Error Codes (ErrorIDEx).</p>					
Precautions/Remarks	If a program is changed after an error occurs, the attached information that is displayed may not be correct.					

*1. Error code 16#0C06 occurs for unit version 1.11 or later of the CPU Unit.

Event name	Overrun Error		Event code	54010C07 hex*1	
Meaning	An overrun error occurred in the data received.				
Source	PLC Function Module		Source details	Instruction	Detection timing At instruction execution
Error attributes	Level	Observation	Recovery	---	Log category System
Effects	User program	Continues.	Operation	The relevant instruction will end according to specifications. The communications output will follow the specifications of the instruction.	
System-defined variables	Variable	Data type		Name	
	None	---		---	
Cause and correction	Assumed cause		Correction		Prevention
	The next data was received during processing of received data because the baud rate is too high.		Reduce the baud rate.		Reduce the baud rate.
Attached information	<p>Attached Information 1: Error Location</p> <p>Attached Information 2: Error Location Details (Rung Number). For a program section, the rung number from the start of the section is given. For ST, the line number is given.</p> <p>Attached Information 3: Names of the Instruction and Instruction Instance Where the Error Occurred. If there is more than one possible instruction, information is given on all of them. Nothing is given if the instruction cannot be identified.</p> <p>Attached information 4: Expansion Error Code (ErrorIDEx) is given for instructions that have Expansion Error Codes (ErrorIDEx). 0x00000000 is given for instructions that do not have Expansion Error Codes (ErrorIDEx).</p>				
Precautions/Remarks	If a program is changed after an error occurs, the attached information that is displayed may not be correct.				

*1. Error code 16#0C07 occurs for unit version 1.11 or later of the CPU Unit.

Event name	CRC Mismatch		Event code	54010C08 hex*1	
Meaning	The receive data had different CRC.				
Source	PLC Function Module		Source details	Instruction	Detection timing At instruction execution
Error attributes	Level	Observation	Recovery	---	Log category System
Effects	User program	Continues.	Operation	The relevant instruction will end according to specifications. The communications output will follow the specifications of the instruction.	
System-defined variables	Variable	Data type		Name	
	None	---		---	
Cause and correction	Assumed cause		Correction		Prevention
	A wrong message was received.		Correct the CRC generation method for the remote device to be the one as intended.		Confirm the CRC generation method for the remote device to be the one as intended.
	Noise		Receive the data again. Or, implement noise countermeasures.		Implement noise countermeasures.
Attached information	<p>Attached Information 1: Error Location</p> <p>Attached Information 2: Error Location Details (Rung Number). For a program section, the rung number from the start of the section is given. For ST, the line number is given.</p> <p>Attached Information 3: Names of the Instruction and Instruction Instance Where the Error Occurred. If there is more than one possible instruction, information is given on all of them. Nothing is given if the instruction cannot be identified.</p> <p>Attached information 4: Expansion Error Code (ErrorIDEx) is given for instructions that have Expansion Error Codes (ErrorIDEx). 0x00000000 is given for instructions that do not have Expansion Error Codes (ErrorIDEx).</p>				
Precautions/Remarks	If a program is changed after an error occurs, the attached information that is displayed may not be correct.				

*1. Error code 16#0C08 occurs for unit version 1.11 or later of the CPU Unit.

Event name	Serial Communications Timeout		Event code	54010C0B hex ^{*1}	
Meaning	A timeout occurred in serial communications.				
Source	PLC Function Module		Source details	Instruction	Detection timing At instruction execution
Error attributes	Level	Observation	Recovery	---	Log category System
Effects	User program	Continues.	Operation	The relevant instruction will end according to specifications. The communications output will follow the specifications of the instruction.	
System-defined variables	Variable	Data type		Name	
	None	---		---	
Cause and correction	Assumed cause		Correction		Prevention
	Wiring to the remote device is not connected.		Check the wiring to the remote device and correct the wiring if there are any problems.		Confirm that wiring to the remote device is connected.
	Power to the remote device is OFF.		Turn ON the power to the remote device.		Confirm that the power to the remote device is turned ON.
	The communications settings or baud rate settings are not compatible with the remote device.		Make the communications settings and baud rate settings compatible with the remote device.		Make the communications settings and baud rate settings compatible with the remote device.
	Noise		Implement noise countermeasures.		Implement noise countermeasures.
Attached information	<p>Attached Information 1: Error Location</p> <p>Attached Information 2: Error Location Details (Rung Number). For a program section, the rung number from the start of the section is given. For ST, the line number is given.</p> <p>Attached Information 3: Names of the Instruction and Instruction Instance Where the Error Occurred. If there is more than one possible instruction, information is given on all of them. Nothing is given if the instruction cannot be identified.</p> <p>Attached information 4: Expansion Error Code (ErrorIDEx) is given for instructions that have Expansion Error Codes (ErrorIDEx). 0x00000000 is given for instructions that do not have Expansion Error Codes (ErrorIDEx).</p>				
Precautions/Remarks	If a program is changed after an error occurs, the attached information that is displayed may not be correct.				

*1. Error code 16#0C0B occurs for unit version 1.11 or later of the CPU Unit.

Event name	Instruction Executed to Inapplicable Port		Event code	54010C0C hex*1	
Meaning	An instruction was executed to an inapplicable port.				
Source	PLC Function Module		Source details	Instruction	Detection timing At instruction execution
Error attributes	Level	Observation	Recovery	---	Log category System
Effects	User program	Continues.	Operation	The relevant instruction will end according to specifications. The communications output will follow the specifications of the instruction.	
System-defined variables	Variable	Data type		Name	
	None	---		---	
Cause and correction	Assumed cause		Correction		Prevention
	An instruction was executed to an inapplicable port.		Specify a port that is applicable for the instruction, from the device port structure, and execute the instruction.		Specify a port that is applicable for the instruction, from the device port structure, and execute the instruction.
Attached information	<p>Attached Information 1: Error Location</p> <p>Attached Information 2: Error Location Details (Rung Number). For a program section, the rung number from the start of the section is given. For ST, the line number is given.</p> <p>Attached Information 3: Names of the Instruction and Instruction Instance Where the Error Occurred. If there is more than one possible instruction, information is given on all of them. Nothing is given if the instruction cannot be identified.</p> <p>Attached information 4: Expansion Error Code (ErrorIDEx) is given for instructions that have Expansion Error Codes (ErrorIDEx). 0x00000000 is given for instructions that do not have Expansion Error Codes (ErrorIDEx).</p>				
Precautions/Remarks	If a program is changed after an error occurs, the attached information that is displayed may not be correct.				

*1. Error code 16#0C0C occurs for unit version 1.11 or later of the CPU Unit.

Event name	CIF Unit Initialized		Event code	54010C0D hex*1	
Meaning	A CIF Unit was initialized, so the communications data buffered in the CIF Unit was lost.				
Source	PLC Function Module		Source details	Instruction	Detection timing At instruction execution
Error attributes	Level	Observation	Recovery	---	Log category System
Effects	User program	Continues.	Operation	The relevant instruction will end according to specifications. The communications output will follow the specifications of the instruction.	
System-defined variables	Variable	Data type		Name	
	None	---		---	
Cause and correction	Assumed cause		Correction		Prevention
	A CIF Unit was initialized.		Send or receive the data again, as required.		When a program that buffers communications data in a CIF Unit is executed, do not restart the CIF Unit.
Attached information	<p>Attached Information 1: Error Location</p> <p>Attached Information 2: Error Location Details (Rung Number). For a program section, the rung number from the start of the section is given. For ST, the line number is given.</p> <p>Attached Information 3: Names of the Instruction and Instruction Instance Where the Error Occurred. If there is more than one possible instruction, information is given on all of them. Nothing is given if the instruction cannot be identified.</p> <p>Attached information 4: Expansion Error Code (ErrorIDEx) is given for instructions that have Expansion Error Codes (ErrorIDEx). 0x00000000 is given for instructions that do not have Expansion Error Codes (ErrorIDEx).</p>				
Precautions/Remarks	If a program is changed after an error occurs, the attached information that is displayed may not be correct.				

*1. Error code 16#0C0D occurs for unit version 1.13 or later of the CPU Unit.

Event name	Exceptional Modbus Response		Event code	54010C10 hex*1	
Meaning	An exceptional code was returned from the Modbus slave.				
Source	PLC Function Module		Source details	Instruction	Detection timing At instruction execution
Error attributes	Level	Observation	Recovery	---	Log category System
Effects	User program	Continues.	Operation	The relevant instruction will end according to specifications. The communications output will follow the specifications of the instruction.	
System-defined variables	Variable	Data type		Name	
	None	---		---	
Cause and correction	Assumed cause		Correction		Prevention
	An error was detected on the Modbus slave.		Check the value xx in 16#0000_00xx of ErrorIDEx, identify error causes in the Modbus Protocol, and take required measures. Refer to the description for the relevant instruction for the reference to the Modbus Protocol.		Write the user program, including ones for remote devices, according to the Modbus Protocol.
Attached information	<p>Attached Information 1: Error Location</p> <p>Attached Information 2: Error Location Details (Rung Number). For a program section, the rung number from the start of the section is given. For ST, the line number is given.</p> <p>Attached Information 3: Names of the Instruction and Instruction Instance Where the Error Occurred. If there is more than one possible instruction, information is given on all of them. Nothing is given if the instruction cannot be identified.</p> <p>Attached Information 4: Expansion Error Code (<i>ErrorIDEx</i>)</p>				
Precautions/Remarks	If a program is changed after an error occurs, the attached information that is displayed may not be correct.				

*1. Error code 16#0C10 occurs for unit version 1.11 or later of the CPU Unit.

Event name	Invalid Modbus Response		Event code	54010C11 hex*1	
Meaning	An unexpected response was returned from the Modbus slave.				
Source	PLC Function Module		Source details	Instruction	Detection timing At instruction execution
Error attributes	Level	Observation	Recovery	---	Log category System
Effects	User program	Continues.	Operation	The relevant instruction will end according to specifications. The communications output will follow the specifications of the instruction.	
System-defined variables	Variable	Data type		Name	
	None	---		---	
Cause and correction	Assumed cause		Correction		Prevention
	The function code or data size of the response received from the Modbus slave was incorrect.		Review the transmission sequence with the remote devices, such as the send delay, reception monitoring time, and other options.		Write the user program so that the next command is not sent before a response is returned.
Attached information	<p>Attached Information 1: Error Location</p> <p>Attached Information 2: Error Location Details (Rung Number). For a program section, the rung number from the start of the section is given. For ST, the line number is given.</p> <p>Attached Information 3: Names of the Instruction and Instruction Instance Where the Error Occurred. If there is more than one possible instruction, information is given on all of them. Nothing is given if the instruction cannot be identified.</p> <p>Attached information 4: Expansion Error Code (ErrorIDEx) is given for instructions that have Expansion Error Codes (ErrorIDEx). 0x00000000 is given for instructions that do not have Expansion Error Codes (ErrorIDEx).</p>				
Precautions/Remarks	If a program is changed after an error occurs, the attached information that is displayed may not be correct.				

*1. Error code 16#0C11 occurs for unit version 1.11 or later of the CPU Unit.

Event name	SD Memory Card Access Failure			Event code	54011400 hex	
Meaning	SD Memory Card access failed when an instruction was executed.					
Source	PLC Function Module		Source details	Instruction	Detection timing	At instruction execution
Error attributes	Level	Observation	Recovery	---	Log category	System
Effects	User program	Continues.	Operation	The relevant instruction will end according to specifications. The operation of the Unit is not affected.		
System-defined variables	Variable	Data type		Name		
	None	---		---		
Cause and correction	Assumed cause		Correction		Prevention	
	An SD Memory Card is either not inserted or is not inserted properly.		Insert the SD Memory Card correctly.		Make sure that the SD Memory Card is inserted properly.	
	The SD Memory Card is broken.		Replace the SD Memory Card with one that operates normally.		None	
	The SD Memory Card slot is broken.		If this error persists even after making the above two corrections, replace the CPU Unit.		None	
Attached information	<p>Attached Information 1: Error Location</p> <p>Attached Information 2: Error Location Details (Rung Number). For a program section, the rung number from the start of the section is given. For ST, the line number is given.</p> <p>Attached Information 3: Names of the Instruction and Instruction Instance Where the Error Occurred. If there is more than one possible instruction, information is given on all of them. Nothing is given if the instruction cannot be identified.</p> <p>Attached information 4: Expansion Error Code (ErrorIDEx) is given for instructions that have Expansion Error Codes (ErrorIDEx). 0x00000000 is given for instructions that do not have Expansion Error Codes (ErrorIDEx).</p>					
Precautions/Remarks	If a program is changed after an error occurs, the attached information that is displayed may not be correct.					

Event name	SD Memory Card Write-protected			Event code	54011401 hex	
Meaning	An attempt was made to write to a write-protected SD Memory Card when an instruction was executed.					
Source	PLC Function Module		Source details	Instruction	Detection timing	At instruction execution
Error attributes	Level	Observation	Recovery	---	Log category	System
Effects	User program	Continues.	Operation	The relevant instruction will end according to specifications. The operation of the Unit is not affected.		
System-defined variables	Variable	Data type		Name		
	None	---		---		
Cause and correction	Assumed cause		Correction		Prevention	
	An attempt was made to write to a write-protected SD Memory Card.		Remove write protection from the SD Memory Card. Slide the small switch on the side of the SD Memory Card from the LOCK position to the writable position.		Use an SD Memory Card that is not write-protected when writing to the SD Memory Card.	
Attached information	<p>Attached Information 1: Error Location</p> <p>Attached Information 2: Error Location Details (Rung Number). For a program section, the rung number from the start of the section is given. For ST, the line number is given.</p> <p>Attached Information 3: Names of the Instruction and Instruction Instance Where the Error Occurred. If there is more than one possible instruction, information is given on all of them. Nothing is given if the instruction cannot be identified.</p> <p>Attached information 4: Expansion Error Code (ErrorIDEx) is given for instructions that have Expansion Error Codes (ErrorIDEx). 0x00000000 is given for instructions that do not have Expansion Error Codes (ErrorIDEx).</p>					
Precautions/Remarks	If a program is changed after an error occurs, the attached information that is displayed may not be correct.					

3 Error Descriptions and Corrections

Event name	SD Memory Card Insufficient Capacity			Event code	54011402 hex	
Meaning	The capacity of the SD Memory Card was insufficient when writing to the SD Memory Card for an instruction.					
Source	PLC Function Module		Source details	Instruction	Detection timing	At instruction execution
Error attributes	Level	Observation	Recovery	---	Log category	System
Effects	User program	Continues.	Operation	The relevant instruction will end according to specifications. The operation of the Unit is not affected.		
System-defined variables	Variable		Data type		Name	
	None		---		---	
Cause and correction	Assumed cause		Correction		Prevention	
	The SD Memory Card has run out of free space.		Replace the SD Memory Card for one with sufficient available space.		Use an SD Memory Card with sufficient available space when you add files to it.	
Attached information	<p>Attached Information 1: Error Location</p> <p>Attached Information 2: Error Location Details (Rung Number). For a program section, the rung number from the start of the section is given. For ST, the line number is given.</p> <p>Attached Information 3: Names of the Instruction and Instruction Instance Where the Error Occurred. If there is more than one possible instruction, information is given on all of them. Nothing is given if the instruction cannot be identified.</p> <p>Attached information 4: Expansion Error Code (ErrorIDEx) is given for instructions that have Expansion Error Codes (ErrorIDEx). 0x00000000 is given for instructions that do not have Expansion Error Codes (ErrorIDEx).</p>					
Precautions/Remarks	<ul style="list-style-type: none"> If a program is changed after an error occurs, the attached information that is displayed may not be correct. Do not remove the SD Memory Card during Card access. That may damage the SD Memory Card or corrupt the data on it. 					

Event name	File Does Not Exist			Event code	54011403 hex	
Meaning	The file specified for an instruction does not exist. Or, the specified file is corrupted.					
Source	PLC Function Module		Source details	Instruction	Detection timing	At instruction execution
Error attributes	Level	Observation	Recovery	---	Log category	System
Effects	User program	Continues.	Operation	The relevant instruction will end according to specifications. The operation of the Unit is not affected.		
System-defined variables	Variable		Data type		Name	
	None		---		---	
Cause and correction	Assumed cause		Correction		Prevention	
	The specified file does not exist.		Make sure that the filename that is specified for the instruction exists. Or, modify the filename so that it matches the filename specified for the instruction.		Make sure that the filename that is specified for the instruction exists.	
	The specified file is corrupted.		Specify the other filename.		None	
	The SD Memory Card cannot be normally accessed due to a contact failure or other causes.		Insert the SD Memory Card again or replace it.		None	
Attached information	<p>Attached Information 1: Error Location</p> <p>Attached Information 2: Error Location Details (Rung Number). For a program section, the rung number from the start of the section is given. For ST, the line number is given.</p> <p>Attached Information 3: Names of the Instruction and Instruction Instance Where the Error Occurred. If there is more than one possible instruction, information is given on all of them. Nothing is given if the instruction cannot be identified.</p> <p>Attached information 4: Expansion Error Code (ErrorIDEx) is given for instructions that have Expansion Error Codes (ErrorIDEx). 0x00000000 is given for instructions that do not have Expansion Error Codes (ErrorIDEx).</p>					
Precautions/Remarks	If a program is changed after an error occurs, the attached information that is displayed may not be correct.					

Event name	Too Many Files/Directories		Event code	54011404 hex	
Meaning	The maximum number of files/directories was exceeded when creating a file/directory for an instruction.				
Source	PLC Function Module		Source details	Instruction	Detection timing At instruction execution
Error attributes	Level	Observation	Recovery	---	Log category System
Effects	User program	Continues.	Operation	The relevant instruction will end according to specifications. The operation of the Unit is not affected.	
System-defined variables	Variable	Data type		Name	
	None	---		---	
Cause and correction	Assumed cause		Correction		Prevention
	The number of files or directories exceeded the maximum number.		Delete any unnecessary files and/or directories. Or, replace the SD Memory Card with one that has fewer files and directories compared to the maximum number of files and directories for FAT16 or FAT32.		Delete unnecessary files and directories so that there are not too many files and directories on the SD Memory Card. Regularly replace the SD Memory Card when the number of files grows constantly.
Attached information	<p>Attached Information 1: Error Location</p> <p>Attached Information 2: Error Location Details (Rung Number). For a program section, the rung number from the start of the section is given. For ST, the line number is given.</p> <p>Attached Information 3: Names of the Instruction and Instruction Instance Where the Error Occurred. If there is more than one possible instruction, information is given on all of them. Nothing is given if the instruction cannot be identified.</p> <p>Attached information 4: Expansion Error Code (ErrorIDEx) is given for instructions that have Expansion Error Codes (ErrorIDEx). 0x00000000 is given for instructions that do not have Expansion Error Codes (ErrorIDEx).</p>				
Precautions/Remarks	If a program is changed after an error occurs, the attached information that is displayed may not be correct.				

Event name	File Already in Use		Event code	54011405 hex		
Meaning	A file specified for an instruction cannot be accessed because it is already being used.					
Source	PLC Function Module		Source details	Instruction	Detection timing	At instruction execution
Error attributes	Level	Observation	Recovery	---	Log category	System
Effects	User program	Continues.	Operation	The relevant instruction will end according to specifications. The operation of the Unit is not affected.		
System-defined variables	Variable		Data type		Name	
	None		---		---	
Cause and correction	Assumed cause		Correction		Prevention	
	An instruction attempted to read or write a file already being accessed by another instruction.		Correct the program so that the relevant instruction is only executed when the <i>Busy</i> output variable for all other instructions for the same file are FALSE.		When you execute multiple instructions that access the same file, write the program so that the instructions are not executed simultaneously. Make sure that the <i>Busy</i> output variable for all other instructions for the same file is FALSE.	
Attached information	<p>Attached Information 1: Error Location</p> <p>Attached Information 2: Error Location Details (Rung Number). For a program section, the rung number from the start of the section is given. For ST, the line number is given.</p> <p>Attached Information 3: Names of the Instruction and Instruction Instance Where the Error Occurred. If there is more than one possible instruction, information is given on all of them. Nothing is given if the instruction cannot be identified.</p> <p>Attached information 4: Expansion Error Code (ErrorIDEx) is given for instructions that have Expansion Error Codes (ErrorIDEx). 0x00000000 is given for instructions that do not have Expansion Error Codes (ErrorIDEx).</p>					
Precautions/Remarks	If a program is changed after an error occurs, the attached information that is displayed may not be correct.					

Event name	Open Mode Mismatch		Event code	54011406 hex		
Meaning	A file operation for an instruction was inconsistent with the open mode of the file.					
Source	PLC Function Module		Source details	Instruction	Detection timing	At instruction execution
Error attributes	Level	Observation	Recovery	---	Log category	System
Effects	User program	Continues.	Operation	The relevant instruction will end according to specifications. The operation of the Unit is not affected.		
System-defined variables	Variable		Data type		Name	
	None		---		---	
Cause and correction	Assumed cause		Correction		Prevention	
	The file open mode specified by the Open File instruction does not match the file operation attempted by a subsequent SD Memory Card instruction.		Correct the Open File instruction to open the file in an open mode that is suitable for the file operation.		Change the Open File instruction to open the file in an open mode that is suitable for the file operation.	
Attached information	<p>Attached Information 1: Error Location</p> <p>Attached Information 2: Error Location Details (Rung Number). For a program section, the rung number from the start of the section is given. For ST, the line number is given.</p> <p>Attached Information 3: Names of the Instruction and Instruction Instance Where the Error Occurred. If there is more than one possible instruction, information is given on all of them. Nothing is given if the instruction cannot be identified.</p> <p>Attached information 4: Expansion Error Code (ErrorIDEx) is given for instructions that have Expansion Error Codes (ErrorIDEx). 0x00000000 is given for instructions that do not have Expansion Error Codes (ErrorIDEx).</p>					
Precautions/Remarks	If a program is changed after an error occurs, the attached information that is displayed may not be correct.					

Event name	Offset Out of Range			Event code	54011407 hex	
Meaning	Access to the address is not possible for the offset specified for an instruction.					
Source	PLC Function Module		Source details	Instruction	Detection timing	At instruction execution
Error attributes	Level	Observation	Recovery	---	Log category	System
Effects	User program	Continues.	Operation	The relevant instruction will end according to specifications. The operation of the Unit is not affected.		
System-defined variables	Variable	Data type		Name		
	None	---		---		
Cause and correction	Assumed cause		Correction		Prevention	
	An attempt was made to access beyond the size of the file.		Decrease the offset specified for the instruction.		Include information in the file so that the file format can be identified, and modify the program to check that information in order to perform appropriate file seeking.	
Attached information	<p>Attached Information 1: Error Location</p> <p>Attached Information 2: Error Location Details (Rung Number). For a program section, the rung number from the start of the section is given. For ST, the line number is given.</p> <p>Attached Information 3: Names of the Instruction and Instruction Instance Where the Error Occurred. If there is more than one possible instruction, information is given on all of them. Nothing is given if the instruction cannot be identified.</p> <p>Attached information 4: Expansion Error Code (ErrorIDEx) is given for instructions that have Expansion Error Codes (ErrorIDEx). 0x00000000 is given for instructions that do not have Expansion Error Codes (ErrorIDEx).</p>					
Precautions/Remarks	If a program is changed after an error occurs, the attached information that is displayed may not be correct.					

Event name	Directory Not Empty			Event code	54011408 hex	
Meaning	A directory was not empty when the Delete Directory instruction was executed or when an attempt was made to change the directory name.					
Source	PLC Function Module		Source details	Instruction	Detection timing	At instruction execution
Error attributes	Level	Observation	Recovery	---	Log category	System
Effects	User program	Continues.	Operation	The relevant instruction will end according to specifications. The operation of the Unit is not affected.		
System-defined variables	Variable	Data type		Name		
	None	---		---		
Cause and correction	Assumed cause		Correction		Prevention	
	A directory was not empty when the Delete Directory instruction was executed.		Delete all files in the relevant directory.		Check the contents of a directory before you delete the directory using the Delete Directory instruction or before you change the directory name.	
	A directory contained another directory when an attempt was made to change the directory name.		Delete all directories from the relevant directory.			
Attached information	<p>Attached Information 1: Error Location</p> <p>Attached Information 2: Error Location Details (Rung Number). For a program section, the rung number from the start of the section is given. For ST, the line number is given.</p> <p>Attached Information 3: Names of the Instruction and Instruction Instance Where the Error Occurred. If there is more than one possible instruction, information is given on all of them. Nothing is given if the instruction cannot be identified.</p> <p>Attached information 4: Expansion Error Code (ErrorIDEx) is given for instructions that have Expansion Error Codes (ErrorIDEx). 0x00000000 is given for instructions that do not have Expansion Error Codes (ErrorIDEx).</p>					
Precautions/Remarks	If a program is changed after an error occurs, the attached information that is displayed may not be correct.					

Event name	That File Name Already Exists			Event code	54011409 hex	
Meaning	An instruction could not be executed because the file name specified for the instruction already exists.					
Source	PLC Function Module		Source details	Instruction	Detection timing	At instruction execution
Error attributes	Level	Observation	Recovery	---	Log category	System
Effects	User program	Continues.	Operation	The relevant instruction will end according to specifications. The operation of the Unit is not affected.		
System-defined variables	Variable	None		Data type	---	
Cause and correction	Assumed cause		Correction		Prevention	
	A file already exists with the same name as the name specified for the instruction to create.		Correct the program so that the filename specified for the instruction does not already exist. Or, delete the existing file.		Make sure that the file specified does not already exist when you create a file with an instruction.	
Attached information	<p>Attached Information 1: Error Location</p> <p>Attached Information 2: Error Location Details (Rung Number). For a program section, the rung number from the start of the section is given. For ST, the line number is given.</p> <p>Attached Information 3: Names of the Instruction and Instruction Instance Where the Error Occurred. If there is more than one possible instruction, information is given on all of them. Nothing is given if the instruction cannot be identified.</p> <p>Attached information 4: Expansion Error Code (ErrorIDEx) is given for instructions that have Expansion Error Codes (ErrorIDEx). 0x00000000 is given for instructions that do not have Expansion Error Codes (ErrorIDEx).</p>					
Precautions/Remarks	<ul style="list-style-type: none"> If a program is changed after an error occurs, the attached information that is displayed may not be correct. When you delete an existing file, check to make sure that you no longer need the file. 					

Event name	Write Access Denied			Event code	5401140A hex	
Meaning	An attempt was made to write to a write-protected file or directory when an instruction was executed.					
Source	PLC Function Module		Source details	Instruction	Detection timing	At instruction execution
Error attributes	Level	Observation	Recovery	---	Log category	System
Effects	User program	Continues.	Operation	The relevant instruction will end according to specifications. The operation of the Unit is not affected.		
System-defined variables	Variable	None		Data type	---	
Cause and correction	Assumed cause		Correction		Prevention	
	The file or directory specified for the instruction to write is write-protected.		Remove write protection from the file or directory specified for the instruction. Or, change the filename of the file to write.		Do not write-protect any files that need to be written to.	
Attached information	<p>Attached Information 1: Error Location</p> <p>Attached Information 2: Error Location Details (Rung Number). For a program section, the rung number from the start of the section is given. For ST, the line number is given.</p> <p>Attached Information 3: Names of the Instruction and Instruction Instance Where the Error Occurred. If there is more than one possible instruction, information is given on all of them. Nothing is given if the instruction cannot be identified.</p> <p>Attached information 4: Expansion Error Code (ErrorIDEx) is given for instructions that have Expansion Error Codes (ErrorIDEx). 0x00000000 is given for instructions that do not have Expansion Error Codes (ErrorIDEx).</p>					
Precautions/Remarks	<ul style="list-style-type: none"> If a program is changed after an error occurs, the attached information that is displayed may not be correct. Before you remove write protection from a file, be sure it is OK to overwrite the file. 					

Event name	Too Many Files Open			Event code	5401140B hex	
Meaning	The maximum number of open files was exceeded when opening a file for an instruction.					
Source	PLC Function Module		Source details	Instruction	Detection timing	At instruction execution
Error attributes	Level	Observation	Recovery	---	Log category	System
Effects	User program	Continues.	Operation	The relevant instruction will end according to specifications. The operation of the Unit is not affected.		
System-defined variables	Variable	Data type		Name		
	None	---		---		
Cause and correction	Assumed cause		Correction		Prevention	
	The maximum number of open files was exceeded when opening a file for an instruction.		Correct the program to decrease the number of open files.		Decrease the number of files. Or, write the program so that files that no longer need to be open are closed in order to prevent too many files from being open at once.	
Attached information	<p>Attached Information 1: Error Location</p> <p>Attached Information 2: Error Location Details (Rung Number). For a program section, the rung number from the start of the section is given. For ST, the line number is given.</p> <p>Attached Information 3: Names of the Instruction and Instruction Instance Where the Error Occurred. If there is more than one possible instruction, information is given on all of them. Nothing is given if the instruction cannot be identified.</p> <p>Attached information 4: Expansion Error Code (ErrorIDEx) is given for instructions that have Expansion Error Codes (ErrorIDEx). 0x00000000 is given for instructions that do not have Expansion Error Codes (ErrorIDEx).</p>					
Precautions/Remarks	If a program is changed after an error occurs, the attached information that is displayed may not be correct.					

Event name	Directory Does Not Exist			Event code	5401140C hex	
Meaning	The directory specified for an instruction does not exist.					
Source	PLC Function Module		Source details	Instruction	Detection timing	At instruction execution
Error attributes	Level	Observation	Recovery	---	Log category	System
Effects	User program	Continues.	Operation	The relevant instruction will end according to specifications. The operation of the Unit is not affected.		
System-defined variables	Variable	Data type		Name		
	None	---		---		
Cause and correction	Assumed cause		Correction		Prevention	
	The directory specified for an instruction does not exist.		Correct the program so that the directory specified for the instruction exists. Or, create the relevant directory in advance.		Make sure that the directory specified for the instruction directory actually exists when using an instruction that accesses a directory.	
Attached information	<p>Attached Information 1: Error Location</p> <p>Attached Information 2: Error Location Details (Rung Number). For a program section, the rung number from the start of the section is given. For ST, the line number is given.</p> <p>Attached Information 3: Names of the Instruction and Instruction Instance Where the Error Occurred. If there is more than one possible instruction, information is given on all of them. Nothing is given if the instruction cannot be identified.</p> <p>Attached information 4: Expansion Error Code (ErrorIDEx) is given for instructions that have Expansion Error Codes (ErrorIDEx). 0x00000000 is given for instructions that do not have Expansion Error Codes (ErrorIDEx).</p>					
Precautions/Remarks	If a program is changed after an error occurs, the attached information that is displayed may not be correct.					

Event name	File or Directory Name Is Too Long		Event code	5401140D hex	
Meaning	The file name or directory name that was specified for an instruction is too long.				
Source	PLC Function Module		Source details	Instruction	Detection timing At instruction execution
Error attributes	Level	Observation	Recovery	---	Log category System
Effects	User program	Continues.	Operation	The relevant instruction will end according to specifications. The operation of the Unit is not affected.	
System-defined variables	Variable		Data type		Name
	None		---		---
Cause and correction	Assumed cause		Correction		Prevention
	The file name or directory name that was specified for the instruction to create is too long.		Correct the program so that the file name or directory name specified for the instruction is within FAT16 or FAT32 restrictions.		Write the program so that the specified file names and directory names are within FAT16 or FAT32 restrictions.
Attached information	<p>Attached Information 1: Error Location</p> <p>Attached Information 2: Error Location Details (Rung Number). For a program section, the rung number from the start of the section is given. For ST, the line number is given.</p> <p>Attached Information 3: Names of the Instruction and Instruction Instance Where the Error Occurred. If there is more than one possible instruction, information is given on all of them. Nothing is given if the instruction cannot be identified.</p> <p>Attached information 4: Expansion Error Code (ErrorIDEx) is given for instructions that have Expansion Error Codes (ErrorIDEx). 0x00000000 is given for instructions that do not have Expansion Error Codes (ErrorIDEx).</p>				
Precautions/Remarks	If a program is changed after an error occurs, the attached information that is displayed may not be correct.				

Event name	SD Memory Card Access Failed		Event code	5401140E hex	
Meaning	SD Memory Card access failed.				
Source	PLC Function Module		Source details	Instruction	Detection timing At instruction execution
Error attributes	Level	Observation	Recovery	---	Log category System
Effects	User program	Continues.	Operation	The relevant instruction will end according to specifications. The operation of the Unit is not affected.	
System-defined variables	Variable		Data type		Name
	None		---		---
Cause and correction	Assumed cause		Correction		Prevention
	The SD Memory Card is broken.		Replace the SD Memory Card.		None
	The SD Memory Card slot is broken.		If the error persists even after you make the above corrections, replace the CPU Unit.		None
Attached information	<p>Attached Information 1: Error Location</p> <p>Attached Information 2: Error Location Details (Rung Number). For a program section, the rung number from the start of the section is given. For ST, the line number is given.</p> <p>Attached Information 3: Names of the Instruction and Instruction Instance Where the Error Occurred. If there is more than one possible instruction, information is given on all of them. Nothing is given if the instruction cannot be identified.</p> <p>Attached information 4: Expansion Error Code (ErrorIDEx) is given for instructions that have Expansion Error Codes (ErrorIDEx). 0x00000000 is given for instructions that do not have Expansion Error Codes (ErrorIDEx).</p>				
Precautions/Remarks	If a program is changed after an error occurs, the attached information that is displayed may not be correct.				

Event name	Backup Operation Already in Progress		Event code	5401140F hex*1	
Meaning	Another backup operation is already in progress.				
Source	PLC Function Module		Source details	Instruction	Detection timing At instruction execution
Error attributes	Level	Observation	Recovery	---	Log category System
Effects	User program	Continues.	Operation	The relevant instruction will end according to specifications. The operation of the Unit is not affected.	
System-defined variables	Variable	Data type		Name	
	None	---		---	
Cause and correction	Assumed cause		Correction		Prevention
	Another backup operation is already in progress.		Wait for the backup operation to end and then execute the instruction again.		Do not attempt to execute other backup operation during a backup operation.
Attached information	<p>Attached Information 1: Error Location</p> <p>Attached Information 2: Error Location Details (Rung Number). For a program section, the rung number from the start of the section is given. For ST, the line number is given.</p> <p>Attached Information 3: Names of the Instruction and Instruction Instance Where the Error Occurred. If there is more than one possible instruction, information is given on all of them. Nothing is given if the instruction cannot be identified.</p> <p>Attached information 4: Expansion Error Code (ErrorIDEx) is given for instructions that have Expansion Error Codes (ErrorIDEx). 0x00000000 is given for instructions that do not have Expansion Error Codes (ErrorIDEx).</p>				
Precautions/Remarks	If a program is changed after an error occurs, the attached information that is displayed may not be correct.				

*1. Error code 16#140F occurs for unit version 1.08 or later of the CPU Unit.

Event name	Cannot Execute Backup		Event code	54011410 hex ^{*1}	
Meaning	Execution of a backup operation was not possible because execution of another operation was in progress.				
Source	PLC Function Module		Source details	Instruction	Detection timing At instruction execution
Error attributes	Level	Observation	Recovery	---	Log category System
Effects	User program	Continues.	Operation	The relevant instruction will end according to specifications. The operation of the Unit is not affected.	
System-defined variables	Variable	Data type		Name	
	None	---		---	
Cause and correction	Assumed cause		Correction		Prevention
	Execution of the instruction was attempted during execution of online editing.		Complete online editing and then execute the instruction again.		Do not attempt to execute a backup operation during execution of online editing.
	Execution of the instruction was attempted during execution of a Save Cam Table instruction.		Complete the Save Cam Table instruction and then execute the instruction again.		Do not attempt to execute a backup operation during execution of a Save Cam Table instruction.
	Execution of the instruction was attempted while a CPU Unit name change operation was in progress.		Complete the CPU Unit name change and then execute the instruction again.		Do not attempt to execute a backup operation during execution of a CPU Unit name change.
Attached information	<p>Attached Information 1: Error Location</p> <p>Attached Information 2: Error Location Details (Rung Number). For a program section, the rung number from the start of the section is given. For ST, the line number is given.</p> <p>Attached Information 3: Names of the Instruction and Instruction Instance Where the Error Occurred. If there is more than one possible instruction, information is given on all of them. Nothing is given if the instruction cannot be identified.</p> <p>Attached information 4: Expansion Error Code (ErrorIDEx) is given for instructions that have Expansion Error Codes (ErrorIDEx). 0x00000000 is given for instructions that do not have Expansion Error Codes (ErrorIDEx).</p>				
Precautions/Remarks	If a program is changed after an error occurs, the attached information that is displayed may not be correct.				

*1. Error code 16#1410 occurs for unit version 1.08 or later of the CPU Unit.

Event name	Unit/Slave Backup Failed		Event code	54011411 hex*1	
Meaning	A Unit/slave backup operation failed.				
Source	PLC Function Module		Source details	Instruction	Detection timing At instruction execution
Error attributes	Level	Observation	Recovery	---	Log category System
Effects	User program	Continues.	Operation	The relevant instruction will end according to specifications. The operation of the Unit is not affected.	
System-defined variables	Variable	Data type		Name	
	None	---		---	
Cause and correction	Assumed cause		Correction		Prevention
	A Unit/slave backup operation failed.		Refer to the corrections for the following events: CJ-series Unit Backup Failed (102D0000 hex) or EtherCAT Slave Backup Failed (102F0000 hex).		Refer to the preventive measures for the following events: CJ-series Unit Backup Failed (102D0000 hex) or EtherCAT Slave Backup Failed (102F0000 hex).
Attached information	<p>Attached Information 1: Error Location</p> <p>Attached Information 2: Error Location Details (Rung Number). For a program section, the rung number from the start of the section is given. For ST, the line number is given.</p> <p>Attached Information 3: Names of the Instruction and Instruction Instance Where the Error Occurred. If there is more than one possible instruction, information is given on all of them. Nothing is given if the instruction cannot be identified.</p> <p>Attached information 4: Expansion Error Code (ErrorIDEx) is given for instructions that have Expansion Error Codes (ErrorIDEx). 0x00000000 is given for instructions that do not have Expansion Error Codes (ErrorIDEx).</p>				
Precautions/Remarks	If a program is changed after an error occurs, the attached information that is displayed may not be correct.				

*1. Error code 16#1411 occurs for unit version 1.08 or later of the CPU Unit.

Event name	EtherCAT Communications Error		Event code	54011800 hex	
Meaning	Accessing the EtherCAT network failed when an instruction was executed.				
Source	PLC Function Module		Source details	Instruction	Detection timing At instruction execution
Error attributes	Level	Observation	Recovery	---	Log category System
Effects	User program	Continues.	Operation	The relevant instruction will end according to specifications.	
System-defined variables	Variable	Data type		Name	
	None	---		---	
Cause and correction	Assumed cause		Correction		Prevention
	The EtherCAT network is not in a usable status.		Check the operation status of the EtherCAT network by checking the status of the EtherCAT master. Use this information to correct the cause of the problem.		Depends on the nature of the error.
Attached information	<p>Attached Information 1: Error Location</p> <p>Attached Information 2: Error Location Details (Rung Number). For a program section, the rung number from the start of the section is given. For ST, the line number is given.</p> <p>Attached Information 3: Names of the Instruction and Instruction Instance Where the Error Occurred. If there is more than one possible instruction, information is given on all of them. Nothing is given if the instruction cannot be identified.</p> <p>Attached information 4: Expansion Error Code (ErrorIDEx) is given for instructions that have Expansion Error Codes (ErrorIDEx). 0x00000000 is given for instructions that do not have Expansion Error Codes (ErrorIDEx).</p>				
Precautions/Remarks	If a program is changed after an error occurs, the attached information that is displayed may not be correct.				

Event name	EtherCAT Slave Does Not Respond			Event code	54011801 hex	
Meaning	Accessing the target slave failed when an instruction was executed.					
Source	PLC Function Module		Source details	Instruction	Detection timing	At instruction execution
Error attributes	Level	Observation	Recovery	---	Log category	System
Effects	User program	Continues.	Operation	The relevant instruction will end according to specifications.		
System-defined variables	Variable	Data type		Name		
	None	---		---		
Cause and correction	Assumed cause		Correction		Prevention	
	The target slave does not exist.		Specify an existing node address.		Specify an existing node address for the target slave.	
	The target slave is not in an operating condition.		Check the status of the target EtherCAT slave. Make sure that the target slave is in a usable status.		Make sure that the target slave is in a usable status.	
Attached information	<p>Attached Information 1: Error Location</p> <p>Attached Information 2: Error Location Details (Rung Number). For a program section, the rung number from the start of the section is given. For ST, the line number is given.</p> <p>Attached Information 3: Names of the Instruction and Instruction Instance Where the Error Occurred. If there is more than one possible instruction, information is given on all of them. Nothing is given if the instruction cannot be identified.</p> <p>Attached information 4: Expansion Error Code (ErrorIDEx) is given for instructions that have Expansion Error Codes (ErrorIDEx). 0x00000000 is given for instructions that do not have Expansion Error Codes (ErrorIDEx).</p>					
Precautions/Remarks	If a program is changed after an error occurs, the attached information that is displayed may not be correct.					

Event name	EtherCAT Timeout			Event code	54011802 hex	
Meaning	A timeout occurred while trying to access an EtherCAT slave when an instruction was executed.					
Source	PLC Function Module		Source details	Instruction	Detection timing	At instruction execution
Error attributes	Level	Observation	Recovery	---	Log category	System
Effects	User program	Continues.	Operation	The relevant instruction will end according to specifications.		
System-defined variables	Variable	Data type		Name		
	None	---		---		
Cause and correction	Assumed cause		Correction		Prevention	
	Communications with the target slave timed out.		Check the operating status of the target slave and correct the cause of the problem.		Depends on the nature of the error.	
Attached information	<p>Attached Information 1: Error Location</p> <p>Attached Information 2: Error Location Details (Rung Number). For a program section, the rung number from the start of the section is given. For ST, the line number is given.</p> <p>Attached Information 3: Names of the Instruction and Instruction Instance Where the Error Occurred. If there is more than one possible instruction, information is given on all of them. Nothing is given if the instruction cannot be identified.</p> <p>Attached information 4: Expansion Error Code (ErrorIDEx) is given for instructions that have Expansion Error Codes (ErrorIDEx). 0x00000000 is given for instructions that do not have Expansion Error Codes (ErrorIDEx).</p>					
Precautions/Remarks	If a program is changed after an error occurs, the attached information that is displayed may not be correct.					

Event name	Reception Buffer Overflow			Event code	54011803 hex	
Meaning	The receive data from an EtherCAT slave overflowed the receive buffer when an instruction was executed.					
Source	PLC Function Module		Source details	Instruction	Detection timing	At instruction execution
Error attributes	Level	Observation	Recovery	---	Log category	System
Effects	User program	Continues.	Operation	The relevant instruction will end according to specifications. It will not be possible to receive data from the slave.		
System-defined variables	Variable	Data type		Name		
	None	---		---		
Cause and correction	Assumed cause		Correction		Prevention	
	The receive data from the slave overflowed the receive buffer.		Set the size of the reception buffer to a value larger than the size of the receive data from the slave.		Set the size of the receive buffer to a value larger than the size of the receive data from the slave.	
Attached information	<p>Attached Information 1: Error Location</p> <p>Attached Information 2: Error Location Details (Rung Number). For a program section, the rung number from the start of the section is given. For ST, the line number is given.</p> <p>Attached Information 3: Names of the Instruction and Instruction Instance Where the Error Occurred. If there is more than one possible instruction, information is given on all of them. Nothing is given if the instruction cannot be identified.</p> <p>Attached information 4: Expansion Error Code (ErrorIDEx) is given for instructions that have Expansion Error Codes (ErrorIDEx). 0x00000000 is given for instructions that do not have Expansion Error Codes (ErrorIDEx).</p>					
Precautions/Remarks	If a program is changed after an error occurs, the attached information that is displayed may not be correct.					

Event name	SDO Abort Error			Event code	54011804 hex	
Meaning	An SDO abort error was received from an EtherCAT slave when an instruction was executed.					
Source	PLC Function Module		Source details	Instruction	Detection timing	At instruction execution
Error attributes	Level	Observation	Recovery	---	Log category	System
Effects	User program	Continues.	Operation	The relevant instruction will end according to specifications.		
System-defined variables	Variable	Data type		Name		
	None	---		---		
Cause and correction	Assumed cause		Correction		Prevention	
	Depends on the specifications of the slave.		Refer to the manual for the slave and correct the problem.		Refer to the manual for the slave and take the necessary steps to prevent the problem.	
Attached information	<p>Attached Information 1: Error Location</p> <p>Attached Information 2: Error Location Details (Rung Number). For a program section, the rung number from the start of the section is given. For ST, the line number is given.</p> <p>Attached Information 3: Names of the Instruction and Instruction Instance Where the Error Occurred. If there is more than one possible instruction, information is given on all of them. Nothing is given if the instruction cannot be identified.</p> <p>Attached information 4: Expansion Error Code (ErrorIDEx) is given for instructions that have Expansion Error Codes (ErrorIDEx). 0x00000000 is given for instructions that do not have Expansion Error Codes (ErrorIDEx).</p>					
Precautions/Remarks	If a program is changed after an error occurs, the attached information that is displayed may not be correct.					

Event name	Saving Packet Monitor File			Event code	54011805 hex	
Meaning	An instruction for packet monitoring was executed while saving an EtherCAT packet monitor file.					
Source	PLC Function Module		Source details	Instruction	Detection timing	At instruction execution
Error attributes	Level	Observation	Recovery	---	Log category	System
Effects	User program	Continues.	Operation	The relevant instruction will end according to specifications.		
System-defined variables	Variable	None		Data type	---	
Cause and correction	Assumed cause		Correction		Prevention	
	An instruction for packet monitoring was executed while saving an EtherCAT packet monitor file.		Execute the instruction for packet monitoring after saving the EtherCAT packet monitor file is completed. You can check packet monitor file save status to see if saving a packet monitor file is completed.		Execute packet monitoring instructions only after the packet monitor file is saved. You can check packet monitor file save status to see if saving a packet monitor file is completed.	
Attached information	<p>Attached Information 1: Error Location</p> <p>Attached Information 2: Error Location Details (Rung Number). For a program section, the rung number from the start of the section is given. For ST, the line number is given.</p> <p>Attached Information 3: Names of the Instruction and Instruction Instance Where the Error Occurred. If there is more than one possible instruction, information is given on all of them. Nothing is given if the instruction cannot be identified.</p> <p>Attached information 4: Expansion Error Code (ErrorIDEx) is given for instructions that have Expansion Error Codes (ErrorIDEx). 0x00000000 is given for instructions that do not have Expansion Error Codes (ErrorIDEx).</p>					
Precautions/Remarks	If a program is changed after an error occurs, the attached information that is displayed may not be correct.					

Event name	Packet Monitoring Function Not Started			Event code	54011806 hex	
Meaning	A Stop EtherCAT Packet Monitor instruction was executed when EtherCAT packet monitoring was stopped.					
Source	PLC Function Module		Source details	Instruction	Detection timing	At instruction execution
Error attributes	Level	Observation	Recovery	---	Log category	System
Effects	User program	Continues.	Operation	The relevant instruction will end according to specifications.		
System-defined variables	Variable	None		Data type	---	
Cause and correction	Assumed cause		Correction		Prevention	
	A Stop EtherCAT Packet Monitor instruction was executed when EtherCAT packet monitoring was stopped.		Execute the Stop EtherCAT Packet Monitor instruction after starting the packet monitoring function. You can check packet monitoring function operation status to see if the packet monitoring function is currently in operation.		Execute the Stop EtherCAT Packet Monitor instruction after starting the packet monitoring function. You can check packet monitoring function operation status to see if the packet monitoring function is currently in operation.	
Attached information	<p>Attached Information 1: Error Location</p> <p>Attached Information 2: Error Location Details (Rung Number). For a program section, the rung number from the start of the section is given. For ST, the line number is given.</p> <p>Attached Information 3: Names of the Instruction and Instruction Instance Where the Error Occurred. If there is more than one possible instruction, information is given on all of them. Nothing is given if the instruction cannot be identified.</p> <p>Attached information 4: Expansion Error Code (ErrorIDEx) is given for instructions that have Expansion Error Codes (ErrorIDEx). 0x00000000 is given for instructions that do not have Expansion Error Codes (ErrorIDEx).</p>					
Precautions/Remarks	If a program is changed after an error occurs, the attached information that is displayed may not be correct.					

Event name	Packet Monitoring Function in Operation		Event code	54011807 hex	
Meaning	A Start EtherCAT Packet Monitor instruction was executed when EtherCAT packet monitoring was already being executed.				
Source	PLC Function Module		Source details	Instruction	Detection timing At instruction execution
Error attributes	Level	Observation	Recovery	---	Log category System
Effects	User program	Continues.	Operation	The relevant instruction will end according to specifications.	
System-defined variables	Variable	Data type		Name	
	None	---		---	
Cause and correction	Assumed cause		Correction		Prevention
	The Start EtherCAT Packet Monitor instruction was executed again while the EtherCAT packet monitoring function was already in operation.		Execute the Start EtherCAT Packet Monitor instruction after the packet monitoring function was stopped. You can check packet monitoring function operation status to see if the packet monitoring function is stopped.		Execute the Start EtherCAT Packet Monitor instruction after the packet monitoring function is stopped. You can check packet monitoring function operation status to see if the packet monitoring function is stopped.
Attached information	<p>Attached Information 1: Error Location</p> <p>Attached Information 2: Error Location Details (Rung Number). For a program section, the rung number from the start of the section is given. For ST, the line number is given.</p> <p>Attached Information 3: Names of the Instruction and Instruction Instance Where the Error Occurred. If there is more than one possible instruction, information is given on all of them. Nothing is given if the instruction cannot be identified.</p> <p>Attached information 4: Expansion Error Code (ErrorIDEx) is given for instructions that have Expansion Error Codes (ErrorIDEx). 0x00000000 is given for instructions that do not have Expansion Error Codes (ErrorIDEx).</p>				
Precautions/Remarks	If a program is changed after an error occurs, the attached information that is displayed may not be correct.				

Event name	Communications Resource Overflow		Event code	54011808 hex	
Meaning	More than 32 EtherCAT communications instructions/IO-Link communications instructions were executed at the same time.				
Source	PLC Function Module		Source details	Instruction	Detection timing At instruction execution
Error attributes	Level	Observation	Recovery	---	Log category System
Effects	User program	Continues.	Operation	The relevant instruction will end according to specifications.	
System-defined variables	Variable	Data type		Name	
	None	---		---	
Cause and correction	Assumed cause	Correction		Prevention	
	<p>More than 32 EtherCAT communications instructions/IO-Link communications instructions were executed at the same time. The EtherCAT communications instructions/IO-Link communications instructions are listed below.</p> <ul style="list-style-type: none"> • EC_CoESDOWrite instruction • EC_CoESDORead instruction • EC_ConnectSlave instruction • EC_DisconnectSlave instruction • EC_ChangeEnableSetting instruction • EC_StartMon instruction • EC_SaveMon instruction • EC_StopMon instruction • EC_CopyMon instruction • IOL_ReadObj instruction • IOL_WriteObj instruction • EC_GetMasterStatistics instruction • EC_ClearMasterStatistics instruction • EC_GetSlaveStatistics instruction • EC_ClearSlaveStatistics instruction 	Correct the program so that no more than 32 EtherCAT communications instructions/IO-Link communications instructions are executed at the same time.		Write the program so that no more than 32 EtherCAT communications instructions/IO-Link communications instructions are executed at the same time.	
Attached information	<p>Attached Information 1: Error Location</p> <p>Attached Information 2: Error Location Details (Rung Number). For a program section, the rung number from the start of the section is given. For ST, the line number is given.</p> <p>Attached Information 3: Names of the Instruction and Instruction Instance Where the Error Occurred. If there is more than one possible instruction, information is given on all of them. Nothing is given if the instruction cannot be identified.</p> <p>Attached information 4: Expansion Error Code (ErrorIDEx) is given for instructions that have Expansion Error Codes (ErrorIDEx). 0x00000000 is given for instructions that do not have Expansion Error Codes (ErrorIDEx).</p>				
Precautions/Remarks	If a program is changed after an error occurs, the attached information that is displayed may not be correct.				

Event name	Packet Monitoring Function Not Supported		Event code	54011809 hex*1	
Meaning	Packets cannot be monitored.				
Source	PLC Function Module		Source details	Instruction	Detection timing At instruction execution
Error attributes	Level	Observation	Recovery	---	Log category System
Effects	User program	Continues.	Operation	The relevant instruction will end according to specifications.	
System-defined variables	Variable	Data type		Name	
	None	---		---	
Cause and correction	Assumed cause		Correction		Prevention
	An instruction for packet monitoring was executed for a CPU Unit that does not support packet monitoring.		Do not execute the EC_StartMon, EC_SaveMon, EC_StopMon, or EC_CopyMon instruction. If packet monitoring is required, use a CPU Unit that supports packet monitoring.		Do not execute instructions for packet monitoring for a CPU Unit that does not support packet monitoring.
Attached information	<p>Attached Information 1: Error Location</p> <p>Attached Information 2: Error Location Details (Rung Number). For a program section, the rung number from the start of the section is given. For ST, the line number is given.</p> <p>Attached Information 3: Names of the Instruction and Instruction Instance Where the Error Occurred. If there is more than one possible instruction, information is given on all of them. Nothing is given if the instruction cannot be identified.</p> <p>Attached information 4: Expansion Error Code (ErrorIDEx) is given for instructions that have Expansion Error Codes (ErrorIDEx). 0x00000000 is given for instructions that do not have Expansion Error Codes (ErrorIDEx).</p>				
Precautions/Remarks	If a program is changed after an error occurs, the attached information that is displayed may not be correct.				

*1. Error code 16#1809 occurs for unit version 1.01 or later of the CPU Unit.

Event name	Cannot Execute Instruction to Slave		Event code	5401180A hex*1	
Meaning	An instruction was executed for a slave that cannot execute an instruction.				
Source	PLC Function Module		Source details	Instruction	Detection timing At instruction execution
Error attributes	Level	Observation	Recovery	---	Log category System
Effects	User program	Continues.	Operation	The relevant instruction will end according to specifications.	
System-defined variables	Variable	Data type		Name	
	None	---		---	
Cause and correction	Assumed cause		Correction		Prevention
	The EC_DisconnectSlave or EC_ConnectSlave instruction was executed for a disabled slave.		Correct the program so that the EC_DisconnectSlave and EC_ConnectSlave instructions are not executed for the disabled slave.		Write the program so that the EC_DisconnectSlave and EC_ConnectSlave instructions are not executed for the disabled slave.
	The EC_ChangeEnableSetting instruction was executed for a disconnected slave.		Correct the program so that the EC_ChangeEnableSetting instruction is not executed for the disconnected slave.		Write the program so that the EC_ChangeEnableSetting instruction is not executed for the disconnected slave.
	The EC_DisconnectSlave or EC_ChangeEnableSetting instruction was executed for a slave in the ring topology.		Correct the program so that the EC_DisconnectSlave and EC_ChangeEnableSetting instructions are not executed for slaves in the ring topology.		Write the program so that the EC_DisconnectSlave and EC_ChangeEnableSetting instructions are not executed for slaves in the ring topology.
Attached information	<p>Attached information 1: Error Location</p> <p>Attached information 2: Error Location Details (Rung Number). For a program section, the rung number from the start of the section is given. For ST, the line number is given.</p> <p>Attached information 3: Names of the Instruction and Instruction Instance Where the Error Occurred. If there is more than one possible instruction, information is given on all of them. Nothing is given if the instruction cannot be identified.</p> <p>Attached information 4: Expansion Error Code (ErrorIDEx) is given for instructions that have Expansion Error Codes (ErrorIDEx). 0x00000000 is given for instructions that do not have Expansion Error Codes (ErrorIDEx).</p>				
Precautions/Remarks	If a program is changed after an error occurs, the attached information that is displayed may not be correct.				

*1. Error code 16#180A occurs for unit version 1.40 or later of the CPU Unit.

Event name	Diagnosis/Statistics Log Executing		Event code	5401180D hex*1	
Meaning	A master/slave diagnostic and statistical information instruction cannot be executed because the diagnosis/statistics log is in operation.				
Source	PLC Function Module		Source details	Instruction	Detection timing At instruction execution
Error attributes	Level	Observation	Recovery	---	Log category System
Effects	User program	Continues.	Operation	The relevant instruction will end according to specifications.	
System-defined variables	Variable	Data type		Name	
	_EC_StatisticsLogBusy	BOOL		Diagnosis/Statistics Log Busy	
Cause and correction	Assumed cause		Correction		Prevention
	A master diagnostic and statistical information instruction (EC_GetMasterStatistics or EC_ClearMasterStatistics), or a slave diagnostic and statistical information instruction (EC_GetSlaveStatistics or EC_ClearSlaveStatistics) was executed while the diagnosis/statistics log was in operation.		Correct the program so that a master diagnostic and statistical information instruction or a slave diagnostic and statistical information instruction is not executed during execution of the diagnosis/statistics log.		Write the program so that a master diagnostic and statistical information instruction or a slave diagnostic and statistical information instruction is executed when the value of the <i>_EC_StatisticsLogBusy</i> system-defined variable is FALSE.
Attached information	<p>Attached information 1: Error Location</p> <p>Attached information 2: Error Location Details (Rung Number). For a program section, the rung number from the start of the section is given. For ST, the line number is given.</p> <p>Attached information 3: Names of the Instruction and Instruction Instance Where the Error Occurred. If there is more than one possible instruction, information is given on all of them. Nothing is given if the instruction cannot be identified.</p> <p>Attached information 4: Expansion Error Code (ErrorIDEx) is given for instructions that have Expansion Error Codes (ErrorIDEx). 0x00000000 is given for instructions that do not have Expansion Error Codes (ErrorIDEx).</p>				
Precautions/Remarks	If a program is changed after an error occurs, the attached information that is displayed may not be correct.				

*1. This event code occurs for a CPU Unit with unit version 1.64 or later and project unit version 1.64 or later.

Event name	Master Diagnostic and Statistical Information Instruction Multi-execution Disabled		Event code	5401180E hex*1		
Meaning	A master diagnostic and statistical information instruction cannot be executed because more than one master diagnostic and statistical information instruction was executed simultaneously.					
Source	PLC Function Module		Source details	Instruction	Detection timing	At instruction execution
Error attributes	Level	Observation	Recovery	---	Log category	System
Effects	User program	Continues.	Operation	The relevant instruction will end according to specifications.		
System-defined variables	Variable		Data type		Name	
	None		---		---	
Cause and correction	Assumed cause		Correction		Prevention	
	A master diagnostic and statistical information instruction was executed during execution of the master diagnostic and statistical information instruction (EC_GetMasterStatistics or EC_ClearMasterStatistics).		Correct the program so that a master diagnostic and statistical information instruction is not executed during execution of the master diagnostic and statistical information instruction.		Write the program so that a master diagnostic and statistical information instruction is not executed during execution of the master diagnostic and statistical information instruction.	
Attached information	<p>Attached information 1: Error Location</p> <p>Attached information 2: Error Location Details (Rung Number). For a program section, the rung number from the start of the section is given. For ST, the line number is given.</p> <p>Attached information 3: Names of the Instruction and Instruction Instance Where the Error Occurred. If there is more than one possible instruction, information is given on all of them. Nothing is given if the instruction cannot be identified.</p> <p>Attached information 4: Expansion Error Code (ErrorIDEx) is given for instructions that have Expansion Error Codes (ErrorIDEx). 0x00000000 is given for instructions that do not have Expansion Error Codes (ErrorIDEx).</p>					
Precautions/Remarks	If a program is changed after an error occurs, the attached information that is displayed may not be correct.					

*1. This event code occurs for a CPU Unit with unit version 1.64 or later and project unit version 1.64 or later.

Event name	Slave Diagnostic and Statistical Information Instruction Multi-execution Disabled		Event code	5401180F hex*1		
Meaning	A slave diagnostic and statistical information instruction cannot be executed because more than one slave diagnostic and statistical information instruction was executed simultaneously.					
Source	PLC Function Module		Source details	Instruction	Detection timing	At instruction execution
Error attributes	Level	Observation	Recovery	---	Log category	System
Effects	User program	Continues.	Operation	The relevant instruction will end according to specifications.		
System-defined variables	Variable	Data type		Name		
	None	---		---		
Cause and correction	Assumed cause		Correction		Prevention	
	A slave diagnostic and statistical information instruction was executed during execution of the slave diagnostic and statistical information instruction (EC_GetSlaveStatistics or EC_ClearSlaveStatistics).		Correct the program so that a slave diagnostic and statistical information instruction is not executed during execution of the slave diagnostic and statistical information instruction.		Write the program so that a slave diagnostic and statistical information instruction is not executed during execution of the slave diagnostic and statistical information instruction.	
Attached information	Attached information 1: Error Location Attached information 2: Error Location Details (Rung Number). For a program section, the rung number from the start of the section is given. For ST, the line number is given. Attached information 3: Names of the Instruction and Instruction Instance Where the Error Occurred. If there is more than one possible instruction, information is given on all of them. Nothing is given if the instruction cannot be identified. Attached information 4: Expansion Error Code (ErrorIDEx) is given for instructions that have Expansion Error Codes (ErrorIDEx). 0x00000000 is given for instructions that do not have Expansion Error Codes (ErrorIDEx).					
Precautions/Remarks	If a program is changed after an error occurs, the attached information that is displayed may not be correct.					

*1. This event code occurs for a CPU Unit with unit version 1.64 or later and project unit version 1.64 or later.

Event name	Explicit Message Error		Event code	54011C00 hex		
Meaning	An error response code was returned for an explicit message that was sent with a CIP communications instruction.					
Source	PLC Function Module		Source details	Instruction	Detection timing	At instruction execution
Error attributes	Level	Observation	Recovery	---	Log category	System
Effects	User program	Continues.	Operation	The relevant instruction will end according to specifications.		
System-defined variables	Variable	Data type		Name		
	None	---		---		
Cause and correction	Assumed cause		Correction		Prevention	
	Depends on the nature of the error.		Check the value of the <i>ErrorIDEx</i> output variable from the instruction and refer to the description in this manual of the CIP message error code.		Depends on the nature of the error. Refer to the description in this manual of the CIP message error code.	
Attached information	<p>Attached Information 1: Error Location</p> <p>Attached Information 2: Error Location Details (Rung Number). For a program section, the rung number from the start of the section is given. For ST, the line number is given.</p> <p>Attached Information 3: Names of the Instruction and Instruction Instance Where the Error Occurred. If there is more than one possible instruction, information is given on all of them. Nothing is given if the instruction cannot be identified.</p> <p>Attached information 4: Expansion Error Code (ErrorIDEx) is given for instructions that have Expansion Error Codes (ErrorIDEx). 0x00000000 is given for instructions that do not have Expansion Error Codes (ErrorIDEx).</p>					
Precautions/Remarks	If a program is changed after an error occurs, the attached information that is displayed may not be correct.					

Event name	Incorrect Route Path		Event code	54011C01 hex		
Meaning	The format of the route path that is specified for a CIP communications instruction is not correct.					
Source	PLC Function Module		Source details	Instruction	Detection timing	At instruction execution
Error attributes	Level	Observation	Recovery	---	Log category	System
Effects	User program	Continues.	Operation	The relevant instruction will end according to specifications.		
System-defined variables	Variable	Data type		Name		
	None	---		---		
Cause and correction	Assumed cause		Correction		Prevention	
	The format of the route path that is specified for a CIP communications instruction is not correct.		Correct the route path that is specified by the instruction.		Make sure that the instructions specify correct route paths.	
	Address resolution failed for the host name that was specified in a CIP communications instruction.		Refer to the corrections for the following event: Address Resolution Failed (54012002 hex).		Refer to the preventive information for the following event: Address Resolution Failed (54012002 hex).	
Attached information	<p>Attached Information 1: Error Location</p> <p>Attached Information 2: Error Location Details (Rung Number). For a program section, the rung number from the start of the section is given. For ST, the line number is given.</p> <p>Attached Information 3: Names of the Instruction and Instruction Instance Where the Error Occurred. If there is more than one possible instruction, information is given on all of them. Nothing is given if the instruction cannot be identified.</p> <p>Attached information 4: Expansion Error Code (ErrorIDEx) is given for instructions that have Expansion Error Codes (ErrorIDEx). 0x00000000 is given for instructions that do not have Expansion Error Codes (ErrorIDEx).</p>					
Precautions/Remarks	If a program is changed after an error occurs, the attached information that is displayed may not be correct.					

Event name	CIP Handle Out of Range		Event code	54011C02 hex	
Meaning	The handle that is specified for the CIP communications instruction is not correct.				
Source	PLC Function Module		Source details	Instruction	Detection timing At instruction execution
Error attributes	Level	Observation	Recovery	---	Log category System
Effects	User program	Continues.	Operation	The relevant instruction will end according to specifications.	
System-defined variables	Variable	Data type		Name	
	None	---		---	
Cause and correction	Assumed cause		Correction		Prevention
	The handle that is specified for the CIP communications instruction is not correct.		Correct the handle for the instruction to the handle that was obtained with the CIPOpen instruction.		Specify handles that were obtained with the CIPOpen instruction.
Attached information	<p>Attached Information 1: Error Location</p> <p>Attached Information 2: Error Location Details (Rung Number). For a program section, the rung number from the start of the section is given. For ST, the line number is given.</p> <p>Attached Information 3: Names of the Instruction and Instruction Instance Where the Error Occurred. If there is more than one possible instruction, information is given on all of them. Nothing is given if the instruction cannot be identified.</p> <p>Attached information 4: Expansion Error Code (ErrorIDEx) is given for instructions that have Expansion Error Codes (ErrorIDEx). 0x00000000 is given for instructions that do not have Expansion Error Codes (ErrorIDEx).</p>				
Precautions/Remarks	If a program is changed after an error occurs, the attached information that is displayed may not be correct.				

Event name	CIP Communications Resource Overflow		Event code	54011C03 hex	
Meaning	The maximum resources that you can use for CIP communications instructions at the same time was exceeded.				
Source	PLC Function Module		Source details	Instruction	Detection timing At instruction execution
Error attributes	Level	Observation	Recovery	---	Log category System
Effects	User program	Continues.	Operation	The relevant instruction will end according to specifications.	
System-defined variables	Variable	Data type		Name	
	None	---		---	
Cause and correction	Assumed cause		Correction		Prevention
	More than 32 CIP communications instructions were executed at the same time.		Correct the user program so that no more than 32 CIP communications instructions are executed at the same time.		Write the user program so that no more than 32 CIP communications instructions are executed at the same time.
	An attempt was made to use more than 32 handles at the same time.		Correct the user program so that no more than 32 handles are used at the same time.		Write the user program so that no more than 32 handles are used at the same time.
Attached information	<p>Attached Information 1: Error Location</p> <p>Attached Information 2: Error Location Details (Rung Number). For a program section, the rung number from the start of the section is given. For ST, the line number is given.</p> <p>Attached Information 3: Names of the Instruction and Instruction Instance Where the Error Occurred. If there is more than one possible instruction, information is given on all of them. Nothing is given if the instruction cannot be identified.</p> <p>Attached information 4: Expansion Error Code (ErrorIDEx) is given for instructions that have Expansion Error Codes (ErrorIDEx). 0x00000000 is given for instructions that do not have Expansion Error Codes (ErrorIDEx).</p>				
Precautions/Remarks	If a program is changed after an error occurs, the attached information that is displayed may not be correct.				

Event name	CIP Timeout		Event code	54011C04 hex	
Meaning	A CIP timeout occurred during execution of a CIP communications instruction.				
Source	PLC Function Module		Source details	Instruction	Detection timing At instruction execution
Error attributes	Level	Observation	Recovery	---	Log category System
Effects	User program	Continues.	Operation	The relevant instruction will end according to specifications.	
System-defined variables	Variable	Data type		Name	
	None	---		---	
Cause and correction	Assumed cause	Correction		Prevention	
	The device with the specified IP address does not exist.	Correct the setting so that the set IP address matches the IP address of the device.		Make sure that the IP address you set matches the IP address of the device.	
	CIP connection of the specified handle is closed because the connection has timed out.	Execute the instruction within the timeout time of the connection. Or, increase the timeout time.		Make sure that the instruction is executed within the timeout time of the connection.	
	Power supply to the remote device is turned OFF.	Check the status of the remote device and start it normally.		Check the status of the remote device and start it normally.	
	Communications are stopped at the remote device.				
	CIP message communications are stopped at the remote device.	Make the device start normal CIP message communications.		Make the device start normal CIP message communications and execute the instruction.	
	The Ethernet cable for EtherNet/IP is disconnected.	Reconnect the connector and make sure it is mated correctly.		Connect the connector securely.	
	The Ethernet cable for EtherNet/IP is broken.	Replace the Ethernet cable.		None	
	Packets of the instruction are not allowed by the Firewall function or Packet Filter function of the remote device or devices on the communication path.	Allow the packets of the relevant instruction in the Firewall and Packet Filter functions of the remote device and devices on the communication path.		Allow the packets of the relevant instruction in the Firewall and Packet Filter functions of the remote device and devices on the communication path so that the device can execute the instruction.	
	Noise	Implement noise countermeasures if there is excessive noise.		Implement noise countermeasures if there is excessive noise.	
Attached information	<p>Attached Information 1: Error Location</p> <p>Attached Information 2: Error Location Details (Rung Number). For a program section, the rung number from the start of the section is given. For ST, the line number is given.</p> <p>Attached Information 3: Names of the Instruction and Instruction Instance Where the Error Occurred. If there is more than one possible instruction, information is given on all of them. Nothing is given if the instruction cannot be identified.</p> <p>Attached information 4: Expansion Error Code (ErrorIDEx) is given for instructions that have Expansion Error Codes (ErrorIDEx). 0x00000000 is given for instructions that do not have Expansion Error Codes (ErrorIDEx).</p>				
Precautions/Remarks	If a program is changed after an error occurs, the attached information that is displayed may not be correct.				

Event name	Class-3 Connection Not Established		Event code	54011C05 hex*1	
Meaning	Establishing a class-3 connection failed for a CIP communications instruction.				
Source	PLC Function Module		Source details	Instruction	Detection timing At instruction execution
Error attributes	Level	Observation	Recovery	---	Log category System
Effects	User program	Continues.	Operation	The relevant instruction will end according to specifications.	
System-defined variables	Variable	Data type		Name	
	None	---		---	
Cause and correction	Assumed cause		Correction		Prevention
	The CIPOpen instruction was executed for a device that does not support class 3 (Large_Forward_Open).		Correct the program to use the CIPOpenWithDataSize instruction for the device that does not support class 3 (Large_Forward_Open) and set the data size to less than 510 bytes.		Write the program to use the CIPOpenWithDataSize instruction for any device that does not support class 3 (Large_Forward_Open) and set the data size to less than 510 bytes.
	The CIPOpenWithDataSize instruction was executed with a specified data size of 510 bytes or larger for a device that does not support class 3 (Large_Forward_Open).		Correct the program to set the data size to less than 510 bytes in the CIPOpenWithDataSize instruction for the device that does not support class 3 (Large_Forward_Open).		Write the program to set the data size to less than 510 bytes in the CIPOpenWithDataSize instruction for any device that does not support class 3 (Large_Forward_Open).
Attached information	<p>Attached Information 1: Error Location</p> <p>Attached Information 2: Error Location Details (Rung Number). For a program section, the rung number from the start of the section is given. For ST, the line number is given.</p> <p>Attached Information 3: Names of the Instruction and Instruction Instance Where the Error Occurred. If there is more than one possible instruction, information is given on all of them. Nothing is given if the instruction cannot be identified.</p> <p>Attached information 4: Expansion Error Code (ErrorIDEx) is given for instructions that have Expansion Error Codes (ErrorIDEx). 0x00000000 is given for instructions that do not have Expansion Error Codes (ErrorIDEx).</p>				
Precautions/Remarks	If a program is changed after an error occurs, the attached information that is displayed may not be correct.				

*1. Error code 16#1C05 occurs for unit version 1.06 or later of the CPU Unit.

Event name	CIP Communications Data Size Exceeded		Event code	54011C06 hex*1	
Meaning	An attempt was made to send a class-3 explicit message with a data size that is larger than the sendable size with a CIP communications instruction.				
Source	PLC Function Module		Source details	Instruction	Detection timing At instruction execution
Error attributes	Level	Observation	Recovery	---	Log category System
Effects	User program	Continues.	Operation	The relevant instruction will end according to specifications.	
System-defined variables	Variable	Data type		Name	
	None	---		---	
Cause and correction	Assumed cause		Correction		Prevention
	The data size that was specified for the input variable to the CIP-Read, CIPWrite, or CIPSend instruction exceeded the data size that was specified with the CIPOpenWithDataSize instruction.		Correct the program so that the data size of the relevant instruction does not exceed the data size that was set with the CIPOpenWithDataSize instruction. Or, set the data size of the CIPOpenWithDataSize instruction to the data size of the relevant instruction or larger to establish a connection.		Write the program so that the data size of the relevant instruction does not exceed the data size that was set with the CIPOpenWithDataSize instruction. Or, set the data size of the CIPOpenWithDataSize instruction to the data size of the relevant instruction or larger to establish a connection.
Attached information	<p>Attached Information 1: Error Location</p> <p>Attached Information 2: Error Location Details (Rung Number). For a program section, the rung number from the start of the section is given. For ST, the line number is given.</p> <p>Attached Information 3: Names of the Instruction and Instruction Instance Where the Error Occurred. If there is more than one possible instruction, information is given on all of them. Nothing is given if the instruction cannot be identified.</p> <p>Attached information 4: Expansion Error Code (ErrorIDEx) is given for instructions that have Expansion Error Codes (ErrorIDEx). 0x00000000 is given for instructions that do not have Expansion Error Codes (ErrorIDEx).</p>				
Precautions/Remarks	If a program is changed after an error occurs, the attached information that is displayed may not be correct.				

*1. Error code 16#1C06 occurs for unit version 1.06 or later of the CPU Unit.

Event name	Local IP Address Setting Error			Event code	54012000 hex	
Meaning	An instruction was executed when there was a setting error in the local IP address.					
Source	PLC Function Module		Source details	Instruction	Detection timing	At instruction execution
Error attributes	Level	Observation	Recovery	---	Log category	System
Effects	User program	Continues.	Operation	The relevant instruction will end according to specifications.		
System-defined variables	Variable	Data type		Name		
	None	---		---		
Cause and correction	Assumed cause		Correction		Prevention	
	An instruction was executed when there was a setting error in the local IP address.		There was a TCP/IP Basic Setting Error (IP Address Setting Error) when the instruction was executed. Remove the cause of the TCP/IP Basic Setting Error.		Set the IP addresses correctly so that a TCP/IP Basic Setting Error does not occur.	
Attached information	<p>Attached Information 1: Error Location</p> <p>Attached Information 2: Error Location Details (Rung Number). For a program section, the rung number from the start of the section is given. For ST, the line number is given.</p> <p>Attached Information 3: Names of the Instruction and Instruction Instance Where the Error Occurred. If there is more than one possible instruction, information is given on all of them. Nothing is given if the instruction cannot be identified.</p> <p>Attached information 4: Expansion Error Code (ErrorIDEx) is given for instructions that have Expansion Error Codes (ErrorIDEx). 0x00000000 is given for instructions that do not have Expansion Error Codes (ErrorIDEx).</p>					
Precautions/Remarks	If a program is changed after an error occurs, the attached information that is displayed may not be correct.					

Event name	TCP/UDP Port Already in Use			Event code	54012001 hex	
Meaning	The UDP or TCP port was already in use when the instruction was executed.					
Source	PLC Function Module		Source details	Instruction	Detection timing	At instruction execution
Error attributes	Level	Observation	Recovery	---	Log category	System
Effects	User program	Continues.	Operation	The relevant instruction will end according to specifications.		
System-defined variables	Variable	Data type		Name		
	None	---		---		
Cause and correction	Assumed cause		Correction		Prevention	
	The UDP or TCP port is already in use.		Correct the user program so that an unused port is specified for the instruction.		Write the user program so that used ports are not specified for instructions.	
Attached information	<p>Attached Information 1: Error Location</p> <p>Attached Information 2: Error Location Details (Rung Number). For a program section, the rung number from the start of the section is given. For ST, the line number is given.</p> <p>Attached Information 3: Names of the Instruction and Instruction Instance Where the Error Occurred. If there is more than one possible instruction, information is given on all of them. Nothing is given if the instruction cannot be identified.</p> <p>Attached information 4: Expansion Error Code (ErrorIDEx) is given for instructions that have Expansion Error Codes (ErrorIDEx). 0x00000000 is given for instructions that do not have Expansion Error Codes (ErrorIDEx).</p>					
Precautions/Remarks	If a program is changed after an error occurs, the attached information that is displayed may not be correct.					

Event name	Address Resolution Failed		Event code	54012002 hex	
Meaning	Address resolution failed for a remote node with the host name that was specified in the instruction.				
Source	PLC Function Module		Source details	Instruction	Detection timing At instruction execution
Error attributes	Level	Observation	Recovery	---	Log category System
Effects	User program	Continues.	Operation	The relevant instruction will end according to specifications.	
System-defined variables	Variable	Data type		Name	
	None	---		---	
Cause and correction	Assumed cause	Correction		Prevention	
	The host name specified for the instruction is not correct.	Correct the domain name that is specified in the instruction.		Specify correct domain names in instructions.	
	The hosts and DNS settings in the Controller are incorrect.	Correct the hosts and DNS settings in the Controller.		Check the hosts and DNS settings in the Controller and make sure they are correct.	
	The DNS server settings are incorrect.	Correct the DNS server settings.		Check that there are no mistakes in the DNS server settings.	
Attached information	<p>Attached Information 1: Error Location</p> <p>Attached Information 2: Error Location Details (Rung Number). For a program section, the rung number from the start of the section is given. For ST, the line number is given.</p> <p>Attached Information 3: Names of the Instruction and Instruction Instance Where the Error Occurred. If there is more than one possible instruction, information is given on all of them. Nothing is given if the instruction cannot be identified.</p> <p>Attached information 4: Expansion Error Code (ErrorIDEx) is given for instructions that have Expansion Error Codes (ErrorIDEx). 0x00000000 is given for instructions that do not have Expansion Error Codes (ErrorIDEx).</p>				
Precautions/Remarks	If a program is changed after an error occurs, the attached information that is displayed may not be correct.				

Event name	Socket Status Error		Event code	54012003 hex	
Meaning	The status was not suitable for execution of the socket service instruction.				
Source	PLC Function Module		Source details	Instruction	Detection timing At instruction execution
Error attributes	Level	Observation	Recovery	---	Log category System
Effects	User program	Continues.	Operation	The relevant instruction will end according to specifications.	
System-defined variables	Variable	Data type		Name	
	None	---		---	
Cause and correction	Assumed cause		Correction		Prevention
	<ul style="list-style-type: none"> • SktUDPCreate Instruction The UDP port specified with the <i>SrcUdpPort</i> input variable is in one of the following states. <ul style="list-style-type: none"> • It is already open. • It is being closed. • SktUDPRcv Instruction <ul style="list-style-type: none"> • The specified socket is receiving data. • The specified socket is closed. • SktUDPSend Instruction <ul style="list-style-type: none"> • The specified socket is sending data. • The specified socket is closed. • SktTCPAccept Instruction The specified TCP port is in one of the following states. <ul style="list-style-type: none"> • The port is being opened. • The port is being closed. • A connection is already established for this instruction for the same IP address and TCP port. • SktTCPConnect Instruction <ul style="list-style-type: none"> • The TCP port that is specified with the <i>SrcTcpPort</i> input variable is already open. • The remote node that is specified with <i>DstAdr</i> input variable does not exist. • The remote node that is specified with <i>DstAdr</i> and <i>DstTcpPort</i> input variables is not waiting for a connection. • SktTCPRcv Instruction <ul style="list-style-type: none"> • The specified socket is receiving data. • The specified socket is closed. • The specified socket handle is already used for Secure socket communications. 		Remove the cause of the error for the instruction.		Do not execute the instruction when it will cause an error.

	<ul style="list-style-type: none"> • SktTCPSend Instruction <ul style="list-style-type: none"> • The specified socket is sending data. • The specified socket is closed. • The send buffer of the specified socket is full (because the power to the remote node is OFF, the line is disconnected, etc.) • The specified socket handle is already used for Secure socket communications. • SktClearBuf Instruction <ul style="list-style-type: none"> • The specified socket handle is already used for Secure socket communications. • [NX102 and NX1P2 Ver. 1.50 or later and NX502 Ver. 1.60 or later] <p>SktTLSConnect Instruction</p> <ul style="list-style-type: none"> • The specified socket handle is already used for Secure socket communications. • [NX102, NX502] <p>ModbusTCPCmd Instruction</p> <ul style="list-style-type: none"> • The socket is being processed. • The socket is closed. • The specified socket handle is already used for Secure socket communications. • [NX102, NX502] <p>ModbusTCPRead Instruction</p> <ul style="list-style-type: none"> • The socket is being processed. • The socket is closed. • The specified socket handle is already used for Secure socket communications. • [NX102, NX502] <p>ModbusTCPWrite Instruction</p> <ul style="list-style-type: none"> • The socket is being processed. • The socket is closed. • The specified socket handle is already used for Secure socket communications. • SktSetOption Instruction <ul style="list-style-type: none"> • The specified socket already started transmission. • An option type which is not supported by the specified socket was selected. 		
--	---	--	--

Attached information	Attached Information 1: Error Location Attached Information 2: Error Location Details (Rung Number). For a program section, the rung number from the start of the section is given. For ST, the line number is given. Attached Information 3: Names of the Instruction and Instruction Instance Where the Error Occurred. If there is more than one possible instruction, information is given on all of them. Nothing is given if the instruction cannot be identified. Attached information 4: Expansion Error Code (ErrorIDEx) is given for instructions that have Expansion Error Codes (ErrorIDEx). 0x00000000 is given for instructions that do not have Expansion Error Codes (ErrorIDEx).
Precautions/Remarks	If a program is changed after an error occurs, the attached information that is displayed may not be correct.

Event name	Local IP Address Not Set		Event code	54012004 hex	
Meaning	The local IP address was not set when a socket service instruction was executed.				
Source	PLC Function Module		Source details	Instruction	Detection timing At instruction execution
Error attributes	Level	Observation	Recovery	---	Log category System
Effects	User program	Continues.	Operation	The relevant instruction will end according to specifications.	
System-defined variables	Variable	Data type		Name	
	None	---		---	
Cause and correction	Assumed cause		Correction		Prevention
	There is a BOOTP server setting error.		Correct any errors in the BOOTP server settings.		Check that there are no mistakes in the BOOTP server settings.
	The BOOTP server does not exist.		Make sure that the BOOTP server has started normally and is normally connected to the network.		Make sure that the BOOTP server has started normally and is normally connected to the network.
	The local IP address is not set because operation just started.		Wait until the local IP address is set before executing socket service instructions.		Wait until the local IP address is set before executing socket service instructions.
Attached information	Attached Information 1: Error Location Attached Information 2: Error Location Details (Rung Number). For a program section, the rung number from the start of the section is given. For ST, the line number is given. Attached Information 3: Names of the Instruction and Instruction Instance Where the Error Occurred. If there is more than one possible instruction, information is given on all of them. Nothing is given if the instruction cannot be identified. Attached information 4: Expansion Error Code (ErrorIDEx) is given for instructions that have Expansion Error Codes (ErrorIDEx). 0x00000000 is given for instructions that do not have Expansion Error Codes (ErrorIDEx).				
Precautions/Remarks	If a program is changed after an error occurs, the attached information that is displayed may not be correct.				

Event name	Socket Timeout		Event code	54012006 hex	
Meaning	A timeout occurred for a socket service instruction.				
Source	PLC Function Module		Source details	Instruction	Detection timing At instruction execution
Error attributes	Level	Observation	Recovery	---	Log category System
Effects	User program	Continues.	Operation	The relevant instruction will end according to specifications.	
System-defined variables	Variable	Data type		Name	
	None	---		---	
Cause and correction	Assumed cause	Correction		Prevention	
	SktTCPAccept instruction: No connection request is sent from the node within the timeout time specified by the user.	Modify the system or program so that a connection request is sent from the node within the timeout time after the relevant instruction is executed. Or, increase the timeout time.		Create the system or program so that a connection request is sent from the node within the timeout time after the relevant instruction is executed.	
		Allow packets from the node in the Controller's Packet Filter settings.*1		Allow packets from the node in the Packet Filter settings of the Controller so that the node can execute the instruction.	
	SktTCPRecv instruction or SktUDPRecv instruction: Data cannot be received from the node within the timeout time specified by the user.	Modify the system or program so that data is transferred from the node within the timeout time after the relevant instruction is executed. Or, increase the timeout time.		Create the system or program so that data is transferred from the node within the timeout time after the relevant instruction is executed.	
		Allow packets from the node in the Controller's Packet Filter settings.*1		Allow packets from the node in the Packet Filter settings of the Controller so that the node can execute the instruction.	
Attached information	<p>Attached Information 1: Error Location</p> <p>Attached Information 2: Error Location Details (Rung Number). For a program section, the rung number from the start of the section is given. For ST, the line number is given.</p> <p>Attached Information 3: Names of the Instruction and Instruction Instance Where the Error Occurred. If there is more than one possible instruction, information is given on all of them. Nothing is given if the instruction cannot be identified.</p> <p>Attached information 4: Expansion Error Code (ErrorIDEx) is given for instructions that have Expansion Error Codes (ErrorIDEx). 0x00000000 is given for instructions that do not have Expansion Error Codes (ErrorIDEx).</p>				
Precautions/Remarks	If a program is changed after an error occurs, the attached information that is displayed may not be correct.				

*1. This correction is effective in any of the following CPU Units.

- NJ-series, NX102, NX1P2 CPU Unit: Version 1.49 or later
- NX701 CPU Unit: Version 1.29 or later

Event name	Socket Handle Out of Range		Event code	54012007 hex	
Meaning	The handle that is specified for the socket service instruction is not correct.				
Source	PLC Function Module		Source details	Instruction	Detection timing At instruction execution
Error attributes	Level	Observation	Recovery	---	Log category System
Effects	User program	Continues.	Operation	The relevant instruction will end according to specifications.	
System-defined variables	Variable	Data type		Name	
	None	---		---	
Cause and correction	Assumed cause		Correction		Prevention
	The handle that is specified for the socket service instruction is not correct.		Correct the socket handle for the instruction to the handle that was obtained with one of the following instructions. <ul style="list-style-type: none"> • SktUDPCreate instruction • SktTCPConnect instruction • SktTCPAccept instruction However, in the secure socket service instruction, modify the program to specify the handle obtained by the following instruction. <ul style="list-style-type: none"> • SktTCPConnect instruction 		Specify handles that are obtained with the following instructions. <ul style="list-style-type: none"> • SktUDPCreate instruction • SktTCPConnect instruction • SktTCPAccept instruction However, in the secure socket service instruction, modify the program to specify the handle obtained by the following instruction. <ul style="list-style-type: none"> • SktTCPConnect instruction
Attached information	Attached Information 1: Error Location Attached Information 2: Error Location Details (Rung Number). For a program section, the rung number from the start of the section is given. For ST, the line number is given. Attached Information 3: Names of the Instruction and Instruction Instance Where the Error Occurred. If there is more than one possible instruction, information is given on all of them. Nothing is given if the instruction cannot be identified. Attached information 4: Expansion Error Code (ErrorIDEx) is given for instructions that have Expansion Error Codes (ErrorIDEx). 0x00000000 is given for instructions that do not have Expansion Error Codes (ErrorIDEx).				
Precautions/Remarks	If a program is changed after an error occurs, the attached information that is displayed may not be correct.				

Event name	Socket Communications Resource Overflow		Event code	54012008 hex	
Meaning	The maximum resources that you can use for socket service instructions at the same time was exceeded.				
Source	PLC Function Module		Source details	Instruction	Detection timing At instruction execution
Error attributes	Level	Observation	Recovery	---	Log category System
Effects	User program	Continues.	Operation	The relevant instruction will end according to specifications.	
System-defined variables	Variable	Data type		Name	
	None	---		---	
Cause and correction	Assumed cause		Correction		Prevention
	More than 32 socket service instructions were executed at the same time (64 for NX102).		Correct the user program so that no more than 32 socket service instructions are executed at the same time (64 for NX102).		Create a user program so that no more than 32 socket service instructions are executed at the same time (64 for NX102).
	More than 30 socket handles were used at the same time (60 for NX102, 16 for CPU Units with unit version 1.02 or earlier).		Correct the user program so that no more than 30 socket handles are used at the same time (60 for NX102, 16 for CPU Units with unit version 1.02 or earlier).		Create a user program so that no more than 30 socket handles are used at the same time (60 for NX102, 16 for CPU Units with unit version 1.02 or earlier).
Attached information	<p>Attached Information 1: Error Location</p> <p>Attached Information 2: Error Location Details (Rung Number). For a program section, the rung number from the start of the section is given. For ST, the line number is given.</p> <p>Attached Information 3: Names of the Instruction and Instruction Instance Where the Error Occurred. If there is more than one possible instruction, information is given on all of them. Nothing is given if the instruction cannot be identified.</p> <p>Attached information 4: Expansion Error Code (ErrorIDEx) is given for instructions that have Expansion Error Codes (ErrorIDEx). 0x00000000 is given for instructions that do not have Expansion Error Codes (ErrorIDEx).</p>				
Precautions/Remarks	If a program is changed after an error occurs, the attached information that is displayed may not be correct.				

Event name	Invalid TLS Session Name		Event code	5401200A hex*1	
Meaning	The specified TLS session name is not found in the secure socket setting.				
Source	PLC Function Module		Source details	Instruction	Detection timing At instruction execution
Error attributes	Level	Observation	Recovery	---	Log category System
Effects	User program	Continues.	Operation	The relevant instruction will end according to specifications.	
System-defined variables	Variable	Data type		Name	
	None	---		---	
Cause and correction	Assumed cause		Correction		Prevention
	The specified TLS session name is not set in the secure socket setting.		Correct the program to specify the TLS session name that is set in the secure socket setting.		Create a program to specify the TLS session name that is set in the secure socket setting.
Attached information	<p>Attached information 1: Error Location</p> <p>Attached information 2: Error Location Details (Rung Number). For a program section, the rung number from the start of the section is given. For ST, the line number is given.</p> <p>Attached information 3: Names of the Instruction and Instruction Instance Where the Error Occurred. If there is more than one possible instruction, information is given on all of them. Nothing is given if the instruction cannot be identified.</p> <p>Attached information 4: Expansion Error Code (ErrorIDEx) is given for instructions that have Expansion Error Codes (ErrorIDEx). 0x00000000 is given for instructions that do not have Expansion Error Codes (ErrorIDEx).</p>				
Precautions/Remarks	If a program is changed after an error occurs, the attached information that is displayed may not be correct.				

*1. NX502 CPU Unit with unit version 1.60 or later, NX102-□□00 CPU Unit, NX1P2-□□□□□□ CPU Unit with unit version 1.46 or later, and NX102-□□20 CPU Unit with unit version 1.37 or later.

Event name	Access to the Certificate Failed		Event code	5401200B hex ^{*1}	
Meaning	Access to the certificate failed because the certificate and secure socket setting have not been transferred or the certificate has a password set.				
Source	PLC Function Module		Source details	Instruction	Detection timing At instruction execution
Error attributes	Level	Observation	Recovery	---	Log category System
Effects	User program	Continues.	Operation	The relevant instruction will end according to specifications.	
System-defined variables	Variable	Data type		Name	
	None	---		---	
Cause and correction	Assumed cause		Correction		Prevention
	Client certificate has not been transferred to the Controller.		Transfer the client certificate to the Controller using the Secure Socket Settings dialog box ^{*2} .		Transfer the client certificate to the Controller using the Secure Socket Settings dialog box ^{*2} before executing the instruction.
	A password has been set for the forwarded Client certificate.		Use the Secure Socket Settings dialog box ^{*2} to resend the client certificate that does not have a password set to the Controller.		Use a client certificate that does not have a password set.
	The secure socket setting does not exist or the contents of the secure socket setting are incorrect.		Create or modify the secure socket setting using the Secure Socket Settings dialog box ^{*2} using the Secure Socket Configuration commands and transfer it to the Controller.		Create a secure socket setting using the Secure Socket Settings dialog box ^{*2} and transfer it to the Controller before executing the instruction.
Attached information	<p>Attached information 1: Error Location</p> <p>Attached information 2: Error Location Details (Rung Number). For a program section, the rung number from the start of the section is given. For ST, the line number is given.</p> <p>Attached information 3: Names of the Instruction and Instruction Instance Where the Error Occurred. If there is more than one possible instruction, information is given on all of them. Nothing is given if the instruction cannot be identified.</p> <p>Attached information 4: Expansion Error Code (ErrorIDEx) is given for instructions that have Expansion Error Codes (ErrorIDEx). 0x00000000 is given for instructions that do not have Expansion Error Codes (ErrorIDEx).</p>				
Precautions/Remarks	If a program is changed after an error occurs, the attached information that is displayed may not be correct.				

*1. NX502 CPU Unit with unit version 1.60 or later, NX102-□□00 CPU Unit, NX1P2-□□□□□□ CPU Unit with unit version 1.46 or later, and NX102-□□20 CPU Unit with unit version 1.37 or later.

*2. The setting method of the secure socket service depends on the unit version and project unit version of the CPU Unit and version of the Sysmac Studio. Depending on the version, you may use the Secure Socket Settings command instead of the **Secure Socket Settings** dialog box. Refer to *Procedure to Use Secure Socket Setting Function of the Sysmac Studio* in the *NJ/NX-series CPU Unit Built-in EtherNet/IP Port User's Manual (Cat. No. W506)* for details.

Event name	TLS Session Establishment Error		Event code	5401200C hex*1	
Meaning	Establishment of a TLS session failed.				
Source	PLC Function Module		Source details	Instruction	Detection timing At instruction execution
Error attributes	Level	Observation	Recovery	---	Log category System
Effects	User program	Continues.	Operation	The relevant instruction will end according to specifications.	
System-defined variables	Variable	Data type		Name	
	None	---		---	
Cause and correction	Assumed cause		Correction		Prevention
	The contents of the Client certificate are invalid.		Transfer the Client certificate to the Controller again using the Secure Socket Settings dialog box*2.		Make sure that the Client certificate is correct.
	The contents of the Client private key are invalid.		Transfer the client private key to the Controller again using the Secure Socket Settings dialog box*2.		Make sure that the Client private key is correct.
	Establishment of Secure socket communications failed.		Enable the output of the TLS log, check the contents of the log, and take corrective action.		Enable the output of the TLS log to check that Secure communications are normal.
Attached information	<p>Attached Information 1: Error Location</p> <p>Attached Information 2: Error Location Details (Rung Number). For a program section, the rung number from the start of the section is given. For ST, the line number is given.</p> <p>Attached Information 3: Names of the Instruction and Instruction Instance Where the Error Occurred. If there is more than one possible instruction, information is given on all of them. Nothing is given if the instruction cannot be identified.</p> <p>Attached information 4: Expansion Error Code (ErrorIDEx) is given for instructions that have Expansion Error Codes (ErrorIDEx). 0x00000000 is given for instructions that do not have Expansion Error Codes (ErrorIDEx).</p>				
Precautions/Remarks	If a program is changed after an error occurs, the attached information that is displayed may not be correct.				

*1. NX502 CPU Unit with unit version 1.60 or later, NX102-□□00 CPU Unit, NX1P2-□□□□□□ CPU Unit with unit version 1.46 or later, and NX102-□□20 CPU Unit with unit version 1.37 or later.

*2. The setting method of the secure socket service depends on the unit version and project unit version of the CPU Unit and version of the Sysmac Studio. Depending on the version, you may use the Secure Socket Settings command instead of the **Secure Socket Settings** dialog box. Refer to *Procedure to Use Secure Socket Setting Function of the Sysmac Studio* in the *NJ/NX-series CPU Unit Built-in EtherNet/IP Port User's Manual (Cat. No. W506)* for details.

Event name	Invalid TLS Session Handle		Event code	5401200E hex*1	
Meaning	The TLS session handle specified by the secure socket service instruction is invalid.				
Source	PLC Function Module		Source details	Instruction	Detection timing At instruction execution
Error attributes	Level	Observation	Recovery	---	Log category System
Effects	User program	Continues.	Operation	The relevant instruction will end according to specifications.	
System-defined variables	Variable	Data type		Name	
	None	---		---	
Cause and correction	Assumed cause		Correction		Prevention
	The TLS session handle specified by the secure socket service instruction is invalid.		Correct the handle for the instruction to the handle that was obtained with the SktTLSConnect instruction.		Correct the handle for the instruction to the handle that was obtained with the SktTLSConnect instruction.
Attached information	<p>Attached Information 1: Error Location</p> <p>Attached Information 2: Error Location Details (Rung Number). For a program section, the rung number from the start of the section is given. For ST, the line number is given.</p> <p>Attached Information 3: Names of the Instruction and Instruction Instance Where the Error Occurred. If there is more than one possible instruction, information is given on all of them. Nothing is given if the instruction cannot be identified.</p> <p>Attached information 4: Expansion Error Code (ErrorIDEx) is given for instructions that have Expansion Error Codes (ErrorIDEx). 0x00000000 is given for instructions that do not have Expansion Error Codes (ErrorIDEx).</p>				
Precautions/Remarks	If a program is changed after an error occurs, the attached information that is displayed may not be correct.				

*1. NX502 CPU Unit with unit version 1.60 or later, NX102-□□00 CPU Unit, NX1P2-□□□□□□ CPU Unit with unit version 1.46 or later, and NX102-□□20 CPU Unit with unit version 1.37 or later.

Event name	TLS Error		Event code	5401200F hex *1	
Meaning	An error occurred during Secure socket communications.				
Source	PLC Function Module		Source details	Instruction	Detection timing At instruction execution
Error attributes	Level	Observation	Recovery	---	Log category System
Effects	User program	Continues.	Operation	The relevant instruction will end according to specifications.	
System-defined variables	Variable	Data type		Name	
	None	---		---	
Cause and correction	Assumed cause		Correction		Prevention
	An error occurred during Secure socket communications.		Enable the output of the TLS log, check the contents of the log, and take corrective action.		Enable the output of the TLS log to check that Secure communications are normal.
Attached information	<p>Attached Information 1: Error Location</p> <p>Attached Information 2: Error Location Details (Rung Number). For a program section, the rung number from the start of the section is given. For ST, the line number is given.</p> <p>Attached Information 3: Names of the Instruction and Instruction Instance Where the Error Occurred. If there is more than one possible instruction, information is given on all of them. Nothing is given if the instruction cannot be identified.</p> <p>Attached information 4: Expansion Error Code (ErrorIDEx) is given for instructions that have Expansion Error Codes (ErrorIDEx). 0x00000000 is given for instructions that do not have Expansion Error Codes (ErrorIDEx).</p>				
Precautions/Remarks	If a program is changed after an error occurs, the attached information that is displayed may not be correct.				

*1. NX502 CPU Unit with unit version 1.60 or later, NX102-□□00 CPU Unit, NX1P2-□□□□□□ CPU Unit with unit version 1.46 or later, and NX102-□□20 CPU Unit with unit version 1.37 or later.

Event name	No Execution Right		Event code	54012400 hex*1	
Meaning	An instruction was executed to change the settings of the EtherNet/IP port when execution was not possible.				
Source	PLC Function Module		Source details	Instruction	Detection timing At instruction execution
Error attributes	Level	Observation	Recovery	---	Log category System
Effects	User program	Continues.	Operation	Not affected.	
System-defined variables	Variable	Data type		Name	
	None	---		---	
Cause and correction	Assumed cause		Correction		Prevention
	An instruction to change the settings of the EtherNet/IP port, Ethernet port, or a CJ-series EtherNet/IP Unit was executed when restart processing was in progress for the EtherNet/IP port or Ethernet port.		Execute the instruction to change the settings after the restart or changing settings of the EtherNet/IP port, Ethernet port, and CJ-series EtherNet/IP Unit is completed.		Execute the instruction to change the settings when the restart or changing settings of the EtherNet/IP port, Ethernet port, and CJ-series EtherNet/IP Unit is not in progress.
	An instruction to change the settings of a CJ-series EtherNet/IP Unit was executed when restart processing was in progress for the Unit.				
	An instruction to change the settings of the EtherNet/IP port, Ethernet port, or a CJ-series EtherNet/IP Unit was executed while the settings for an EtherNet/IP port or Ethernet port are being changed by an instruction or CIP messages.				
	An instruction to change the settings of a CJ-series EtherNet/IP Unit was executed when changing settings was in progress for an instruction or CIP message for the Unit.				
The Unit (or unit number) specified in the instruction does not specify an EtherNet/IP port, Ethernet port, or CJ-series EtherNet/IP Unit.		Specify the EtherNet/IP port, Ethernet port or unit number of the CJ-series EtherNet/IP Unit in the instruction. If the Unit configuration is wrong, correct the Unit configuration.		Specify the EtherNet/IP port, Ethernet port or unit number of the CJ-series EtherNet/IP Unit in the instruction.	
Attached information	<p>Attached Information 1: Error Location</p> <p>Attached Information 2: Error Location Details (Rung Number). For a program section, the rung number from the start of the section is given. For ST, the line number is given.</p> <p>Attached Information 3: Names of the Instruction and Instruction Instance Where the Error Occurred. If there is more than one possible instruction, information is given on all of them. Nothing is given if the instruction cannot be identified.</p> <p>Attached information 4: Expansion Error Code (ErrorIDEx) is given for instructions that have Expansion Error Codes (ErrorIDEx). 0x00000000 is given for instructions that do not have Expansion Error Codes (ErrorIDEx).</p>				
Precautions/Remarks	If a program is changed after an error occurs, the attached information that is displayed may not be correct.				

*1. Error code 16#2400 occurs for unit version 1.02 or later of the CPU Unit.

Event name	Settings Update Failed		Event code	54012401 hex ^{*1}	
Meaning	It was not possible to update the settings of the CJ-series EtherNet/IP Unit that were changed.				
Source	PLC Function Module		Source details	Instruction	Detection timing At instruction execution
Error attributes	Level	Observation	Recovery	---	Log category System
Effects	User program	Continues.	Operation	Not affected.	
System-defined variables	Variable	Data type		Name	
	None	---		---	
Cause and correction	Assumed cause		Correction		Prevention
	Restart processing for a Unit or built-in EtherNet/IP port was started during execution of an instruction to change the settings of a CJ-series EtherNet/IP Unit.		Execute the instruction again to change the settings after restart processing for the built-in EtherNet/IP port or CJ-series EtherNet/IP Unit is completed.		Do not start restart processing for a Unit or built-in EtherNet/IP port during execution of an instruction to change the settings of a CJ-series EtherNet/IP Unit.
Attached information	<p>Attached Information 1: Error Location</p> <p>Attached Information 2: Error Location Details (Rung Number). For a program section, the rung number from the start of the section is given. For ST, the line number is given.</p> <p>Attached Information 3: Names of the Instruction and Instruction Instance Where the Error Occurred. If there is more than one possible instruction, information is given on all of them. Nothing is given if the instruction cannot be identified.</p> <p>Attached information 4: Expansion Error Code (ErrorIDEx) is given for instructions that have Expansion Error Codes (ErrorIDEx). 0x00000000 is given for instructions that do not have Expansion Error Codes (ErrorIDEx).</p>				
Precautions/Remarks	If a program is changed after an error occurs, the attached information that is displayed may not be correct.				

*1. Error code 16#2401 occurs for unit version 1.02 or later of the CPU Unit.

Event name	Too Many Simultaneous Instruction Executions		Event code	54012402 hex ^{*1}	
Meaning	Too many instructions to change the communications setup of the Controller were executed at the same time.				
Source	PLC Function Module		Source details	Instruction	Detection timing At instruction execution
Error attributes	Level	Observation	Recovery	---	Log category System
Effects	User program	Continues.	Operation	Not affected.	
System-defined variables	Variable	Data type		Name	
	None	---		---	
Cause and correction	Assumed cause		Correction		Prevention
	Two or more instructions to change the communications setup of the Controller were executed at the same time.		Correct the user program so that only one instruction to change the communications setup of the Controller is executed at the same time.		Write the user program so that only one instruction to change the communications setup of the Controller is executed at the same time.
Attached information	<p>Attached Information 1: Error Location</p> <p>Attached Information 2: Error Location Details (Rung Number). For a program section, the rung number from the start of the section is given. For ST, the line number is given.</p> <p>Attached Information 3: Names of the Instruction and Instruction Instance Where the Error Occurred. If there is more than one possible instruction, information is given on all of them. Nothing is given if the instruction cannot be identified.</p> <p>Attached information 4: Expansion Error Code (ErrorIDEx) is given for instructions that have Expansion Error Codes (ErrorIDEx). 0x00000000 is given for instructions that do not have Expansion Error Codes (ErrorIDEx).</p>				
Precautions/Remarks	If a program is changed after an error occurs, the attached information that is displayed may not be correct.				

*1. Error code 16#2402 occurs for unit version 1.02 or later of the CPU Unit.

Event name	FTP Client Execution Limit Exceeded		Event code	54012403 hex*1	
Meaning	Too many FTP client communications instructions were executed at the same time.				
Source	PLC Function Module		Source details	Instruction	Detection timing At instruction execution
Error attributes	Level	Observation	Recovery	---	Log category System
Effects	User program	Continues.	Operation	Not affected.	
System-defined variables	Variable	Data type		Name	
	None	---		---	
Cause and correction	Assumed cause		Correction		Prevention
	Four or more FTP client communications instructions were executed at the same time.		Correct the user program so that no more than three FTP client communications instructions are executed at the same time.		Write the user program so that no more than three FTP client communications instructions are executed at the same time.
Attached information	<p>Attached Information 1: Error Location</p> <p>Attached Information 2: Error Location Details (Rung Number). For a program section, the rung number from the start of the section is given. For ST, the line number is given.</p> <p>Attached Information 3: Names of the Instruction and Instruction Instance Where the Error Occurred. If there is more than one possible instruction, information is given on all of them. Nothing is given if the instruction cannot be identified.</p> <p>Attached information 4: Expansion Error Code (ErrorIDEx) is given for instructions that have Expansion Error Codes (ErrorIDEx). 0x00000000 is given for instructions that do not have Expansion Error Codes (ErrorIDEx).</p>				
Precautions/Remarks	If a program is changed after an error occurs, the attached information that is displayed may not be correct.				

*1. Error code 16#2403 occurs for unit version 1.08 or later of the CPU Unit.

Event name	File Number Limit Exceeded		Event code	54012404 hex*1	
Meaning	The number of files specified with a wildcard for an FTP client communications instruction exceeded 1,000.				
Source	PLC Function Module		Source details	Instruction	Detection timing At instruction execution
Error attributes	Level	Observation	Recovery	---	Log category System
Effects	User program	Continues.	Operation	Not affected.	
System-defined variables	Variable	Data type		Name	
	None	---		---	
Cause and correction	Assumed cause		Correction		Prevention
	The number of files specified with a file name that contained a wildcard for an FTP client communications instruction exceeded 1,000.		Correct the program so that the number of files specified with a wildcard for an FTP client communications instruction does not exceed 1,000.		Write the program so that the number of files specified with a wildcard for an FTP client communications instruction does not exceed 1,000.
Attached information	<p>Attached Information 1: Error Location</p> <p>Attached Information 2: Error Location Details (Rung Number). For a program section, the rung number from the start of the section is given. For ST, the line number is given.</p> <p>Attached Information 3: Names of the Instruction and Instruction Instance Where the Error Occurred. If there is more than one possible instruction, information is given on all of them. Nothing is given if the instruction cannot be identified.</p> <p>Attached information 4: Expansion Error Code (ErrorIDEx) is given for instructions that have Expansion Error Codes (ErrorIDEx). 0x00000000 is given for instructions that do not have Expansion Error Codes (ErrorIDEx).</p>				
Precautions/Remarks	If a program is changed after an error occurs, the attached information that is displayed may not be correct.				

*1. Error code 16#2404 occurs for unit version 1.08 or later of the CPU Unit.

Event name	Directory Does Not Exist (FTP)		Event code	54012405 hex ^{*1}	
Meaning	The directory specified for an FTP client communications instruction does not exist in the Controller or an incorrect path was specified.				
Source	PLC Function Module		Source details	Instruction	Detection timing At instruction execution
Error attributes	Level	Observation	Recovery	---	Log category System
Effects	User program	Continues.	Operation	Not affected.	
System-defined variables	Variable	Data type		Name	
	None	---		---	
Cause and correction	Assumed cause		Correction		Prevention
	The directory specified for an FTP client communications instruction does not exist in the Controller or an incorrect path was specified.		Correct the program so that the directory specified for the FTP client communications instruction exists in the SD Memory Card.		Write the program so that the directory specified for the FTP client communications instruction exists in the SD Memory Card.
Attached information	<p>Attached Information 1: Error Location</p> <p>Attached Information 2: Error Location Details (Rung Number). For a program section, the rung number from the start of the section is given. For ST, the line number is given.</p> <p>Attached Information 3: Names of the Instruction and Instruction Instance Where the Error Occurred. If there is more than one possible instruction, information is given on all of them. Nothing is given if the instruction cannot be identified.</p> <p>Attached information 4: Expansion Error Code (ErrorIDEx) is given for instructions that have Expansion Error Codes (ErrorIDEx). 0x00000000 is given for instructions that do not have Expansion Error Codes (ErrorIDEx).</p>				
Precautions/Remarks	If a program is changed after an error occurs, the attached information that is displayed may not be correct.				

*1. Error code 16#2405 occurs for unit version 1.08 or later of the CPU Unit.

Event name	FTP Server Connection Error		Event code	54012406 hex*1		
Meaning	The destination FTP server that was specified for an FTP client communications instruction does not exist on the network or the specified FTP server is not operating.					
Source	PLC Function Module	Source details	Instruction	Detection timing	At instruction execution	
Error attributes	Level	Observation	Recovery	---	Log category	System
Effects	User program	Continues.	Operation	Not affected.		
System-defined variables	Variable	Data type		Name		
	None	---		---		
Cause and correction	Assumed cause	Correction		Prevention		
	The destination FTP server specified in the FTP client communications instruction does not exist in the network.	Modify the program so that the FTP client communications instruction specifies the FTP server that exists in the network.		Create the program in which the FTP client communications instruction specifies the FTP server that exists in the network.		
	The destination FTP server specified in the FTP client communications instruction has stopped the FTP services.	Start the FTP services of the specified destination FTP server and execute the instruction again.		Make sure that the FTP services of the specified destination FTP server are not stopped and execute the instruction.		
	FTP communications are not allowed by the designated destination FTP server or the Firewall function or Packet Filter function of the devices on the communication path.	Allow FTP communications in the specified destination FTP server and Firewall and Packet Filter functions of the devices on the communication path.		Allow FTP communications in the specified destination FTP server and Firewall and Packet Filter functions of the devices on the communication path and execute the instruction.		
Attached information	<p>Attached Information 1: Error Location</p> <p>Attached Information 2: Error Location Details (Rung Number). For a program section, the rung number from the start of the section is given. For ST, the line number is given.</p> <p>Attached Information 3: Names of the Instruction and Instruction Instance Where the Error Occurred. If there is more than one possible instruction, information is given on all of them. Nothing is given if the instruction cannot be identified.</p> <p>Attached information 4: Expansion Error Code (ErrorIDEx) is given for instructions that have Expansion Error Codes (ErrorIDEx). 0x00000000 is given for instructions that do not have Expansion Error Codes (ErrorIDEx).</p>					
Precautions/Remarks	If a program is changed after an error occurs, the attached information that is displayed may not be correct.					

*1. Error code 16#2406 occurs for unit version 1.08 or later of the CPU Unit.

Event name	Destination FTP Server Execution Failure		Event code	54012407 hex ^{*1}	
Meaning	The destination FTP server for an FTP client communications instruction returned an error.				
Source	PLC Function Module		Source details	Instruction	Detection timing At instruction execution
Error attributes	Level	Observation	Recovery	---	Log category System
Effects	User program	Continues.	Operation	Not affected.	
System-defined variables	Variable	Data type		Name	
	None	---		---	
Cause and correction	Assumed cause		Correction		Prevention
	The destination FTP server failed to execute the process requested by the FTP client communications instruction.		Check the response code from the destination FTP server in the value of the <i>ErrorIDEx</i> output variable from the instruction and refer to the description in this manual for the expansion error code (<i>ErrorIDEx</i>) with the same value for the instruction.		Read the description of <i>ErrorIDEx</i> in advance for the instruction and program correctly.
	When the Controller's Packet Filter function is enabled, packets from the FTP server are not allowed.*2		Allow packets from the FTP server in the Controller's Packet Filter settings.		Allow packets from the FTP server in the Packet Filter settings of the Controller and execute the instruction.
Attached information	<p>Attached Information 1: Error Location</p> <p>Attached Information 2: Error Location Details (Rung Number). For a program section, the rung number from the start of the section is given. For ST, the line number is given.</p> <p>Attached Information 3: Names of the Instruction and Instruction Instance Where the Error Occurred. If there is more than one possible instruction, information is given on all of them. Nothing is given if the instruction cannot be identified.</p> <p>Attached Information 4: Expansion Error Code (<i>ErrorIDEx</i>)</p>				
Precautions/Remarks	If a program is changed after an error occurs, the attached information that is displayed may not be correct.				

*1. Error code 16#2407 occurs for unit version 1.08 or later of the CPU Unit.

*2. Assumed cause for the following CPU Units.

- NJ-series, NX102, NX1P2 CPU Unit: Version 1.49 or later
- NX701 CPU Unit: Version 1.29 or later

Event name	SD Memory Card Access Failed for FTP		Event code	54012408 hex*1	
Meaning	SD Memory Card access from the FTP client failed.				
Source	PLC Function Module		Source details	Instruction	Detection timing At instruction execution
Error attributes	Level	Observation	Recovery	---	Log category System
Effects	User program	Continues.	Operation	Not affected.	
System-defined variables	Variable	Data type		Name	
	None	---		---	
Cause and correction	Assumed cause		Correction		Prevention
	An SD Memory Card is not inserted.		Insert an SD Memory Card and then execute the instruction again.		Insert an SD Memory Card.
	The SD Memory Card was removed during execution of the FTP client communications instruction.		Insert an SD Memory Card and then execute the instruction again.		Do not remove the SD Memory Card during execution of the FTP client communications instruction.
	The capacity of the SD Memory Card is insufficient.		Replace the SD Memory Card for one with sufficient available capacity.		Use an SD Memory Card with sufficient available capacity.
	The SD Memory Card is write protected.		Remove write protection from the SD Memory Card.		Make sure that the SD Memory Card is not write protected.
Attached information	<p>Attached Information 1: Error Location</p> <p>Attached Information 2: Error Location Details (Rung Number). For a program section, the rung number from the start of the section is given. For ST, the line number is given.</p> <p>Attached Information 3: Names of the Instruction and Instruction Instance Where the Error Occurred. If there is more than one possible instruction, information is given on all of them. Nothing is given if the instruction cannot be identified.</p> <p>Attached information 4: Expansion Error Code (ErrorIDEx) is given for instructions that have Expansion Error Codes (ErrorIDEx). 0x00000000 is given for instructions that do not have Expansion Error Codes (ErrorIDEx).</p>				
Precautions/Remarks	If a program is changed after an error occurs, the attached information that is displayed may not be correct.				

*1. Error code 16#2408 occurs for unit version 1.08 or later of the CPU Unit.

3 Error Descriptions and Corrections

Event name	Specified File Does Not Exist		Event code	54012409 hex*1	
Meaning	A file specified for an FTP client communications instruction does not exist.				
Source	PLC Function Module		Source details	Instruction	Detection timing At instruction execution
Error attributes	Level	Observation	Recovery	---	Log category System
Effects	User program	Continues.	Operation	Not affected.	
System-defined variables	Variable	Data type		Name	
	None	---		---	
Cause and correction	Assumed cause		Correction		Prevention
	A file specified for an FTP client communications instruction does not exist.		Correct the program so that the file specified for the FTP client communications instruction exists.		Write the program so that the file specified for the FTP client communications instruction exists.
Attached information	<p>Attached Information 1: Error Location</p> <p>Attached Information 2: Error Location Details (Rung Number). For a program section, the rung number from the start of the section is given. For ST, the line number is given.</p> <p>Attached Information 3: Names of the Instruction and Instruction Instance Where the Error Occurred. If there is more than one possible instruction, information is given on all of them. Nothing is given if the instruction cannot be identified.</p> <p>Attached information 4: Expansion Error Code (ErrorIDEx) is given for instructions that have Expansion Error Codes (ErrorIDEx). 0x00000000 is given for instructions that do not have Expansion Error Codes (ErrorIDEx).</p>				
Precautions/Remarks	If a program is changed after an error occurs, the attached information that is displayed may not be correct.				

*1. Error code 16#2409 occurs for unit version 1.08 or later of the CPU Unit.

Event name	Specified File Is Write Protected		Event code	5401240A hex*1	
Meaning	The data was not transferred because the FTP client communications instruction was set to not overwrite files with the same name.				
Source	PLC Function Module		Source details	Instruction	Detection timing At instruction execution
Error attributes	Level	Observation	Recovery	---	Log category System
Effects	User program	Continues.	Operation	Not affected.	
System-defined variables	Variable	Data type		Name	
	None	---		---	
Cause and correction	Assumed cause		Correction		Prevention
	The data was not transferred because the FTP client communications instruction was set to not overwrite files with the same name and a file with the specified file name already existed at the destination.		Set the FTP client communications instruction to overwrite files with the same name and then execute the instruction again. Or, change the file name at the source or destination and then execute the instruction again.		Set the FTP client communications instruction to overwrite files with the same name. Or, make sure different file names are used at the source and destination.
Attached information	<p>Attached Information 1: Error Location</p> <p>Attached Information 2: Error Location Details (Rung Number). For a program section, the rung number from the start of the section is given. For ST, the line number is given.</p> <p>Attached Information 3: Names of the Instruction and Instruction Instance Where the Error Occurred. If there is more than one possible instruction, information is given on all of them. Nothing is given if the instruction cannot be identified.</p> <p>Attached information 4: Expansion Error Code (ErrorIDEx) is given for instructions that have Expansion Error Codes (ErrorIDEx). 0x00000000 is given for instructions that do not have Expansion Error Codes (ErrorIDEx).</p>				
Precautions/Remarks	If a program is changed after an error occurs, the attached information that is displayed may not be correct.				

*1. Error code 16#240A occurs for unit version 1.08 or later of the CPU Unit.

Event name	Failed To Delete Specified File		Event code	5401240B hex*1		
Meaning	A file was not deleted after it was transferred with an FTP client communications instruction.					
Source	PLC Function Module	Source details	Instruction	Detection timing	At instruction execution	
Error attributes	Level	Observation	Recovery	---	Log category	System
Effects	User program	Continues.	Operation	Not affected.		
System-defined variables	Variable	Data type		Name		
	None	---		---		
Cause and correction	Assumed cause	Correction		Prevention		
	The FTP client communications instruction was set to delete files after they are transferred, but it was not possible to delete the specified file because it had a read-only attribute.	Set the FTP client communications instruction to not delete files after they are transferred and then execute the instruction again. Or, change the attribute of the source file to enable writing it and then execute the instruction again.		Set the FTP client communications instruction to not delete files after they are transferred. Or do not set the attribute of source files to read-only.		
	It was not possible to delete the file specified for the FTP client communications instruction because it was in use by another application.	Execute the FTP client communications instruction when the specified file is not in use by another application.		Do not use the file specified for the FTP client communications instruction in another application.		
Attached information	<p>Attached Information 1: Error Location</p> <p>Attached Information 2: Error Location Details (Rung Number). For a program section, the rung number from the start of the section is given. For ST, the line number is given.</p> <p>Attached Information 3: Names of the Instruction and Instruction Instance Where the Error Occurred. If there is more than one possible instruction, information is given on all of them. Nothing is given if the instruction cannot be identified.</p> <p>Attached information 4: Expansion Error Code (ErrorIDEx) is given for instructions that have Expansion Error Codes (ErrorIDEx). 0x00000000 is given for instructions that do not have Expansion Error Codes (ErrorIDEx).</p>					
Precautions/Remarks	If a program is changed after an error occurs, the attached information that is displayed may not be correct.					

*1. Error code 16#240B occurs for unit version 1.08 or later of the CPU Unit.

Event name	Specified File Access Failed		Event code	5401240C hex*1	
Meaning	An FTP transfer for an FTP client communications instruction failed because file access failed.				
Source	PLC Function Module		Source details	Instruction	Detection timing At instruction execution
Error attributes	Level	Observation	Recovery	---	Log category System
Effects	User program	Continues.	Operation	Not affected.	
System-defined variables	Variable	Data type		Name	
	None	---		---	
Cause and correction	Assumed cause		Correction		Prevention
	The file specified for the FTP client communications instruction was in use by another application.		Execute the FTP client communications instruction when the specified file is not in use by another application.		Do not use the file specified for the FTP client communications instruction in another application.
	The file or directory specified for the FTP client communications instruction to write is write protected.		Remove write protection from the file specified for the FTP client communications instruction to write. Or, change the filename of the file to write.		Do not write-protect the file specified for an FTP client communications instruction to write.
Attached information	<p>Attached Information 1: Error Location</p> <p>Attached Information 2: Error Location Details (Rung Number). For a program section, the rung number from the start of the section is given. For ST, the line number is given.</p> <p>Attached Information 3: Names of the Instruction and Instruction Instance Where the Error Occurred. If there is more than one possible instruction, information is given on all of them. Nothing is given if the instruction cannot be identified.</p> <p>Attached information 4: Expansion Error Code (ErrorIDEx) is given for instructions that have Expansion Error Codes (ErrorIDEx). 0x00000000 is given for instructions that do not have Expansion Error Codes (ErrorIDEx).</p>				
Precautions/Remarks	If a program is changed after an error occurs, the attached information that is displayed may not be correct.				

*1. Error code 16#240C occurs for unit version 1.08 or later of the CPU Unit.

Event name	IP Address Setting Invalid		Event code	5401240D hex*1	
Meaning	Instruction execution was not possible because there is an error between the IP address setting of the port specified in the instruction and the other port settings.				
Source	PLC Function Module		Source details	Instruction	Detection timing At instruction execution
Error attributes	Level	Observation	Recovery	---	Log category System
Effects	User program	Continues.	Operation	Not affected.	
System-defined variables	Variable	Data type		Name	
	None	---		---	
Cause and correction	Assumed cause		Correction		Prevention
	The network address of the port specified in the instruction is the same as the network address of another port.		Correct the instruction so that it specifies a network address that is not the same as the network address of another port. Or, change the network address of the other port in advance.		When using instructions to change IP addresses, specify network addresses that are not the same as the network addresses of other ports.
	Both the port specified in the instruction and all other ports are set as unused ports.		Correct the setting of the port specified in the instruction to anything but an unused port. Or, change the unused port setting of another port in advance.		When you use an instruction to change the IP address, make sure that the port specified in the instruction and the other ports are not all set to unused ports.
Attached information	<p>Attached Information 1: Error Location</p> <p>Attached Information 2: Error Location Details (Rung Number). For a program section, the rung number from the start of the section is given. For ST, the line number is given.</p> <p>Attached Information 3: Names of the Instruction and Instruction Instance Where the Error Occurred. If there is more than one possible instruction, information is given on all of them. Nothing is given if the instruction cannot be identified.</p> <p>Attached information 4: Expansion Error Code (ErrorIDEx) is given for instructions that have Expansion Error Codes (ErrorIDEx). 0x00000000 is given for instructions that do not have Expansion Error Codes (ErrorIDEx).</p>				
Precautions/Remarks	If a program is changed after an error occurs, the attached information that is displayed may not be correct.				

*1. Error code 16#240D occurs for unit version 1.10 or later of the CPU Unit.

Event name	NX Message Error		Event code	54012C00 hex*1	
Meaning	An error response code was returned for an NX message.				
Source	PLC Function Module		Source details	Instruction	Detection timing At instruction execution
Error attributes	Level	Observation	Recovery	---	Log category System
Effects	User program	Continues.	Operation	The relevant instruction will end according to specifications.	
System-defined variables	Variable	Data type		Name	
	None	---		---	
Cause and correction	Assumed cause		Correction		Prevention
	Depends on the nature of the error.		Check the value of the <i>ErrorIDEx</i> output variable from the instruction and refer to the description in this manual of the NX message error code.		Depends on the nature of the error. Refer to the description in this manual of the NX message error code.
Attached information	<p>Attached Information 1: Error Location</p> <p>Attached Information 2: Error Location Details (Rung Number). For a program section, the rung number from the start of the section is given. For ST, the line number is given.</p> <p>Attached Information 3: Names of the Instruction and Instruction Instance Where the Error Occurred. If there is more than one possible instruction, information is given on all of them. Nothing is given if the instruction cannot be identified.</p> <p>Attached Information 4: Expansion Error Code (<i>ErrorIDEx</i>)</p>				
Precautions/Remarks	If a program is changed after an error occurs, the attached information that is displayed may not be correct.				

*1. Error code 16#2C00 occurs for unit version 1.05 or later of the CPU Unit.

Event name	NX Message Resource Overflow		Event code	54012C01 hex*1	
Meaning	The maximum resources that you can use for NX message instructions at the same time was exceeded.				
Source	PLC Function Module		Source details	Instruction	Detection timing At instruction execution
Error attributes	Level	Observation	Recovery	---	Log category System
Effects	User program	Continues.	Operation	The relevant instruction will end according to specifications.	
System-defined variables	Variable	Data type		Name	
	None	---		---	
Cause and correction	Assumed cause		Correction		Prevention
	More than 32 NX message instructions were executed at the same time.		Correct the user program so that no more than 32 NX message instructions are executed at the same time.		Write the user program so that no more than 32 NX message instructions are executed at the same time.
Attached information	<p>Attached Information 1: Error Location</p> <p>Attached Information 2: Error Location Details (Rung Number). For a program section, the rung number from the start of the section is given. For ST, the line number is given.</p> <p>Attached Information 3: Names of the Instruction and Instruction Instance Where the Error Occurred. If there is more than one possible instruction, information is given on all of them. Nothing is given if the instruction cannot be identified.</p> <p>Attached information 4: Expansion Error Code (<i>ErrorIDEx</i>) is given for instructions that have Expansion Error Codes (<i>ErrorIDEx</i>). 0x00000000 is given for instructions that do not have Expansion Error Codes (<i>ErrorIDEx</i>).</p>				
Precautions/Remarks	If a program is changed after an error occurs, the attached information that is displayed may not be correct.				

*1. Error code 16#2C01 occurs for unit version 1.05 or later of the CPU Unit.

Event name	NX Message Timeout		Event code	54012C02 hex*1	
Meaning	A timeout occurred during execution of an NX message.				
Source	PLC Function Module		Source details	Instruction	Detection timing At instruction execution
Error attributes	Level	Observation	Recovery	---	Log category System
Effects	User program	Continues.	Operation	The relevant instruction will end according to specifications.	
System-defined variables	Variable	Data type		Name	
	None	---		---	
Cause and correction	Assumed cause		Correction		Prevention
	The specified NX Unit does not exist.		Make corrections so that the Unit specification and the remote Unit configuration agree.		Make sure that Unit specifications and the remote Unit configuration agree.
	The NX message was closed because it timed out.		Increase the response timeout time that is specified for the <i>TimeOut</i> input variable in the instruction.		Execute instructions after setting suitable response timeout times for the <i>TimeOut</i> input variable.
	Power to the remote Unit is OFF.		Check the status of the remote Unit and start it normally.		Check the status of the remote Unit and start it normally.
	Communications are stopped at the remote Unit.				
	The communications cable connector is disconnected.		Reconnect the connector and make sure it is mated correctly.		Connect the connector securely.
	The communications cable is broken.		Replace the communications cable.		None
	Noise		Implement noise countermeasures if there is excessive noise.		Implement noise countermeasures if there is excessive noise.
Attached information	<p>Attached Information 1: Error Location</p> <p>Attached Information 2: Error Location Details (Rung Number). For a program section, the rung number from the start of the section is given. For ST, the line number is given.</p> <p>Attached Information 3: Names of the Instruction and Instruction Instance Where the Error Occurred. If there is more than one possible instruction, information is given on all of them. Nothing is given if the instruction cannot be identified.</p> <p>Attached information 4: Expansion Error Code (ErrorIDEx) is given for instructions that have Expansion Error Codes (ErrorIDEx). 0x00000000 is given for instructions that do not have Expansion Error Codes (ErrorIDEx).</p>				
Precautions/Remarks	If a program is changed after an error occurs, the attached information that is displayed may not be correct.				

*1. Error code 16#2C02 occurs for unit version 1.05 or later of the CPU Unit.

Event name	Incorrect NX Message Length		Event code	54012C03 hex*1	
Meaning	The length of the NX message is not correct.				
Source	PLC Function Module		Source details	Instruction	Detection timing At instruction execution
Error attributes	Level	Observation	Recovery	---	Log category System
Effects	User program	Continues.	Operation	The relevant instruction will end according to specifications.	
System-defined variables	Variable	Data type		Name	
	None	---		---	
Cause and correction	Assumed cause		Correction		Prevention
	The size that is specified for WriteDat or Path is too long.		Correct the program so that the size that is specified for WriteDat or Path is within the restriction.		Write the program so that the size that is specified for WriteDat or Path is within the restriction.
Attached information	<p>Attached Information 1: Error Location</p> <p>Attached Information 2: Error Location Details (Rung Number). For a program section, the rung number from the start of the section is given. For ST, the line number is given.</p> <p>Attached Information 3: Names of the Instruction and Instruction Instance Where the Error Occurred. If there is more than one possible instruction, information is given on all of them. Nothing is given if the instruction cannot be identified.</p> <p>Attached information 4: Expansion Error Code (ErrorIDEx) is given for instructions that have Expansion Error Codes (ErrorIDEx). 0x00000000 is given for instructions that do not have Expansion Error Codes (ErrorIDEx).</p>				
Precautions/Remarks	If a program is changed after an error occurs, the attached information that is displayed may not be correct.				

*1. Error code 16#2C03 occurs for unit version 1.05 or later of the CPU Unit.

Event name	NX Message EtherCAT Network Error		Event code	54012C05 hex*1	
Meaning	An error occurred in EtherCAT communications on the NX message path.				
Source	PLC Function Module		Source details	Instruction	Detection timing At instruction execution
Error attributes	Level	Observation	Recovery	---	Log category System
Effects	User program	Continues.	Operation	The relevant instruction will end according to specifications.	
System-defined variables	Variable	Data type		Name	
	None	---		---	
Cause and correction	Assumed cause		Correction		Prevention
	An error occurred in EtherCAT communications on the NX message path.		Check for errors in EtherCAT communications and execute the instruction after clearing any errors.		Depends on the nature of the error.
Attached information	<p>Attached Information 1: Error Location</p> <p>Attached Information 2: Error Location Details (Rung Number). For a program section, the rung number from the start of the section is given. For ST, the line number is given.</p> <p>Attached Information 3: Names of the Instruction and Instruction Instance Where the Error Occurred. If there is more than one possible instruction, information is given on all of them. Nothing is given if the instruction cannot be identified.</p> <p>Attached information 4: Expansion Error Code (ErrorIDEx) is given for instructions that have Expansion Error Codes (ErrorIDEx). 0x00000000 is given for instructions that do not have Expansion Error Codes (ErrorIDEx).</p>				
Precautions/Remarks	If a program is changed after an error occurs, the attached information that is displayed may not be correct.				

*1. Error code 16#2C05 occurs for unit version 1.05 or later of the CPU Unit.

Event name	External Restart Already Executed for Specified NX Units		Event code	54012C06 hex*1		
Meaning	A restart was already in execution from the Sysmac Studio when the instruction was executed.					
Source	PLC Function Module		Source details	Instruction	Detection timing	At instruction execution
Error attributes	Level	Observation	Recovery	---	Log category	System
Effects	User program	Continues.	Operation	The relevant instruction will end according to specifications.		
System-defined variables	Variable	Data type		Name		
	None	---		---		
Cause and correction	Assumed cause		Correction		Prevention	
	A restart was already in execution from the Sysmac Studio when the instruction was executed.		Restarting with an instruction is not necessary if a restart was already executed from the Sysmac Studio.		Do not execute restarts from the Sysmac Studio during operation.	
Attached information	<p>Attached Information 1: Error Location</p> <p>Attached Information 2: Error Location Details (Rung Number). For a program section, the rung number from the start of the section is given. For ST, the line number is given.</p> <p>Attached Information 3: Names of the Instruction and Instruction Instance Where the Error Occurred. If there is more than one possible instruction, information is given on all of them. Nothing is given if the instruction cannot be identified.</p> <p>Attached information 4: Expansion Error Code (ErrorIDEx) is given for instructions that have Expansion Error Codes (ErrorIDEx). 0x00000000 is given for instructions that do not have Expansion Error Codes (ErrorIDEx).</p>					
Precautions/Remarks	If a program is changed after an error occurs, the attached information that is displayed may not be correct.					

*1. Error code 16#2C06 occurs for unit version 1.05 or later of the CPU Unit.

Event name	Unapplicable Unit Specified for Instruction		Event code	54012C07 hex*1		
Meaning	A slave that cannot be specified for the instruction was connected at the slave node address of the specified Unit.					
Source	PLC Function Module		Source details	Instruction	Detection timing	At instruction execution
Error attributes	Level	Observation	Recovery	---	Log category	System
Effects	User program	Continues.	Operation	The relevant instruction will end according to specifications.		
System-defined variables	Variable	Data type		Name		
	None	---		---		
Cause and correction	Assumed cause		Correction		Prevention	
	A slave that cannot be specified for the instruction was connected to the slave node address of the specified Unit.		Connect the applicable Unit for the instruction that is specified in the network configuration information.		Do not connect a slave that cannot be specified for the instruction to the slave node address of the specified Unit.	
Attached information	<p>Attached Information 1: Error Location</p> <p>Attached Information 2: Error Location Details (Rung Number). For a program section, the rung number from the start of the section is given. For ST, the line number is given.</p> <p>Attached Information 3: Names of the Instruction and Instruction Instance Where the Error Occurred. If there is more than one possible instruction, information is given on all of them. Nothing is given if the instruction cannot be identified.</p> <p>Attached information 4: Expansion Error Code (ErrorIDEx) is given for instructions that have Expansion Error Codes (ErrorIDEx). 0x00000000 is given for instructions that do not have Expansion Error Codes (ErrorIDEx).</p>					
Precautions/Remarks	If a program is changed after an error occurs, the attached information that is displayed may not be correct.					

*1. Error code 16#2C07 occurs for unit version 1.05 or later of the CPU Unit.

Event name	Invalid Total Power ON Time Record		Event code	54012C08 hex*1	
Meaning	Failed to read the total power ON time.				
Source	PLC Function Module		Source details	Instruction	Detection timing At instruction execution
Error attributes	Level	Observation	Recovery	---	Log category System
Effects	User program	Continues.	Operation	The relevant instruction will end according to specifications.	
System-defined variables	Variable	Data type		Name	
	None	---		---	
Cause and correction	Assumed cause		Correction		Prevention
	Non-volatile memory failure		Replace the Unit from which the total power ON time cannot be read.		None
Attached information	<p>Attached Information 1: Error Location</p> <p>Attached Information 2: Error Location Details (Rung Number). For a program section, the rung number from the start of the section is given. For ST, the line number is given.</p> <p>Attached Information 3: Names of the Instruction and Instruction Instance Where the Error Occurred. If there is more than one possible instruction, information is given on all of them. Nothing is given if the instruction cannot be identified.</p> <p>Attached information 4: Expansion Error Code (ErrorIDEx) is given for instructions that have Expansion Error Codes (ErrorIDEx). 0x00000000 is given for instructions that do not have Expansion Error Codes (ErrorIDEx).</p>				
Precautions/Remarks	If a program is changed after an error occurs, the attached information that is displayed may not be correct.				

*1. Error code 16#2C08 occurs for unit version 1.10 or later of the CPU Unit.

Event name	Process Data Object Setting Missing		Event code	54013461 hex	
Meaning	The PDO mapping is not correct.				
Source	PLC Function Module		Source details	Instruction	Detection timing At instruction execution
Error attributes	Level	Observation	Recovery	---	Log category System
Effects	User program	Continues.	Operation	The relevant instruction will end according to specifications.	
System-defined variables	Variable	Data type		Name	
	_MC_AX[*].MFaultLvl.Active	BOOL		Axis Minor Fault Occurrence	
Cause and correction	Assumed cause	Correction		Prevention	
	The PDOs that are required for the motion control instruction are not mapped.	Map the PDOs that are required for the instruction. Refer to the Function section of the relevant instruction for the required PDOs.		Map the PDOs that are required for the instructions that are used. Refer to the <i>NJ/NX-series CPU Unit Motion Control User's Manual (Cat. No. W507)</i> for the PDOs (Servo Drive settings) that you must map for each instruction.	
	The relevant instruction was executed for a device that does not have an object that supports the instruction.	Some devices do not support the relevant instruction. Refer to the manual for the target device, check to see if the relevant instruction is supported, and correct the program so that unsupported instructions are not executed.		Refer to the manual for the target device and write the program so that unsupported instructions are not executed.	
	A motion control instruction that specifies phase Z (_mcEncoder-Mark) as the trigger conditions was executed for an axis that is mapped to an OMRON GX-EC02□□ EtherCAT Encoder slave.	Use an external input (_mcEXT) as the trigger conditions for an axis that is mapped to an OMRON GX-EC02□□ EtherCAT Encoder slave.		Use an external input (_mcEXT) as the trigger conditions for an axis that is mapped to an OMRON GX-EC02□□ EtherCAT Encoder slave.	
Attached information	Attached Information 1: Error Location Attached Information 3: Names of the Instruction and Instruction Instance Where the Error Occurred. If there is more than one possible instruction, information is given on all of them. Nothing is given if the instruction cannot be identified.				
Precautions/Remarks	If a program is changed after an error occurs, the attached information that is displayed may not be correct.				

Event name	Device Error Received		Event code	54014800 hex*1		
Meaning	An error response from the device was received.					
Source	PLC Function Module		Source details	Instruction	Detection timing	At instruction execution
Error attributes	Level	Observation	Recovery	---	Log category	System
Effects	User program	Continues.	Operation	The relevant instruction will end according to specifications.		
System-defined variables	Variable	Data type		Name		
	None	---		---		
Cause and correction	Assumed cause		Correction		Prevention	
	An error response from the device was received.		The error code that is returned by the device is output to the Error-Type output variable of the instruction. Check the error information in the manual for the target device and correct the problem.		Check the error cause in the manual for the device before you write the user program and execute the instruction.	
Attached information	<p>Attached Information 1: Error Location</p> <p>Attached Information 2: Error Location Details (Rung Number). For a program section, the rung number from the start of the section is given. For ST, the line number is given.</p> <p>Attached Information 3: Names of the Instruction and Instruction Instance Where the Error Occurred. If there is more than one possible instruction, information is given on all of them. Nothing is given if the instruction cannot be identified.</p> <p>Attached Information 4: Expansion Error Code (ErrorType)</p>					
Precautions/Remarks	If a program is changed after an error occurs, the attached information that is displayed may not be correct.					

*1. Error code 16#4800 occurs for unit version 1.12 or later of the CPU Unit.

Event name	Specified Unit Does Not Exist		Event code	54014801 hex*1		
Meaning	The specified Unit does not exist.					
Source	PLC Function Module		Source details	Instruction	Detection timing	At instruction execution
Error attributes	Level	Observation	Recovery	---	Log category	System
Effects	User program	Continues.	Operation	The relevant instruction will end according to specifications.		
System-defined variables	Variable	Data type		Name		
	None	---		---		
Cause and correction	Assumed cause		Correction		Prevention	
	The IO-Link master is not connected to or mounted on the specified position.		Connect or mount the IO-Link master to or on the specified position. Or, specify the position where the IO-Link master is connected or mounted.		Connect or mount the IO-Link master to or on the specified position. Or, specify the position where the IO-Link master is connected or mounted.	
Attached information	<p>Attached Information 1: Error Location</p> <p>Attached Information 2: Error Location Details (Rung Number). For a program section, the rung number from the start of the section is given. For ST, the line number is given.</p> <p>Attached Information 3: Names of the Instruction and Instruction Instance Where the Error Occurred. If there is more than one possible instruction, information is given on all of them. Nothing is given if the instruction cannot be identified.</p> <p>Attached Information 4: Expansion Error Code (ErrorType)</p>					
Precautions/Remarks	If a program is changed after an error occurs, the attached information that is displayed may not be correct.					

*1. Error code 16#4801 occurs for unit version 1.12 or later of the CPU Unit.

Event name	Message Processing Limit Exceeded		Event code	54014802 hex*1	
Meaning	An instruction cannot be executed because the IO-Link master is processing the message from another application.				
Source	PLC Function Module		Source details	Instruction	Detection timing At instruction execution
Error attributes	Level	Observation	Recovery	---	Log category System
Effects	User program	Continues.	Operation	The relevant instruction will end according to specifications.	
System-defined variables	Variable	Data type		Name	
	None	---		---	
Cause and correction	Assumed cause		Correction		Prevention
	An instruction cannot be executed because the IO-Link master is processing the message from another application (an instruction execution or a tool connection).		Execute the instruction again.		Perform processing for exclusive control of messages in applications (an instruction execution or a tool connection). Or, increase the number of retries.
Attached information	Attached Information 1: Error Location Attached Information 2: Error Location Details (Rung Number). For a program section, the rung number from the start of the section is given. For ST, the line number is given. Attached Information 3: Names of the Instruction and Instruction Instance Where the Error Occurred. If there is more than one possible instruction, information is given on all of them. Nothing is given if the instruction cannot be identified. Attached Information 4: Expansion Error Code (ErrorType)				
Precautions/Remarks	If a program is changed after an error occurs, the attached information that is displayed may not be correct.				

*1. Error code 16#4802 occurs for unit version 1.12 or later of the CPU Unit.

Event name	Specified Unit Status Error		Event code	54014803 hex*1	
Meaning	The specified Unit is not in a condition to receive messages.				
Source	PLC Function Module		Source details	Instruction	Detection timing At instruction execution
Error attributes	Level	Observation	Recovery	---	Log category System
Effects	User program	Continues.	Operation	The relevant instruction will end according to specifications.	
System-defined variables	Variable	Data type		Name	
	None	---		---	
Cause and correction	Assumed cause		Correction		Prevention
	The specified Unit is not in a condition to receive messages.		Execute the instruction again.		When this error occurs, execute the instruction again.
Attached information	Attached Information 1: Error Location Attached Information 2: Error Location Details (Rung Number). For a program section, the rung number from the start of the section is given. For ST, the line number is given. Attached Information 3: Names of the Instruction and Instruction Instance Where the Error Occurred. If there is more than one possible instruction, information is given on all of them. Nothing is given if the instruction cannot be identified. Attached Information 4: Expansion Error Code (ErrorType)				
Precautions/Remarks	If a program is changed after an error occurs, the attached information that is displayed may not be correct.				

*1. Error code 16#4803 occurs for unit version 1.12 or later of the CPU Unit.

Event name	Too Many Simultaneous Instruction Executions		Event code	54014804 hex ^{*1}	
Meaning	The number of instructions that can be simultaneously executed was exceeded.				
Source	PLC Function Module		Source details	Instruction	Detection timing At instruction execution
Error attributes	Level	Observation	Recovery	---	Log category System
Effects	User program	Continues.	Operation	The relevant instruction will end according to specifications.	
System-defined variables	Variable	Data type		Name	
	None	---		---	
Cause and correction	Assumed cause		Correction		Prevention
	More than 32 NX message instructions and EtherCAT communications instructions were executed at the same time.		Correct the user program so that no more than 32 NX message instructions and EtherCAT communications instructions are executed at the same time.		Write the user program so that no more than 32 NX message instructions and EtherCAT communications instructions are executed at the same time.
Attached information	<p>Attached Information 1: Error Location</p> <p>Attached Information 2: Error Location Details (Rung Number). For a program section, the rung number from the start of the section is given. For ST, the line number is given.</p> <p>Attached Information 3: Names of the Instruction and Instruction Instance Where the Error Occurred. If there is more than one possible instruction, information is given on all of them. Nothing is given if the instruction cannot be identified.</p> <p>Attached Information 4: Expansion Error Code (ErrorType)</p>				
Precautions/Remarks	If a program is changed after an error occurs, the attached information that is displayed may not be correct.				

*1. Error code 16#4804 occurs for unit version 1.12 or later of the CPU Unit.

Event name	Communications Timeout		Event code	54014805 hex*1		
Meaning	A timeout occurred in communications.					
Source	PLC Function Module		Source details	Instruction	Detection timing	At instruction execution
Error attributes	Level	Observation	Recovery	---	Log category	System
Effects	User program	Continues.	Operation	The relevant instruction will end according to specifications.		
System-defined variables	Variable	Data type		Name		
	None	---		---		
Cause and correction	Assumed cause		Correction		Prevention	
	The communications timeout time is shorter than the message response time.		Calculate the message response time, and make a setting so that the communications timeout time is longer than the message response time.		Calculate the message response time, and make a setting so that the communications timeout time is longer than the message response time.	
	The cable for EtherCAT or for IO-Link is broken.		Replace the cable.		None	
	Noise		Implement noise countermeasures.		Implement noise countermeasures.	
	Device failure		Replace the relevant device.		None	
Attached information	Attached Information 1: Error Location Attached Information 2: Error Location Details (Rung Number). For a program section, the rung number from the start of the section is given. For ST, the line number is given. Attached Information 3: Names of the Instruction and Instruction Instance Where the Error Occurred. If there is more than one possible instruction, information is given on all of them. Nothing is given if the instruction cannot be identified. Attached Information 4: Expansion Error Code (ErrorType)					
Precautions/Remarks	If a program is changed after an error occurs, the attached information that is displayed may not be correct.					

*1. Error code 16#4805 occurs for unit version 1.12 or later of the CPU Unit.

Event name	Invalid Mode		Event code	54014806 hex*1		
Meaning	The specified IO-Link master port is not the IO-Link mode.					
Source	PLC Function Module		Source details	Instruction	Detection timing	At instruction execution
Error attributes	Level	Observation	Recovery	---	Log category	System
Effects	User program	Continues.	Operation	The relevant instruction will end according to specifications.		
System-defined variables	Variable	Data type		Name		
	None	---		---		
Cause and correction	Assumed cause		Correction		Prevention	
	The specified IO-Link master port is not the IO-Link mode.		Set the specified IO-Link master port to the IO-Link mode, and execute the instruction again.		Set the IO-Link master port to specify to the IO-Link mode, and execute the instruction.	
Attached information	Attached Information 1: Error Location Attached Information 2: Error Location Details (Rung Number). For a program section, the rung number from the start of the section is given. For ST, the line number is given. Attached Information 3: Names of the Instruction and Instruction Instance Where the Error Occurred. If there is more than one possible instruction, information is given on all of them. Nothing is given if the instruction cannot be identified. Attached Information 4: Expansion Error Code (ErrorType)					
Precautions/Remarks	If a program is changed after an error occurs, the attached information that is displayed may not be correct.					

*1. Error code 16#4806 occurs for unit version 1.12 or later of the CPU Unit.

Event name	I/O Power OFF Status		Event code	54014807 hex*1		
Meaning	The I/O power is not supplied to the specified IO-Link master port.					
Source	PLC Function Module		Source details	Instruction	Detection timing	At instruction execution
Error attributes	Level	Observation	Recovery	---	Log category	System
Effects	User program	Continues.	Operation	The relevant instruction will end according to specifications.		
System-defined variables	Variable	Data type		Name		
	None	---		---		
Cause and correction	Assumed cause		Correction		Prevention	
	The I/O power is not supplied to the specified IO-Link master port.		Supply the I/O power to the specified IO-Link master port, and then execute the instruction.		Make sure that an I/O power is supplied to the specified IO-Link master port before you execute the instruction.	
Attached information	<p>Attached Information 1: Error Location</p> <p>Attached Information 2: Error Location Details (Rung Number). For a program section, the rung number from the start of the section is given. For ST, the line number is given.</p> <p>Attached Information 3: Names of the Instruction and Instruction Instance Where the Error Occurred. If there is more than one possible instruction, information is given on all of them. Nothing is given if the instruction cannot be identified.</p> <p>Attached Information 4: Expansion Error Code (ErrorType)</p>					
Precautions/Remarks	If a program is changed after an error occurs, the attached information that is displayed may not be correct.					

*1. Error code 16#4807 occurs for unit version 1.12 or later of the CPU Unit.

Event name	Verification Error		Event code	54014808 hex*1		
Meaning	The specified IO-Link master port had a verification error or a communications error.					
Source	PLC Function Module		Source details	Instruction	Detection timing	At instruction execution
Error attributes	Level	Observation	Recovery	---	Log category	System
Effects	User program	Continues.	Operation	The relevant instruction will end according to specifications.		
System-defined variables	Variable	Data type		Name		
	None	---		---		
Cause and correction	Assumed cause		Correction		Prevention	
	The specified IO-Link master port had a verification error or a communications error.		Clear the error, and then execute the instruction again.		Execute the instruction while there is no error.	
Attached information	<p>Attached Information 1: Error Location</p> <p>Attached Information 2: Error Location Details (Rung Number). For a program section, the rung number from the start of the section is given. For ST, the line number is given.</p> <p>Attached Information 3: Names of the Instruction and Instruction Instance Where the Error Occurred. If there is more than one possible instruction, information is given on all of them. Nothing is given if the instruction cannot be identified.</p> <p>Attached Information 4: Expansion Error Code (ErrorType)</p>					
Precautions/Remarks	If a program is changed after an error occurs, the attached information that is displayed may not be correct.					

*1. Error code 16#4808 occurs for unit version 1.12 or later of the CPU Unit.

Event name	Incorrect Device Port Setting		Event code	54014809 hex *1	
Meaning	The device port settings are not correct.				
Source	PLC Function Module		Source details	Instruction	Detection timing At instruction execution
Error attributes	Level	Observation	Recovery	---	Log category System
Effects	User program	Continues.	Operation	The relevant instruction will end according to specifications.	
System-defined variables	Variable	Data type		Name	
	None	---		---	
Cause and correction	Assumed cause		Correction		Prevention
	The device port settings are not correct.		Confirm the type of an IO-Link Master Unit and then confirm the device type, specified Unit, specified slave, and port number of the device port.		Set the device type, specified Unit, specified slave, and port number of the device port in accordance with the type of an IO-Link Master Unit.
Attached information	Attached Information 1: Error Location Attached Information 2: Error Location Details (Rung Number). For a program section, the rung number from the start of the section is given. For ST, the line number is given. Attached Information 3: Names of the Instruction and Instruction Instance Where the Error Occurred. If there is more than one possible instruction, information is given on all of them. Nothing is given if the instruction cannot be identified. Attached Information 4: Expansion Error Code (ErrorType)				
Precautions/Remarks	If a program is changed after an error occurs, the attached information that is displayed may not be correct.				

*1. Error code 16#4809 occurs for unit version 1.12 or later of the CPU Unit.

Event name	Electronic Gear Ratio Numerator Setting Out of Range		Event code	54015420 hex	
Meaning	The parameter specified for the <i>RatioNumerator</i> input variable to a motion control instruction is out of range.				
Source	PLC Function Module		Source details	Instruction	Detection timing At instruction execution
Error attributes	Level	Observation	Recovery	---	Log category System
Effects	User program	Continues.	Operation	The relevant instruction will end according to specifications.	
System-defined variables	Variable	Data type		Name	
	_MC_AX[*].MFaultLvl.Active	BOOL		Axis Minor Fault Occurrence	
Cause and correction	Assumed cause		Correction		Prevention
	Instruction input parameter exceeded the valid range of the input variable.		Correct the parameter so that the valid range of the input variable is not exceeded for the relevant instruction.		Set the input parameter to the instruction so that the valid range of the input variable is not exceeded.
Attached information	Attached Information 1: Error Location Attached Information 3: Names of the Instruction and Instruction Instance Where the Error Occurred. If there is more than one possible instruction, information is given on all of them. Nothing is given if the instruction cannot be identified.				
Precautions/Remarks	If a program is changed after an error occurs, the attached information that is displayed may not be correct.				

3 Error Descriptions and Corrections

Event name	Electronic Gear Ratio Denominator Setting Out of Range		Event code	54015421 hex		
Meaning	The parameter specified for the <i>RatioDenominator</i> input variable to a motion control instruction is out of range.					
Source	PLC Function Module		Source details	Instruction	Detection timing	At instruction execution
Error attributes	Level	Observation	Recovery	---	Log category	System
Effects	User program	Continues.	Operation	The relevant instruction will end according to specifications.		
System-defined variables	Variable		Data type		Name	
	_MC_AX[*].MFaultLvl.Active		BOOL		Axis Minor Fault Occurrence	
Cause and correction	Assumed cause		Correction		Prevention	
	Instruction input parameter exceeded the valid range of the input variable.		Correct the parameter so that the valid range of the input variable is not exceeded for the relevant instruction.		Set the input parameter to the instruction so that the valid range of the input variable is not exceeded.	
Attached information	Attached Information 1: Error Location Attached Information 3: Names of the Instruction and Instruction Instance Where the Error Occurred. If there is more than one possible instruction, information is given on all of them. Nothing is given if the instruction cannot be identified.					
Precautions/Remarks	If a program is changed after an error occurs, the attached information that is displayed may not be correct.					

Event name	Target Velocity Setting Out of Range		Event code	54015422 hex		
Meaning	The parameter specified for the <i>Velocity</i> input variable to a motion control instruction is out of range.					
Source	PLC Function Module		Source details	Instruction	Detection timing	At instruction execution
Error attributes	Level	Observation	Recovery	---	Log category	System
Effects	User program	Continues.	Operation	The relevant instruction will end according to specifications.		
System-defined variables	Variable		Data type		Name	
	_MC_AX[*].MFaultLvl.Active		BOOL		Axis Minor Fault Occurrence	
	_MC_GRP[*].MFaultLvl.Active		BOOL		Axes Group Minor Fault Occurrence	
Cause and correction	Assumed cause		Correction		Prevention	
	Instruction input parameter exceeded the valid range of the input variable.		Correct the parameter so that the valid range of the input variable is not exceeded for the relevant instruction.		Set the input parameter to the instruction so that the valid range of the input variable is not exceeded.	
Attached information	Attached Information 1: Error Location Attached Information 3: Names of the Instruction and Instruction Instance Where the Error Occurred. If there is more than one possible instruction, information is given on all of them. Nothing is given if the instruction cannot be identified.					
Precautions/Remarks	If a program is changed after an error occurs, the attached information that is displayed may not be correct.					

Event name	Acceleration Setting Out of Range			Event code	54015423 hex	
Meaning	The parameter specified for the <i>Acceleration</i> input variable to a motion control instruction is out of range.					
Source	PLC Function Module		Source details	Instruction	Detection timing	At instruction execution
Error attributes	Level	Observation	Recovery	---	Log category	System
Effects	User program	Continues.	Operation	The relevant instruction will end according to specifications.		
System-defined variables	Variable		Data type		Name	
	_MC_AX[*].MFAultLvl.Active		BOOL		Axis Minor Fault Occurrence	
	_MC_GRP[*].MFAultLvl.Active		BOOL		Axes Group Minor Fault Occurrence	
Cause and correction	Assumed cause		Correction		Prevention	
	Instruction input parameter exceeded the valid range of the input variable.		Correct the parameter so that the valid range of the input variable is not exceeded for the relevant instruction.		Set the input parameter to the instruction so that the valid range of the input variable is not exceeded.	
Attached information	Attached Information 1: Error Location Attached Information 3: Names of the Instruction and Instruction Instance Where the Error Occurred. If there is more than one possible instruction, information is given on all of them. Nothing is given if the instruction cannot be identified.					
Precautions/Remarks	If a program is changed after an error occurs, the attached information that is displayed may not be correct.					

Event name	Deceleration Setting Out of Range			Event code	54015424 hex	
Meaning	The parameter specified for the <i>Deceleration</i> input variable to a motion control instruction is out of range.					
Source	PLC Function Module		Source details	Instruction	Detection timing	At instruction execution
Error attributes	Level	Observation	Recovery	---	Log category	System
Effects	User program	Continues.	Operation	The relevant instruction will end according to specifications.		
System-defined variables	Variable		Data type		Name	
	_MC_AX[*].MFAultLvl.Active		BOOL		Axis Minor Fault Occurrence	
	_MC_GRP[*].MFAultLvl.Active		BOOL		Axes Group Minor Fault Occurrence	
Cause and correction	Assumed cause		Correction		Prevention	
	Instruction input parameter exceeded the valid range of the input variable.		Correct the parameter so that the valid range of the input variable is not exceeded for the relevant instruction.		Set the input parameter to the instruction so that the valid range of the input variable is not exceeded.	
Attached information	Attached Information 1: Error Location Attached Information 3: Names of the Instruction and Instruction Instance Where the Error Occurred. If there is more than one possible instruction, information is given on all of them. Nothing is given if the instruction cannot be identified.					
Precautions/Remarks	If a program is changed after an error occurs, the attached information that is displayed may not be correct.					

3 Error Descriptions and Corrections

Event name	Jerk Setting Out of Range			Event code	54015425 hex	
Meaning	The parameter specified for the <i>Jerk</i> input variable to a motion control instruction is out of range.					
Source	PLC Function Module		Source details	Instruction	Detection timing	At instruction execution
Error attributes	Level	Observation	Recovery	---	Log category	System
Effects	User program	Continues.	Operation	The relevant instruction will end according to specifications.		
System-defined variables	Variable		Data type		Name	
	_MC_AX[*].MFAultLvl.Active		BOOL		Axis Minor Fault Occurrence	
	_MC_GRP[*].MFAultLvl.Active		BOOL		Axes Group Minor Fault Occurrence	
Cause and correction	Assumed cause		Correction		Prevention	
	Instruction input parameter exceeded the valid range of the input variable.		Correct the parameter so that the valid range of the input variable is not exceeded for the relevant instruction.		Set the input parameter to the instruction so that the valid range of the input variable is not exceeded.	
Attached information	Attached Information 1: Error Location Attached Information 3: Names of the Instruction and Instruction Instance Where the Error Occurred. If there is more than one possible instruction, information is given on all of them. Nothing is given if the instruction cannot be identified.					
Precautions/Remarks	If a program is changed after an error occurs, the attached information that is displayed may not be correct.					

Event name	Torque Ramp Setting Out of Range			Event code	54015427 hex	
Meaning	The parameter specified for the <i>TorqueRamp</i> input variable to a motion control instruction is out of range.					
Source	PLC Function Module		Source details	Instruction	Detection timing	At instruction execution
Error attributes	Level	Observation	Recovery	---	Log category	System
Effects	User program	Continues.	Operation	The relevant instruction will end according to specifications.		
System-defined variables	Variable		Data type		Name	
	_MC_AX[*].MFAultLvl.Active		BOOL		Axis Minor Fault Occurrence	
	_MC_GRP[*].MFAultLvl.Active		BOOL		Axes Group Minor Fault Occurrence	
Cause and correction	Assumed cause		Correction		Prevention	
	Instruction input parameter exceeded the valid range of the input variable.		Correct the parameter so that the valid range of the input variable is not exceeded for the relevant instruction.		Set the input parameter to the instruction so that the valid range of the input variable is not exceeded.	
Attached information	Attached Information 1: Error Location Attached Information 3: Names of the Instruction and Instruction Instance Where the Error Occurred. If there is more than one possible instruction, information is given on all of them. Nothing is given if the instruction cannot be identified.					
Precautions/Remarks	If a program is changed after an error occurs, the attached information that is displayed may not be correct.					

Event name	Master Coefficient Scaling Out of Range		Event code	54015428 hex	
Meaning	The parameter specified for the <i>MasterScaling</i> input variable to a motion control instruction is out of range.				
Source	PLC Function Module		Source details	Instruction	Detection timing At instruction execution
Error attributes	Level	Observation	Recovery	---	Log category System
Effects	User program	Continues.	Operation	The relevant instruction will end according to specifications.	
System-defined variables	Variable		Data type		Name
	_MC_AX[*].MFAultLvl.Active		BOOL		Axis Minor Fault Occurrence
Cause and correction	Assumed cause		Correction		Prevention
	Instruction input parameter exceeded the valid range of the input variable.		Correct the parameter so that the valid range of the input variable is not exceeded for the relevant instruction.		Set the input parameter to the instruction so that the valid range of the input variable is not exceeded.
Attached information	Attached Information 1: Error Location Attached Information 3: Names of the Instruction and Instruction Instance Where the Error Occurred. If there is more than one possible instruction, information is given on all of them. Nothing is given if the instruction cannot be identified.				
Precautions/Remarks	If a program is changed after an error occurs, the attached information that is displayed may not be correct.				

Event name	Slave Coefficient Scaling Out of Range		Event code	54015429 hex	
Meaning	The parameter specified for the <i>SlaveScaling</i> input variable to a motion control instruction is out of range.				
Source	PLC Function Module		Source details	Instruction	Detection timing At instruction execution
Error attributes	Level	Observation	Recovery	---	Log category System
Effects	User program	Continues.	Operation	The relevant instruction will end according to specifications.	
System-defined variables	Variable		Data type		Name
	_MC_AX[*].MFAultLvl.Active		BOOL		Axis Minor Fault Occurrence
Cause and correction	Assumed cause		Correction		Prevention
	Instruction input parameter exceeded the valid range of the input variable.		Correct the parameter so that the valid range of the input variable is not exceeded for the relevant instruction.		Set the input parameter to the instruction so that the valid range of the input variable is not exceeded.
Attached information	Attached Information 1: Error Location Attached Information 3: Names of the Instruction and Instruction Instance Where the Error Occurred. If there is more than one possible instruction, information is given on all of them. Nothing is given if the instruction cannot be identified.				
Precautions/Remarks	If a program is changed after an error occurs, the attached information that is displayed may not be correct.				

Event name	Feeding Velocity Setting Out of Range		Event code	5401542A hex		
Meaning	The parameter specified for the <i>FeedVelocity</i> input variable to a motion control instruction is out of range.					
Source	PLC Function Module		Source details	Instruction	Detection timing	At instruction execution
Error attributes	Level	Observation	Recovery	---	Log category	System
Effects	User program	Continues.	Operation	The relevant instruction will end according to specifications.		
System-defined variables	Variable		Data type		Name	
	_MC_AX[*].MFAultLvl.Active		BOOL		Axis Minor Fault Occurrence	
Cause and correction	Assumed cause		Correction		Prevention	
	The Feed Velocity (input variable <i>FeedVelocity</i>) is still at the default (0).		Specify a positive value for the Feed Velocity (input variable <i>FeedVelocity</i>).		Set the input parameter to the instruction so that the valid range of the input variable is not exceeded.	
Attached information	Attached Information 1: Error Location Attached Information 3: Names of the Instruction and Instruction Instance Where the Error Occurred. If there is more than one possible instruction, information is given on all of them. Nothing is given if the instruction cannot be identified.					
Precautions/Remarks	If a program is changed after an error occurs, the attached information that is displayed may not be correct.					

Event name	Buffer Mode Selection Out of Range		Event code	5401542B hex		
Meaning). <i>BufferMode</i> input variable to a motion control instruction is out of range.					
Source	PLC Function Module		Source details	Instruction	Detection timing	At instruction execution
Error attributes	Level	Observation	Recovery	---	Log category	System
Effects	User program	Continues.	Operation	The relevant instruction will end according to specifications.		
System-defined variables	Variable		Data type		Name	
	_MC_AX[*].MFAultLvl.Active		BOOL		Axis Minor Fault Occurrence	
	_MC_GRP[*].MFAultLvl.Active		BOOL		Axes Group Minor Fault Occurrence	
Cause and correction	Assumed cause		Correction		Prevention	
	Instruction input parameter exceeded the valid range of the input variable.		Correct the parameter so that the valid range of the input variable is not exceeded for the relevant instruction.		Set the input parameter to the instruction so that the valid range of the input variable is not exceeded.	
Attached information	Attached Information 1: Error Location Attached Information 3: Names of the Instruction and Instruction Instance Where the Error Occurred. If there is more than one possible instruction, information is given on all of them. Nothing is given if the instruction cannot be identified.					
Precautions/Remarks	If a program is changed after an error occurs, the attached information that is displayed may not be correct.					

Event name	Coordinate System Selection Out of Range		Event code	5401542C hex	
Meaning	The parameter specified for the <i>CoordSystem</i> input variable to a motion control instruction is out of range.				
Source	PLC Function Module		Source details	Instruction	Detection timing At instruction execution
Error attributes	Level	Observation	Recovery	---	Log category System
Effects	User program	Continues.	Operation	The relevant instruction will end according to specifications.	
System-defined variables	Variable		Data type		Name
	_MC_GRP[*].MFAultLvl.Active		BOOL		Axes Group Minor Fault Occurrence
Cause and correction	Assumed cause		Correction		Prevention
	Instruction input parameter exceeded the valid range of the input variable.		Correct the parameter so that the valid range of the input variable is not exceeded for the relevant instruction.		Set the input parameter to the instruction so that the valid range of the input variable is not exceeded.
Attached information	Attached Information 1: Error Location Attached Information 3: Names of the Instruction and Instruction Instance Where the Error Occurred. If there is more than one possible instruction, information is given on all of them. Nothing is given if the instruction cannot be identified.				
Precautions/Remarks	If a program is changed after an error occurs, the attached information that is displayed may not be correct.				

Event name	Circular Interpolation Mode Selection Out of Range		Event code	5401542D hex	
Meaning	The parameter specified for the <i>CircMode</i> input variable to a motion control instruction is out of range.				
Source	PLC Function Module		Source details	Instruction	Detection timing At instruction execution
Error attributes	Level	Observation	Recovery	---	Log category System
Effects	User program	Continues.	Operation	The relevant instruction will end according to specifications.	
System-defined variables	Variable		Data type		Name
	_MC_GRP[*].MFAultLvl.Active		BOOL		Axes Group Minor Fault Occurrence
Cause and correction	Assumed cause		Correction		Prevention
	Instruction input parameter exceeded the valid range of the input variable.		Correct the parameter so that the valid range of the input variable is not exceeded for the relevant instruction.		Set the input parameter to the instruction so that the valid range of the input variable is not exceeded.
Attached information	Attached Information 1: Error Location Attached Information 3: Names of the Instruction and Instruction Instance Where the Error Occurred. If there is more than one possible instruction, information is given on all of them. Nothing is given if the instruction cannot be identified.				
Precautions/Remarks	If a program is changed after an error occurs, the attached information that is displayed may not be correct.				

Event name	Direction Selection Out of Range		Event code	5401542E hex		
Meaning	The parameter specified for the <i>Direction</i> input variable to a motion control instruction is out of range.					
Source	PLC Function Module		Source details	Instruction	Detection timing	At instruction execution
Error attributes	Level	Observation	Recovery	---	Log category	System
Effects	User program	Continues.	Operation	The relevant instruction will end according to specifications.		
System-defined variables	Variable		Data type		Name	
	_MC_AX[*].MFAultLvl.Active		BOOL		Axis Minor Fault Occurrence	
Cause and correction	Assumed cause		Correction		Prevention	
	Instruction input parameter exceeded the valid range of the input variable.		Correct the parameter so that the valid range of the input variable is not exceeded for the relevant instruction.		Set the input parameter to the instruction so that the valid range of the input variable is not exceeded.	
Attached information	Attached Information 1: Error Location Attached Information 3: Names of the Instruction and Instruction Instance Where the Error Occurred. If there is more than one possible instruction, information is given on all of them. Nothing is given if the instruction cannot be identified.					
Precautions/Remarks	If a program is changed after an error occurs, the attached information that is displayed may not be correct.					

Event name	Path Selection Out of Range		Event code	5401542F hex		
Meaning	The parameter specified for the <i>PathChoice</i> input variable to a motion control instruction is out of range.					
Source	PLC Function Module		Source details	Instruction	Detection timing	At instruction execution
Error attributes	Level	Observation	Recovery	---	Log category	System
Effects	User program	Continues.	Operation	The relevant instruction will end according to specifications.		
System-defined variables	Variable		Data type		Name	
	_MC_GRP[*].MFAultLvl.Active		BOOL		Axes Group Minor Fault Occurrence	
Cause and correction	Assumed cause		Correction		Prevention	
	Instruction input parameter exceeded the valid range of the input variable.		Correct the parameter so that the valid range of the input variable is not exceeded for the relevant instruction.		Set the input parameter to the instruction so that the valid range of the input variable is not exceeded.	
Attached information	Attached Information 1: Error Location Attached Information 3: Names of the Instruction and Instruction Instance Where the Error Occurred. If there is more than one possible instruction, information is given on all of them. Nothing is given if the instruction cannot be identified.					
Precautions/Remarks	If a program is changed after an error occurs, the attached information that is displayed may not be correct.					

Event name	Position Type Selection Out of Range		Event code	54015430 hex	
Meaning	The parameter specified for the <i>ReferenceType</i> input variable to a motion control instruction is out of range.				
Source	PLC Function Module		Source details	Instruction	Detection timing At instruction execution
Error attributes	Level	Observation	Recovery	---	Log category System
Effects	User program	Continues.	Operation	The relevant instruction will end according to specifications.	
System-defined variables	Variable		Data type		Name
	_MC_COM.MFaultLvl.Active		BOOL		MC Common Minor Fault Occurrence
	_MC_AX[*].MFaultLvl.Active		BOOL		Axis Minor Fault Occurrence
Cause and correction	Assumed cause		Correction		Prevention
	Instruction input parameter exceeded the valid range of the input variable.		Correct the parameter so that the valid range of the input variable is not exceeded for the relevant instruction.		Set the input parameter to the instruction so that the valid range of the input variable is not exceeded.
Attached information	Attached Information 1: Error Location Attached Information 3: Names of the Instruction and Instruction Instance Where the Error Occurred. If there is more than one possible instruction, information is given on all of them. Nothing is given if the instruction cannot be identified.				
Precautions/Remarks	If a program is changed after an error occurs, the attached information that is displayed may not be correct.				

Event name	Travel Mode Selection Out of Range		Event code	54015431 hex	
Meaning	The parameter specified for the <i>MoveMode</i> input variable to a motion control instruction is out of range.				
Source	PLC Function Module		Source details	Instruction	Detection timing At instruction execution
Error attributes	Level	Observation	Recovery	---	Log category System
Effects	User program	Continues.	Operation	The relevant instruction will end according to specifications.	
System-defined variables	Variable		Data type		Name
	_MC_AX[*].MFaultLvl.Active		BOOL		Axis Minor Fault Occurrence
	_MC_GRP[*].MFaultLvl.Active		BOOL		Axes Group Minor Fault Occurrence
Cause and correction	Assumed cause		Correction		Prevention
	Instruction input parameter exceeded the valid range of the input variable.		Correct the parameter so that the valid range of the input variable is not exceeded for the relevant instruction.		Set the input parameter to the instruction so that the valid range of the input variable is not exceeded.
Attached information	Attached Information 1: Error Location Attached Information 3: Names of the Instruction and Instruction Instance Where the Error Occurred. If there is more than one possible instruction, information is given on all of them. Nothing is given if the instruction cannot be identified.				
Precautions/Remarks	If a program is changed after an error occurs, the attached information that is displayed may not be correct.				

Event name	Transition Mode Selection Out of Range		Event code	54015432 hex		
Meaning	The parameter specified for the <i>TransitionMode</i> input variable to a motion control instruction is out of range.					
Source	PLC Function Module		Source details	Instruction	Detection timing	At instruction execution
Error attributes	Level	Observation	Recovery	---	Log category	System
Effects	User program	Continues.	Operation	The relevant instruction will end according to specifications.		
System-defined variables	Variable		Data type		Name	
	_MC_GRP[*].MFaultLvl.Active		BOOL		Axes Group Minor Fault Occurrence	
Cause and correction	Assumed cause		Correction		Prevention	
	Instruction input parameter exceeded the valid range of the input variable.		Correct the parameter so that the valid range of the input variable is not exceeded for the relevant instruction.		Set the input parameter to the instruction so that the valid range of the input variable is not exceeded.	
	_mcAborting or _mcBuffered was specified for BufferMode and _mcTMCornerSuperimposed was specified for TransitionMode .		If you specify _mcAborting or _mcBuffered for BufferMode , specify _mcTMNone for TransitionMode . If you specify _mcTMCornerSuperimposed for TransitionMode , specify _mcBlendingLow, _mcBlendingPrevious, _mcBlendingNext, or _mcBlendingHigh for BufferMode .		If you specify _mcAborting or _mcBuffered for BufferMode , specify _mcTMNone for TransitionMode . If you specify _mcTMCornerSuperimposed for TransitionMode , specify _mcBlendingLow, _mcBlendingPrevious, _mcBlendingNext, or _mcBlendingHigh for BufferMode .	
Attached information	Attached Information 1: Error Location Attached Information 3: Names of the Instruction and Instruction Instance Where the Error Occurred. If there is more than one possible instruction, information is given on all of them. Nothing is given if the instruction cannot be identified.					
Precautions/Remarks	If a program is changed after an error occurs, the attached information that is displayed may not be correct.					

Event name	Continue Method Selection Out of Range		Event code	54015433 hex		
Meaning	The value of the reserved input variable <i>Continuous</i> to a motion control instruction changed.					
Source	PLC Function Module		Source details	Instruction	Detection timing	At instruction execution
Error attributes	Level	Observation	Recovery	---	Log category	System
Effects	User program	Continues.	Operation	The relevant instruction will end according to specifications.		
System-defined variables	Variable		Data type		Name	
	_MC_AX[*].MFaultLvl.Active		BOOL		Axis Minor Fault Occurrence	
Cause and correction	Assumed cause		Correction		Prevention	
	The value of the reserved input variable <i>Continuous</i> changed.		Correct the program so that the value of the reserved input variable <i>Continuous</i> does not change.		Write the user program so that the value of the reserved input variable <i>Continuous</i> does not change.	
Attached information	Attached Information 1: Error Location Attached Information 3: Names of the Instruction and Instruction Instance Where the Error Occurred. If there is more than one possible instruction, information is given on all of them. Nothing is given if the instruction cannot be identified.					
Precautions/Remarks	If a program is changed after an error occurs, the attached information that is displayed may not be correct.					

Event name	Combine Mode Selection Out of Range		Event code	54015434 hex	
Meaning	The parameter specified for the <i>CombineMode</i> input variable to a motion control instruction is out of range.				
Source	PLC Function Module		Source details	Instruction	Detection timing At instruction execution
Error attributes	Level	Observation	Recovery	---	Log category System
Effects	User program	Continues.	Operation	The relevant instruction will end according to specifications.	
System-defined variables	Variable	Data type		Name	
	_MC_AX[*].MFAultLvl.Active	BOOL		Axis Minor Fault Occurrence	
Cause and correction	Assumed cause		Correction		Prevention
	Instruction input parameter exceeded the valid range of the input variable.		Correct the parameter so that the valid range of the input variable is not exceeded for the relevant instruction.		Set the input parameter to the instruction so that the valid range of the input variable is not exceeded.
Attached information	Attached Information 1: Error Location Attached Information 3: Names of the Instruction and Instruction Instance Where the Error Occurred. If there is more than one possible instruction, information is given on all of them. Nothing is given if the instruction cannot be identified.				
Precautions/Remarks	If a program is changed after an error occurs, the attached information that is displayed may not be correct.				

Event name	Synchronization Start Condition Selection Out of Range		Event code	54015435 hex	
Meaning	The parameter specified for the <i>LinkOption</i> input variable to a motion control instruction is out of range.				
Source	PLC Function Module		Source details	Instruction	Detection timing At instruction execution
Error attributes	Level	Observation	Recovery	---	Log category System
Effects	User program	Continues.	Operation	The relevant instruction will end according to specifications.	
System-defined variables	Variable	Data type		Name	
	_MC_AX[*].MFAultLvl.Active	BOOL		Axis Minor Fault Occurrence	
Cause and correction	Assumed cause		Correction		Prevention
	Instruction input parameter exceeded the valid range of the input variable.		Correct the parameter so that the valid range of the input variable is not exceeded for the relevant instruction.		Set the input parameter to the instruction so that the valid range of the input variable is not exceeded.
Attached information	Attached Information 1: Error Location Attached Information 3: Names of the Instruction and Instruction Instance Where the Error Occurred. If there is more than one possible instruction, information is given on all of them. Nothing is given if the instruction cannot be identified.				
Precautions/Remarks	If a program is changed after an error occurs, the attached information that is displayed may not be correct.				

3 Error Descriptions and Corrections

Event name	Master and Slave Defined as Same Axis		Event code	54015436 hex		
Meaning	The same axis is specified for the <i>Master</i> and <i>Slave</i> input variables to a motion control instruction.					
Source	PLC Function Module		Source details	Instruction	Detection timing	At instruction execution
Error attributes	Level	Observation	Recovery	---	Log category	System
Effects	User program	Continues.	Operation	The relevant instruction will end according to specifications.		
System-defined variables	Variable	Data type		Name		
	_MC_COM.MFaultLvl.Active	BOOL		MC Common Minor Fault Occurrence		
	_MC_AX[*].MFaultLvl.Active	BOOL		Axis Minor Fault Occurrence		
Cause and correction	Assumed cause		Correction		Prevention	
	The parameter is the same for the <i>Master</i> and <i>Slave</i> input variables to the instruction.		Correct the parameters so that different axes are specified for the <i>Master</i> and <i>Slave</i> input variables to the instruction.		Specify different axes for the <i>Master</i> and <i>Slave</i> input variables to the instruction.	
Attached information	Attached Information 1: Error Location Attached Information 3: Names of the Instruction and Instruction Instance Where the Error Occurred. If there is more than one possible instruction, information is given on all of them. Nothing is given if the instruction cannot be identified.					
Precautions/Remarks	If a program is changed after an error occurs, the attached information that is displayed may not be correct.					

Event name	Master and Auxiliary Defined as Same Axis		Event code	54015437 hex		
Meaning	The same axis is specified for the <i>Master</i> and <i>Auxiliary</i> input variables to a motion control instruction.					
Source	PLC Function Module		Source details	Instruction	Detection timing	At instruction execution
Error attributes	Level	Observation	Recovery	---	Log category	System
Effects	User program	Continues.	Operation	The relevant instruction will end according to specifications.		
System-defined variables	Variable	Data type		Name		
	_MC_AX[*].MFaultLvl.Active	BOOL		Axis Minor Fault Occurrence		
Cause and correction	Assumed cause		Correction		Prevention	
	The parameter is the same for the <i>Master</i> and <i>Auxiliary</i> input variables to the instruction.		Correct the parameters so that different axes are specified for the <i>Master</i> and <i>Auxiliary</i> input variables to the instruction.		Specify different axes for the <i>Master</i> and <i>Auxiliary</i> input variables to the instruction.	
Attached information	Attached Information 1: Error Location Attached Information 3: Names of the Instruction and Instruction Instance Where the Error Occurred. If there is more than one possible instruction, information is given on all of them. Nothing is given if the instruction cannot be identified.					
Precautions/Remarks	If a program is changed after an error occurs, the attached information that is displayed may not be correct.					

Event name	Master/Slave Axis Numbers Not in Ascending Order		Event code	54015438 hex	
Meaning	The axis numbers specified for the <i>Master</i> and <i>Slave</i> input variables to a motion control instruction are not in ascending order.				
Source	PLC Function Module		Source details	Instruction	Detection timing At instruction execution
Error attributes	Level	Observation	Recovery	---	Log category System
Effects	User program	Continues.	Operation	The relevant instruction will end according to specifications.	
System-defined variables	Variable		Data type		Name
	_MC_AX[*].MFAultLvl.Active		BOOL		Axis Minor Fault Occurrence
Cause and correction	Assumed cause		Correction		Prevention
	The parameters for the <i>Master</i> and <i>Slave</i> input variables to the instruction were not in ascending order when <i>_mcLatestCommand</i> was specified for the <i>ReferenceType</i> input variable to the instruction.		When specifying <i>_mcLatestCommand</i> for the <i>ReferenceType</i> input variable to the instruction, correct the parameters so that the axis numbers specified for the <i>Master</i> and <i>Slave</i> input variables to the instruction are in ascending order. Or, specify <i>_mcCommand</i> for the Master Axis Position Type Selection.		When specifying <i>_mcLatestCommand</i> for the <i>ReferenceType</i> input variable, make sure to specify the master axis and slave axis input variables so that they are in ascending order.
Attached information	Attached Information 1: Error Location Attached Information 3: Names of the Instruction and Instruction Instance Where the Error Occurred. If there is more than one possible instruction, information is given on all of them. Nothing is given if the instruction cannot be identified.				
Precautions/Remarks	If a program is changed after an error occurs, the attached information that is displayed may not be correct.				

Event name	Incorrect Cam Table Specification		Event code	54015439 hex	
Meaning	The parameter specified for the <i>CamTable</i> input variable to a motion control instruction is out of range.				
Source	PLC Function Module		Source details	Instruction	Detection timing At instruction execution
Error attributes	Level	Observation	Recovery	---	Log category System
Effects	User program	Continues.	Operation	The relevant instruction will end according to specifications.	
System-defined variables	Variable		Data type		Name
	_MC_COM.MFAultLvl.Active		BOOL		MC Common Minor Fault Occurrence
Cause and correction	Assumed cause		Correction		Prevention
	Something other than a cam data variable was specified for the <i>CamTable</i> input variable to the instruction.		Correct the parameter specified for the <i>CamTable</i> input variable to the instruction so that it is a cam data variable.		Specify a cam data variable for the <i>CamTable</i> input variable to the instruction.
Attached information	Attached Information 1: Error Location Attached Information 3: Names of the Instruction and Instruction Instance Where the Error Occurred. If there is more than one possible instruction, information is given on all of them. Nothing is given if the instruction cannot be identified.				
Precautions/Remarks	If a program is changed after an error occurs, the attached information that is displayed may not be correct.				

Event name	Synchronization Stopped		Event code	5401543A hex	
Meaning	A synchronized control motion control instruction was executed, but conditions required for execution were not met.				
Source	PLC Function Module		Source details	Instruction	Detection timing At instruction execution
Error attributes	Level	Observation	Recovery	---	Log category System
Effects	User program	Continues.	Operation	The relevant instruction will end according to specifications.	
System-defined variables	Variable	Data type		Name	
	_MC_AX[*].MFaultLvl.Active	BOOL		Axis Minor Fault Occurrence	

Cause and correction	Assumed cause	Correction	Prevention
	<ul style="list-style-type: none"> • The MC_CamOut (End Cam Operation) instruction was executed even though the MC_CamIn (Start Cam Operation) or MC_CamInCurve (Start Cam Operation With Specified Curve) instruction is not being executed. • The MC_GearOut (End Gear Operation) instruction was executed even though the MC_GearIn (Start Gear Operation), MC_GearInPos (Positioning Gear Operation), or MC_GearInPos2 (Positioning Gear Operation2) instruction is not being executed. • The MC_Phasing (Shift Master Axis Phase) instruction was executed even though the MC_CamIn (Start Cam Operation), MC_CamInCurve (Start Cam Operation With Specified Curve), MC_GearIn (Start Gear Operation), MC_GearInPos (Positioning Gear Operation), MC_GearInPos2 (Positioning Gear Operation2), or MC_MoveLink (Synchronous Positioning) instruction is not being executed. (NJ/NX-series)	Correct the program so that required conditions are met when the instruction is executed.	Make sure that required conditions for execution are met when you execute synchronized control instructions.
	<ul style="list-style-type: none"> • The MC_CamOut (End Cam Operation) instruction was executed even though the MC_CamIn (Start Cam Operation) instruction is not being executed. • The MC_GearOut (End Gear Operation) instruction was executed even though the MC_GearIn (Start Gear Operation) or the MC_GearInPos (Positioning Gear Operation) instruction is not being executed. • The MC_Phasing (Shift Master Axis Phase) instruction was executed even though the MC_CamIn (Start Cam Operation), MC_GearIn (Start Gear Operation), MC_GearInPos (Start Gear Operation), or MC_MoveLink (Synchronous Positioning) instruction is not being executed. (NY-series)		

Attached information	Attached Information 1: Error Location Attached Information 3: Names of the Instruction and Instruction Instance Where the Error Occurred. If there is more than one possible instruction, information is given on all of them. Nothing is given if the instruction cannot be identified.
Precautions/Remarks	If a program is changed after an error occurs, the attached information that is displayed may not be correct.

Event name	Motion Control Instruction Re-execution Disabled	Event code	5401543B hex			
Meaning	An attempt was made to re-execute a motion control instruction that cannot be re-executed.					
Source	PLC Function Module	Source details	Instruction	Detection timing	At instruction execution	
Error attributes	Level	Observation	Recovery	---	Log category	System
Effects	User program	Continues.	Operation	The relevant instruction will end according to specifications.		
System-defined variables	Variable	Data type		Name		
	_MC_COM.MFaultLvl.Active	BOOL		MC Common Minor Fault Occurrence		
	_MC_AX[*].MFaultLvl.Active	BOOL		Axis Minor Fault Occurrence		
	_MC_GRP[*].MFaultLvl.Active	BOOL		Axes Group Minor Fault Occurrence		
Cause and correction	Assumed cause	Correction		Prevention		
	A motion control instruction that cannot be re-executed was re-executed.	Correct the program so that the <i>Execute</i> input variable does not change to TRUE until the <i>Busy</i> output variable from the instruction changes to FALSE.		When using instructions that cannot be re-executed, include a condition for the <i>Execute</i> input variable so that it does not change to TRUE unless the <i>Busy</i> output variable for the previous instruction is FALSE. Or, stop the instruction before executing it again.		
Attached information	Attached Information 1: Error Location Attached Information 3: Names of the Instruction and Instruction Instance Where the Error Occurred. If there is more than one possible instruction, information is given on all of them. Nothing is given if the instruction cannot be identified.					
Precautions/Remarks	If a program is changed after an error occurs, the attached information that is displayed may not be correct.					

Event name	Motion Control Instruction Multi-execution Disabled		Event code	5401543C hex	
Meaning	Multiple functions that cannot be executed simultaneously were executed for the same target (MC common, axis, or axes group).				
Source	PLC Function Module		Source details	Instruction	Detection timing At multi-execution of instructions
Error attributes	Level	Observation	Recovery	---	Log category System
Effects	User program	Continues.	Operation	The relevant instruction will end according to specifications.	
System-defined variables	Variable		Data type		Name
	_MC_COM.MFaultLvl.Active		BOOL		MC Common Minor Fault Occurrence
	_MC_AX[*].MFaultLvl.Active		BOOL		Axis Minor Fault Occurrence
System-defined variables	_MC_GRP[*].MFaultLvl.Active		BOOL		Axes Group Minor Fault Occurrence
	Assumed cause	Correction		Prevention	
	Multiple functions that cannot be executed simultaneously were executed for the same target (MC common or axis).	Check the specifications of multi-execution of instructions for this instruction and correct the program so that instructions that cannot be executed at the same time are not executed simultaneously.		Check the specifications for multi-execution of instructions for the instruction and do not execute instructions that cannot be executed at the same time.	
Attached information	Attached Information 1: Error Location Attached Information 3: Names of the Instruction and Instruction Instance Where the Error Occurred. If there is more than one possible instruction, information is given on all of them. Nothing is given if the instruction cannot be identified.				
Precautions/Remarks	If a program is changed after an error occurs, the attached information that is displayed may not be correct.				

Event name	Instruction Not Allowed for Encoder Axis Type		Event code	5401543D hex	
Meaning	An operation instruction was executed for an encoder axis.				
Source	PLC Function Module		Source details	Instruction	Detection timing At instruction execution
Error attributes	Level	Observation	Recovery	---	Log category System
Effects	User program	Continues.	Operation	The relevant instruction will end according to specifications.	
System-defined variables	Variable		Data type		Name
	_MC_AX[*].MFaultLvl.Active		BOOL		Axis Minor Fault Occurrence
Cause and correction	Assumed cause		Correction		Prevention
	An operation instruction was executed for an encoder axis.		Specify either a Servo axis or virtual Servo axis as the axis type for the instruction, or correct the program so that the instruction is not executed for an encoder axis.		Only execute motion instructions for Servo axes or virtual Servo axes.
Attached information	Attached Information 1: Error Location Attached Information 3: Names of the Instruction and Instruction Instance Where the Error Occurred. If there is more than one possible instruction, information is given on all of them. Nothing is given if the instruction cannot be identified.				
Precautions/Remarks	If a program is changed after an error occurs, the attached information that is displayed may not be correct.				

Event name	Instruction Cannot Be Executed during Multi-axes Co-ordinated Control		Event code	5401543E hex		
Meaning	<ul style="list-style-type: none"> An operation instruction was executed for an axis or an axes group that was in a coordinated multi-axes motion. A robot instruction that you cannot use for an axes group in a GroupEnable state was executed. 					
Source	PLC Function Module		Source details	Instruction	Detection timing	At multi-execution of instructions
Error attributes	Level	Observation	Recovery	---	Log category	System
Effects	User program	Continues.	Operation	The relevant instruction will end according to specifications.		
System-defined variables	Variable	Data type		Name		
	_MC_AX[*].MFAultLvl.Active	BOOL		Axis Minor Fault Occurrence		
	_MC_GRP[*].MFAultLvl.Active	BOOL		Axes Group Minor Fault Occurrence		
Cause and correction	Assumed cause	Correction		Prevention		
	An operation instruction was executed for an axis or an axes group that was in a coordinated multi-axes motion.	Correct the program so that axis operation instructions are executed only for axes or axes groups that are not in coordinated multi-axes motion.		Execute axis operation instructions only for axes or axes groups that are not in coordinated multi-axes motion.		
	The MC_SetKinTransform (Set Kinematics Transformation) instruction was executed for an axes group in a GroupEnable state.	Correct the program so that the instruction is executed only when the axes group is in a GroupDisable state.		Execute the instruction only when the axes group is in a GroupDisable state.		
Attached information	Attached Information 1: Error Location Attached Information 3: Names of the Instruction and Instruction Instance Where the Error Occurred. If there is more than one possible instruction, information is given on all of them. Nothing is given if the instruction cannot be identified.					
Precautions/Remarks	If a program is changed after an error occurs, the attached information that is displayed may not be correct.					

Event name	Multi-axes Coordinated Control Instruction Executed for Disabled Axes Group		Event code	5401543F hex	
Meaning	A multi-axes coordinated control instruction was executed for an axes group that was in a GroupDisable state.				
Source	PLC Function Module		Source details	Instruction	Detection timing At instruction execution
Error attributes	Level	Observation	Recovery	---	Log category System
Effects	User program	Continues.	Operation	The relevant instruction will end according to specifications.	
System-defined variables	Variable	Data type		Name	
	_MC_GRP[*].MFAultLvl.Active	BOOL		Axes Group Minor Fault Occurrence	
Cause and correction	Assumed cause	Correction		Prevention	
	A multi-axes coordinated control instruction was executed for an axes group that was in a GroupDisable state.	Correct the program so that the instruction is executed only after changing the axes group to the Axes Group Enabled state. Execute the MC_GroupEnable (Enable Axes Group) instruction to change an axes group to the Axes Group Enabled state.		Execute multi-axes coordinated operation instructions only after enabling the axes group. Execute the MC_GroupEnable (Enable Axes Group) instruction to change an axes group to the Axes Group Enabled state.	
	One of the following instructions was executed for an axes group that was in a GroupDisable state. <ul style="list-style-type: none"> Execute the instruction only when the axes group is in a GroupDisable state. MC_SyncLinearConveyor (Start Conveyor Synchronization) instruction MC_SyncOut (End Synchronization) instruction MC_RobotJog (Axes Group Jog) instruction 				
Attached information	Attached Information 1: Error Location Attached Information 3: Names of the Instruction and Instruction Instance Where the Error Occurred. If there is more than one possible instruction, information is given on all of them. Nothing is given if the instruction cannot be identified.				
Precautions/Remarks	If a program is changed after an error occurs, the attached information that is displayed may not be correct.				

Event name	Axes Group Cannot Be Enabled		Event code	54015440 hex	
Meaning	Execution of the MC_GroupEnable (Enable Axes Group) instruction failed.				
Source	PLC Function Module		Source details	Instruction	Detection timing At instruction execution
Error attributes	Level	Observation	Recovery	---	Log category System
Effects	User program	Continues.	Operation	The relevant instruction will end according to specifications.	
System-defined variables	Variable	Data type		Name	
	_MC_GRP[*].MFaultLvl.Active	BOOL		Axes Group Minor Fault Occurrence	
Cause and correction	Assumed cause	Correction		Prevention	
	When the MC_GroupEnable (Enable Axes Group) instruction was executed, there was a composition axis that was not stopped.	Correct the program so that the MC_GroupEnable (Enable Axes Group) instruction is executed only when all composition axes are stopped. An axis is stopped if <i>Status.Disabled</i> or <i>Status.Standstill</i> is TRUE in the Axis Variable.		Write the programs so that the MC_GroupEnable (Enable Axes Group) instruction is executed only when all composition axes are stopped. An axis is stopped if <i>Status.Disabled</i> or <i>Status.Standstill</i> is TRUE in the Axis Variable.	
	When the MC_GroupEnable (Enable Axes Group) instruction was executed, there was a composition axis for which the MC_TouchProbe (Enable External Latch) instruction was being executed.	Correct the program so that the MC_GroupEnable (Enable Axes Group) instruction is executed only when the MC_TouchProbe (Enable External Latch) instruction is not being executed for any of the composition axes.		Write the program so that the MC_GroupEnable (Enable Axes Group) instruction is executed only when the MC_TouchProbe (Enable External Latch) instruction is not being executed for any of the composition axes.	
Attached information	Attached Information 1: Error Location Attached Information 3: Names of the Instruction and Instruction Instance Where the Error Occurred. If there is more than one possible instruction, information is given on all of them. Nothing is given if the instruction cannot be identified.				
Precautions/Remarks	If a program is changed after an error occurs, the attached information that is displayed may not be correct.				

Event name	Impossible Axis Operation Specified when the Servo is OFF		Event code	54015441 hex	
Meaning	An operation instruction was executed for an axis for which the Servo is OFF.				
Source	PLC Function Module		Source details	Instruction	Detection timing At instruction execution
Error attributes	Level	Observation	Recovery	---	Log category System
Effects	User program	Continues.	Operation	The relevant instruction will end according to specifications.	
System-defined variables	Variable	Data type		Name	
	_MC_AX[*].MFaultLvl.Active	BOOL		Axis Minor Fault Occurrence	
	_MC_GRP[*].MFaultLvl.Active	BOOL		Axes Group Minor Fault Occurrence	
Cause and correction	Assumed cause		Correction		Prevention
	An operation instruction was executed for an axis for which the Servo is OFF.		Correct the program so that the instruction is executed after the Servo is turned ON.		Make sure to execute the axis operation instruction after the Servo is turned ON.
Home was preset with the MC_Home or MC_HomeWithParameter instruction for an axis for which EtherCAT process data communications are not established.		If the <code>_EC_PDSlavTbl</code> (Process Data Communicating Slave Table) systemdefined variable for the EtherCAT master of the master axis is FALSE, remove the cause and execute the MC_Home or MC_HomeWithParameter instruction to preset home after <code>_EC_PDSlavTbl</code> changes to TRUE.		If you execute the MC_Home or MC_HomeWithParameter instruction to preset home immediately after you turn ON the power supply to the Controller, download data, reset a slave communications error, disconnect the slave, reconnect the slave, enable the slave, or disable the slave, write the program to make sure that the <code>_EC_PDSlavTbl</code> (Process Data Communicating Slave Table) systemdefined variable for the EtherCAT master is TRUE before you execute MC_Home or MC_HomeWithParameter.	
Attached information	Attached Information 1: Error Location Attached Information 3: Names of the Instruction and Instruction Instance Where the Error Occurred. If there is more than one possible instruction, information is given on all of them. Nothing is given if the instruction cannot be identified.				
Precautions/Remarks	If a program is changed after an error occurs, the attached information that is displayed may not be correct.				

Event name	Composition Axis Stopped Error		Event code	54015442 hex		
Meaning	A motion instruction was executed for an axes group while the MC_Stop instruction was being executed for a composition axis.					
Source	PLC Function Module		Source details	Instruction	Detection timing	At instruction execution
Error attributes	Level	Observation	Recovery	---	Log category	System
Effects	User program	Continues.	Operation	The relevant instruction will end according to specifications.		
System-defined variables	Variable		Data type		Name	
	_MC_GRP[*].MFaultLvl.Active		BOOL		Axes Group Minor Fault Occurrence	
Cause and correction	Assumed cause		Correction		Prevention	
	A motion instruction was executed for an axes group while the MC_Stop instruction was being executed for a composition axis.		Change the <i>Execute</i> input variable to the MC_Stop instruction for the composition axis to FALSE, reset the error, and then execute the motion control instruction.		Change the <i>Execute</i> input variables to the MC_Stop instructions for all of the composition axes to FALSE before you execute motion control instruction.	
Attached information	Attached Information 1: Error Location Attached Information 3: Names of the Instruction and Instruction Instance Where the Error Occurred. If there is more than one possible instruction, information is given on all of them. Nothing is given if the instruction cannot be identified.					
Precautions/Remarks	If a program is changed after an error occurs, the attached information that is displayed may not be correct.					

Event name	Motion Control Instruction Multi-execution Buffer Limit Exceeded		Event code	54015443 hex		
Meaning	The number of motion control instructions that is buffered for Buffered or Blending Buffer Modes exceeded the buffer limit.					
Source	PLC Function Module		Source details	Instruction	Detection timing	At multi-execution of instructions
Error attributes	Level	Observation	Recovery	---	Log category	System
Effects	User program	Continues.	Operation	The relevant instruction will end according to specifications.		
System-defined variables	Variable		Data type		Name	
	_MC_AX[*].MFaultLvl.Active		BOOL		Axis Minor Fault Occurrence	
	_MC_GRP[*].MFaultLvl.Active		BOOL		Axes Group Minor Fault Occurrence	
Cause and correction	Assumed cause		Correction		Prevention	
	An axis instruction was executed when there was already a current instruction and a buffered instruction for the same axis.		Correct the program so that the number of executed instructions does not exceed the buffer limit.		Do not execute an axis instruction when there is already a current instruction and a buffered instruction for the same axis.	
An axes group instruction was executed when there was already eight current instructions and buffered instructions for the same axis.		Do not execute an axes group instruction when there are already eight current and buffered instructions for the same axis.				
Attached information	Attached Information 1: Error Location Attached Information 3: Names of the Instruction and Instruction Instance Where the Error Occurred. If there is more than one possible instruction, information is given on all of them. Nothing is given if the instruction cannot be identified.					
Precautions/Remarks	If a program is changed after an error occurs, the attached information that is displayed may not be correct.					

Event name	Insufficient Travel Distance		Event code	54015444 hex	
Meaning	The specified motion cannot be executed for the deceleration rate or acceleration rate that was specified for multi-execution or re-execution of a positioning instruction.				
Source	PLC Function Module		Source details	Instruction	Detection timing At instruction execution
Error attributes	Level	Observation	Recovery	---	Log category System
Effects	User program	Continues.	Operation	The relevant instruction will end according to specifications.	
System-defined variables	Variable		Data type	Name	
	_MC_AX[*].MFaultLvl.Active		BOOL	Axis Minor Fault Occurrence	
	_MC_GRP[*].MFaultLvl.Active		BOOL	Axes Group Minor Fault Occurrence	
Cause and correction	Assumed cause		Correction	Prevention	
	Stopping at the target position was not possible for the specified acceleration/deceleration rate for multi-execution or re-execution of a positioning instruction when the Acceleration/Deceleration Over parameter was set to generate a minor fault and stop.		Correct the program based on the operating specifications for the instruction so that the target position is not exceeded at the deceleration rate or acceleration rate specified for multi-execution or re-execution of the positioning instruction. Or, change the Acceleration/Deceleration Over parameter to a setting other than to generate a minor fault and stop.	Check the operating specifications for the relevant instruction and write the program so that this error does not occur. Or, change the Acceleration/Deceleration Over parameter to a setting other than to generate a minor fault and stop.	
Attached information	Attached Information 1: Error Location Attached Information 3: Names of the Instruction and Instruction Instance Where the Error Occurred. If there is more than one possible instruction, information is given on all of them. Nothing is given if the instruction cannot be identified.				
Precautions/Remarks	If a program is changed after an error occurs, the attached information that is displayed may not be correct.				

3 Error Descriptions and Corrections

Event name	Insufficient Travel Distance to Achieve Blending Transit Velocity		Event code	54015445 hex		
Meaning	There is not sufficient travel distance to accelerate or decelerate to the transit velocity.					
Source	PLC Function Module		Source details	Instruction	Detection timing	At multi-execution of instructions
Error attributes	Level	Observation	Recovery	---	Log category	System
Effects	User program	Continues.	Operation	The relevant instruction will end according to specifications.		
System-defined variables	Variable		Data type		Name	
	_MC_AX[*].MFaultLvl.Active		BOOL		Axis Minor Fault Occurrence	
	_MC_GRP[*].MFaultLvl.Active		BOOL		Axes Group Minor Fault Occurrence	
Cause and correction	Assumed cause		Correction		Prevention	
	There was not sufficient travel distance to accelerate the current command to the transit velocity when the Acceleration/Deceleration Over parameter was set to generate a minor fault and stop.		Correct the program to allow a sufficient travel distance according to the operating specifications of the instruction. Or, change the Acceleration/Deceleration Over parameter to a setting other than to generate a minor fault and stop.		Check the operating specifications for the relevant instruction and write the program so that this error does not occur. Or, change the Acceleration/Deceleration Over parameter to a setting other than to generate a minor fault and stop.	
Attached information	Attached Information 1: Error Location Attached Information 3: Names of the Instruction and Instruction Instance Where the Error Occurred. If there is more than one possible instruction, information is given on all of them. Nothing is given if the instruction cannot be identified.					
Precautions/Remarks	If a program is changed after an error occurs, the attached information that is displayed may not be correct.					

Event name	Move Link Constant Velocity Insufficient Travel Distance		Event code	54015446 hex		
Meaning	The constant-velocity travel distance of the master axis is less than zero.					
Source	PLC Function Module		Source details	Instruction	Detection timing	At instruction execution
Error attributes	Level	Observation	Recovery	---	Log category	System
Effects	User program	Continues.	Operation	The relevant instruction will end according to specifications.		
System-defined variables	Variable		Data type		Name	
	_MC_AX[*].MFaultLvl.Active		BOOL		Axis Minor Fault Occurrence	
Cause and correction	Assumed cause		Correction		Prevention	
	The constant velocity travel distance of the master axis is below 0 for the MC_MoveLink (Synchronous Positioning) instruction.		Correct the program so that the master distance is greater than or equal to the master distance in acceleration plus the master distance in deceleration.		Check the operating specifications for the relevant instruction and write the program so that this error does not occur.	
Attached information	Attached Information 1: Error Location Attached Information 3: Names of the Instruction and Instruction Instance Where the Error Occurred. If there is more than one possible instruction, information is given on all of them. Nothing is given if the instruction cannot be identified.					
Precautions/Remarks	If a program is changed after an error occurs, the attached information that is displayed may not be correct.					

Event name	Positioning Gear Operation Insufficient Target Velocity		Event code	54015447 hex		
Meaning	For the MC_GearInPos (Positioning Gear Operation) or MC_GearInPos2 (Positioning Gear Operation2) instruction, the <i>target velocity</i> of the slave axis is too small to achieve the required velocity. (NJ/NX-series) For the MC_GearInPos (Positioning Gear Operation) instruction, the <i>target velocity</i> of the slave axis is too small to achieve the required velocity. (NY-series)					
Source	PLC Function Module		Source details	Instruction	Detection timing	At instruction execution or during instruction execution
Error attributes	Level	Observation	Recovery	---	Log category	System
Effects	User program	Continues.	Operation	The relevant instruction will end according to specifications.		
System-defined variables	Variable	Data type		Name		
	_MC_AX[*].MFAultLvl.Active	BOOL		Axis Minor Fault Occurrence		
Cause and correction	Assumed cause		Correction		Prevention	
	For the MC_GearInPos (Positioning Gear Operation) or MC_GearInPos2 (Positioning Gear Operation2) instruction, the value of the <i>Velocity (Target Velocity)</i> input variable is smaller than the master axis velocity multiplied by the gear ratio when the instruction was executed. (NJ/NX-series)		Set the value of the <i>Velocity (Target Velocity)</i> input variable to a value that is greater than the master axis velocity multiplied by the gear ratio when the instruction is executed based on the operating specifications of the instruction.		Check the operating specifications for the relevant instruction and write the program so that this error does not occur.	
	For the MC_GearInPos (Positioning Gear Operation) instruction, the value of the <i>Velocity (Target Velocity)</i> input variable is smaller than the master axis velocity multiplied by the gear ratio when the instruction was executed. (NY-series)					
Attached information	Attached Information 1: Error Location Attached Information 3: Names of the Instruction and Instruction Instance Where the Error Occurred. If there is more than one possible instruction, information is given on all of them. Nothing is given if the instruction cannot be identified.					
Precautions/Remarks	If a program is changed after an error occurs, the attached information that is displayed may not be correct.					

Event name	Same Start Point and End Point for Circular Interpolation		Event code	54015448 hex		
Meaning	The start point and end point were the same when the radius method was specified for the MC_MoveCircular2D (Circular 2D Interpolation) instruction. Or, the start point, end point, and border point were the same when the border point method was specified.					
Source	PLC Function Module		Source details	Instruction	Detection timing	At instruction execution
Error attributes	Level	Observation	Recovery	---	Log category	System
Effects	User program	Continues.	Operation	The relevant instruction will end according to specifications.		
System-defined variables	Variable	Data type		Name		
	_MC_GRP[*].MFAultLvl.Active	BOOL		Axes Group Minor Fault Occurrence		
Cause and correction	Assumed cause	Correction		Prevention		
	The start point and end point were the same when the radius method was specified for the MC_MoveCircular2D (Circular 2D Interpolation) instruction.	Correct the program so that the radius specification is not used when the start point and end point for the instruction are the same.		Do not use the same start point and end point when you execute circular interpolation with a radius specification.		
	The start point, end point, and border point were the same when the border point method was specified for the MC_MoveCircular2D (Circular 2D Interpolation) instruction.	Correct the program so that border point specification is not used when the start point, end point, and border point for the instruction are the same.		Do not use the same start point, end point, and border point when you execute circular interpolation with a border point specification.		
Attached information	Attached Information 1: Error Location Attached Information 3: Names of the Instruction and Instruction Instance Where the Error Occurred. If there is more than one possible instruction, information is given on all of them. Nothing is given if the instruction cannot be identified.					
Precautions/Remarks	If a program is changed after an error occurs, the attached information that is displayed may not be correct.					

Event name	Circular Interpolation Center Specification Position Out of Range		Event code	54015449 hex		
Meaning	The position specified for the center point exceeded the allowed range when the center method was specified for the MC_MoveCircular2D (Circular 2D Interpolation) instruction.					
Source	PLC Function Module		Source details	Instruction	Detection timing	At instruction execution
Error attributes	Level	Observation	Recovery	---	Log category	System
Effects	User program	Continues.	Operation	The relevant instruction will end according to specifications.		
System-defined variables	Variable	Data type		Name		
	_MC_GRP[*].MFAultLvl.Active	BOOL		Axes Group Minor Fault Occurrence		
Cause and correction	Assumed cause		Correction		Prevention	
	The difference between the distance from the start point to the center point and the distance between the end point to the center point exceeded the permitted value specified for the correction allowance ratio in the axes group settings when the center designation method was specified for the MC_MoveCircular2D (Circular 2D Interpolation) instruction.		Correct the center point so that the difference between the distance from the start point to the center point input variables and the distance between the end point to the center point input variables is less than the permitted value specified for the correction allowance ratio in the axes group settings.		Correct the difference between the distance from the start point to the center point and the distance between the end point to the center point so that it does not exceed the correction allowance ratio in the axes group settings.	
Attached information	Attached Information 1: Error Location Attached Information 3: Names of the Instruction and Instruction Instance Where the Error Occurred. If there is more than one possible instruction, information is given on all of them. Nothing is given if the instruction cannot be identified.					
Precautions/Remarks	If a program is changed after an error occurs, the attached information that is displayed may not be correct.					

Event name	Instruction Execution Error Caused by Count Mode Setting		Event code	5401544A hex		
Meaning	An instruction that cannot be used when the Count Mode is set to Rotary Mode was executed for an axis that was set to Rotary Mode.					
Source	PLC Function Module		Source details	Instruction	Detection timing	At instruction execution
Error attributes	Level	Observation	Recovery	---	Log category	System
Effects	User program	Continues.	Operation	The relevant instruction will end according to specifications.		
System-defined variables	Variable	Data type		Name		
	_MC_GRP[*].MFAultLvl.Active	BOOL		Axes Group Minor Fault Occurrence		
Cause and correction	Assumed cause		Correction		Prevention	
	An instruction that cannot be used when the Count Mode is set to Rotary Mode was executed for an axis that was set to Rotary Mode.		Change the Count Mode of the relevant axis to Linear Mode.		Confirm the Count Mode in which you can execute the instruction and set the correct Count Mode for the axis.	
Attached information	Attached Information 1: Error Location Attached Information 3: Names of the Instruction and Instruction Instance Where the Error Occurred. If there is more than one possible instruction, information is given on all of them. Nothing is given if the instruction cannot be identified.					
Precautions/Remarks	If a program is changed after an error occurs, the attached information that is displayed may not be correct.					

Event name	Parameter Selection Out of Range		Event code	5401544C hex		
Meaning	The parameter specified for the <i>ParameterNumber</i> input variable to a motion control instruction is out of range.					
Source	PLC Function Module		Source details	Instruction	Detection timing	At instruction execution
Error attributes	Level	Observation	Recovery	---	Log category	System
Effects	User program	Continues.	Operation	The relevant instruction will end according to specifications.		
System-defined variables	Variable		Data type		Name	
	_MC_COM.MFaultLvl.Active		BOOL		MC Common Minor Fault Occurrence	
Cause and correction	Assumed cause		Correction		Prevention	
	Instruction input parameter exceeded the valid range of the input variable.		Correct the parameter so that the valid range of the input variable is not exceeded for the relevant instruction.		Set the input parameter to the instruction so that the valid range of the input variable is not exceeded.	
Attached information	Attached Information 1: Error Location Attached Information 3: Names of the Instruction and Instruction Instance Where the Error Occurred. If there is more than one possible instruction, information is given on all of them. Nothing is given if the instruction cannot be identified.					
Precautions/Remarks	If a program is changed after an error occurs, the attached information that is displayed may not be correct.					

Event name	Stop Method Selection Out of Range		Event code	5401544D hex		
Meaning	The parameter specified for the <i>StopMode</i> input variable to a motion control instruction is out of range.					
Source	PLC Function Module		Source details	Instruction	Detection timing	At instruction execution
Error attributes	Level	Observation	Recovery	---	Log category	System
Effects	User program	Continues.	Operation	The relevant instruction will end according to specifications.		
System-defined variables	Variable		Data type		Name	
	_MC_AX[*].MFaultLvl.Active		BOOL		Axis Minor Fault Occurrence	
Cause and correction	Assumed cause		Correction		Prevention	
	Instruction input parameter exceeded the valid range of the input variable.		Correct the parameter so that the valid range of the input variable is not exceeded for the relevant instruction.		Set the input parameter to the instruction so that the valid range of the input variable is not exceeded.	
Attached information	Attached Information 1: Error Location Attached Information 3: Names of the Instruction and Instruction Instance Where the Error Occurred. If there is more than one possible instruction, information is given on all of them. Nothing is given if the instruction cannot be identified.					
Precautions/Remarks	If a program is changed after an error occurs, the attached information that is displayed may not be correct.					

Event name	Latch ID Selection Out of Range for Trigger Input Condition		Event code	5401544E hex		
Meaning	The parameter specified for the <i>TriggerInput::LatchID</i> input variable to a motion control instruction is out of range.					
Source	PLC Function Module		Source details	Instruction	Detection timing	At instruction execution
Error attributes	Level	Observation	Recovery	---	Log category	System
Effects	User program	Continues.	Operation	The relevant instruction will end according to specifications.		
System-defined variables	Variable	Data type		Name		
	_MC_AX[*].MFAultLvl.Active	BOOL		Axis Minor Fault Occurrence		
Cause and correction	Assumed cause		Correction		Prevention	
	Instruction input parameter exceeded the valid range of the input variable.		Correct the parameter so that the valid range of the input variable is not exceeded for the relevant instruction.		Set the input parameter to the instruction so that the valid range of the input variable is not exceeded.	
Attached information	Attached Information 1: Error Location Attached Information 3: Names of the Instruction and Instruction Instance Where the Error Occurred. If there is more than one possible instruction, information is given on all of them. Nothing is given if the instruction cannot be identified.					
Precautions/Remarks	If a program is changed after an error occurs, the attached information that is displayed may not be correct.					

Event name	Setting Out of Range for Writing MC Setting		Event code	5401544F hex		
Meaning	The parameter specified for the <i>SettingValue</i> input variable to a motion control instruction is out of range.					
Source	PLC Function Module		Source details	Instruction	Detection timing	At instruction execution
Error attributes	Level	Observation	Recovery	---	Log category	System
Effects	User program	Continues.	Operation	The relevant instruction will end according to specifications.		
System-defined variables	Variable	Data type		Name		
	_MC_COM.MFAultLvl.Active	BOOL		MC Common Minor Fault Occurrence		
Cause and correction	Assumed cause		Correction		Prevention	
	Instruction input parameter exceeded the valid range of the input variable.		Correct the parameter so that the valid range of the input variable is not exceeded for the relevant instruction.		Set the input parameter to the instruction so that the valid range of the input variable is not exceeded.	
	The parameter specification and the data type of the setting value do not agree.		Make corrections so that the parameter settings and the data types of the settings agree.		Make sure the parameter settings and the data type of the setting values agree.	
Attached information	Attached Information 1: Error Location Attached Information 3: Names of the Instruction and Instruction Instance Where the Error Occurred. If there is more than one possible instruction, information is given on all of them. Nothing is given if the instruction cannot be identified.					
Precautions/Remarks	If a program is changed after an error occurs, the attached information that is displayed may not be correct.					

3 Error Descriptions and Corrections

Event name	Trigger Input Condition Mode Selection Out of Range		Event code	54015450 hex		
Meaning	The parameter specified for the <i>TriggerInput::Mode</i> input variable to a motion control instruction is out of range.					
Source	PLC Function Module		Source details	Instruction	Detection timing	At instruction execution
Error attributes	Level	Observation	Recovery	---	Log category	System
Effects	User program	Continues.	Operation	The relevant instruction will end according to specifications.		
System-defined variables	Variable		Data type		Name	
	_MC_AX[*].MFaultLvl.Active		BOOL		Axis Minor Fault Occurrence	
Cause and correction	Assumed cause		Correction		Prevention	
	Instruction input parameter exceeded the valid range of the input variable.		Correct the parameter so that the valid range of the input variable is not exceeded for the relevant instruction.		Set the input parameter to the instruction so that the valid range of the input variable is not exceeded.	
Attached information	Attached Information 1: Error Location Attached Information 3: Names of the Instruction and Instruction Instance Where the Error Occurred. If there is more than one possible instruction, information is given on all of them. Nothing is given if the instruction cannot be identified.					
Precautions/Remarks	If a program is changed after an error occurs, the attached information that is displayed may not be correct.					

Event name	Drive Trigger Signal Selection Out of Range for Trigger Input Condition		Event code	54015451 hex		
Meaning	The parameter specified for the <i>TriggerInput::InputDrive</i> input variable to a motion control instruction is out of range.					
Source	PLC Function Module		Source details	Instruction	Detection timing	At instruction execution
Error attributes	Level	Observation	Recovery	---	Log category	System
Effects	User program	Continues.	Operation	The relevant instruction will end according to specifications.		
System-defined variables	Variable		Data type		Name	
	_MC_AX[*].MFaultLvl.Active		BOOL		Axis Minor Fault Occurrence	
Cause and correction	Assumed cause		Correction		Prevention	
	Instruction input parameter exceeded the valid range of the input variable.		Correct the parameter so that the valid range of the input variable is not exceeded for the relevant instruction.		Set the input parameter to the instruction so that the valid range of the input variable is not exceeded.	
Attached information	Attached Information 1: Error Location Attached Information 3: Names of the Instruction and Instruction Instance Where the Error Occurred. If there is more than one possible instruction, information is given on all of them. Nothing is given if the instruction cannot be identified.					
Precautions/Remarks	If a program is changed after an error occurs, the attached information that is displayed may not be correct.					

Event name	Motion Control Instruction Re-execution Disabled (Axis Specification)		Event code	54015453 hex		
Meaning	An attempt was made to change the parameter for the Axis input variable when re-executing a motion control instruction. (This input variable cannot be changed when re-executing an instruction.)					
Source	PLC Function Module		Source details	Instruction	Detection timing	At instruction re-execution
Error attributes	Level	Observation	Recovery	---	Log category	System
Effects	User program	Continues.	Operation	The relevant instruction will end according to specifications.		
System-defined variables	Variable	Data type		Name		
	_MC_AX[*].MFaultLvl.Active	BOOL		Axis Minor Fault Occurrence		
Cause and correction	Assumed cause		Correction		Prevention	
	A parameter for an input variable that cannot be changed for re-execution was changed.		Correct the program so that the parameter for the relevant input variable does not change when the relevant instruction is re-executed.		Check the manual to see if the input variables to the relevant motion control instruction can be changed by re-execution. Write the program so that the input parameters for any input variable that cannot be changed do not change upon re-execution.	
Attached information	Attached Information 1: Error Location Attached Information 3: Names of the Instruction and Instruction Instance Where the Error Occurred. If there is more than one possible instruction, information is given on all of them. Nothing is given if the instruction cannot be identified.					
Precautions/Remarks	If a program is changed after an error occurs, the attached information that is displayed may not be correct.					

Event name	Motion Control Instruction Re-execution Disabled (Buffer Mode Selection)		Event code	54015454 hex		
Meaning	An attempt was made to change the parameter for the <i>BufferMode</i> input variable when re-executing a motion control instruction. (This input variable cannot be changed when re-executing an instruction.)					
Source	PLC Function Module		Source details	Instruction	Detection timing	At instruction re-execution
Error attributes	Level	Observation	Recovery	---	Log category	System
Effects	User program	Continues.	Operation	The relevant instruction will end according to specifications.		
System-defined variables	Variable		Data type		Name	
	_MC_AX[*].MFaultLvl.Active		BOOL		Axis Minor Fault Occurrence	
	_MC_GRP[*].MFaultLvl.Active		BOOL		Axes Group Minor Fault Occurrence	
Cause and correction	Assumed cause		Correction		Prevention	
	A parameter for an input variable that cannot be changed for re-execution was changed.		Correct the program so that the parameter for the relevant input variable does not change when the relevant instruction is re-executed.		Check the manual to see if the input variables to the relevant motion control instruction can be changed by re-execution. Write the program so that the input parameters for any input variable that cannot be changed do not change upon re-execution.	
Attached information	Attached Information 1: Error Location Attached Information 3: Names of the Instruction and Instruction Instance Where the Error Occurred. If there is more than one possible instruction, information is given on all of them. Nothing is given if the instruction cannot be identified.					
Precautions/Remarks	If a program is changed after an error occurs, the attached information that is displayed may not be correct.					

Event name	Motion Control Instruction Re-execution Disabled (Direction Selection)		Event code	54015455 hex		
Meaning	An attempt was made to change the parameter for the <i>Direction</i> input variable when re-executing a motion control instruction. (This input variable cannot be changed when re-executing an instruction.)					
Source	PLC Function Module		Source details	Instruction	Detection timing	At instruction re-execution
Error attributes	Level	Observation	Recovery	---	Log category	System
Effects	User program	Continues.	Operation	The relevant instruction will end according to specifications.		
System-defined variables	Variable	Data type		Name		
	_MC_AX[*].MFAultLvl.Active	BOOL		Axis Minor Fault Occurrence		
Cause and correction	Assumed cause		Correction		Prevention	
	An input variable that cannot be changed for re-execution was changed.		Correct the program so that the parameter for the relevant input variable does not change when the relevant instruction is re-executed.		Check the manual to see if the input variables to the relevant motion control instruction can be changed by re-execution. Write the program so that the input parameters for any input variable that cannot be changed do not change upon re-execution.	
Attached information	Attached Information 1: Error Location Attached Information 3: Names of the Instruction and Instruction Instance Where the Error Occurred. If there is more than one possible instruction, information is given on all of them. Nothing is given if the instruction cannot be identified.					
Precautions/Remarks	If a program is changed after an error occurs, the attached information that is displayed may not be correct.					

Event name	Motion Control Instruction Re-execution Disabled (Execution Mode)		Event code	54015456 hex		
Meaning	An attempt was made to change the parameter for the <i>Periodic</i> input variable when re-executing a motion control instruction. (This input variable cannot be changed when re-executing an instruction.)					
Source	PLC Function Module		Source details	Instruction	Detection timing	At instruction re-execution
Error attributes	Level	Observation	Recovery	---	Log category	System
Effects	User program	Continues.	Operation	The relevant instruction will end according to specifications.		
System-defined variables	Variable	Data type		Name		
	_MC_AX[*].MFAultLvl.Active	BOOL		Axis Minor Fault Occurrence		
Cause and correction	Assumed cause		Correction		Prevention	
	A parameter for an input variable that cannot be changed for re-execution was changed.		Correct the program so that the parameter for the relevant input variable does not change when the relevant instruction is re-executed.		Check the manual to see if the input variables to the relevant motion control instruction can be changed by re-execution. Write the program so that the input parameters for any input variable that cannot be changed do not change upon re-execution.	
Attached information	Attached Information 1: Error Location Attached Information 3: Names of the Instruction and Instruction Instance Where the Error Occurred. If there is more than one possible instruction, information is given on all of them. Nothing is given if the instruction cannot be identified.					
Precautions/Remarks	If a program is changed after an error occurs, the attached information that is displayed may not be correct.					

Event name	Motion Control Instruction Re-execution Disabled (Axes Group Specification)		Event code	54015457 hex		
Meaning	An attempt was made to change the parameter for the <i>AxesGroup</i> input variable when re-executing a motion control instruction. (This input variable cannot be changed when re-executing an instruction.)					
Source	PLC Function Module		Source details	Instruction	Detection timing	At instruction re-execution
Error attributes	Level	Observation	Recovery	---	Log category	System
Effects	User program	Continues.	Operation	The relevant instruction will end according to specifications.		
System-defined variables	Variable		Data type		Name	
	_MC_GRP[*].MFAultLvl.Active		BOOL		Axes Group Minor Fault Occurrence	
Cause and correction	Assumed cause		Correction		Prevention	
	A parameter for an input variable that cannot be changed for re-execution was changed.		Correct the program so that the parameter for the relevant input variable does not change when the relevant instruction is re-executed.		Check the manual to see if the input variables to the relevant motion control instruction can be changed by re-execution. Write the program so that the input parameters for any input variable that cannot be changed do not change upon re-execution.	
Attached information	Attached Information 1: Error Location Attached Information 3: Names of the Instruction and Instruction Instance Where the Error Occurred. If there is more than one possible instruction, information is given on all of them. Nothing is given if the instruction cannot be identified.					
Precautions/Remarks	If a program is changed after an error occurs, the attached information that is displayed may not be correct.					

Event name	Motion Control Instruction Re-execution Disabled (Jerk Setting)		Event code	54015458 hex		
Meaning	An attempt was made to change the parameter for the <i>Jerk</i> input variable when re-executing a motion control instruction. (This input variable cannot be changed when re-executing an instruction.)					
Source	PLC Function Module		Source details	Instruction	Detection timing	At instruction re-execution
Error attributes	Level	Observation	Recovery	---	Log category	System
Effects	User program	Continues.	Operation	The relevant instruction will end according to specifications.		
System-defined variables	Variable		Data type	Name		
	_MC_AX[*].MFaultLvl.Active		BOOL	Axis Minor Fault Occurrence		
	_MC_GRP[*].MFaultLvl.Active		BOOL	Axes Group Minor Fault Occurrence		
Cause and correction	Assumed cause		Correction		Prevention	
	A parameter for an input variable that cannot be changed for re-execution was changed.		Correct the program so that the parameter for the relevant input variable does not change when the relevant instruction is re-executed.		Check the manual to see if the input variables to the relevant motion control instruction can be changed by re-execution. Write the program so that the input parameters for any input variable that cannot be changed do not change upon re-execution.	
Attached information	Attached Information 1: Error Location Attached Information 3: Names of the Instruction and Instruction Instance Where the Error Occurred. If there is more than one possible instruction, information is given on all of them. Nothing is given if the instruction cannot be identified.					
Precautions/Remarks	If a program is changed after an error occurs, the attached information that is displayed may not be correct.					

Event name	Motion Control Instruction Re-execution Disabled (Master Axis)		Event code	54015459 hex		
Meaning	An attempt was made to change the parameter for the <i>Master</i> input variable when re-executing a motion control instruction. (This input variable cannot be changed when re-executing an instruction.)					
Source	PLC Function Module		Source details	Instruction	Detection timing	At instruction re-execution
Error attributes	Level	Observation	Recovery	---	Log category	System
Effects	User program	Continues.	Operation	The relevant instruction will end according to specifications.		
System-defined variables	Variable	Data type		Name		
	_MC_AX[*].MFAultLvl.Active	BOOL		Axis Minor Fault Occurrence		
Cause and correction	Assumed cause		Correction		Prevention	
	A parameter for an input variable that cannot be changed for re-execution was changed.		Correct the program so that the parameter for the relevant input variable does not change when the relevant instruction is re-executed.		Check the manual to see if the input variables to the relevant motion control instruction can be changed by re-execution. Write the program so that the input parameters for any input variable that cannot be changed do not change upon re-execution.	
Attached information	Attached Information 1: Error Location Attached Information 3: Names of the Instruction and Instruction Instance Where the Error Occurred. If there is more than one possible instruction, information is given on all of them. Nothing is given if the instruction cannot be identified.					
Precautions/Remarks	If a program is changed after an error occurs, the attached information that is displayed may not be correct.					

Event name	Motion Control Instruction Re-execution Disabled (MasterOffset)		Event code	5401545A hex		
Meaning	An attempt was made to change the parameter for the <i>MasterOffset</i> input variable when re-executing a motion control instruction. (This input variable cannot be changed when re-executing an instruction.)					
Source	PLC Function Module		Source details	Instruction	Detection timing	At instruction re-execution
Error attributes	Level	Observation	Recovery	---	Log category	System
Effects	User program	Continues.	Operation	The relevant instruction will end according to specifications.		
System-defined variables	Variable	Data type		Name		
	_MC_AX[*].MFAultLvl.Active	BOOL		Axis Minor Fault Occurrence		
Cause and correction	Assumed cause		Correction		Prevention	
	A parameter for an input variable that cannot be changed for re-execution was changed.		Correct the program so that the parameter for the relevant input variable does not change when the relevant instruction is re-executed.		Check the manual to see if the input variables to the relevant motion control instruction can be changed by re-execution. Write the program so that the input parameters for any input variable that cannot be changed do not change upon re-execution.	
Attached information	Attached Information 1: Error Location Attached Information 3: Names of the Instruction and Instruction Instance Where the Error Occurred. If there is more than one possible instruction, information is given on all of them. Nothing is given if the instruction cannot be identified.					
Precautions/Remarks	If a program is changed after an error occurs, the attached information that is displayed may not be correct.					

Event name	Motion Control Instruction Re-execution Disabled (MasterScaling)		Event code	5401545B hex		
Meaning	An attempt was made to change the parameter for the <i>MasterScaling</i> input variable when re-executing a motion control instruction. (This input variable cannot be changed when re-executing an instruction.)					
Source	PLC Function Module		Source details	Instruction	Detection timing	At instruction re-execution
Error attributes	Level	Observation	Recovery	---	Log category	System
Effects	User program	Continues.	Operation	The relevant instruction will end according to specifications.		
System-defined variables	Variable	Data type		Name		
	_MC_AX[*].MFAultLvl.Active	BOOL		Axis Minor Fault Occurrence		
Cause and correction	Assumed cause		Correction		Prevention	
	A parameter for an input variable that cannot be changed for re-execution was changed.		Correct the program so that the parameter for the relevant input variable does not change when the relevant instruction is re-executed.		Check the manual to see if the input variables to the relevant motion control instruction can be changed by re-execution. Write the program so that the input parameters for any input variable that cannot be changed do not change upon re-execution.	
Attached information	Attached Information 1: Error Location Attached Information 3: Names of the Instruction and Instruction Instance Where the Error Occurred. If there is more than one possible instruction, information is given on all of them. Nothing is given if the instruction cannot be identified.					
Precautions/Remarks	If a program is changed after an error occurs, the attached information that is displayed may not be correct.					

Event name	Motion Control Instruction Re-execution Disabled (MasterStartDistance)		Event code	5401545C hex		
Meaning	An attempt was made to change the parameter for the <i>MasterStartDistance</i> input variable when re-executing a motion control instruction. (This input variable cannot be changed when re-executing an instruction.)					
Source	PLC Function Module		Source details	Instruction	Detection timing	At instruction re-execution
Error attributes	Level	Observation	Recovery	---	Log category	System
Effects	User program	Continues.	Operation	The relevant instruction will end according to specifications.		
System-defined variables	Variable	Data type		Name		
	_MC_AX[*].MFAultLvl.Active	BOOL		Axis Minor Fault Occurrence		
Cause and correction	Assumed cause		Correction		Prevention	
	A parameter for an input variable that cannot be changed for re-execution was changed.		Correct the program so that the parameter for the relevant input variable does not change when the relevant instruction is re-executed.		Check the manual to see if the input variables to the relevant motion control instruction can be changed by re-execution. Write the program so that the input parameters for any input variable that cannot be changed do not change upon re-execution.	
Attached information	Attached Information 1: Error Location Attached Information 3: Names of the Instruction and Instruction Instance Where the Error Occurred. If there is more than one possible instruction, information is given on all of them. Nothing is given if the instruction cannot be identified.					
Precautions/Remarks	If a program is changed after an error occurs, the attached information that is displayed may not be correct.					

Event name	Motion Control Instruction Re-execution Disabled (Continuous)		Event code	5401545D hex		
Meaning	An attempt was made to change the parameter for the <i>Continuous</i> input variable when re-executing a motion control instruction. (This input variable cannot be changed when re-executing an instruction.)					
Source	PLC Function Module		Source details	Instruction	Detection timing	At instruction re-execution
Error attributes	Level	Observation	Recovery	---	Log category	System
Effects	User program	Continues.	Operation	The relevant instruction will end according to specifications.		
System-defined variables	Variable	Data type		Name		
	_MC_AX[*].MFaultLvl.Active	BOOL		Axis Minor Fault Occurrence		
Cause and correction	Assumed cause		Correction		Prevention	
	A parameter for an input variable that cannot be changed for re-execution was changed.		Correct the program so that the parameter for the relevant input variable does not change when the relevant instruction is re-executed.		Check the manual to see if the input variables to the relevant motion control instruction can be changed by re-execution. Write the program so that the input parameters for any input variable that cannot be changed do not change upon re-execution.	
Attached information	Attached Information 1: Error Location Attached Information 3: Names of the Instruction and Instruction Instance Where the Error Occurred. If there is more than one possible instruction, information is given on all of them. Nothing is given if the instruction cannot be identified.					
Precautions/Remarks	If a program is changed after an error occurs, the attached information that is displayed may not be correct.					

Event name	Motion Control Instruction Re-execution Disabled (MoveMode)		Event code	5401545E hex		
Meaning	An attempt was made to change the parameter for the <i>MoveMode</i> input variable when re-executing a motion control instruction. (This input variable cannot be changed when re-executing an instruction.)					
Source	PLC Function Module		Source details	Instruction	Detection timing	At instruction re-execution
Error attributes	Level	Observation	Recovery	---	Log category	System
Effects	User program	Continues.	Operation	The relevant instruction will end according to specifications.		
System-defined variables	Variable	Data type		Name		
	_MC_AX[*].MFaultLvl.Active	BOOL		Axis Minor Fault Occurrence		
Cause and correction	Assumed cause		Correction		Prevention	
	A parameter for an input variable that cannot be changed for re-execution was changed.		Correct the program so that the parameter for the relevant input variable does not change when the relevant instruction is re-executed.		Check the manual to see if the input variables to the relevant motion control instruction can be changed by re-execution. Write the program so that the input parameters for any input variable that cannot be changed do not change upon re-execution.	
Attached information	Attached Information 1: Error Location Attached Information 3: Names of the Instruction and Instruction Instance Where the Error Occurred. If there is more than one possible instruction, information is given on all of them. Nothing is given if the instruction cannot be identified.					
Precautions/Remarks	If a program is changed after an error occurs, the attached information that is displayed may not be correct.					

Event name	Illegal Auxiliary Axis Specification			Event code	5401545F hex	
Meaning	The axis specified for the <i>Auxiliary</i> input variable to a motion control instruction does not exist.					
Source	PLC Function Module		Source details	Instruction	Detection timing	At instruction execution
Error attributes	Level	Observation	Recovery	---	Log category	System
Effects	User program	Continues.	Operation	The relevant instruction will end according to specifications.		
System-defined variables	Variable		Data type		Name	
	_MC_AX[*].MFAultLvl.Active		BOOL		Axis Minor Fault Occurrence	
Cause and correction	Assumed cause		Correction		Prevention	
	An axis does not exist for the variable specified for the <i>Auxiliary</i> input variable to the instruction.		Correct the instruction so that the variable exists for the axis that was specified for the instruction.		Make sure to specify variables that exist when specifying variables for the input parameters to an instruction.	
Attached information	Attached Information 1: Error Location Attached Information 3: Names of the Instruction and Instruction Instance Where the Error Occurred. If there is more than one possible instruction, information is given on all of them. Nothing is given if the instruction cannot be identified.					
Precautions/Remarks	If a program is changed after an error occurs, the attached information that is displayed may not be correct.					

Event name	Illegal Axis Specification			Event code	54015460 hex	
Meaning	The axis specified for the <i>Axis</i> input variable to a motion control instruction does not exist.					
Source	PLC Function Module		Source details	Instruction	Detection timing	At instruction execution
Error attributes	Level	Observation	Recovery	---	Log category	System
Effects	User program	Continues.	Operation	The relevant instruction will end according to specifications.		
System-defined variables	Variable		Data type		Name	
	_MC_COM.MFAultLvl.Active		BOOL		MC Common Minor Fault Occurrence	
Cause and correction	Assumed cause		Correction		Prevention	
	An axis does not exist for the variable specified for the <i>Axis</i> input variable to the instruction.		Correct the instruction so that the variable exists for the axis that was specified for the instruction.		Make sure to specify variables that exist when specifying variables for the input parameters to an instruction.	
Attached information	Attached Information 1: Error Location Attached Information 3: Names of the Instruction and Instruction Instance Where the Error Occurred. If there is more than one possible instruction, information is given on all of them. Nothing is given if the instruction cannot be identified.					
Precautions/Remarks	If a program is changed after an error occurs, the attached information that is displayed may not be correct.					

Event name	Illegal Axes Group Specification		Event code	54015461 hex	
Meaning	The axes group specified for the <i>AxesGroup</i> input variable to a motion control instruction does not exist or is not a used group.				
Source	PLC Function Module		Source details	Instruction	Detection timing At instruction execution
Error attributes	Level	Observation	Recovery	---	Log category System
Effects	User program	Continues.	Operation	The relevant instruction will end according to specifications.	
System-defined variables	Variable	Data type		Name	
	_MC_COM.MFaultLvl.Active	BOOL		MC Common Minor Fault Occurrence	
Cause and correction	Assumed cause	Correction		Prevention	
	An axes group does not exist for the variable specified for the <i>AxesGroup</i> input variable to the instruction..	Correct the specification for the instruction so that the specified axes group exists.		Specify a variable that exists when specifying a variable for an input parameter to an instruction.	
	The axes group specified for the <i>AxesGroup</i> input variable to the instruction is not specified as a used group.	Correct the axes group specified by the instruction to a used group.		Set a used axes group for the <i>AxesGroup</i> input variable to the instruction.	
Attached information	Attached Information 1: Error Location Attached Information 3: Names of the Instruction and Instruction Instance Where the Error Occurred. If there is more than one possible instruction, information is given on all of them. Nothing is given if the instruction cannot be identified.				
Precautions/Remarks	If a program is changed after an error occurs, the attached information that is displayed may not be correct.				

Event name	Illegal Master Axis Specification		Event code	54015462 hex		
Meaning	The axis that is specified for the <i>Master</i> input variable to a motion control instruction is not correct.					
Source	PLC Function Module	Source details	Instruction	Detection timing	At instruction execution	
Error attributes	Level	Observation	Recovery	---	Log category	System
Effects	User program	Continues.	Operation	The relevant instruction will end according to specifications.		
System-defined variables	Variable	Data type		Name		
	_MC_COM.MFaultLvl.Active	BOOL		MC Common Minor Fault Occurrence		
	_MC_AX[*].MFaultLvl.Active	BOOL		Axis Minor Fault Occurrence		
Cause and correction	Assumed cause	Correction		Prevention		
	An axis does not exist for the variable specified for the <i>Master</i> input variable to the instruction.	Correct the instruction so that the variable exists for the axis that was specified for the instruction.		Specify a variable that exists when specifying a variable for an input parameter to an instruction.		
	The axis that was specified for the <i>Master</i> input variable to the MC_Phasing (Shift Master Axis Phase) instruction is not the master axis for syncing.	Correct the variable that is input to the <i>Master</i> input variable of the MC_Phasing (Shift Master Axis Phase) instruction to the axis variable that is specified as the master axis of the synchronized control instruction.		Correct the variable that is input to the <i>Master</i> input variable of the MC_Phasing (Shift Master Axis Phase) instruction to the axis variable that is specified as the master axis of the synchronized control instruction.		
	The master axis and a slave axis are not assigned to the same task.	Assign the axes that are input to the <i>Master</i> and <i>Slave</i> input variables to the instruction to the same task.		Specify axes that are assigned to the same tasks for the master and slave axes.		
Attached information	Attached Information 1: Error Location Attached Information 3: Names of the Instruction and Instruction Instance Where the Error Occurred. If there is more than one possible instruction, information is given on all of them. Nothing is given if the instruction cannot be identified.					
Precautions/Remarks	If a program is changed after an error occurs, the attached information that is displayed may not be correct.					

Event name	Motion Control Instruction Re-execution Disabled (SlaveOffset)		Event code	54015463 hex		
Meaning	An attempt was made to change the <i>SlaveOffset</i> input variable when re-executing a motion control instruction. (This input variable cannot be changed when re-executing an instruction.)					
Source	PLC Function Module		Source details	Instruction	Detection timing	At instruction re-execution
Error attributes	Level	Observation	Recovery	---	Log category	System
Effects	User program	Continues.	Operation	The relevant instruction will end according to specifications.		
System-defined variables	Variable		Data type		Name	
	_MC_AX[*].MFAultLvl.Active		BOOL		Axis Minor Fault Occurrence	
Cause and correction	Assumed cause		Correction		Prevention	
	A parameter for an input variable that cannot be changed for re-execution was changed.		Correct the program so that the parameter for the relevant input variable does not change when the relevant instruction is re-executed.		Check the manual to see if the input variables to the relevant motion control instruction can be changed by re-execution. Write the program so that the input parameters for any input variable that cannot be changed do not change upon re-execution.	
Attached information	Attached Information 1: Error Location Attached Information 3: Names of the Instruction and Instruction Instance Where the Error Occurred. If there is more than one possible instruction, information is given on all of them. Nothing is given if the instruction cannot be identified.					
Precautions/Remarks	If a program is changed after an error occurs, the attached information that is displayed may not be correct.					

Event name	Motion Control Instruction Re-execution Disabled (SlaveScaling)		Event code	54015464 hex		
Meaning	An attempt was made to change the <i>SlaveScaling</i> input variable when re-executing a motion control instruction. (This input variable cannot be changed when re-executing an instruction.)					
Source	PLC Function Module		Source details	Instruction	Detection timing	At instruction re-execution
Error attributes	Level	Observation	Recovery	---	Log category	System
Effects	User program	Continues.	Operation	The relevant instruction will end according to specifications.		
System-defined variables	Variable		Data type		Name	
	_MC_AX[*].MFAultLvl.Active		BOOL		Axis Minor Fault Occurrence	
Cause and correction	Assumed cause		Correction		Prevention	
	A parameter for an input variable that cannot be changed for re-execution was changed.		Correct the program so that the parameter for the relevant input variable does not change when the relevant instruction is re-executed.		Check the manual to see if the input variables to the relevant motion control instruction can be changed by re-execution. Write the program so that the input parameters for any input variable that cannot be changed do not change upon re-execution.	
Attached information	Attached Information 1: Error Location Attached Information 3: Names of the Instruction and Instruction Instance Where the Error Occurred. If there is more than one possible instruction, information is given on all of them. Nothing is given if the instruction cannot be identified.					
Precautions/Remarks	If a program is changed after an error occurs, the attached information that is displayed may not be correct.					

Event name	Motion Control Instruction Re-execution Disabled (StartPosition)		Event code	54015465 hex		
Meaning	An attempt was made to change the <i>StartPosition</i> input variable when re-executing a motion control instruction. (This input variable cannot be changed when re-executing an instruction.)					
Source	PLC Function Module		Source details	Instruction	Detection timing	At instruction re-execution
Error attributes	Level	Observation	Recovery	---	Log category	System
Effects	User program	Continues.	Operation	The relevant instruction will end according to specifications.		
System-defined variables	Variable	Data type		Name		
	_MC_AX[*].MFAultLvl.Active	BOOL		Axis Minor Fault Occurrence		
Cause and correction	Assumed cause		Correction		Prevention	
	A parameter for an input variable that cannot be changed for re-execution was changed.		Correct the program so that the parameter for the relevant input variable does not change when the relevant instruction is re-executed.		Check the manual to see if the input variables to the relevant motion control instruction can be changed by reexecution. Write the program so that the input parameters for any input variable that cannot be changed do not change upon re-execution.	
Attached information	Attached Information 1: Error Location Attached Information 3: Names of the Instruction and Instruction Instance Where the Error Occurred. If there is more than one possible instruction, information is given on all of them. Nothing is given if the instruction cannot be identified.					
Precautions/Remarks	If a program is changed after an error occurs, the attached information that is displayed may not be correct.					

Event name	Instruction Execution Error with Undefined Home		Event code	54015466 hex	
Meaning	High-speed homing or an interpolation instruction was executed when home was undefined.				
Source	PLC Function Module		Source details	Instruction	Detection timing At instruction execution
Error attributes	Level	Observation	Recovery	---	Log category System
Effects	User program	Continues.	Operation	The relevant instruction will end according to specifications.	
System-defined variables	Variable		Data type		Name
	_MC_AX[*].MFaultLvl.Active		BOOL		Axis Minor Fault Occurrence
	_MC_GRP[*].MFaultLvl.Active		BOOL		Axes Group Minor Fault Occurrence
Cause and correction	Assumed cause		Correction		Prevention
	High-speed homing was executed when home was undefined.		Execute the high-speed homing operation only after homing to define home.		Execute the high-speed homing instruction only after home is defined by homing.
	An interpolation instruction was executed for an axes group that includes an axis with no defined home.		Perform homing to define home for all axes in the axes group before executing the interpolation instruction.		Perform homing to define home for all axes in the axes group before executing the interpolation instruction.
	One of the following robot instructions was executed for an axes group that includes a logical axis with no defined home. <ul style="list-style-type: none"> • MC_SetKinTransform • MC_MoveTimeAbsolute • MC_SyncLinearConveyor • MC_SyncOut • MC_GroupMon • MC_RobotJog 				
Attached information	Attached Information 1: Error Location Attached Information 3: Names of the Instruction and Instruction Instance Where the Error Occurred. If there is more than one possible instruction, information is given on all of them. Nothing is given if the instruction cannot be identified.				
Precautions/Remarks	<ul style="list-style-type: none"> • If a program is changed after an error occurs, the attached information that is displayed may not be correct. • If you execute the Set Position instruction after performing homing, home will again be undefined. You must perform homing again to define home in this case. 				

Event name	Motion Control Instruction Re-execution Disabled (Position Type)		Event code	54015467 hex		
Meaning	An attempt was made to change the <i>ReferenceType</i> input variable when re-executing a motion control instruction. (This input variable cannot be changed when re-executing an instruction.)					
Source	PLC Function Module		Source details	Instruction	Detection timing	At instruction re-execution
Error attributes	Level	Observation	Recovery	---	Log category	System
Effects	User program	Continues.	Operation	The relevant instruction will end according to specifications.		
System-defined variables	Variable	Data type		Name		
	_MC_AX[*].MFAultLvl.Active	BOOL		Axis Minor Fault Occurrence		
Cause and correction	Assumed cause		Correction		Prevention	
	A parameter for an input variable that cannot be changed for re-execution was changed.		Correct the program so that the parameter for the relevant input variable does not change when the relevant instruction is re-executed.		Check the manual to see if the input variables to the relevant motion control instruction can be changed by reexecution. Write the program so that the input parameters for any input variable that cannot be changed do not change upon re-execution.	
Attached information	Attached Information 1: Error Location Attached Information 3: Names of the Instruction and Instruction Instance Where the Error Occurred. If there is more than one possible instruction, information is given on all of them. Nothing is given if the instruction cannot be identified.					
Precautions/Remarks	If a program is changed after an error occurs, the attached information that is displayed may not be correct.					

Event name	Unused Axis Specification for Master Axis		Event code	54015468 hex		
Meaning	The master axis specified for a motion control instruction is an unused axis.					
Source	PLC Function Module		Source details	Instruction	Detection timing	At instruction execution
Error attributes	Level	Observation	Recovery	---	Log category	System
Effects	User program	Continues.	Operation	The relevant instruction will end according to specifications.		
System-defined variables	Variable	Data type		Name		
	_MC_AX[*].MFAultLvl.Active	BOOL		Axis Minor Fault Occurrence		
Cause and correction	Assumed cause		Correction		Prevention	
	The master axis specified for a motion control instruction is an unused axis.		Set a used axis for the master axis that is specified for the instruction.		Make sure the master axis specified for the motion control instruction is a used axis.	
Attached information	Attached Information 1: Error Location Attached Information 3: Names of the Instruction and Instruction Instance Where the Error Occurred. If there is more than one possible instruction, information is given on all of them. Nothing is given if the instruction cannot be identified.					
Precautions/Remarks	If a program is changed after an error occurs, the attached information that is displayed may not be correct.					

3 Error Descriptions and Corrections

Event name	First Position Setting Out of Range		Event code	54015469 hex		
Meaning	The parameter specified for the <i>FirstPosition</i> input variable to a motion control instruction is out of range.					
Source	PLC Function Module		Source details	Instruction	Detection timing	At instruction execution
Error attributes	Level	Observation	Recovery	---	Log category	System
Effects	User program	Continues.	Operation	The relevant instruction will end according to specifications.		
System-defined variables	Variable		Data type		Name	
	_MC_AX[*].MFAultLvl.Active		BOOL		Axis Minor Fault Occurrence	
Cause and correction	Assumed cause		Correction		Prevention	
	Instruction input parameter exceeded the valid range of the input variable.		Correct the parameter so that the valid range of the input variable is not exceeded for the relevant instruction.		Set the input parameter to the instruction so that the valid range of the input variable is not exceeded.	
Attached information	Attached Information 1: Error Location Attached Information 3: Names of the Instruction and Instruction Instance Where the Error Occurred. If there is more than one possible instruction, information is given on all of them. Nothing is given if the instruction cannot be identified.					
Precautions/Remarks	If a program is changed after an error occurs, the attached information that is displayed may not be correct.					

Event name	Last Position Setting Out of Range		Event code	5401546A hex		
Meaning	The parameter specified for the <i>LastPosition</i> input variable to a motion control instruction is out of range.					
Source	PLC Function Module		Source details	Instruction	Detection timing	At instruction execution
Error attributes	Level	Observation	Recovery	---	Log category	System
Effects	User program	Continues.	Operation	The relevant instruction will end according to specifications.		
System-defined variables	Variable		Data type		Name	
	_MC_AX[*].MFAultLvl.Active		BOOL		Axis Minor Fault Occurrence	
Cause and correction	Assumed cause		Correction		Prevention	
	Instruction input parameter exceeded the valid range of the input variable.		Correct the parameter so that the valid range of the input variable is not exceeded for the relevant instruction.		Set the input parameter to the instruction so that the valid range of the input variable is not exceeded.	
Attached information	Attached Information 1: Error Location Attached Information 3: Names of the Instruction and Instruction Instance Where the Error Occurred. If there is more than one possible instruction, information is given on all of them. Nothing is given if the instruction cannot be identified.					
Precautions/Remarks	If a program is changed after an error occurs, the attached information that is displayed may not be correct.					

Event name	Illegal First/Last Position Size Relationship (Linear Mode)		Event code	5401546B hex	
Meaning	The parameter specified for the <i>LastPosition</i> input variable to a motion control instruction is smaller than the parameter specified for the <i>FirstPosition</i> input variable.				
Source	PLC Function Module		Source details	Instruction	Detection timing At instruction execution
Error attributes	Level	Observation	Recovery	---	Log category System
Effects	User program	Continues.	Operation	The relevant instruction will end according to specifications.	
System-defined variables	Variable	Data type		Name	
	_MC_AX[*].MFAultLvl.Active	BOOL		Axis Minor Fault Occurrence	
Cause and correction	Assumed cause	Correction		Prevention	
	The value of the LastPosition input parameter is less than the value of the <i>FirstPosition</i> input variable for the instruction when the Count Mode is set to Linear Mode.	Correct the program so that the value of the LastPosition specified for the instruction is larger than the value of the <i>FirstPosition</i> . Or, change the value of the Count Mode to Rotary Mode.		Write the program so that the value of the LastPosition specified for the instruction is larger than the value of the <i>FirstPosition</i> . Or, check to make sure that the Count Mode of the relevant axis is set to Rotary Mode.	
Attached information	Attached Information 1: Error Location Attached Information 3: Names of the Instruction and Instruction Instance Where the Error Occurred. If there is more than one possible instruction, information is given on all of them. Nothing is given if the instruction cannot be identified.				
Precautions/Remarks	If a program is changed after an error occurs, the attached information that is displayed may not be correct.				

Event name	Master Sync Start Position Setting Out of Range		Event code	5401546C hex	
Meaning	The parameter specified for the <i>MasterSyncPosition</i> input variable to a motion control instruction is out of range.				
Source	PLC Function Module		Source details	Instruction	Detection timing At instruction execution
Error attributes	Level	Observation	Recovery	---	Log category System
Effects	User program	Continues.	Operation	The relevant instruction will end according to specifications.	
System-defined variables	Variable	Data type		Name	
	_MC_AX[*].MFAultLvl.Active	BOOL		Axis Minor Fault Occurrence	
Cause and correction	Assumed cause	Correction		Prevention	
	Instruction input parameter exceeded the valid range of the input variable.	Correct the parameter so that the valid range of the input variable is not exceeded for the relevant instruction.		Set the input parameter to the instruction so that the valid range of the input variable is not exceeded.	
Attached information	Attached Information 1: Error Location Attached Information 3: Names of the Instruction and Instruction Instance Where the Error Occurred. If there is more than one possible instruction, information is given on all of them. Nothing is given if the instruction cannot be identified.				
Precautions/Remarks	If a program is changed after an error occurs, the attached information that is displayed may not be correct.				

Event name	Slave Sync Start Position Setting Out of Range		Event code	5401546D hex	
Meaning	The parameter specified for the <i>SlaveSyncPosition</i> input variable to a motion control instruction is out of range.				
Source	PLC Function Module		Source details	Instruction	Detection timing At instruction execution
Error attributes	Level	Observation	Recovery	---	Log category System
Effects	User program	Continues.	Operation	The relevant instruction will end according to specifications.	
System-defined variables	Variable	Data type		Name	
	_MC_AX[*].MFaultLvl.Active	BOOL		Axis Minor Fault Occurrence	
Cause and correction	Assumed cause		Correction		Prevention
	Instruction input parameter exceeded the valid range of the input variable.		Correct the parameter so that the valid range of the input variable is not exceeded for the relevant instruction.		Set the input parameter to the instruction so that the valid range of the input variable is not exceeded.
Attached information	Attached Information 1: Error Location Attached Information 3: Names of the Instruction and Instruction Instance Where the Error Occurred. If there is more than one possible instruction, information is given on all of them. Nothing is given if the instruction cannot be identified.				
Precautions/Remarks	If a program is changed after an error occurs, the attached information that is displayed may not be correct.				

Event name	Duplicate Latch ID for Trigger Input Condition		Event code	5401546E hex	
Meaning	The same latch ID was specified for more than one motion control instruction.				
Source	PLC Function Module		Source details	Instruction	Detection timing At instruction execution
Error attributes	Level	Observation	Recovery	---	Log category System
Effects	User program	Continues.	Operation	The relevant instruction will end according to specifications.	
System-defined variables	Variable	Data type		Name	
	_MC_AX[*].MFaultLvl.Active	BOOL		Axis Minor Fault Occurrence	
Cause and correction	Assumed cause		Correction		Prevention
	The same latch ID is used simultaneously for more than one of the following instructions: MC_TouchProbe (Enable External Latch) instruction, MC_MoveLink (Synchronous Positioning) instruction, and MC_MoveFeed (Interrupt Feeding) instruction.		Correct the program so that the same latch ID is not used by another instruction at the same time as this instruction. Either use a different latch ID or do not execute any instructions that use the same latch ID at the same time. Both latch 1 and latch 2 are treated as being in use during execution of the MC_Home or MC_HomeWithParameter instruction.		Do not use the same latch ID simultaneously for more than one of the following instructions: MC_TouchProbe (Enable External Latch) instruction, MC_MoveLink (Synchronous Positioning) instruction, and MC_MoveFeed (Interrupt Feeding) instruction.
	The MC_AbortTrigger (Disable External Latch) instruction was executed to cancel a latch that was used by an instruction other than the MC_TouchProbe (Enable External Latch) instruction.		Do not use the Disable External Latch instruction to cancel a latch that is used by an instruction other than the Enable External Latch instruction.		Do not execute the Disable External Latch instruction for a latch that is used by an instruction other than the Enable External Latch instruction.
Attached information	Attached Information 1: Error Location Attached Information 3: Names of the Instruction and Instruction Instance Where the Error Occurred. If there is more than one possible instruction, information is given on all of them. Nothing is given if the instruction cannot be identified.				
Precautions/Remarks	<ul style="list-style-type: none"> If a program is changed after an error occurs, the attached information that is displayed may not be correct. If you decide to change the latch ID, make sure that same latch ID is not used by any other instructions. 				

Event name	Jerk Override Factor Out of Range		Event code	5401546F hex	
Meaning	The parameter specified for the <i>JerkFactor</i> input variable to a motion control instruction is out of range.				
Source	PLC Function Module		Source details	Instruction	Detection timing At instruction execution
Error attributes	Level	Observation	Recovery	---	Log category System
Effects	User program	Continues.	Operation	The relevant instruction will end according to specifications.	
System-defined variables	Variable	Data type		Name	
	_MC_AX[*].MFaultLvl.Active	BOOL		Axis Minor Fault Occurrence	
Cause and correction	Assumed cause		Correction		Prevention
	Instruction input parameter exceeded the valid range of the input variable.		Correct the parameter so that the valid range of the input variable is not exceeded for the relevant instruction.		Set the input parameter to the instruction so that the valid range of the input variable is not exceeded.
Attached information	Attached Information 1: Error Location Attached Information 3: Names of the Instruction and Instruction Instance Where the Error Occurred. If there is more than one possible instruction, information is given on all of them. Nothing is given if the instruction cannot be identified.				
Precautions/Remarks	If a program is changed after an error occurs, the attached information that is displayed may not be correct.				

Event name	Acceleration/Deceleration Override Factor Out of Range		Event code	54015470 hex	
Meaning	The parameter specified for the <i>AccFactor</i> input variable to a motion control instruction is out of range.				
Source	PLC Function Module		Source details	Instruction	Detection timing At instruction execution
Error attributes	Level	Observation	Recovery	---	Log category System
Effects	User program	Continues.	Operation	The relevant instruction will end according to specifications.	
System-defined variables	Variable	Data type		Name	
	_MC_AX[*].MFaultLvl.Active	BOOL		Axis Minor Fault Occurrence	
Cause and correction	Assumed cause		Correction		Prevention
	Instruction input parameter exceeded the valid range of the input variable.		Correct the parameter so that the valid range of the input variable is not exceeded for the relevant instruction.		Set the input parameter to the instruction so that the valid range of the input variable is not exceeded.
Attached information	Attached Information 1: Error Location Attached Information 3: Names of the Instruction and Instruction Instance Where the Error Occurred. If there is more than one possible instruction, information is given on all of them. Nothing is given if the instruction cannot be identified.				
Precautions/Remarks	If a program is changed after an error occurs, the attached information that is displayed may not be correct.				

Event name	First Position Method Specification Out of Range		Event code	54015471 hex		
Meaning	The parameter specified for the <i>StartMode</i> input variable to a motion control instruction is out of range.					
Source	PLC Function Module		Source details	Instruction	Detection timing	At instruction execution
Error attributes	Level	Observation	Recovery	---	Log category	System
Effects	User program	Continues.	Operation	The relevant instruction will end according to specifications.		
System-defined variables	Variable		Data type		Name	
	_MC_AX[*].MFaultLvl.Active		BOOL		Axis Minor Fault Occurrence	
Cause and correction	Assumed cause		Correction		Prevention	
	Instruction input parameter exceeded the valid range of the input variable.		Correct the parameter so that the valid range of the input variable is not exceeded for the relevant instruction.		Set the input parameter to the instruction so that the valid range of the input variable is not exceeded.	
Attached information	Attached Information 1: Error Location Attached Information 3: Names of the Instruction and Instruction Instance Where the Error Occurred. If there is more than one possible instruction, information is given on all of them. Nothing is given if the instruction cannot be identified.					
Precautions/Remarks	If a program is changed after an error occurs, the attached information that is displayed may not be correct.					

Event name	Motion Control Instruction Re-execution Disabled (First Position Method)		Event code	54015472 hex		
Meaning	An attempt was made to change the <i>StartMode</i> input variable when re-executing a motion control instruction. (This input variable cannot be changed when re-executing an instruction.)					
Source	PLC Function Module		Source details	Instruction	Detection timing	At instruction re-execution
Error attributes	Level	Observation	Recovery	---	Log category	System
Effects	User program	Continues.	Operation	The relevant instruction will end according to specifications.		
System-defined variables	Variable		Data type		Name	
	_MC_AX[*].MFaultLvl.Active		BOOL		Axis Minor Fault Occurrence	
Cause and correction	Assumed cause		Correction		Prevention	
	A parameter for an input variable that cannot be changed for re-execution was changed.		Correct the program so that the parameter for the relevant input variable does not change when the relevant instruction is re-executed.		Check the manual to see if the input variables to the relevant motion control instruction can be changed by re-execution. Write the program so that the input parameters for any input variable that cannot be changed do not change upon re-execution.	
Attached information	Attached Information 1: Error Location Attached Information 3: Names of the Instruction and Instruction Instance Where the Error Occurred. If there is more than one possible instruction, information is given on all of them. Nothing is given if the instruction cannot be identified.					
Precautions/Remarks	If a program is changed after an error occurs, the attached information that is displayed may not be correct.					

Event name	Unused Axis Specification for Auxiliary Axis		Event code	54015474 hex	
Meaning	The axis specified for the <i>Auxiliary</i> input variable to a motion control instruction is an unused axis.				
Source	PLC Function Module		Source details	Instruction	Detection timing At instruction execution
Error attributes	Level	Observation	Recovery	---	Log category System
Effects	User program	Continues.	Operation	The relevant instruction will end according to specifications.	
System-defined variables	Variable	Data type		Name	
	_MC_AX[*].MFAultLvl.Active	BOOL		Axis Minor Fault Occurrence	
Cause and correction	Assumed cause	Correction		Prevention	
	The axis specified for the <i>Auxiliary</i> input variable to the instruction is an unused axis.	Set a used axis for the axis that is specified for the instruction. Or, correct the parameter so that it specifies a used axis.		Make sure that the axis specified for the instruction is a used axis.	
Attached information	Attached Information 1: Error Location Attached Information 3: Names of the Instruction and Instruction Instance Where the Error Occurred. If there is more than one possible instruction, information is given on all of them. Nothing is given if the instruction cannot be identified.				
Precautions/Remarks	If a program is changed after an error occurs, the attached information that is displayed may not be correct.				

Event name	Position Gear Value Error		Event code	54015475 hex	
Meaning	Synchronized motion is not possible for the velocity, acceleration rate, and deceleration rate that were input to a motion control instruction.				
Source	PLC Function Module		Source details	Instruction	Detection timing At instruction execution or during instruction execution
Error attributes	Level	Observation	Recovery	---	Log category System
Effects	User program	Continues.	Operation	The relevant instruction will end according to specifications.	
System-defined variables	Variable	Data type		Name	
	_MC_AX[*].MFAultLvl.Active	BOOL		Axis Minor Fault Occurrence	
Cause and correction	Assumed cause	Correction		Prevention	
	The specified synchronized motion cannot be performed at the velocity, acceleration rate, or deceleration rate that is input to the instruction.	Correct the program to enable synchronized motion according to the operating specifications of the MC_GearInPos (Positioning Gear Operation) or MC_GearInPos2 (Positioning Gear Operation2) instruction. (NJ/NX-series)		Check the processing of the relevant instruction and set a value that allows for synchronized motion.	
		Correct the program to enable synchronized motion according to the operating specifications of the MC_GearInPos (Positioning Gear Operation) instruction. (NY-series)			
Attached information	Attached Information 1: Error Location Attached Information 3: Names of the Instruction and Instruction Instance Where the Error Occurred. If there is more than one possible instruction, information is given on all of them. Nothing is given if the instruction cannot be identified.				
Precautions/Remarks	If a program is changed after an error occurs, the attached information that is displayed may not be correct.				

Event name	Position Gear Master Axis Zero Velocity		Event code	54015476 hex		
Meaning	The velocity of the master axis was zero when a motion control instruction was started.					
Source	PLC Function Module		Source details	Instruction	Detection timing	At instruction execution or during instruction execution
Error attributes	Level	Observation	Recovery	---	Log category	System
Effects	User program	Continues.	Operation	The relevant instruction will end according to specifications.		
System-defined variables	Variable		Data type		Name	
	_MC_AX[*].MFAultLvl.Active		BOOL		Axis Minor Fault Occurrence	
Cause and correction	Assumed cause		Correction		Prevention	
	The velocity of the master axis was 0 when the instruction was started.		Correct the program so that the velocity of the master axis is not 0 when the instruction is started.		Write the program so that the velocity of the master axis is not 0 when the instruction is started.	
Attached information	Attached Information 1: Error Location Attached Information 3: Names of the Instruction and Instruction Instance Where the Error Occurred. If there is more than one possible instruction, information is given on all of them. Nothing is given if the instruction cannot be identified.					
Precautions/Remarks	If a program is changed after an error occurs, the attached information that is displayed may not be correct.					

Event name	Target Position Setting Out of Range		Event code	54015478 hex		
Meaning	The parameter specified for the <i>Position</i> input variable to a motion control instruction is out of range.					
Source	PLC Function Module		Source details	Instruction	Detection timing	At instruction execution
Error attributes	Level	Observation	Recovery	---	Log category	System
Effects	User program	Continues.	Operation	The relevant instruction will end according to specifications.		
System-defined variables	Variable		Data type		Name	
	_MC_AX[*].MFAultLvl.Active		BOOL		Axis Minor Fault Occurrence	
	_MC_GRP[*].MFAultLvl.Active		BOOL		Axes Group Minor Fault Occurrence	
Cause and correction	Assumed cause		Correction		Prevention	
	Instruction input parameter exceeded the valid range of the input variable.		Correct the parameter so that the valid range of the input variable is not exceeded for the relevant instruction.		Set the input parameter to the instruction so that the valid range of the input variable is not exceeded.	
	The target position of a Rotary Mode axis is not within the ring setting range.		Correct the target position of the Rotary Mode axis to within the ring setting range.		Set the target position of the Rotary Mode axis to within the ring setting range.	
Attached information	Attached Information 1: Error Location Attached Information 3: Names of the Instruction and Instruction Instance Where the Error Occurred. If there is more than one possible instruction, information is given on all of them. Nothing is given if the instruction cannot be identified.					
Precautions/Remarks	If a program is changed after an error occurs, the attached information that is displayed may not be correct.					

Event name	Travel Distance Out of Range		Event code	54015479 hex	
Meaning	The parameter that was specified for the <i>Distance</i> input variable to a motion control instruction is out of range or the target position with the value of <i>Distance</i> added is out of range.				
Source	PLC Function Module		Source details	Instruction	Detection timing At instruction execution
Error attributes	Level	Observation	Recovery	---	Log category System
Effects	User program	Continues.	Operation	The relevant instruction will end according to specifications.	
System-defined variables	Variable	Data type		Name	
	_MC_AX[*].MFAultLvl.Active	BOOL		Axis Minor Fault Occurrence	
	_MC_GRP[*].MFAultLvl.Active	BOOL		Axes Group Minor Fault Occurrence	
Cause and correction	Assumed cause	Correction		Prevention	
	The absolute value of the instruction input parameter exceeded the range of 40-bit data when it is converted to pulses. For a Linear Mode axis, the target position with the travel distance added exceeded signed 40-bit data when the absolute value is converted to pulses.	Correct the input parameter specified for the <i>Distance</i> input variable of the instruction so that the travel distance and the target position are not out of range.		Write the program so that the travel distance and the target position for the instruction are not out of range.	
Attached information	Attached Information 1: Error Location Attached Information 3: Names of the Instruction and Instruction Instance Where the Error Occurred. If there is more than one possible instruction, information is given on all of them. Nothing is given if the instruction cannot be identified.				
Precautions/Remarks	If a program is changed after an error occurs, the attached information that is displayed may not be correct.				

Event name	Cam Table Start Point Setting Out of Range		Event code	5401547A hex	
Meaning	The parameter specified for the <i>StartPosition</i> input variable to a motion control instruction is out of range.				
Source	PLC Function Module		Source details	Instruction	Detection timing At instruction execution
Error attributes	Level	Observation	Recovery	---	Log category System
Effects	User program	Continues.	Operation	The relevant instruction will end according to specifications.	
System-defined variables	Variable	Data type		Name	
	_MC_AX[*].MFAultLvl.Active	BOOL		Axis Minor Fault Occurrence	
Cause and correction	Assumed cause	Correction		Prevention	
	Instruction input parameter exceeded the valid range of the input variable.	Correct the parameter so that the valid range of the input variable is not exceeded for the relevant instruction.		Set the input parameter to the instruction so that the valid range of the input variable is not exceeded.	
Attached information	Attached Information 1: Error Location Attached Information 3: Names of the Instruction and Instruction Instance Where the Error Occurred. If there is more than one possible instruction, information is given on all of them. Nothing is given if the instruction cannot be identified.				
Precautions/Remarks	If a program is changed after an error occurs, the attached information that is displayed may not be correct.				

Event name	Cam Master Axis Following First Position Setting Out of Range		Event code	5401547B hex		
Meaning	The parameter specified for the <i>MasterStartDistance</i> input variable to a motion control instruction is out of range.					
Source	PLC Function Module		Source details	Instruction	Detection timing	At instruction execution
Error attributes	Level	Observation	Recovery	---	Log category	System
Effects	User program	Continues.	Operation	The relevant instruction will end according to specifications.		
System-defined variables	Variable		Data type		Name	
	_MC_AX[*].MFAultLvl.Active		BOOL		Axis Minor Fault Occurrence	
Cause and correction	Assumed cause		Correction		Prevention	
	Instruction input parameter exceeded the valid range of the input variable.		Correct the parameter so that the valid range of the input variable is not exceeded for the relevant instruction.		Set the input parameter to the instruction so that the valid range of the input variable is not exceeded.	
Attached information	Attached Information 1: Error Location Attached Information 3: Names of the Instruction and Instruction Instance Where the Error Occurred. If there is more than one possible instruction, information is given on all of them. Nothing is given if the instruction cannot be identified.					
Precautions/Remarks	If a program is changed after an error occurs, the attached information that is displayed may not be correct.					

Event name	Circular Interpolation Radius Setting Error		Event code	5401547C hex		
Meaning	It was not possible to create a circular path for the specified radius when the radius method was specified for the MC_MoveCircular2D (Circular 2D Interpolation) instruction.					
Source	PLC Function Module		Source details	Instruction	Detection timing	At instruction execution
Error attributes	Level	Observation	Recovery	---	Log category	System
Effects	User program	Continues.	Operation	The relevant instruction will end according to specifications.		
System-defined variables	Variable		Data type		Name	
	_MC_GRP[*].MFAultLvl.Active		BOOL		Axes Group Minor Fault Occurrence	
Cause and correction	Assumed cause		Correction		Prevention	
	For the MC_MoveCircular2D (Circular 2D Interpolation) instruction, it was not possible to create a circular path for the specified radius when the radius method was specified for circular interpolation.		Correct the radius so that the circular path can be created.		Check the processing of the relevant instruction and set a radius that allows the creation of a circular path.	
Attached information	Attached Information 1: Error Location Attached Information 3: Names of the Instruction and Instruction Instance Where the Error Occurred. If there is more than one possible instruction, information is given on all of them. Nothing is given if the instruction cannot be identified.					
Precautions/Remarks	If a program is changed after an error occurs, the attached information that is displayed may not be correct.					

Event name	Circular Interpolation Radius Overflow		Event code	5401547D hex	
Meaning	For the MC_MoveCircular2D (Circular 2D Interpolation) instruction, the radius of the circle exceeded the maximum value for the border point or center specification method.				
Source	PLC Function Module		Source details	Instruction	Detection timing At instruction execution
Error attributes	Level	Observation	Recovery	---	Log category System
Effects	User program	Continues.	Operation	The relevant instruction will end according to specifications.	
System-defined variables	Variable	Data type		Name	
	_MC_GRP[*].MFaultLvl.Active	BOOL		Axes Group Minor Fault Occurrence	
Cause and correction	Assumed cause	Correction		Prevention	
	For the MC_MoveCircular2D (Circular 2D Interpolation) instruction, the radius of the circle exceeded 40-bit data when it is converted to pulses for the border point or center specification method.	Correct the input parameter so that the circle radius does not exceed 40-bit data when it is converted to pulses based on the operating specifications of the instruction. Border point specification: Start point, border point, and end point Center point specification: Start point, end point, and center point		Check the processing of the instruction and correct the input parameters so that the circle radius does not exceed 40-bit data it is when converted to pulses.	
Attached information	Attached Information 1: Error Location Attached Information 3: Names of the Instruction and Instruction Instance Where the Error Occurred. If there is more than one possible instruction, information is given on all of them. Nothing is given if the instruction cannot be identified.				
Precautions/Remarks	<ul style="list-style-type: none"> • If a program is changed after an error occurs, the attached information that is displayed may not be correct. • If the maximum radius is exceeded when the radius specification method is used, a Border Point/Center Position/Radius Specification Out of Range error occurs. 				

Event name	Circular Interpolation Setting Out of Range		Event code	5401547E hex	
Meaning	The parameter specified for the <i>CircAxes</i> input variable to a motion control instruction is out of range.				
Source	PLC Function Module		Source details	Instruction	Detection timing At instruction execution
Error attributes	Level	Observation	Recovery	---	Log category System
Effects	User program	Continues.	Operation	The relevant instruction will end according to specifications.	
System-defined variables	Variable		Data type		Name
	_MC_GRP[*].MFaultLvl.Active		BOOL		Axes Group Minor Fault Occurrence
Cause and correction	Assumed cause		Correction		Prevention
	Instruction input parameter exceeded the valid range of the input variable.		Correct the parameter so that the valid range of the input variable is not exceeded for the relevant instruction.		Set the input parameters to the instruction so that the valid range of the input variables is not exceeded.
	The axes that were specified in <i>CircAxes</i> are not included in the composition axes in the Axes Group Settings.		Set the axes that are specified for <i>CircAxes</i> so that they are in an axes group configuration.		Make sure that the axes that are specified for <i>CircAxes</i> are in an axes group configuration.
	The same axis was specified for both axes of <i>CircAxes</i> .		Correct the settings so that the two axes specified for <i>CircAxes</i> are different axes.		Write the program so that the two axes specified for <i>CircAxes</i> are different axes.
Attached information	Attached Information 1: Error Location Attached Information 3: Names of the Instruction and Instruction Instance Where the Error Occurred. If there is more than one possible instruction, information is given on all of them. Nothing is given if the instruction cannot be identified.				
Precautions/Remarks	If a program is changed after an error occurs, the attached information that is displayed may not be correct.				

Event name	Auxiliary/Slave Axis Numbers Not in Ascending Order		Event code	5401547F hex	
Meaning	The values of the parameters for the <i>Auxiliary</i> and <i>Slave</i> input variables to a motion control instruction are not in ascending order.				
Source	PLC Function Module		Source details	Instruction	Detection timing At instruction execution
Error attributes	Level	Observation	Recovery	---	Log category System
Effects	User program	Continues.	Operation	The relevant instruction will end according to specifications.	
System-defined variables	Variable		Data type		Name
	_MC_AX[*].MFaultLvl.Active		BOOL		Axis Minor Fault Occurrence
Cause and correction	Assumed cause		Correction		Prevention
	The parameters for the <i>Auxiliary</i> and <i>Slave</i> input variables to the instruction are not in ascending order.		Correct the axis numbers specified for the <i>Auxiliary</i> and <i>Slave</i> input parameters to the instruction so that they are in ascending order.		Write the program so that the axis numbers specified for <i>Auxiliary</i> and <i>Slave</i> are in ascending order.
Attached information	Attached Information 1: Error Location Attached Information 3: Names of the Instruction and Instruction Instance Where the Error Occurred. If there is more than one possible instruction, information is given on all of them. Nothing is given if the instruction cannot be identified.				
Precautions/Remarks	If a program is changed after an error occurs, the attached information that is displayed may not be correct.				

Event name	Cam Table Property Ascending Data Error at Update		Event code	54015480 hex	
Meaning	A phase that was not in ascending order was found during calculating the number of valid data. Or, after calculations, the number of valid data is 0.				
Source	PLC Function Module		Source details	Instruction	Detection timing During instruction execution
Error attributes	Level	Observation	Recovery	---	Log category System
Effects	User program	Continues.	Operation	The relevant instruction will end according to specifications.	
System-defined variables	Variable	Data type		Name	
	_MC_COM.MFaultLvl.Active	BOOL		MC Common Minor Fault Occurrence	
Cause and correction	Assumed cause		Correction		Prevention
	A phase that was not in ascending order was found when calculating the number of valid data.		Place the phase data into ascending order in the cam table data.		Place the phase data into ascending order in the cam table data.
	After calculations, the number of valid data is 0.		Correct the cam table data so that it includes phases that are not 0.		Create the cam table data so that it includes phases that are not 0.
Attached information	Attached Information 1: Error Location Attached Information 3: Names of the Instruction and Instruction Instance Where the Error Occurred. If there is more than one possible instruction, information is given on all of them. Nothing is given if the instruction cannot be identified.				
Precautions/Remarks	If a program is changed after an error occurs, the attached information that is displayed may not be correct.				

Event name	MC_Write Target Out of Range		Event code	54015481 hex	
Meaning	The parameter specified for the <i>Target</i> input variable to a motion control instruction is out of range.				
Source	PLC Function Module		Source details	Instruction	Detection timing At instruction execution
Error attributes	Level	Observation	Recovery	---	Log category System
Effects	User program	Continues.	Operation	The relevant instruction will end according to specifications.	
System-defined variables	Variable	Data type		Name	
	_MC_COM.MFaultLvl.Active	BOOL		MC Common Minor Fault Occurrence	
Cause and correction	Assumed cause		Correction		Prevention
	Instruction input parameter exceeded the valid range of the input variable.		Correct the parameter so that the valid range of the input variable is not exceeded for the relevant instruction.		Set the input parameter to the instruction so that the valid range of the input variable is not exceeded.
Attached information	Attached Information 1: Error Location Attached Information 3: Names of the Instruction and Instruction Instance Where the Error Occurred. If there is more than one possible instruction, information is given on all of them. Nothing is given if the instruction cannot be identified.				
Precautions/Remarks	If a program is changed after an error occurs, the attached information that is displayed may not be correct.				

3 Error Descriptions and Corrections

Event name	Master Travel Distance Specification Out of Range		Event code	54015482 hex		
Meaning	The parameter specified for the <i>MasterDistance</i> input variable to a motion control instruction is out of range.					
Source	PLC Function Module		Source details	Instruction	Detection timing	At instruction execution
Error attributes	Level	Observation	Recovery	---	Log category	System
Effects	User program	Continues.	Operation	The relevant instruction will end according to specifications.		
System-defined variables	Variable		Data type		Name	
	_MC_AX[*].MFAultLvl.Active		BOOL		Axis Minor Fault Occurrence	
Cause and correction	Assumed cause		Correction		Prevention	
	Instruction input parameter exceeded the valid range of the input variable.		Correct the parameter so that the valid range of the input variable is not exceeded for the relevant instruction.		Set the input parameter to the instruction so that the valid range of the input variable is not exceeded.	
Attached information	Attached Information 1: Error Location Attached Information 3: Names of the Instruction and Instruction Instance Where the Error Occurred. If there is more than one possible instruction, information is given on all of them. Nothing is given if the instruction cannot be identified.					
Precautions/Remarks	If a program is changed after an error occurs, the attached information that is displayed may not be correct.					

Event name	Master Distance in Acceleration Specification Out of Range		Event code	54015483 hex		
Meaning	The parameter specified for the <i>MasterDistanceInACC</i> input variable to a motion control instruction is out of range.					
Source	PLC Function Module		Source details	Instruction	Detection timing	At instruction execution
Error attributes	Level	Observation	Recovery	---	Log category	System
Effects	User program	Continues.	Operation	The relevant instruction will end according to specifications.		
System-defined variables	Variable		Data type		Name	
	_MC_AX[*].MFAultLvl.Active		BOOL		Axis Minor Fault Occurrence	
Cause and correction	Assumed cause		Correction		Prevention	
	Instruction input parameter exceeded the valid range of the input variable.		Correct the parameter so that the valid range of the input variable is not exceeded for the relevant instruction.		Set the input parameter to the instruction so that the valid range of the input variable is not exceeded.	
Attached information	Attached Information 1: Error Location Attached Information 3: Names of the Instruction and Instruction Instance Where the Error Occurred. If there is more than one possible instruction, information is given on all of them. Nothing is given if the instruction cannot be identified.					
Precautions/Remarks	If a program is changed after an error occurs, the attached information that is displayed may not be correct.					

Event name	Master Distance in Deceleration Specification Out of Range		Event code	54015484 hex		
Meaning	The parameter specified for the <i>MasterDistanceInDEC</i> input variable to a motion control instruction is out of range.					
Source	PLC Function Module		Source details	Instruction	Detection timing	At instruction execution
Error attributes	Level	Observation	Recovery	---	Log category	System
Effects	User program	Continues.	Operation	The relevant instruction will end according to specifications.		
System-defined variables	Variable	Data type		Name		
	_MC_AX[*].MFAultLvl.Active	BOOL		Axis Minor Fault Occurrence		
Cause and correction	Assumed cause		Correction		Prevention	
	Instruction input parameter exceeded the valid range of the input variable.		Correct the parameter so that the valid range of the input variable is not exceeded for the relevant instruction.		Set the input parameter to the instruction so that the valid range of the input variable is not exceeded.	
Attached information	Attached Information 1: Error Location Attached Information 3: Names of the Instruction and Instruction Instance Where the Error Occurred. If there is more than one possible instruction, information is given on all of them. Nothing is given if the instruction cannot be identified.					
Precautions/Remarks	If a program is changed after an error occurs, the attached information that is displayed may not be correct.					

Event name	Execution Mode Selection Out of Range		Event code	54015487 hex		
Meaning	The parameter specified for the <i>ExecutionMode</i> input variable to a motion control instruction is out of range.					
Source	PLC Function Module		Source details	Instruction	Detection timing	At instruction execution
Error attributes	Level	Observation	Recovery	---	Log category	System
Effects	User program	Continues.	Operation	The relevant instruction will end according to specifications.		
System-defined variables	Variable	Data type		Name		
	_MC_AX[*].MFAultLvl.Active	BOOL		Axis Minor Fault Occurrence		
Cause and correction	Assumed cause		Correction		Prevention	
	Instruction input parameter exceeded the valid range of the input variable.		Correct the parameter so that the valid range of the input variable is not exceeded for the relevant instruction.		Set the input parameter to the instruction so that the valid range of the input variable is not exceeded.	
Attached information	Attached Information 1: Error Location Attached Information 3: Names of the Instruction and Instruction Instance Where the Error Occurred. If there is more than one possible instruction, information is given on all of them. Nothing is given if the instruction cannot be identified.					
Precautions/Remarks	If a program is changed after an error occurs, the attached information that is displayed may not be correct.					

3 Error Descriptions and Corrections

Event name	Permitted Following Error Out of Range		Event code	54015488 hex		
Meaning	The parameter specified for the <i>PermittedDeviation</i> input variable to a motion control instruction is out of range.					
Source	PLC Function Module		Source details	Instruction	Detection timing	At instruction execution
Error attributes	Level	Observation	Recovery	---	Log category	System
Effects	User program	Continues.	Operation	The relevant instruction will end according to specifications.		
System-defined variables	Variable		Data type		Name	
	_MC_COM.MFaultLvl.Active		BOOL		MC Common Minor Fault Occurrence	
Cause and correction	Assumed cause		Correction		Prevention	
	Instruction input parameter exceeded the valid range of the input variable.		Correct the parameter so that the valid range of the input variable is not exceeded for the relevant instruction.		Set the input parameter to the instruction so that the valid range of the input variable is not exceeded.	
Attached information	Attached Information 1: Error Location Attached Information 3: Names of the Instruction and Instruction Instance Where the Error Occurred. If there is more than one possible instruction, information is given on all of them. Nothing is given if the instruction cannot be identified.					
Precautions/Remarks	If a program is changed after an error occurs, the attached information that is displayed may not be correct.					

Event name	Border Point/Center Position/Radius Specification Out of Range		Event code	54015489 hex		
Meaning	The parameter specified for the <i>AuxPoint</i> input variable to a motion control instruction is out of range.					
Source	PLC Function Module		Source details	Instruction	Detection timing	At instruction execution
Error attributes	Level	Observation	Recovery	---	Log category	System
Effects	User program	Continues.	Operation	The relevant instruction will end according to specifications.		
System-defined variables	Variable		Data type		Name	
	_MC_GRP[*].MFaultLvl.Active		BOOL		Axes Group Minor Fault Occurrence	
Cause and correction	Assumed cause		Correction		Prevention	
	The value of <i>AuxPoint</i> exceeded signed 40-bit data when converted to pulses for the border point or center specification method. For a radius specifications, the absolute value of <i>AuxPoint[0]</i> exceeded 40-bit data when it is converted to pulses.		Correct the parameter so that the valid range of the input variable is not exceeded for the relevant instruction.		Set the input parameter to the instruction so that the valid range of the input variable is not exceeded.	
Attached information	Attached Information 1: Error Location Attached Information 3: Names of the Instruction and Instruction Instance Where the Error Occurred. If there is more than one possible instruction, information is given on all of them. Nothing is given if the instruction cannot be identified.					
Precautions/Remarks	If a program is changed after an error occurs, the attached information that is displayed may not be correct.					

Event name	End Point Specification Out of Range		Event code	5401548A hex	
Meaning	The parameter specified for the <i>EndPoint</i> input variable to a motion control instruction is out of range.				
Source	PLC Function Module		Source details	Instruction	Detection timing At instruction execution
Error attributes	Level	Observation	Recovery	---	Log category System
Effects	User program	Continues.	Operation	The relevant instruction will end according to specifications.	
System-defined variables	Variable	Data type		Name	
	_MC_GRP[*].MFaultLvl.Active	BOOL		Axes Group Minor Fault Occurrence	
Cause and correction	Assumed cause		Correction		Prevention
	The instruction input parameter exceeded the range of signed 40-bit data when it was converted to pulses.		Correct the parameter so that the valid range of the input variable is not exceeded for the relevant instruction.		Set the input parameter to the instruction so that the valid range of the input variable is not exceeded.
Attached information	Attached Information 1: Error Location Attached Information 3: Names of the Instruction and Instruction Instance Where the Error Occurred. If there is more than one possible instruction, information is given on all of them. Nothing is given if the instruction cannot be identified.				
Precautions/Remarks	If a program is changed after an error occurs, the attached information that is displayed may not be correct.				

Event name	Slave Travel Distance Specification Out of Range		Event code	5401548B hex	
Meaning	The parameter specified for the <i>SlaveDistance</i> input variable to a motion control instruction is out of range.				
Source	PLC Function Module		Source details	Instruction	Detection timing At instruction execution
Error attributes	Level	Observation	Recovery	---	Log category System
Effects	User program	Continues.	Operation	The relevant instruction will end according to specifications.	
System-defined variables	Variable	Data type		Name	
	_MC_AX[*].MFaultLvl.Active	BOOL		Axis Minor Fault Occurrence	
Cause and correction	Assumed cause		Correction		Prevention
	The instruction input parameter exceeded the range of 40-bit data when it is converted to pulses.		Correct the parameter so that the valid range of the input variable is not exceeded for the relevant instruction.		Set the input parameter to the instruction so that the valid range of the input variable is not exceeded.
Attached information	Attached Information 1: Error Location Attached Information 3: Names of the Instruction and Instruction Instance Where the Error Occurred. If there is more than one possible instruction, information is given on all of them. Nothing is given if the instruction cannot be identified.				
Precautions/Remarks	If a program is changed after an error occurs, the attached information that is displayed may not be correct.				

3 Error Descriptions and Corrections

Event name	Phase Shift Amount Out of Range			Event code	5401548C hex	
Meaning	The parameter specified for the <i>PhaseShift</i> input variable to a motion control instruction is out of range.					
Source	PLC Function Module		Source details	Instruction	Detection timing	At instruction execution
Error attributes	Level	Observation	Recovery	---	Log category	System
Effects	User program	Continues.	Operation	The relevant instruction will end according to specifications.		
System-defined variables	Variable		Data type		Name	
	_MC_AX[*].MFaultLvl.Active		BOOL		Axis Minor Fault Occurrence	
Cause and correction	Assumed cause		Correction		Prevention	
	The absolute value of the instruction input parameter exceeded the range of 40-bit data when it is converted to pulses.		Correct the parameter so that the valid range of the input variable is not exceeded for the relevant instruction.		Set the input parameter to the instruction so that the valid range of the input variable is not exceeded.	
Attached information	Attached Information 1: Error Location Attached Information 3: Names of the Instruction and Instruction Instance Where the Error Occurred. If there is more than one possible instruction, information is given on all of them. Nothing is given if the instruction cannot be identified.					
Precautions/Remarks	If a program is changed after an error occurs, the attached information that is displayed may not be correct.					

Event name	Feeding Distance Out of Range			Event code	5401548D hex	
Meaning	The parameter specified for the <i>FeedDistance</i> input variable to a motion control instruction is out of range.					
Source	PLC Function Module		Source details	Instruction	Detection timing	At instruction execution
Error attributes	Level	Observation	Recovery	---	Log category	System
Effects	User program	Continues.	Operation	The relevant instruction will end according to specifications.		
System-defined variables	Variable		Data type		Name	
	_MC_AX[*].MFaultLvl.Active		BOOL		Axis Minor Fault Occurrence	
Cause and correction	Assumed cause		Correction		Prevention	
	The absolute value of the instruction input parameter exceeded the range of 40-bit data when it is converted to pulses.		Correct the parameter so that the valid range of the input variable is not exceeded for the relevant instruction.		Set the input parameter to the instruction so that the valid range of the input variable is not exceeded.	
Attached information	Attached Information 1: Error Location Attached Information 3: Names of the Instruction and Instruction Instance Where the Error Occurred. If there is more than one possible instruction, information is given on all of them. Nothing is given if the instruction cannot be identified.					
Precautions/Remarks	If a program is changed after an error occurs, the attached information that is displayed may not be correct.					

Event name	Auxiliary and Slave Defined as Same Axis		Event code	5401548E hex	
Meaning	The same axis was specified for the <i>Auxiliary</i> and <i>Slave</i> input variables to a motion control instruction.				
Source	PLC Function Module		Source details	Instruction	Detection timing At instruction execution
Error attributes	Level	Observation	Recovery	---	Log category System
Effects	User program	Continues.	Operation	The relevant instruction will end according to specifications.	
System-defined variables	Variable	Data type		Name	
	_MC_AX[*].MFAultLvl.Active	BOOL		Axis Minor Fault Occurrence	
Cause and correction	Assumed cause		Correction		Prevention
	The parameter was the same for the <i>Auxiliary</i> and <i>Slave</i> input variables to the instruction.		Correct the parameters so that different axes are specified for the <i>Auxiliary</i> and <i>Slave</i> input variables to the instruction.		Specify different axes for the auxiliary axis and slave axis for a motion control instruction.
Attached information	Attached Information 1: Error Location Attached Information 3: Names of the Instruction and Instruction Instance Where the Error Occurred. If there is more than one possible instruction, information is given on all of them. Nothing is given if the instruction cannot be identified.				
Precautions/Remarks	If a program is changed after an error occurs, the attached information that is displayed may not be correct.				

Event name	Relative Position Selection Out of Range		Event code	5401548F hex	
Meaning	The parameter specified for the <i>Relative</i> input variable to a motion control instruction is out of range.				
Source	PLC Function Module		Source details	Instruction	Detection timing At instruction execution
Error attributes	Level	Observation	Recovery	---	Log category System
Effects	User program	Continues.	Operation	The relevant instruction will end according to specifications.	
System-defined variables	Variable	Data type		Name	
	_MC_AX[*].MFAultLvl.Active	BOOL		Axis Minor Fault Occurrence	
Cause and correction	Assumed cause		Correction		Prevention
	Instruction input parameter exceeded the valid range of the input variable.		Correct the parameter so that the valid range of the input variable is not exceeded for the relevant instruction.		Set the input parameter to the instruction so that the valid range of the input variable is not exceeded.
Attached information	Attached Information 1: Error Location Attached Information 3: Names of the Instruction and Instruction Instance Where the Error Occurred. If there is more than one possible instruction, information is given on all of them. Nothing is given if the instruction cannot be identified.				
Precautions/Remarks	If a program is changed after an error occurs, the attached information that is displayed may not be correct.				

3 Error Descriptions and Corrections

Event name	Cam Transition Specification Out of Range		Event code	54015490 hex		
Meaning	The parameter specified for the <i>CamTransition</i> input variable to a motion control instruction is out of range.					
Source	PLC Function Module		Source details	Instruction	Detection timing	At instruction execution
Error attributes	Level	Observation	Recovery	---	Log category	System
Effects	User program	Continues.	Operation	The relevant instruction will end according to specifications.		
System-defined variables	Variable		Data type		Name	
	_MC_AX[*].MFAultLvl.Active		BOOL		Axis Minor Fault Occurrence	
Cause and correction	Assumed cause		Correction		Prevention	
	Instruction input parameter exceeded the valid range of the input variable.		Correct the parameter so that the valid range of the input variable is not exceeded for the relevant instruction.		Set the input parameter to the instruction so that the valid range of the input variable is not exceeded.	
Attached information	Attached Information 1: Error Location Attached Information 3: Names of the Instruction and Instruction Instance Where the Error Occurred. If there is more than one possible instruction, information is given on all of them. Nothing is given if the instruction cannot be identified.					
Precautions/Remarks	If a program is changed after an error occurs, the attached information that is displayed may not be correct.					

Event name	Synchronized Control End Mode Selection Out of Range		Event code	54015491 hex		
Meaning	The parameter specified for the <i>OutMode</i> input variable to a motion control instruction is out of range.					
Source	PLC Function Module		Source details	Instruction	Detection timing	At instruction execution
Error attributes	Level	Observation	Recovery	---	Log category	System
Effects	User program	Continues.	Operation	The relevant instruction will end according to specifications.		
System-defined variables	Variable		Data type		Name	
	_MC_AX[*].MFAultLvl.Active		BOOL		Axis Minor Fault Occurrence	
Cause and correction	Assumed cause		Correction		Prevention	
	Instruction input parameter exceeded the valid range of the input variable.		Correct the parameter so that the valid range of the input variable is not exceeded for the relevant instruction.		Set the input parameter to the instruction so that the valid range of the input variable is not exceeded.	
Attached information	Attached Information 1: Error Location Attached Information 3: Names of the Instruction and Instruction Instance Where the Error Occurred. If there is more than one possible instruction, information is given on all of them. Nothing is given if the instruction cannot be identified.					
Precautions/Remarks	If a program is changed after an error occurs, the attached information that is displayed may not be correct.					

Event name	Enable External Latch Instruction Execution Disabled		Event code	54015492 hex	
Meaning	_mclmediateStop was specified for the StopMode input variable when the MC_TouchProbe (Enable External Latch) instruction was executed in Drive Mode for an encoder axis.				
Source	PLC Function Module		Source details	Instruction	Detection timing At instruction execution
Error attributes	Level	Observation	Recovery	---	Log category System
Effects	User program	Continues.	Operation	The relevant instruction will end according to specifications.	
System-defined variables	Variable	Data type		Name	
	_MC_AX[*].MFAultLvl.Active	BOOL		Axis Minor Fault Occurrence	
Cause and correction	Assumed cause	Correction		Prevention	
	_mclmediateStop was specified for the StopMode input variable when the MC_TouchProbe (Enable External Latch) instruction was executed in Drive Mode for an encoder axis.	Correct the program so that _mclmediateStop is not specified for StopMode for the encoder axis.		If you specify _mclmediateStop and use Drive Mode, execute the MC_TouchProbe (Enable External Latch) instruction only for a servo axis.	
Attached information	Attached Information 1: Error Location Attached Information 3: Names of the Instruction and Instruction Instance Where the Error Occurred. If there is more than one possible instruction, information is given on all of them. Nothing is given if the instruction cannot be identified.				
Precautions/Remarks	If a program is changed after an error occurs, the attached information that is displayed may not be correct.				

Event name	Master Axis Offset Out of Range		Event code	54015493 hex	
Meaning	The parameter specified for the MasterOffset input variable to a motion control instruction is out of range.				
Source	PLC Function Module		Source details	Instruction	Detection timing At instruction execution
Error attributes	Level	Observation	Recovery	---	Log category System
Effects	User program	Continues.	Operation	The relevant instruction will end according to specifications.	
System-defined variables	Variable	Data type		Name	
	_MC_AX[*].MFAultLvl.Active	BOOL		Axis Minor Fault Occurrence	
Cause and correction	Assumed cause	Correction		Prevention	
	The instruction input parameter exceeded the range of signed 40-bit data when it was converted to pulses.	Correct the parameter so that the valid range of the input variable is not exceeded for the relevant instruction.		Set the input parameter to the instruction so that the valid range of the input variable is not exceeded.	
Attached information	Attached Information 1: Error Location Attached Information 3: Names of the Instruction and Instruction Instance Where the Error Occurred. If there is more than one possible instruction, information is given on all of them. Nothing is given if the instruction cannot be identified.				
Precautions/Remarks	If a program is changed after an error occurs, the attached information that is displayed may not be correct.				

3 Error Descriptions and Corrections

Event name	Slave Axis Offset Out of Range		Event code	54015494 hex		
Meaning	The parameter specified for the <i>SlaveOffset</i> input variable to a motion control instruction is out of range.					
Source	PLC Function Module		Source details	Instruction	Detection timing	At instruction execution
Error attributes	Level	Observation	Recovery	---	Log category	System
Effects	User program	Continues.	Operation	The relevant instruction will end according to specifications.		
System-defined variables	Variable		Data type		Name	
	_MC_AX[*].MFaultLvl.Active		BOOL		Axis Minor Fault Occurrence	
Cause and correction	Assumed cause		Correction		Prevention	
	The instruction input parameter exceeded the range of signed 40-bit data when it was converted to pulses.		Correct the parameter so that the valid range of the input variable is not exceeded for the relevant instruction.		Set the input parameter to the instruction so that the valid range of the input variable is not exceeded.	
Attached information	Attached Information 1: Error Location Attached Information 3: Names of the Instruction and Instruction Instance Where the Error Occurred. If there is more than one possible instruction, information is given on all of them. Nothing is given if the instruction cannot be identified.					
Precautions/Remarks	If a program is changed after an error occurs, the attached information that is displayed may not be correct.					

Event name	Command Current Position Count Selection Out of Range		Event code	54015495 hex		
Meaning	The parameter specified for the <i>CmdPosMode</i> input variable to a motion control instruction is out of range.					
Source	PLC Function Module		Source details	Instruction	Detection timing	At instruction execution
Error attributes	Level	Observation	Recovery	---	Log category	System
Effects	User program	Continues.	Operation	The relevant instruction will end according to specifications.		
System-defined variables	Variable		Data type		Name	
	_MC_AX[*].MFaultLvl.Active		BOOL		Axis Minor Fault Occurrence	
Cause and correction	Assumed cause		Correction		Prevention	
	Instruction input parameter exceeded the valid range of the input variable.		Correct the parameter so that the valid range of the input variable is not exceeded for the relevant instruction.		Set the input parameter to the instruction so that the valid range of the input variable is not exceeded.	
Attached information	Attached Information 1: Error Location Attached Information 3: Names of the Instruction and Instruction Instance Where the Error Occurred. If there is more than one possible instruction, information is given on all of them. Nothing is given if the instruction cannot be identified.					
Precautions/Remarks	If a program is changed after an error occurs, the attached information that is displayed may not be correct.					

Event name	Master Axis Gear Ratio Numerator Out of Range		Event code	54015496 hex	
Meaning	The parameter specified for the <i>RatioNumeratorMaster</i> input variable to a motion control instruction is out of range.				
Source	PLC Function Module		Source details	Instruction	Detection timing At instruction execution
Error attributes	Level	Observation	Recovery	---	Log category System
Effects	User program	Continues.	Operation	The relevant instruction will end according to specifications.	
System-defined variables	Variable	Data type		Name	
	_MC_AX[*].MFAultLvl.Active	BOOL		Axis Minor Fault Occurrence	
Cause and correction	Assumed cause		Correction		Prevention
	Instruction input parameter exceeded the valid range of the input variable.		Correct the parameter so that the valid range of the input variable is not exceeded for the relevant instruction.		Set the input parameter to the instruction so that the valid range of the input variable is not exceeded.
Attached information	Attached Information 1: Error Location Attached Information 3: Names of the Instruction and Instruction Instance Where the Error Occurred. If there is more than one possible instruction, information is given on all of them. Nothing is given if the instruction cannot be identified.				
Precautions/Remarks	If a program is changed after an error occurs, the attached information that is displayed may not be correct.				

Event name	Master Axis Gear Ratio Denominator Out of Range		Event code	54015497 hex	
Meaning	The parameter specified for the <i>RatioDenominatorMaster</i> input variable to a motion control instruction is out of range.				
Source	PLC Function Module		Source details	Instruction	Detection timing At instruction execution
Error attributes	Level	Observation	Recovery	---	Log category System
Effects	User program	Continues.	Operation	The relevant instruction will end according to specifications.	
System-defined variables	Variable	Data type		Name	
	_MC_AX[*].MFAultLvl.Active	BOOL		Axis Minor Fault Occurrence	
Cause and correction	Assumed cause		Correction		Prevention
	Instruction input parameter exceeded the valid range of the input variable.		Correct the parameter so that the valid range of the input variable is not exceeded for the relevant instruction.		Set the input parameter to the instruction so that the valid range of the input variable is not exceeded.
Attached information	Attached Information 1: Error Location Attached Information 3: Names of the Instruction and Instruction Instance Where the Error Occurred. If there is more than one possible instruction, information is given on all of them. Nothing is given if the instruction cannot be identified.				
Precautions/Remarks	If a program is changed after an error occurs, the attached information that is displayed may not be correct.				

3 Error Descriptions and Corrections

Event name	Auxiliary Axis Gear Ratio Numerator Out of Range		Event code	54015498 hex		
Meaning	The parameter specified for the <i>RatioNumeratorAuxiliary</i> input variable to a motion control instruction is out of range.					
Source	PLC Function Module		Source details	Instruction	Detection timing	At instruction execution
Error attributes	Level	Observation	Recovery	---	Log category	System
Effects	User program	Continues.	Operation	The relevant instruction will end according to specifications.		
System-defined variables	Variable		Data type		Name	
	_MC_AX[*].MFaultLvl.Active		BOOL		Axis Minor Fault Occurrence	
Cause and correction	Assumed cause		Correction		Prevention	
	Instruction input parameter exceeded the valid range of the input variable.		Correct the parameter so that the valid range of the input variable is not exceeded for the relevant instruction.		Set the input parameter to the instruction so that the valid range of the input variable is not exceeded.	
Attached information	Attached Information 1: Error Location Attached Information 3: Names of the Instruction and Instruction Instance Where the Error Occurred. If there is more than one possible instruction, information is given on all of them. Nothing is given if the instruction cannot be identified.					
Precautions/Remarks	If a program is changed after an error occurs, the attached information that is displayed may not be correct.					

Event name	Auxiliary Axis Gear Ratio Denominator Out of Range		Event code	54015499 hex		
Meaning	The parameter specified for the <i>RatioDenominatorAuxiliary</i> input variable to a motion control instruction is out of range.					
Source	PLC Function Module		Source details	Instruction	Detection timing	At instruction execution
Error attributes	Level	Observation	Recovery	---	Log category	System
Effects	User program	Continues.	Operation	The relevant instruction will end according to specifications.		
System-defined variables	Variable		Data type		Name	
	_MC_AX[*].MFaultLvl.Active		BOOL		Axis Minor Fault Occurrence	
Cause and correction	Assumed cause		Correction		Prevention	
	Instruction input parameter exceeded the valid range of the input variable.		Correct the parameter so that the valid range of the input variable is not exceeded for the relevant instruction.		Set the input parameter to the instruction so that the valid range of the input variable is not exceeded.	
Attached information	Attached Information 1: Error Location Attached Information 3: Names of the Instruction and Instruction Instance Where the Error Occurred. If there is more than one possible instruction, information is given on all of them. Nothing is given if the instruction cannot be identified.					
Precautions/Remarks	If a program is changed after an error occurs, the attached information that is displayed may not be correct.					

Event name	Master Axis Position Type Selection Out of Range		Event code	5401549A hex	
Meaning	The parameter specified for the <i>ReferenceTypeMaster</i> input variable to a motion control instruction is out of range.				
Source	PLC Function Module		Source details	Instruction	Detection timing At instruction execution
Error attributes	Level	Observation	Recovery	---	Log category System
Effects	User program	Continues.	Operation	The relevant instruction will end according to specifications.	
System-defined variables	Variable		Data type		Name
	_MC_AX[*].MFAultLvl.Active		BOOL		Axis Minor Fault Occurrence
Cause and correction	Assumed cause		Correction		Prevention
	Instruction input parameter exceeded the valid range of the input variable.		Correct the parameter so that the valid range of the input variable is not exceeded for the relevant instruction.		Set the input parameter to the instruction so that the valid range of the input variable is not exceeded.
Attached information	Attached Information 1: Error Location Attached Information 3: Names of the Instruction and Instruction Instance Where the Error Occurred. If there is more than one possible instruction, information is given on all of them. Nothing is given if the instruction cannot be identified.				
Precautions/Remarks	If a program is changed after an error occurs, the attached information that is displayed may not be correct.				

Event name	Auxiliary Axis Position Type Selection Out of Range		Event code	5401549B hex	
Meaning	The parameter specified for the <i>ReferenceTypeAuxiliary</i> input variable to a motion control instruction is out of range.				
Source	PLC Function Module		Source details	Instruction	Detection timing At instruction execution
Error attributes	Level	Observation	Recovery	---	Log category System
Effects	User program	Continues.	Operation	The relevant instruction will end according to specifications.	
System-defined variables	Variable		Data type		Name
	_MC_AX[*].MFAultLvl.Active		BOOL		Axis Minor Fault Occurrence
Cause and correction	Assumed cause		Correction		Prevention
	Instruction input parameter exceeded the valid range of the input variable.		Correct the parameter so that the valid range of the input variable is not exceeded for the relevant instruction.		Set the input parameter to the instruction so that the valid range of the input variable is not exceeded.
Attached information	Attached Information 1: Error Location Attached Information 3: Names of the Instruction and Instruction Instance Where the Error Occurred. If there is more than one possible instruction, information is given on all of them. Nothing is given if the instruction cannot be identified.				
Precautions/Remarks	If a program is changed after an error occurs, the attached information that is displayed may not be correct.				

Event name	Target Position Ring Counter Out of Range		Event code	5401549C hex		
Meaning	Operation is not possible because the target position is out of range for the ring counter of the executed instruction.					
Source	PLC Function Module		Source details	Instruction	Detection timing	At instruction execution
Error attributes	Level	Observation	Recovery	---	Log category	System
Effects	User program	Continues.	Operation	The relevant instruction will end according to specifications.		
System-defined variables	Variable		Data type		Name	
	_MC_AX[*].MFAultLvl.Active		BOOL		Axis Minor Fault Occurrence	
Cause and correction	Assumed cause		Correction		Prevention	
	High-speed homing was executed when 0 was not included in the ring counter.		High-speed homing cannot be executed when the ring counter range does not include 0. Correct the program so that high-speed homing is not performed. Or change the settings so that the ring counter range includes 0.		High-speed homing cannot be executed when the ring counter range does not include 0. Write the program so that high-speed homing is not performed. Or make the settings so that the ring counter range includes 0.	
Attached information	Attached Information 1: Error Location Attached Information 3: Names of the Instruction and Instruction Instance Where the Error Occurred. If there is more than one possible instruction, information is given on all of them. Nothing is given if the instruction cannot be identified.					
Precautions/Remarks	If a program is changed after an error occurs, the attached information that is displayed may not be correct.					

Event name	Axes Group Composition Axis Setting Out of Range		Event code	5401549D hex *1		
Meaning	The parameter specified for the Axes input variable to a motion control instruction is out of range.					
Source	PLC Function Module		Source details	Instruction	Detection timing	At instruction execution
Error attributes	Level	Observation	Recovery	---	Log category	System
Effects	User program	Continues.	Operation	The relevant instruction will end according to specifications.		
System-defined variables	Variable		Data type		Name	
	_MC_GRP[*].MFAultLvl.Active		BOOL		Axes Group Minor Fault Occurrence	
Cause and correction	Assumed cause		Correction		Prevention	
	Instruction input parameter exceeded the valid range of the input variable.		Correct the parameter so that the valid range of the input variable is not exceeded for the relevant instruction.		Set the input parameter to the instruction so that the valid range of the input variable is not exceeded.	
	The composition axes in the axes group are not assigned to the same task.		Assign all of the axes that are specified for the Axes input variable to the instruction to the same task.		Specify axes that are assigned to the same task for all of the composition axes in an axes group.	
Attached information	Attached Information 1: Error Location Attached Information 3: Names of the Instruction and Instruction Instance Where the Error Occurred. If there is more than one possible instruction, information is given on all of them. Nothing is given if the instruction cannot be identified.					
Precautions/Remarks	If a program is changed after an error occurs, the attached information that is displayed may not be correct.					

*1. Error code 16#549D occurs for unit version 1.01 or later of the CPU Unit.

Event name	Axis Use Setting Out of Range		Event code	5401549E hex *1	
Meaning	The parameter specified for the <i>AxisUse</i> input variable to a motion control instruction is out of range.				
Source	PLC Function Module		Source details	Instruction	Detection timing At instruction execution
Error attributes	Level	Observation	Recovery	---	Log category System
Effects	User program	Continues.	Operation	The relevant instruction will end according to specifications.	
System-defined variables	Variable	Data type		Name	
	_MC_COM.MFaultLvl.Active	BOOL		MC Common Minor Fault Occurrence	
Cause and correction	Assumed cause	Correction		Prevention	
	Instruction input parameter exceeded the valid range of the input variable.	Correct the parameter so that the valid range of the input variable is not exceeded for the relevant instruction.		Set the input parameter to the instruction so that the valid range of the input variable is not exceeded.	
Attached information	Attached Information 1: Error Location Attached Information 3: Names of the Instruction and Instruction Instance Where the Error Occurred. If there is more than one possible instruction, information is given on all of them. Nothing is given if the instruction cannot be identified.				
Precautions/Remarks	If a program is changed after an error occurs, the attached information that is displayed may not be correct.				

*1. Error code 16#549E occurs for unit version 1.04 or later of the CPU Unit.

Event name	Homing Parameter Setting Out of Range		Event code	54015700 hex *1	
Meaning	The parameter specified for the <i>HomingParameter</i> input variable to a motion control instruction is out of range.				
Source	PLC Function Module		Source details	Instruction	Detection timing At instruction execution
Error attributes	Level	Observation	Recovery	---	Log category System
Effects	User program	Continues.	Operation	The relevant instruction will end according to specifications.	
System-defined variables	Variable	Data type		Name	
	_MC_COM.MFaultLvl.Active	BOOL		MC Common Minor Fault Occurrence	
Cause and correction	Assumed cause	Correction		Prevention	
	Instruction input parameter exceeded the valid range of the input variable.	Correct the parameter so that the valid range of the input variable is not exceeded for the relevant instruction.		Set the input parameter to the instruction so that the valid range of the input variable is not exceeded.	
Attached information	Attached Information 1: Error Location Attached Information 3: Names of the Instruction and Instruction Instance Where the Error Occurred. If there is more than one possible instruction, information is given on all of them. Nothing is given if the instruction cannot be identified.				
Precautions/Remarks	If a program is changed after an error occurs, the attached information that is displayed may not be correct.				

*1. Error code 16#5700 occurs for unit version 1.03 or later of the CPU Unit.

Event name	Axis Use Change Error		Event code	54015702 hex *1	
Meaning	The MC_ChangeAxisUse (Change Axis Use) instruction was executed when the axis was not stopped or when the command velocity of the axis was saturated.				
Source	PLC Function Module		Source details	Instruction	Detection timing At instruction execution
Error attributes	Level	Observation	Recovery	---	Log category System
Effects	User program	Continues.	Operation	The relevant instruction will end according to specifications.	
System-defined variables	Variable	Data type		Name	
	_MC_AX[*].MFAultLvl.Active	BOOL		Axis Minor Fault Occurrence	
Cause and correction	Assumed cause	Correction		Prevention	
	The MC_ChangeAxisUse (Change Axis Use) instruction was executed when the axis was not stopped or when the command velocity of the axis was saturated.	Reset the error and execute the MC_ChangeAxisUse (Change Axis Use) instruction when the axis is stopped or when the command velocity of the axis is not saturated. An axis is stopped if <i>Status.Disabled</i> or <i>Status.Standstill</i> is TRUE in the Axis Variable. The command velocity for an axis is saturated if <i>Details.VelLimit</i> is TRUE in the Axis Variable.		Execute the MC_ChangeAxisUse (Change Axis Use) instruction when the axis is stopped and the command velocity is not saturated.	
Attached information	Attached Information 1: Error Location Attached Information 3: Names of the Instruction and Instruction Instance Where the Error Occurred. If there is more than one possible instruction, information is given on all of them. Nothing is given if the instruction cannot be identified.				
Precautions/Remarks	If a program is changed after an error occurs, the attached information that is displayed may not be correct.				

*1. Error code 16#5702 occurs for unit version 1.04 or later of the CPU Unit.

Event name	Cannot Change Axis Use		Event code	54015703 hex *1	
Meaning	The MC_ChangeAxisUse (Change Axis Use) instruction was executed in a way that would cause the maximum number of used real axes or the maximum number of used motion control servo axes to be exceeded.				
Source	PLC Function Module		Source details	Instruction	Detection timing At instruction execution
Error attributes	Level	Observation	Recovery	---	Log category System
Effects	User program	Continues.	Operation	The relevant instruction will end according to specifications.	
System-defined variables	Variable	Data type		Name	
	_MC_COM.MFaultLvl.Active	BOOL		MC Common Minor Fault Occurrence	
Cause and correction	Assumed cause		Correction		Prevention
	The MC_ChangeAxisUse (Change Axis Use) instruction was executed in a way that would cause the maximum number of actually usable axes to be exceeded.		Correct the program so that the maximum number of axes that can actually be used by the CPU Unit is not exceeded.		Write the program so that the maximum number of axes that can actually be used by the CPU Unit is not exceeded.
	The MC_ChangeAxisUse (Change Axis Use) instruction was executed in a way that would cause the maximum number of used motion control servo axes to be exceeded.		Correct the program so that the maximum number of used motion control servo axes that can be used by the CPU Unit is not exceeded.		Write the program so that the maximum number of used motion control servo axes that can be used by the CPU Unit is not exceeded.
Attached information	Attached Information 1: Error Location Attached Information 3: Names of the Instruction and Instruction Instance Where the Error Occurred. If there is more than one possible instruction, information is given on all of them. Nothing is given if the instruction cannot be identified.				
Precautions/Remarks	If a program is changed after an error occurs, the attached information that is displayed may not be correct.				

*1. Error code 16#5703 occurs for unit version 1.06 or later of the CPU Unit.

Event name	Motion Control Parameter Setting Error When Changing Axis Use		Event code	54015720 hex *1	
Meaning	The motion control parameter settings for the axis that was changed to a used axis are incorrect.				
Source	PLC Function Module		Source details	Instruction	Detection timing At instruction execution
Error attributes	Level	Observation	Recovery	---	Log category System
Effects	User program	Continues.	Operation	The relevant instruction will end according to specifications.	
System-defined variables	Variable		Data type		Name
	_MC_COM.MFaultLvl.Active		BOOL		MC Common Minor Fault Occurrence
Cause and correction	Assumed cause		Correction		Prevention
	The MC_ChangeAxisUse (Change Axis Use) instruction was used to change an unused axis to a used axis, but the motion control parameter settings of the axis are not correct.		Use the Sysmac Studio to change the Axis Use of the axis where the error occurred to a Used Axis , and then check and correct the error location. If an error does not occur, change the setting to an Unused Axis and then download the settings again.		Make sure that operation is correct when the axis is set to a Used Axis and then download the settings with it set to an Unused Axis .
	The power supply was interrupted while a download of the motion control parameter settings was in progress.		Download the MC parameters from the Sysmac Studio.		Do not interrupt the power supply while saving the parameter settings.
	The non-volatile memory is faulty or the life of the non-volatile memory has been exceeded.		If this error remains even after making the above corrections, replace the CPU Unit.		None
Attached information	Attached Information 1: Error Location Attached Information 3: Names of the Instruction and Instruction Instance Where the Error Occurred. If there is more than one possible instruction, information is given on all of them. Nothing is given if the instruction cannot be identified.				
Precautions/Remarks	If a program is changed after an error occurs, the attached information that is displayed may not be correct.				

*1. Error code 16#5720 occurs for unit version 1.04 or later of the CPU Unit.

Event name	Required Process Data Object Not Set When Changing Axis Use		Event code	54015721 hex *1	
Meaning	The objects that are required for the axis type of the axis that was changed to a used axis are not set.				
Source	PLC Function Module		Source details	Instruction	Detection timing At instruction execution
Error attributes	Level	Observation	Recovery	---	Log category System
Effects	User program	Continues.	Operation	The relevant instruction will end according to specifications.	
System-defined variables	Variable	Data type		Name	
	_MC_COM.MFaultLvl.Active	BOOL		MC Common Minor Fault Occurrence	
Cause and correction	Assumed cause	Correction		Prevention	
	The objects that are required for the axis type of the axis that was changed to a used axis are not set in the PDO map settings.	Edit the PDO map settings on the Sysmac Studio and set the objects that are required for the axis where the error occurred. For details on the required objects, refer to the <i>NJ/NX-series Motion Control Instructions Reference Manual (Cat. No. W508)</i> .		Make sure that operation is correct when the axis is set to a Used Axis and then download the settings with it set to an Unused Axis .	
	The power supply was interrupted while a download of the motion control parameter settings was in progress.	Download the MC parameters from the Sysmac Studio.		Do not interrupt the power supply while saving the parameter settings.	
	The non-volatile memory is faulty or the life of the non-volatile memory has been exceeded.	If this error remains even after making the above corrections, replace the CPU Unit.		None	
	The MC_ChangeAxisUse (Change Axis Use) instruction was executed for an axis that Axis Use is set to Unused axis (unchangeable to used axis) .	Correct the program so that the MC_ChangeAxisUse (Change Axis Use) instruction is not executed for an axis that Axis Use is set to Unused axis (unchangeable to used axis) .		Write the program so that the MC_ChangeAxisUse (Change Axis Use) instruction is not executed for an axis that Axis Use is set to Unused axis (unchangeable to used axis) .	
Attached information	Attached Information 1: Error Location Attached Information 3: Names of the Instruction and Instruction Instance Where the Error Occurred. If there is more than one possible instruction, information is given on all of them. Nothing is given if the instruction cannot be identified.				
Precautions/Remarks	If a program is changed after an error occurs, the attached information that is displayed may not be correct.				

*1. Error code 16#5721 occurs for unit version 1.04 or later of the CPU Unit.

Event name	Actual Position Overflow/Underflow		Event code	54015722 hex *1	
Meaning	An instruction was executed that is not supported during an actual position overflow/underflow.				
Source	PLC Function Module		Source details	Instruction	Detection timing At instruction execution
Error attributes	Level	Observation	Recovery	---	Log category System
Effects	User program	Continues.	Operation	The relevant instruction will end according to specifications.	
System-defined variables	Variable	Data type		Name	
	_MC_AX[*].Obsr.Active	BOOL		Axis Observation Occurrence	
Cause and correction	Assumed cause		Correction		Prevention
	An instruction was executed that is not supported during an actual position overflow or underflow.		Execute an error reset and then clear the overflow or underflow state by changing the current position or homing.		Write the program so that overflows and underflows do not occur.
Attached information	Attached Information 1: Error Location Attached Information 3: Names of the Instruction and Instruction Instance Where the Error Occurred. If there is more than one possible instruction, information is given on all of them. Nothing is given if the instruction cannot be identified.				
Precautions/Remarks	If a program is changed after an error occurs, the attached information that is displayed may not be correct.				

*1. Error code 16#5722 occurs for unit version 1.06 or later of the CPU Unit.

Event name	Switch Structure Track Number Setting Out of Range		Event code	54015723 hex *1	
Meaning	The value of <i>TrackNumber</i> that is specified in the <i>Switches</i> in-out variable to a motion control instruction is out of range.				
Source	PLC Function Module		Source details	Instruction	Detection timing At instruction execution
Error attributes	Level	Observation	Recovery	---	Log category System
Effects	User program	Continues.	Operation	The relevant instruction will end according to specifications.	
System-defined variables	Variable	Data type		Name	
	_MC_AX[*].Obsr.Active	BOOL		Axis Observation Occurrence	
Cause and correction	Assumed cause		Correction		Prevention
	The value of the member of the structure variable that was specified for the in-out variable of the instruction is out of range.		Correct the value of the member of the structure variable that is specified for the in-out variable of the relevant instruction so that it is in the valid range.		Make sure that the value of the member of the structure variable that is specified for the in-out variable of the relevant instruction is in the valid range.
Attached information	Attached Information 1: Error Location Attached Information 3: Names of the Instruction and Instruction Instance Where the Error Occurred. If there is more than one possible instruction, information is given on all of them. Nothing is given if the instruction cannot be identified.				
Precautions/Remarks	If a program is changed after an error occurs, the attached information that is displayed may not be correct.				

*1. Error code 16#5723 occurs for unit version 1.06 or later of the CPU Unit.

Event name	Switch Structure First ON Position Setting Out of Range		Event code	54015724 hex *1		
Meaning	The value of <i>FirstOnPosition</i> that is specified in the <i>Switches</i> in-out variable to a motion control instruction is out of range.					
Source	PLC Function Module		Source details	Instruction	Detection timing	At instruction execution
Error attributes	Level	Observation	Recovery	---	Log category	System
Effects	User program	Continues.	Operation	The relevant instruction will end according to specifications.		
System-defined variables	Variable	Data type		Name		
	_MC_AX[*].Obsr.Active	BOOL		Axis Observation Occurrence		
Cause and correction	Assumed cause		Correction		Prevention	
	The value of the member of the structure variable that was specified for the in-out variable of the instruction is out of range.		Correct the value of the member of the structure variable that is specified for the in-out variable of the relevant instruction so that it is in the valid range.		Make sure that the value of the member of the structure variable that is specified for the in-out variable of the relevant instruction is in the valid range.	
Attached information	Attached Information 1: Error Location Attached Information 3: Names of the Instruction and Instruction Instance Where the Error Occurred. If there is more than one possible instruction, information is given on all of them. Nothing is given if the instruction cannot be identified.					
Precautions/Remarks	If a program is changed after an error occurs, the attached information that is displayed may not be correct.					

*1. Error code 16#5724 occurs for unit version 1.06 or later of the CPU Unit.

Event name	Switch Structure Last ON Position Setting Out of Range		Event code	54015725 hex *1		
Meaning	The value of <i>LastOnPosition</i> that is specified in the <i>Switches</i> in-out variable to a motion control instruction is out of range.					
Source	PLC Function Module		Source details	Instruction	Detection timing	At instruction execution
Error attributes	Level	Observation	Recovery	---	Log category	System
Effects	User program	Continues.	Operation	The relevant instruction will end according to specifications.		
System-defined variables	Variable	Data type		Name		
	_MC_AX[*].Obsr.Active	BOOL		Axis Observation Occurrence		
Cause and correction	Assumed cause		Correction		Prevention	
	The value of the member of the structure variable that was specified for the in-out variable of the instruction is out of range.		Correct the value of the member of the structure variable that is specified for the in-out variable of the relevant instruction so that it is in the valid range.		Make sure that the value of the member of the structure variable that is specified for the in-out variable of the relevant instruction is in the valid range.	
Attached information	Attached Information 1: Error Location Attached Information 3: Names of the Instruction and Instruction Instance Where the Error Occurred. If there is more than one possible instruction, information is given on all of them. Nothing is given if the instruction cannot be identified.					
Precautions/Remarks	If a program is changed after an error occurs, the attached information that is displayed may not be correct.					

*1. Error code 16#5725 occurs for unit version 1.06 or later of the CPU Unit.

Event name	Switch Structure Axis Direction Out of Range		Event code	54015726 hex *1		
Meaning	The value of <i>AxisDirection</i> that is specified in the <i>Switches</i> in-out variable to a motion control instruction is out of range.					
Source	PLC Function Module		Source details	Instruction	Detection timing	At instruction execution
Error attributes	Level	Observation	Recovery	---	Log category	System
Effects	User program	Continues.	Operation	The relevant instruction will end according to specifications.		
System-defined variables	Variable		Data type		Name	
	_MC_AX[*].Obsr.Active		BOOL		Axis Observation Occurrence	
Cause and correction	Assumed cause		Correction		Prevention	
	The value of the member of the structure variable that was specified for the in-out variable of the instruction is out of range.		Correct the value of the member of the structure variable that is specified for the in-out variable of the relevant instruction so that it is in the valid range.		Make sure that the value of the member of the structure variable that is specified for the in-out variable of the relevant instruction is in the valid range.	
Attached information	Attached Information 1: Error Location Attached Information 3: Names of the Instruction and Instruction Instance Where the Error Occurred. If there is more than one possible instruction, information is given on all of them. Nothing is given if the instruction cannot be identified.					
Precautions/Remarks	If a program is changed after an error occurs, the attached information that is displayed may not be correct.					

*1. Error code 16#5726 occurs for unit version 1.06 or later of the CPU Unit.

Event name	Switch Structure Cam Switch Mode Out of Range		Event code	54015727 hex *1		
Meaning	The value of <i>CamSwitchMode</i> that is specified in the <i>Switches</i> in-out variable to a motion control instruction is out of range.					
Source	PLC Function Module		Source details	Instruction	Detection timing	At instruction execution
Error attributes	Level	Observation	Recovery	---	Log category	System
Effects	User program	Continues.	Operation	The relevant instruction will end according to specifications.		
System-defined variables	Variable		Data type		Name	
	_MC_AX[*].Obsr.Active		BOOL		Axis Observation Occurrence	
Cause and correction	Assumed cause		Correction		Prevention	
	The value of the member of the structure variable that was specified for the in-out variable of the instruction is out of range.		Correct the value of the member of the structure variable that is specified for the in-out variable of the relevant instruction so that it is in the valid range.		Make sure that the value of the member of the structure variable that is specified for the in-out variable of the relevant instruction is in the valid range.	
Attached information	Attached Information 1: Error Location Attached Information 3: Names of the Instruction and Instruction Instance Where the Error Occurred. If there is more than one possible instruction, information is given on all of them. Nothing is given if the instruction cannot be identified.					
Precautions/Remarks	If a program is changed after an error occurs, the attached information that is displayed may not be correct.					

*1. Error code 16#5727 occurs for unit version 1.06 or later of the CPU Unit.

Event name	Switch Structure Duration Setting Out of Range		Event code	54015728 hex *1	
Meaning	The value of <i>Duration</i> that is specified in the <i>Switches</i> in-out variable to a motion control instruction is out of range.				
Source	PLC Function Module		Source details	Instruction	Detection timing At instruction execution
Error attributes	Level	Observation	Recovery	---	Log category System
Effects	User program	Continues.	Operation	The relevant instruction will end according to specifications.	
System-defined variables	Variable	Data type		Name	
	_MC_AX[*].Obsr.Active	BOOL		Axis Observation Occurrence	
Cause and correction	Assumed cause		Correction		Prevention
	The value of the member of the structure variable that was specified for the in-out variable of the instruction is out of range.		Correct the value of the member of the structure variable that is specified for the in-out variable of the relevant instruction so that it is in the valid range.		Make sure that the value of the member of the structure variable that is specified for the in-out variable of the relevant instruction is in the valid range.
Attached information	Attached Information 1: Error Location Attached Information 3: Names of the Instruction and Instruction Instance Where the Error Occurred. If there is more than one possible instruction, information is given on all of them. Nothing is given if the instruction cannot be identified.				
Precautions/Remarks	If a program is changed after an error occurs, the attached information that is displayed may not be correct.				

*1. Error code 16#5728 occurs for unit version 1.06 or later of the CPU Unit.

Event name	Track Option Structure ON Compensation Setting Out of Range		Event code	54015729 hex *1	
Meaning	The value of <i>OnCompensation</i> that is specified in the <i>TrackOptions</i> in-out variable to a motion control instruction is out of range.				
Source	PLC Function Module		Source details	Instruction	Detection timing At instruction execution
Error attributes	Level	Observation	Recovery	---	Log category System
Effects	User program	Continues.	Operation	The relevant instruction will end according to specifications.	
System-defined variables	Variable	Data type		Name	
	_MC_AX[*].Obsr.Active	BOOL		Axis Observation Occurrence	
Cause and correction	Assumed cause		Correction		Prevention
	The value of the member of the structure variable that was specified for the in-out variable of the instruction is out of range.		Correct the value of the member of the structure variable that is specified for the in-out variable of the relevant instruction so that it is in the valid range.		Make sure that the value of the member of the structure variable that is specified for the in-out variable of the relevant instruction is in the valid range.
Attached information	Attached Information 1: Error Location Attached Information 3: Names of the Instruction and Instruction Instance Where the Error Occurred. If there is more than one possible instruction, information is given on all of them. Nothing is given if the instruction cannot be identified.				
Precautions/Remarks	If a program is changed after an error occurs, the attached information that is displayed may not be correct.				

*1. Error code 16#5729 occurs for unit version 1.06 or later of the CPU Unit.

Event name	Track Option Structure OFF Compensation Setting Out of Range		Event code	5401572A hex *1		
Meaning	The value of <i>TrackOptions</i> that is specified in the <i>OffCompensation</i> in-out variable to a motion control instruction is out of range.					
Source	PLC Function Module		Source details	Instruction	Detection timing	At instruction execution
Error attributes	Level	Observation	Recovery	---	Log category	System
Effects	User program	Continues.	Operation	The relevant instruction will end according to specifications.		
System-defined variables	Variable		Data type		Name	
	_MC_AX[*].Obsr.Active		BOOL		Axis Observation Occurrence	
Cause and correction	Assumed cause		Correction		Prevention	
	The value of the member of the structure variable that was specified for the in-out variable of the instruction is out of range.		Correct the value of the member of the structure variable that is specified for the in-out variable of the relevant instruction so that it is in the valid range.		Make sure that the value of the member of the structure variable that is specified for the in-out variable of the relevant instruction is in the valid range.	
Attached information	Attached Information 1: Error Location Attached Information 3: Names of the Instruction and Instruction Instance Where the Error Occurred. If there is more than one possible instruction, information is given on all of them. Nothing is given if the instruction cannot be identified.					
Precautions/Remarks	If a program is changed after an error occurs, the attached information that is displayed may not be correct.					

*1. Error code 16#572A occurs for unit version 1.06 or later of the CPU Unit.

Event name	Number of Array Elements in Switch Structure Variable Out of Range		Event code	5401572B hex *1		
Meaning	The number of elements in an array in the structure variable that is specified in the <i>Switches</i> in-out variable to a motion control instruction is out of range.					
Source	PLC Function Module		Source details	Instruction	Detection timing	At instruction execution
Error attributes	Level	Observation	Recovery	---	Log category	System
Effects	User program	Continues.	Operation	The relevant instruction will end according to specifications.		
System-defined variables	Variable		Data type		Name	
	_MC_AX[*].Obsr.Active		BOOL		Axis Observation Occurrence	
Cause and correction	Assumed cause		Correction		Prevention	
	The number of elements in an array of the structure variable that was specified for the in-out variable of the instruction is out of range.		Correct the number of elements in the array in the structure variable that is specified for the in-out variable of the relevant instruction so that it is in the valid range.		Make sure that the number of elements in the array in the structure variable that is specified for the in-out variable of the relevant instruction is in the valid range.	
Attached information	Attached Information 1: Error Location Attached Information 3: Names of the Instruction and Instruction Instance Where the Error Occurred. If there is more than one possible instruction, information is given on all of them. Nothing is given if the instruction cannot be identified.					
Precautions/Remarks	If a program is changed after an error occurs, the attached information that is displayed may not be correct.					

*1. Error code 16#572B occurs for unit version 1.06 or later of the CPU Unit.

Event name	Number of Array Elements in Output Signal Structure Variable Out of Range		Event code	5401572C hex *1		
Meaning	The number of elements in an array in the structure variable that is specified in the <i>Outputs</i> in-out variable to a motion control instruction is out of range.					
Source	PLC Function Module		Source details	Instruction	Detection timing	At instruction execution
Error attributes	Level	Observation	Recovery	---	Log category	System
Effects	User program	Continues.	Operation	The relevant instruction will end according to specifications.		
System-defined variables	Variable	Data type		Name		
	_MC_AX[*].Obsr.Active	BOOL		Axis Observation Occurrence		
Cause and correction	Assumed cause	Correction		Prevention		
	The number of elements in an array of the structure variable that was specified for the in-out variable of the instruction is out of range.	Correct the number of elements in the array in the structure variable that is specified for the in-out variable of the relevant instruction so that it is in the valid range.		Make sure that the number of elements in the array in the structure variable that is specified for the in-out variable of the relevant instruction is in the valid range.		
Attached information	Attached Information 1: Error Location Attached Information 3: Names of the Instruction and Instruction Instance Where the Error Occurred. If there is more than one possible instruction, information is given on all of them. Nothing is given if the instruction cannot be identified.					
Precautions/Remarks	If a program is changed after an error occurs, the attached information that is displayed may not be correct.					

*1. Error code 16#572C occurs for unit version 1.06 or later of the CPU Unit.

Event name	Number of Array Elements in Track Option Structure Variable Out of Range		Event code	5401572D hex *1		
Meaning	The number of elements in an array in the structure variable that is specified in the <i>TrackOptions</i> in-out variable to a motion control instruction is out of range.					
Source	PLC Function Module		Source details	Instruction	Detection timing	At instruction execution
Error attributes	Level	Observation	Recovery	---	Log category	System
Effects	User program	Continues.	Operation	The relevant instruction will end according to specifications.		
System-defined variables	Variable	Data type		Name		
	_MC_AX[*].Obsr.Active	BOOL		Axis Observation Occurrence		
Cause and correction	Assumed cause	Correction		Prevention		
	The number of elements in an array of the structure variable that was specified for the in-out variable of the instruction is out of range.	Correct the number of elements in the array in the structure variable that is specified for the in-out variable of the relevant instruction so that it is in the valid range.		Make sure that the number of elements in the array in the structure variable that is specified for the in-out variable of the relevant instruction is in the valid range.		
Attached information	Attached Information 1: Error Location Attached Information 3: Names of the Instruction and Instruction Instance Where the Error Occurred. If there is more than one possible instruction, information is given on all of them. Nothing is given if the instruction cannot be identified.					
Precautions/Remarks	If a program is changed after an error occurs, the attached information that is displayed may not be correct.					

*1. Error code 16#572D occurs for unit version 1.06 or later of the CPU Unit.

Event name	Numbers of Elements in Output Signals and Track Option Arrays Not Matched		Event code	5401572E hex *1		
Meaning	The arrays in the structure variables that are specified for the <i>Outputs</i> and <i>TrackOptions</i> in-out variables to a motion control instruction do not have the same number of elements.					
Source	PLC Function Module		Source details	Instruction	Detection timing	At instruction execution
Error attributes	Level	Observation	Recovery	---	Log category	System
Effects	User program	Continues.	Operation	The relevant instruction will end according to specifications.		
System-defined variables	Variable		Data type		Name	
	_MC_AX[*].Obsr.Active		BOOL		Axis Observation Occurrence	
Cause and correction	Assumed cause		Correction		Prevention	
	The arrays in the output signal structure variable and track option structure variable that are specified for the in-out variables to the instruction do not have the same number of elements.		Correct the output signal structure variable and track option structure variable that are specified for the in-out variables to the relevant instruction so that the arrays in them have the same number of elements.		Make sure that the arrays in the output signal structure variable and track option structure variable that are specified for the in-out variables to the relevant instruction have the same number of elements.	
Attached information	Attached Information 1: Error Location Attached Information 3: Names of the Instruction and Instruction Instance Where the Error Occurred. If there is more than one possible instruction, information is given on all of them. Nothing is given if the instruction cannot be identified.					
Precautions/Remarks	If a program is changed after an error occurs, the attached information that is displayed may not be correct.					

*1. Error code 16#572E occurs for unit version 1.06 or later of the CPU Unit.

Event name	Motion Control Instruction Multi-execution Disabled (Master Axis)		Event code	5401572F hex *1		
Meaning	A <i>Master</i> in-out variable that cannot be changed during multi-execution of instructions was changed.					
Source	PLC Function Module		Source details	Instruction	Detection timing	At instruction execution
Error attributes	Level	Observation	Recovery	---	Log category	System
Effects	User program	Continues.	Operation	The relevant instruction will end according to specifications.		
System-defined variables	Variable		Data type		Name	
	_MC_AX[*].MFaultLvl.Active		BOOL		Axis Minor Fault Occurrence	
Cause and correction	Assumed cause		Correction		Prevention	
	A <i>Master</i> in-out variable that cannot be changed during multi-execution of instructions was changed.		Correct the program so that the value of the <i>Master</i> in-out variable is not changed during multi-execution of the relevant instructions.		Write the program so that the value of the <i>Master</i> in-out variable is not changed during multi-execution of the relevant instructions.	
Attached information	Attached Information 1: Error Location Attached Information 3: Names of the Instruction and Instruction Instance Where the Error Occurred. If there is more than one possible instruction, information is given on all of them. Nothing is given if the instruction cannot be identified.					
Precautions/Remarks	If a program is changed after an error occurs, the attached information that is displayed may not be correct.					

*1. Error code 16#572F occurs for unit version 1.06 or later of the CPU Unit.

Event name	Motion Control Instruction Multi-execution Disabled (Position Type Selection)		Event code	54015730 hex *1		
Meaning	A <i>ReferenceType</i> in-out variable that cannot be changed during multi-execution of instructions was changed.					
Source	PLC Function Module		Source details	Instruction	Detection timing	At instruction execution
Error attributes	Level	Observation	Recovery	---	Log category	System
Effects	User program	Continues.	Operation	The relevant instruction will end according to specifications.		
System-defined variables	Variable	Data type		Name		
	_MC_AX[*].MFAultLvl.Active	BOOL		Axis Minor Fault Occurrence		
Cause and correction	Assumed cause	Correction		Prevention		
	A <i>ReferenceType</i> in-out variable that cannot be changed during multi-execution of instructions was changed.	Correct the program so that the value of the <i>ReferenceType</i> in-out variable is not changed during multi-execution of the relevant instructions.		Write the program so that the value of the <i>ReferenceType</i> in-out variable is not changed during multi-execution of the relevant instructions.		
Attached information	Attached Information 1: Error Location Attached Information 3: Names of the Instruction and Instruction Instance Where the Error Occurred. If there is more than one possible instruction, information is given on all of them. Nothing is given if the instruction cannot be identified.					
Precautions/Remarks	If a program is changed after an error occurs, the attached information that is displayed may not be correct.					

*1. Error code 16#5730 occurs for unit version 1.06 or later of the CPU Unit.

Event name	Same Track Number Setting in Switch Structure Out of Range		Event code	54015731 hex *1		
Meaning	The same track number was specified more than the allowable number of times for the <i>TrackNumber</i> in the <i>Switches</i> in-out variable to a motion control instruction.					
Source	PLC Function Module		Source details	Instruction	Detection timing	At instruction execution
Error attributes	Level	Observation	Recovery	---	Log category	System
Effects	User program	Continues.	Operation	The relevant instruction will end according to specifications.		
System-defined variables	Variable	Data type		Name		
	_MC_AX[*].Obsr.Active	BOOL		Axis Observation Occurrence		
Cause and correction	Assumed cause	Correction		Prevention		
	The same track number was specified more than the allowable number of times for the <i>TrackNumber</i> in the <i>Switches</i> in-out variable to a motion control instruction.	Correct the values in the <i>TrackNumber</i> so that the same track number is not specified more than the maximum number of times.		Set the values in the <i>TrackNumber</i> so that the same track number is not specified more than the maximum number of times.		
Attached information	Attached Information 1: Error Location Attached Information 3: Names of the Instruction and Instruction Instance Where the Error Occurred. If there is more than one possible instruction, information is given on all of them. Nothing is given if the instruction cannot be identified.					
Precautions/Remarks	If a program is changed after an error occurs, the attached information that is displayed may not be correct.					

*1. Error code 16#5731 occurs for unit version 1.06 or later of the CPU Unit.

Event name	Cannot Write Axis Parameters		Event code	5401573A hex *1	
Meaning	The instruction was executed for an axis that is not an unused axis.				
Source	PLC Function Module		Source details	Instruction	Detection timing At instruction execution
Error attributes	Level	Observation	Recovery	---	Log category System
Effects	User program	Continues.	Operation	The relevant instruction will end according to specifications.	
System-defined variables	Variable	Data type		Name	
	_MC_COM.MFaultLvl.Active	BOOL		MC Common Minor Fault Occurrence	
Cause and correction	Assumed cause		Correction		Prevention
	The instruction was executed for a used axis or an undefined axis.		Correct the program so that the MC_ChangeAxisUse (Change Axis Use) instruction is executed after the specified axis is changed to an unused axis.		Write the program so that the specified axis is an unused axis when the instruction is executed.
Attached information	Attached Information 1: Error Location Attached Information 3: Names of the Instruction and Instruction Instance Where the Error Occurred. If there is more than one possible instruction, information is given on all of them. Nothing is given if the instruction cannot be identified.				
Precautions/Remarks	If a program is changed after an error occurs, the attached information that is displayed may not be correct.				

*1. Error code 16#573A occurs for unit version 1.08 or later of the CPU Unit.

Event name	Axis Parameter Setting Out of Range		Event code	5401573B hex *1	
Meaning	The parameter specified for the <i>AxisParameter</i> input variable to a motion control instruction is outside of the valid range.				
Source	PLC Function Module		Source details	Instruction	Detection timing At instruction execution
Error attributes	Level	Observation	Recovery	---	Log category System
Effects	User program	Continues.	Operation	The relevant instruction will end according to specifications.	
System-defined variables	Variable	Data type		Name	
	_MC_COM.MFaultLvl.Active	BOOL		MC Common Minor Fault Occurrence	
Cause and correction	Assumed cause		Correction		Prevention
	The parameter specified for the <i>AxisParameter</i> input variable to the instruction is out of range for the input variable.		Correct the parameter so that the valid range of the input variable is not exceeded for the instruction. Confirm which parameter exceeded the range or what parameters are inconsistent in the attached information.		Set the input parameter to the instruction so that the valid range of the input variable is not exceeded. Refer to information on the MC_WriteAxisParameter (Write Axis Parameters) instruction for the valid ranges of the input variables.
Attached information	Attached Information 1: Error Location Attached Information 3: Names of the Instruction and Instruction Instance Where the Error Occurred. If there is more than one possible instruction, information is given on all of them. Nothing is given if the instruction cannot be identified.				
Precautions/Remarks	If a program is changed after an error occurs, the attached information that is displayed may not be correct.				

*1. Error code 16#573B occurs for unit version 1.08 or later of the CPU Unit.

Event name	Cam Property Setting Out of Range		Event code	5401573C hex *1	
Meaning	The parameter specified for the <i>CamProperty</i> input variable to a motion control instruction is outside of the valid range.				
Source	PLC Function Module		Source details	Instruction	Detection timing At instruction execution
Error attributes	Level	Observation	Recovery	---	Log category System
Effects	User program	Continues.	Operation	The relevant instruction will end according to specifications.	
System-defined variables	Variable	Data type		Name	
	_MC_COM.MFaultLvl.Active	BOOL		MC Common Minor Fault Occurrence	
Cause and correction	Assumed cause		Correction		Prevention
	The parameter specified for the <i>CamProperty</i> input variable to the instruction is out of range for the input variable.		Correct the parameter so that the valid range of the input variable is not exceeded for the instruction. Confirm which parameter exceeded the range in the attached information.		Set the input parameter to the instruction so that the valid range of the input variable is not exceeded.
Attached information	Attached Information 1: Error Location Attached Information 3: Names of the Instruction and Instruction Instance Where the Error Occurred. If there is more than one possible instruction, information is given on all of them. Nothing is given if the instruction cannot be identified.				
Precautions/Remarks	If a program is changed after an error occurs, the attached information that is displayed may not be correct.				

*1. Error code 16#573C occurs for unit version 1.08 or later of the CPU Unit.

Event name	Cam Node Setting Out of Range		Event code	5401573D hex *1	
Meaning	The parameter specified for the <i>CamNodes</i> input variable to a motion control instruction is outside of the valid range.				
Source	PLC Function Module		Source details	Instruction	Detection timing At instruction execution
Error attributes	Level	Observation	Recovery	---	Log category System
Effects	User program	Continues.	Operation	The relevant instruction will end according to specifications.	
System-defined variables	Variable	Data type		Name	
	_MC_COM.MFaultLvl.Active	BOOL		MC Common Minor Fault Occurrence	
Cause and correction	Assumed cause		Correction		Prevention
	The parameter specified for the <i>CamNodes</i> input variable to the instruction is out of range for the input variable.		Correct the parameter so that the valid range of the input variable is not exceeded for the instruction. Confirm which parameter exceeded the range in the attached information.		Set the input parameter to the instruction so that the valid range of the input variable is not exceeded.
Attached information	Attached Information 1: Error Location Attached Information 3: Names of the Instruction and Instruction Instance Where the Error Occurred. If there is more than one possible instruction, information is given on all of them. Nothing is given if the instruction cannot be identified.				
Precautions/Remarks	If a program is changed after an error occurs, the attached information that is displayed may not be correct.				

*1. Error code 16#573D occurs for unit version 1.08 or later of the CPU Unit.

Event name	Incorrect Cam Node Type Specification		Event code	5401573E hex *1	
Meaning	The parameter specified for the <i>CamNodes</i> input variable to a motion control instruction is not an <code>_sMC_CAM_NODE</code> array variable.				
Source	PLC Function Module		Source details	Instruction	Detection timing At instruction execution
Error attributes	Level	Observation	Recovery	---	Log category System
Effects	User program	Continues.	Operation	The relevant instruction will end according to specifications.	
System-defined variables	Variable	Data type		Name	
	<code>_MC_COM.MFaultLvl.Active</code>	BOOL		MC Common Minor Fault Occurrence	
Cause and correction	Assumed cause		Correction		Prevention
	The parameter specified for the <i>CamNodes</i> input variable to the instruction is not an <code>_sMC_CAM_NODE</code> array variable.		Correct the program to specify an <code>sMC_CAM_NODE</code> array variable for the input variable to the instruction.		Write the program to specify an <code>sMC_CAM_NODE</code> array variable for the input variable to the instruction.
Attached information	Attached Information 1: Error Location Attached Information 3: Names of the Instruction and Instruction Instance Where the Error Occurred. If there is more than one possible instruction, information is given on all of them. Nothing is given if the instruction cannot be identified.				
Precautions/Remarks	If a program is changed after an error occurs, the attached information that is displayed may not be correct.				

*1. Error code 16#573E occurs for unit version 1.08 or later of the CPU Unit.

Event name	Insufficient Nodes in Cam Table		Event code	5401573F hex *1	
Meaning	The array variable of the parameter specified for the <i>CamNodes</i> input variable to a motion control instruction has a Phase value of 0 for element number 0.				
Source	PLC Function Module		Source details	Instruction	Detection timing At instruction execution
Error attributes	Level	Observation	Recovery	---	Log category System
Effects	User program	Continues.	Operation	The relevant instruction will end according to specifications.	
System-defined variables	Variable	Data type		Name	
	<code>_MC_COM.MFaultLvl.Active</code>	BOOL		MC Common Minor Fault Occurrence	
Cause and correction	Assumed cause		Correction		Prevention
	The array variable of the parameter specified for the <i>CamNodes</i> input variable to the instruction has a Phase (master axis phase) value of 0 for element number 0.		Correct the program so that the value of Phase (master axis phase) for element number 0 in the array variable for the parameter specified for the <i>CamNodes</i> input variable is not 0.		Write the program so that the value of Phase (master axis phase) for element number 0 in the array variable for the parameter specified for the <i>CamNodes</i> input variable is not 0.
Attached information	Attached Information 1: Error Location Attached Information 3: Names of the Instruction and Instruction Instance Where the Error Occurred. If there is more than one possible instruction, information is given on all of them. Nothing is given if the instruction cannot be identified.				
Precautions/Remarks	If a program is changed after an error occurs, the attached information that is displayed may not be correct.				

*1. Error code 16#573F occurs for unit version 1.08 or later of the CPU Unit.

Event name	Cam Node Master Axis Phase Not in Ascending Order		Event code	54015740 hex *1		
Meaning	The values of Phase in the array variable of the parameter specified for the <i>CamNodes</i> input variable to a motion control instruction are not in ascending order according to the element numbers.					
Source	PLC Function Module		Source details	Instruction	Detection timing	At instruction execution
Error attributes	Level	Observation	Recovery	---	Log category	System
Effects	User program	Continues.	Operation	The relevant instruction will end according to specifications.		
System-defined variables	Variable	Data type		Name		
	_MC_COM.MFaultLvl.Active	BOOL		MC Common Minor Fault Occurrence		
Cause and correction	Assumed cause		Correction		Prevention	
	The values of Phase (master axis phase) in the array variable of the parameter specified for the <i>CamNodes</i> input variable to the instruction are not in ascending order according to the element numbers. Or, truncating the digits that are not effective more than seven digits caused the phases not to be in ascending order.		Correct the program so that the values of Phase (master axis phase) in the array variable for the parameter specified for the <i>CamNodes</i> input variable are in ascending order according to the element numbers.		Write the program so that the values of Phase (master axis phase) in the array variable for the parameter specified for the <i>CamNodes</i> input variable are in ascending order according to the element numbers.	
Attached information	Attached Information 1: Error Location Attached Information 3: Names of the Instruction and Instruction Instance Where the Error Occurred. If there is more than one possible instruction, information is given on all of them. Nothing is given if the instruction cannot be identified.					
Precautions/Remarks	If a program is changed after an error occurs, the attached information that is displayed may not be correct.					

*1. Error code 16#5740 occurs for unit version 1.08 or later of the CPU Unit.

Event name	Too Many Data Points in Cam Table		Event code	54015741 hex *1	
Meaning	The number of generated cam data points exceeded the number of elements in the array in the cam data variable that is specified for the <i>CamTable</i> input variable to a motion control instruction.				
Source	PLC Function Module		Source details	Instruction	Detection timing At instruction execution
Error attributes	Level	Observation	Recovery	---	Log category System
Effects	User program	Continues.	Operation	The relevant instruction will end according to specifications.	
System-defined variables	Variable	Data type		Name	
	_MC_COM.MFaultLvl.Active	BOOL		MC Common Minor Fault Occurrence	
Cause and correction	Assumed cause	Correction		Prevention	
	The number of cam data points in the generated cam table exceeded the number of elements in the array in the cam data variable that is specified for the <i>CamTable</i> input variable to the instruction.	Correct the program so that the number of cam data points in the generated cam table does not exceed the number of elements in the array in the cam data variable that is specified for the <i>CamTable</i> input variable to the instruction. Refer to information on the MC_GenerateCamTable (Generate Cam Table) instruction for the number of cam data points in generated cam tables.		Write the program so that the number of cam data points in the generated cam table does not exceed the number of elements in the array in the cam data variable that is specified for the <i>CamTable</i> input variable to the instruction. Refer to information on the MC_GenerateCamTable (Generate Cam Table) instruction for the number of cam data points in generated cam tables.	
Attached information	Attached Information 1: Error Location Attached Information 3: Names of the Instruction and Instruction Instance Where the Error Occurred. If there is more than one possible instruction, information is given on all of them. Nothing is given if the instruction cannot be identified.				
Precautions/Remarks	If a program is changed after an error occurs, the attached information that is displayed may not be correct.				

*1. Error code 16#5741 occurs for unit version 1.08 or later of the CPU Unit.

Event name	Cam Table Displacement Overflow		Event code	54015742 hex *1		
Meaning	Distance in the generated cam table exceeded the range of REAL data.					
Source	PLC Function Module	Source details	Instruction	Detection timing	At instruction execution or during instruction execution	
Error attributes	Level	Observation	Recovery	---	Log category	System
Effects	User program	Continues.	Operation	The relevant instruction will end according to specifications.		
System-defined variables	Variable	Data type		Name		
	_MC_COM.MFaultLvl.Active	BOOL		MC Common Minor Fault Occurrence		
Cause and correction	Assumed cause	Correction		Prevention		
	Distance in the generated cam table exceeded the range of REAL data.	Correct the values of InitVel (initial velocity), ConnectingVel (connecting velocity), and ConnectingAcc (connecting acceleration) so that Distance does not overflow when a polynomial 3 curve or polynomial 5 curve is specified for Curve (curve shape) in the <i>CamNodes</i> input variable. Refer to information on the MC_GenerateCamTable (Generate Cam Table) instruction for the method to calculate Distance.		Specify the values of InitVel (initial velocity), ConnectingVel (connecting velocity), and ConnectingAcc (connecting acceleration) so that Distance does not overflow when a polynomial 3 curve or polynomial 5 curve is specified for Curve (curve shape) in the <i>CamNodes</i> input variable. Refer to information on the MC_GenerateCamTable (Generate Cam Table) instruction for the method to calculate Distance.		
Attached information	Attached Information 1: Error Location Attached Information 3: Names of the Instruction and Instruction Instance Where the Error Occurred. If there is more than one possible instruction, information is given on all of them. Nothing is given if the instruction cannot be identified.					
Precautions/Remarks	If a program is changed after an error occurs, the attached information that is displayed may not be correct.					

*1. Error code 16#5742 occurs for unit version 1.08 or later of the CPU Unit.

Event name	Aborted Cam Table Used		Event code	54015743 hex *1		
Meaning	A cam data variable that was aborted during generation was specified for the <i>CamTableA</i> cam data variable that was aborted during generation was specified for the					
Source	PLC Function Module		Source details	Instruction	Detection timing	At instruction execution
Error attributes	Level	Observation	Recovery	---	Log category	System
Effects	User program	Continues.	Operation	The relevant instruction will end according to specifications.		
System-defined variables	Variable	Data type		Name		
	_MC_COM.MFaultLvl.Active	BOOL		MC Common Minor Fault Occurrence		
	_MC_AX[*].MFaultLvl.Active	BOOL		Axis Minor Fault Occurrence		
Cause and correction	Assumed cause		Correction		Prevention	
	A cam data variable that was aborted during generation due to an error in the MC_GenerateCamTable (Generate Cam Table) instruction was specified for the <i>CamTable</i> input variable to the instruction.		Check the ErrorID (end code), ErrorParameterCode (parameter detail code), and ErrorNodePointIndex (node point element number) output variables from the MC_GenerateCamTable (Generate Cam Table) instruction and correct the program so that correct cam table variables are created.		Write the program so that the MC_GenerateCamTable (Generate Cam Table) instruction creates correct cam data variables. Or, write the program so that the relevant instruction is executed only when the MC_GenerateCamTable (Generate Cam Table) instruction ends normally.	
Attached information	Attached Information 1: Error Location Attached Information 3: Names of the Instruction and Instruction Instance Where the Error Occurred. If there is more than one possible instruction, information is given on all of them. Nothing is given if the instruction cannot be identified.					
Precautions/Remarks	If a program is changed after an error occurs, the attached information that is displayed may not be correct.					

*1. Error code 16#5743 occurs for unit version 1.08 or later of the CPU Unit.

Event name	Execution ID Setting Out of Range		Event code	54015749 hex *1		
Meaning	The parameter specified for the <i>ExecID</i> input variable to a motion control instruction is out of range.					
Source	PLC Function Module		Source details	Instruction	Detection timing	At instruction execution
Error attributes	Level	Observation	Recovery	---	Log category	System
Effects	User program	Continues.	Operation	The relevant instruction will end according to specifications.		
System-defined variables	Variable	Data type		Name		
	_MC_AX[*].MFaultLvl.Active	BOOL		Axis Minor Fault Occurrence		
Cause and correction	Assumed cause		Correction		Prevention	
	The parameter specified for the <i>ExecID</i> input variable to the instruction is out of range for the input variable.		Correct the program so that the input parameter specified for the <i>ExecID</i> input variable to the instruction is within the setting range.		Create the program so that the input parameter specified for the <i>ExecID</i> input variable to the instruction is within the setting range.	
Attached information	Attached Information 1: Error Location Attached Information 3: Names of the Instruction and Instruction Instance Where the Error Occurred. If there is more than one possible instruction, information is given on all of them. Nothing is given if the instruction cannot be identified.					
Precautions/Remarks	If a program is changed after an error occurs, the attached information that is displayed may not be correct.					

*1. Error code 16#5749 occurs for unit version 1.10 or later of the CPU Unit.

Event name	Position Offset Out of Range		Event code	5401574A hex *1	
Meaning	The parameter specified for the <i>OffsetPosition</i> input variable to a motion control instruction is out of range.				
Source	PLC Function Module		Source details	Instruction	Detection timing At instruction execution
Error attributes	Level	Observation	Recovery	---	Log category System
Effects	User program	Continues.	Operation	The relevant instruction will end according to specifications.	
System-defined variables	Variable	Data type		Name	
	_MC_AX[*].MFAultLvl.Active	BOOL		Axis Minor Fault Occurrence	
Cause and correction	Assumed cause		Correction		Prevention
	The instruction input parameter exceeded the range of signed 40-bit data when it was converted to pulses.		Correct the parameter so that the valid range of the input variable is not exceeded for the relevant instruction.		Set the input parameter to the instruction so that the valid range of the input variable is not exceeded.
Attached information	Attached Information 1: Error Location Attached Information 3: Names of the Instruction and Instruction Instance Where the Error Occurred. If there is more than one possible instruction, information is given on all of them. Nothing is given if the instruction cannot be identified.				
Precautions/Remarks	If a program is changed after an error occurs, the attached information that is displayed may not be correct.				

*1. Error code 16#574A occurs for unit version 1.10 or later of the CPU Unit.

Event name	PDS State Transition Command Selection Out of Range		Event code	5401574B hex *1	
Meaning	The parameter specified for the <i>TransitionCmd</i> input variable to a motion control instruction is out of range.				
Source	PLC Function Module		Source details	Instruction	Detection timing At instruction execution
Error attributes	Level	Observation	Recovery	---	Log category System
Effects	User program	Continues.	Operation	The relevant instruction will end according to specifications.	
System-defined variables	Variable	Data type		Name	
	_MC_AX[*].MFAultLvl.Active	BOOL		Axis Minor Fault Occurrence	
Cause and correction	Assumed cause		Correction		Prevention
	Instruction input parameter exceeded the valid range of the input variable.		Correct the parameter so that the valid range of the input variable is not exceeded for the relevant instruction.		Set the input parameter to the instruction so that the valid range of the input variable is not exceeded.
Attached information	Attached Information 1: Error Location Attached Information 3: Names of the Instruction and Instruction Instance Where the Error Occurred. If there is more than one possible instruction, information is given on all of them. Nothing is given if the instruction cannot be identified.				
Precautions/Remarks	If a program is changed after an error occurs, the attached information that is displayed may not be correct.				

*1. Error code 16#574B occurs for unit version 1.10 or later of the CPU Unit.

Event name	Single-axis Position Control Axis Motion Control Instruction Execution Disabled		Event code	5401574C hex *1		
Meaning	An operation instruction was executed for a single-axis position control axis.					
Source	PLC Function Module		Source details	Instruction	Detection timing	At instruction execution
Error attributes	Level	Observation	Recovery	---	Log category	System
Effects	User program	Continues.	Operation	The relevant instruction will end according to specifications.		
System-defined variables	Variable		Data type		Name	
	_MC_AX[*].MFAultLvl.Active		BOOL		Axis Minor Fault Occurrence	
Cause and correction	Assumed cause		Correction		Prevention	
	An operation instruction was executed for a single-axis position control axis.		In the Axis Basic Settings for the axis specified in the instruction, set the Control Function parameter to 0: All. Or specify the axis for which the Control Function parameter is set to 0: All in the Axis Basic Settings.		Same as at the left.	
Attached information	Attached Information 1: Error Location Attached Information 3: Names of the Instruction and Instruction Instance Where the Error Occurred. If there is more than one possible instruction, information is given on all of them. Nothing is given if the instruction cannot be identified.					
Precautions/Remarks	If a program is changed after an error occurs, the attached information that is displayed may not be correct.					

*1. Error code 16#574C occurs for unit version 1.13 or later of the CPU Unit.

Event name	Cam Monitor Mode Selection Out of Range		Event code	54015751 hex *1		
Meaning	The cam monitor mode selection specified for the <i>CamMonitorMode</i> input variable to a motion control instruction is out of range.					
Source	PLC Function Module		Source details	Instruction	Detection timing	At instruction execution
Error attributes	Level	Observation	Recovery	---	Log category	System
Effects	User program	Continues.	Operation	The relevant instruction will end according to specifications.		
System-defined variables	Variable		Data type		Name	
	_MC_AX[*].MFAultLvl.Active		BOOL		Axis Minor Fault Occurrence	
Cause and correction	Assumed cause		Correction		Prevention	
	The cam monitor mode selection is out of the valid range.		Make a correction so that the cam monitor mode selection is within the valid range.		Make a setting so that the cam monitor mode selection is within the valid range.	
Attached information	Attached information 1: Error Location Attached information 3: Names of the Instruction and Instruction Instance Where the Error Occurred. If there is more than one possible instruction, information is given on all of them. Nothing is given if the instruction cannot be identified.					
Precautions/Remarks	If a program is changed after an error occurs, the attached information that is displayed may not be correct.					

*1. This error code (16#5751) occurs for an NX102-□□□□ CPU Unit with unit version 1.32 or later and NX701-□□□□ CPU Unit, NX1P2-□□□□□□ CPU Unit, NJ501-□□□□ CPU Unit (excluding NJ501-□□, NJ301-□□□□ CPU Unit, and NJ101-□□□□ CPU Unit with unit version 1.21 or later.

Event name	Data Type of Cam Monitor Values Mismatch		Event code	54015752 hex *1	
Meaning	The data type of the cam monitor values specified for the <i>CamMonitorValue</i> in-out variable to a motion control instruction does not match the cam monitor mode selection.				
Source	PLC Function Module		Source details	Instruction	Detection timing At instruction execution
Error attributes	Level	Observation	Recovery	---	Log category System
Effects	User program	Continues.	Operation	The relevant instruction will end according to specifications.	
System-defined variables	Variable	Data type		Name	
	_MC_AX[*].MFAultLvl.Active	BOOL		Axis Minor Fault Occurrence	
Cause and correction	Assumed cause		Correction		Prevention
	The data type of the variable specified for the cam monitor values does not match the cam monitor mode selection.		Make a correction of the data type of the variable specified for the cam monitor values.		Set the data type of the variable specified for the cam monitor values correctly.
Attached information	Attached information 1: Error Location Attached information 3: Names of the Instruction and Instruction Instance Where the Error Occurred. If there is more than one possible instruction, information is given on all of them. Nothing is given if the instruction cannot be identified.				
Precautions/Remarks	If a program is changed after an error occurs, the attached information that is displayed may not be correct.				

*1. This error code (16#5752) occurs for an NX102-□□□□ CPU Unit with unit version 1.32 or later and NX701-□□00 CPU Unit, NX1P2-□□□□□□ CPU Unit, NJ501-□□□□ CPU Unit (excluding NJ501-□□20), NJ301-□□□□ CPU Unit, and NJ101-□□00 CPU Unit with unit version 1.21 or later.

Event name	Sync Mode Setting Out of Range		Event code	54015753 hex *1	
Meaning	The parameter specified for the <i>SyncMode</i> input variable to a motion control instruction is out of range.				
Source	PLC Function Module		Source details	Instruction	Detection timing At instruction execution
Error attributes	Level	Observation	Recovery	--	Log category System
Effects	User program	Continues.	Operation	The relevant instruction will end according to specifications.	
System-defined variables	Variable	Data type		Name	
	_MC_AX[*].MFAultLvl.Active	BOOL		Axis Minor Fault Occurrence	
Cause and correction	Assumed cause		Correction		Prevention
	Instruction input parameter exceeded the valid range of the input variable.		Correct the parameter so that the valid range of the input variable is not exceeded for the relevant instruction.		Set the input parameter to the instruction so that the valid range of the input variable is not exceeded.
Attached information	Attached information 1: Error Location Attached information 3: Names of the Instruction and Instruction Instance Where the Error Occurred. If there is more than one possible instruction, information is given on all of them. Nothing is given if the instruction cannot be identified.				
Precautions/Remarks	If a program is changed after an error occurs, the attached information that is displayed may not be correct.				

*1. The error code (16#5753) occurs for an NJ-series, NX102, NX1P2, or NX502 CPU Unit with unit version 1.70 or later and an NX701 CPU Unit with unit version 1.37 or later.

Event name	Gear Master Axis Following First Position Setting Out of Range		Event code	54015754 hex *1		
Meaning	The parameter specified for the <i>MasterStartDistance</i> input variable to a motion control instruction is out of range.					
Source	PLC Function Module		Source details	Instruction	Detection timing	At instruction execution
Error attributes	Level	Observation	Recovery	--	Log category	System
Effects	User program	Continues.	Operation	The relevant instruction will end according to specifications.		
System-defined variables	Variable	Data type		Name		
	_MC_AX[*].MFAultLvl.Active	BOOL		Axis Minor Fault Occurrence		
Cause and correction	Assumed cause		Correction		Prevention	
	Instruction input parameter exceeded the valid range of the input variable.		Correct the parameter so that the valid range of the input variable is not exceeded for the relevant instruction.		Set the input parameter to the instruction so that the valid range of the input variable is not exceeded.	
Attached information	Attached information 1: Error Location Attached information 3: Names of the Instruction and Instruction Instance Where the Error Occurred. If there is more than one possible instruction, information is given on all of them. Nothing is given if the instruction cannot be identified.					
Precautions/Remarks	If a program is changed after an error occurs, the attached information that is displayed may not be correct.					

*1. The error code (16#5754) occurs for an NJ-series, NX102, NX1P2, or NX502 CPU Unit with unit version 1.70 or later and an NX701 CPU Unit with unit version 1.37 or later.

Event name	Torque Limit Mode Setting Out of Range		Event code	54015755 hex *1		
Meaning	The parameter specified for the <i>TorqueLimitMode</i> input variable to a motion control instruction is out of range.					
Source	PLC Function Module		Source details	Instruction	Detection timing	At instruction execution
Error attributes	Level	Observation	Recovery	--	Log category	System
Effects	User program	Continues.	Operation	The relevant instruction will end according to specifications.		
System-defined variables	Variable	Data type		Name		
	_MC_AX[*].MFAultLvl.Active	BOOL		Axis Minor Fault Occurrence		
Cause and correction	Assumed cause		Correction		Prevention	
	Instruction input parameter exceeded the valid range of the input variable.		Correct the parameter so that the valid range of the input variable is not exceeded for the relevant instruction.		Set the input parameter to the instruction so that the valid range of the input variable is not exceeded.	
Attached information	Attached information 1: Error Location Attached information 3: Names of the Instruction and Instruction Instance Where the Error Occurred. If there is more than one possible instruction, information is given on all of them. Nothing is given if the instruction cannot be identified.					
Precautions/Remarks	If a program is changed after an error occurs, the attached information that is displayed may not be correct.					

*1. The error code (16#5755) occurs for an NJ-series, NX102, NX1P2, or NX502 CPU Unit with unit version 1.70 or later and an NX701 CPU Unit with unit version 1.37 or later.

Event name	Insufficient Cam Nodes		Event code	54015756 hex *1		
Meaning	The array variable of the parameter specified for the <i>CamNodes</i> input variable to a motion control instruction has a <i>Phase</i> value of 0 for element number 0.					
Source	PLC Function Module		Source details	Instruction	Detection timing	At instruction execution
Error attributes	Level	Observation	Recovery	--	Log category	System
Effects	User program	Continues.	Operation	The relevant instruction will end according to specifications.		
System-defined variables	Variable	Data type		Name		
	_MC_AX[*].MFAultLvl.Active	BOOL		Axis Minor Fault Occurrence		
Cause and correction	Assumed cause		Correction		Prevention	
	The array variable of the parameter specified for <i>CamNodes</i> input variable to the instruction has a <i>Phase</i> (master axis phase) value of 0 for element number 0.		Correct the program so that the value of <i>Phase</i> (master axis phase) for element number 0 in the array variable for the parameter specified for the <i>CamNodes</i> input variable is not 0.		Write the program so that the value of <i>Phase</i> (master axis phase) for element number 0 in the array variable for the parameter specified for the <i>CamNodes</i> input variable is not 0.	
Attached information	Attached information 1: Error Location Attached information 3: Names of the Instruction and Instruction Instance Where the Error Occurred. If there is more than one possible instruction, information is given on all of them. Nothing is given if the instruction cannot be identified.					
Precautions/Remarks	If a program is changed after an error occurs, the attached information that is displayed may not be correct.					

*1. The error code (16#5756) occurs for an NJ-series, NX102, NX1P2, or NX502 CPU Unit with unit version 1.70 or later and an NX701 CPU Unit with unit version 1.37 or later.

Event name	Cam Node Start Point Position Out of Range		Event code	54015757 hex *1		
Meaning	The parameter specified for the <i>StartPosition</i> input variable to a motion control instruction is out of range.					
Source	PLC Function Module		Source details	Instruction	Detection timing	At instruction execution
Error attributes	Level	Observation	Recovery	--	Log category	System
Effects	User program	Continues.	Operation	The relevant instruction will end according to specifications.		
System-defined variables	Variable	Data type		Name		
	_MC_AX[*].MFAultLvl.Active	BOOL		Axis Minor Fault Occurrence		
Cause and correction	Assumed cause		Correction		Prevention	
	Instruction input parameter exceeded the valid range of the input variable.		Correct the parameter so that the valid range of the input variable is not exceeded for the relevant instruction.		Set the input parameter to the instruction so that the valid range of the input variable is not exceeded.	
Attached information	Attached information 1: Error Location Attached information 3: Names of the Instruction and Instruction Instance Where the Error Occurred. If there is more than one possible instruction, information is given on all of them. Nothing is given if the instruction cannot be identified.					
Precautions/Remarks	If a program is changed after an error occurs, the attached information that is displayed may not be correct.					

*1. The error code (16#5757) occurs for an NJ-series, NX102, NX1P2, or NX502 CPU Unit with unit version 1.70 or later and an NX701 CPU Unit with unit version 1.37 or later.

Event name	Cam Operation Displacement Overflow		Event code	54015758 hex *1	
Meaning	The displacement calculated for the cam operation is out of range.				
Source	PLC Function Module		Source details	Instruction	Detection timing At instruction execution or during instruction execution
Error attributes	Level	Observation	Recovery	--	Log category System
Effects	User program	Continues.	Operation	The relevant instruction will end according to specifications.	
System-defined variables	Variable	Data type		Name	
	_MC_AX[*].MFAultLvl.Active	BOOL		Axis Minor Fault Occurrence	
Cause and correction	Assumed cause		Correction		Prevention
	The absolute value of the product of the cam profile curve displacement and the <i>SlaveScaling</i> input variable when it is converted to pulses exceeds the range of 40-bit data.		Make corrections so that the product of the cam profile curve displacement and the <i>SlaveScaling</i> input variable is not out of range. When a polynomial 3 or polynomial 5 curve is specified for the <i>Curve</i> in the <i>CamNodes</i> input variable, make adjustments so that the displacement is within range based on the equations described in the MC_CamInCurve (Start Cam Operation With Specified Curve) instruction.		Make corrections so that the product of the cam profile curve displacement and the <i>SlaveScaling</i> input variable is not out of range. When a polynomial 3 or polynomial 5 curve is specified for the <i>Curve</i> in the <i>CamNodes</i> input variable, make adjustments so that the displacement is within range based on the equations described in the MC_CamInCurve (Start Cam Operation With Specified Curve) instruction.
Attached information	Attached information 1: Error Location Attached information 3: Names of the Instruction and Instruction Instance Where the Error Occurred. If there is more than one possible instruction, information is given on all of them. Nothing is given if the instruction cannot be identified.				
Precautions/Remarks	If a program is changed after an error occurs, the attached information that is displayed may not be correct.				

*1. The error code (16#5758) occurs for an NJ-series, NX102, NX1P2, or NX502 CPU Unit with unit version 1.70 or later and an NX701 CPU Unit with unit version 1.37 or later.

Event name	Reversing Operation Not Possible		Event code	54015759 hex *1		
Meaning	When Slave axis reversing not possible is specified in the <i>SyncMode</i> input variable to a motion control instruction, the slave axis has entered an operation pattern causing reversing motion.					
Source	PLC Function Module		Source details	Instruction	Detection timing	At instruction execution or during instruction execution
Error attributes	Level	Observation	Recovery	---	Log category	System
Effects	User program	Continues.	Operation	The relevant instruction will end according to specifications.		
System-defined variables	Variable	Data type		Name		
	_MC_AX[*].MFAultLvl.Active	BOOL		Axis Minor Fault Occurrence		
Cause and correction	Assumed cause		Correction		Prevention	
	When Slave axis reversing not possible is specified in the <i>SyncMode</i> input variable, the slave axis has entered an operation causing reversing motion due to the difference in the direction of velocity at the start of catching and during synchronization.		Correct the program based on the operating specifications of the MC_GearInPos2 (Positioning Gear Operation2) instruction so that the direction of velocity at the start of catching and during synchronization matches.		Correct the program based on the operating specifications of the MC_GearInPos2 (Positioning Gear Operation2) instruction so that the direction of velocity at the start of catching and during synchronization matches.	
Attached information	Attached information 1: Error Location Attached information 3: Names of the Instruction and Instruction Instance Where the Error Occurred. If there is more than one possible instruction, information is given on all of them. Nothing is given if the instruction cannot be identified.					
Precautions/Remarks	If a program is changed after an error occurs, the attached information that is displayed may not be correct.					

*1. The error code (16#5759) occurs for an NJ-series, NX102, NX1P2, or NX502 CPU Unit with unit version 1.70 or later and an NX701 CPU Unit with unit version 1.37 or later.

Event name	X Bus Unit Does Not Exist		Event code	54015800 hex		
Meaning	The specified Unit does not exist.					
Source	PLC Function Module		Source details	Instruction	Detection timing	At instruction execution
Error attributes	Level	Observation	Recovery	---	Log category	System
Effects	User program	Continues.	Operation	The relevant instruction will end according to specifications.		
System-defined variables	Variable	Data type		Name		
	None	---		---		
Cause and correction	Assumed cause		Correction		Prevention	
	The specified X Bus Unit does not exist.		Make corrections so that the Unit specifications and the remote Unit configuration agree.		Make sure that Unit specifications and the remote Unit configuration agree.	
Attached information	Attached information 1: Error Location Attached information 2: Error Location Details (Rung Number). For a program section, the rung number from the start of the section is given. For ST, the line number is given. Attached information 3: Names of the Instruction and Instruction Instance Where the Error Occurred. If there is more than one possible instruction, information is given on all of them. Nothing is given if the instruction cannot be identified. Attached information 4: Expansion Error Code (ErrorIDEx) for the instruction which has an Expansion Error Code (ErrorIDEx). For the instruction without an Expansion Error Code (ErrorIDEx), 0x00000000 is given.					
Precautions/Remarks	None					

Event name	Response Timeout		Event code	54015801 hex	
Meaning	No response was received from the specified Unit.				
Source	PLC Function Module		Source details	Instruction	Detection timing At instruction execution
Error attributes	Level	Observation	Recovery	---	Log category System
Effects	User program	Continues.	Operation	The relevant instruction will end according to specifications.	
System-defined variables	Variable	Data type		Name	
	None	---		---	
Cause and correction	Assumed cause		Correction		Prevention
	Communications with the specified Unit stopped due to either an X Bus Unit Startup Error, X Bus Unit Communications Error, or X Bus Function Processing Error.		Recover the specified Unit from its abnormal state and start it up normally.		Make sure that there is no abnormality in the specified Unit, and then start communications.
	The set response monitoring time is too short.		Change the value set for response monitoring time.		None
Attached information	<p>Attached information 1: Error Location</p> <p>Attached information 2: Error Location Details (Rung Number). For a program section, the rung number from the start of the section is given. For ST, the line number is given.</p> <p>Attached information 3: Names of the Instruction and Instruction Instance Where the Error Occurred. If there is more than one possible instruction, information is given on all of them. Nothing is given if the instruction cannot be identified.</p> <p>Attached information 4: Expansion Error Code (ErrorIDEx) for the instruction which has an Expansion Error Code (ErrorIDEx). For the instruction without an Expansion Error Code (ErrorIDEx), 0x00000000 is given.</p>				
Precautions/Remarks	None				

Event name	Cannot Execute at Specified Unit/Port			Event code	54015C00 hex	
Meaning	A tag data link control instruction was executed when execution was not possible. Or, the EtherNet/IP port designated by the specified Unit and port number does not exist.					
Source	PLC Function Module		Source details	Instruction	Detection timing	At instruction execution
Error attributes	Level	Observation	Recovery	---	Log category	System
Effects	User program	Continues.	Operation	Not affected.		
System-defined variables	Variable	Data type		Name		
	None	---		---		
Cause and correction	Assumed cause		Correction		Prevention	
	<ul style="list-style-type: none"> An instruction was executed while the EtherNet/IP port is being restarted or tag data link settings are being downloaded from Network Configurator. The EtherNet/IP port designated by the specified Unit and port number does not exist. 		<ul style="list-style-type: none"> Execute the instruction after restarting the EtherNet/IP port or changing settings. Designate the specified Unit and port number that exist in the configuration setting of the X Bus Unit. Make sure that the Unit specified by the instruction is connected properly. 		<ul style="list-style-type: none"> Execute the instruction when the EtherNet/IP port is not restarting or settings are not being changed. Designate the specified Unit and port number that exist in the configuration setting of the X Bus Unit. Properly connect the Unit specified by the instruction. 	
Attached information	<p>Attached information 1: Error Location</p> <p>Attached information 2: Error Location Details (Rung Number). For a program section, the rung number from the start of the section is given. For ST, the line number is given.</p> <p>Attached information 3: Names of the Instruction and Instruction Instance Where the Error Occurred. If there is more than one possible instruction, information is given on all of them. Nothing is given if the instruction cannot be identified.</p> <p>Attached information 4: Expansion Error Code (ErrorIDEx) for the instruction which has an Expansion Error Code (ErrorIDEx). For the instruction without an Expansion Error Code (ErrorIDEx), 0x00000000 is given.</p>					
Precautions/Remarks	None					

Event name	Too Many Simultaneous Instruction Executions			Event code	54015C01 hex	
Meaning	Tag data link control instructions were executed and the number of instructions exceeded the maximum number that can be executed simultaneously.					
Source	PLC Function Module		Source details	Instruction	Detection timing	At instruction execution
Error attributes	Level	Observation	Recovery	---	Log category	System
Effects	User program	Continues.	Operation	Not affected.		
System-defined variables	Variable	Data type		Name		
	None	---		---		
Cause and correction	Assumed cause		Correction		Prevention	
	Two or more tag data link control instructions were executed simultaneously.		Correct the program so that only one tag data link control instruction is executed at a time.		Create a program so that only one tag data link control instruction is executed at a time.	
Attached information	<p>Attached information 1: Error Location</p> <p>Attached information 2: Error Location Details (Rung Number). For a program section, the rung number from the start of the section is given. For ST, the line number is given.</p> <p>Attached information 3: Names of the Instruction and Instruction Instance Where the Error Occurred. If there is more than one possible instruction, information is given on all of them. Nothing is given if the instruction cannot be identified.</p> <p>Attached information 4: Expansion Error Code (ErrorIDEx) for the instruction which has an Expansion Error Code (ErrorIDEx). For the instruction without an Expansion Error Code (ErrorIDEx), 0x00000000 is given.</p>					
Precautions/Remarks	None					

Event name	Target Node IP Address Does Not Exist		Event code	54015C03 hex	
Meaning	Connection settings with the target node IP address do not exist on the Ethernet/IP port specified by the specified Unit and port number.				
Source	PLC Function Module		Source details	Instruction	Detection timing At instruction execution
Error attributes	Level	Observation	Recovery	---	Log category System
Effects	User program	Continues.	Operation	Not affected.	
System-defined variables	Variable	Data type		Name	
	None	---		---	
Cause and correction	Assumed cause		Correction		Prevention
	Connection settings with the target node IP address do not exist on the Ethernet/IP port specified by the specified Unit and port number.		Specify the target node IP address that exists in the connection settings of the EtherNet/IP port specified by the corresponding instruction.		Specify the target node IP address that exists in the connection settings of the EtherNet/IP port specified by the corresponding instruction.
Attached information	<p>Attached information 1: Error Location</p> <p>Attached information 2: Error Location Details (Rung Number). For a program section, the rung number from the start of the section is given. For ST, the line number is given.</p> <p>Attached information 3: Names of the Instruction and Instruction Instance Where the Error Occurred. If there is more than one possible instruction, information is given on all of them. Nothing is given if the instruction cannot be identified.</p> <p>Attached information 4: Expansion Error Code (ErrorIDEx) for the instruction which has an Expansion Error Code (ErrorIDEx). For the instruction without an Expansion Error Code (ErrorIDEx), 0x00000000 is given.</p>				
Precautions/Remarks	None				

Event name	Connection Communications Error			Event code	54015C04 hex
Meaning	Communications can not be established with the target node specified by target node IP address.				
Source	PLC Function Module		Source details	Instruction	Detection timing At instruction execution
Error attributes	Level	Observation	Recovery	---	Log category System
Effects	User program	Continues.	Operation	Not affected.	
System-defined variables	Variable	Data type		Name	
	None	---		---	
Cause and correction	Assumed cause		Correction		Prevention
	<ul style="list-style-type: none"> Target node is not connected properly. The power supply to the target node is OFF. The Ethernet cable is broken, or loose. Noise 		<ul style="list-style-type: none"> Make sure the target node is properly connected. Make sure the power supply to the target node is ON. Make sure that the Ethernet cable is not broken or disconnected. Make sure there is no excessive noise. 		<ul style="list-style-type: none"> Connect the target node is properly. Turn ON the power supply to the target node. Replace the Ethernet cable and connect it securely. Implement noise countermeasures if there is excessive noise.
Attached information	<p>Attached information 1: Error Location</p> <p>Attached information 2: Error Location Details (Rung Number). For a program section, the rung number from the start of the section is given. For ST, the line number is given.</p> <p>Attached information 3: Names of the Instruction and Instruction Instance Where the Error Occurred. If there is more than one possible instruction, information is given on all of them. Nothing is given if the instruction cannot be identified.</p> <p>Attached information 4: Expansion Error Code (ErrorIDEx) for the instruction which has an Expansion Error Code (ErrorIDEx). For the instruction without an Expansion Error Code (ErrorIDEx), 0x00000000 is given.</p>				
Precautions/Remarks	None				

Event name	Connection Setting Error			Event code	54015C05 hex
Meaning	An abnormal response from the target node was received.				
Source	PLC Function Module		Source details	Instruction	Detection timing At instruction execution
Error attributes	Level	Observation	Recovery	---	Log category System
Effects	User program	Continues.	Operation	Not affected.	
System-defined variables	Variable	Data type		Name	
	None	---		---	
Cause and correction	Assumed cause		Correction		Prevention
	Connection settings are incorrect.		Modify connection settings and download the settings from Network Configurator or Sysmac Studio.		Create correct connection settings and download the settings from Network Configurator or Sysmac Studio.
Attached information	<p>Attached information 1: Error Location</p> <p>Attached information 2: Error Location Details (Rung Number). For a program section, the rung number from the start of the section is given. For ST, the line number is given.</p> <p>Attached information 3: Names of the Instruction and Instruction Instance Where the Error Occurred. If there is more than one possible instruction, information is given on all of them. Nothing is given if the instruction cannot be identified.</p> <p>Attached information 4: Expansion Error Code (ErrorIDEx) for the instruction which has an Expansion Error Code (ErrorIDEx). For the instruction without an Expansion Error Code (ErrorIDEx), 0x00000000 is given.</p>				
Precautions/Remarks	None				

Event name	Target Position Positive Software Limit Exceeded		Event code	54016440 hex	
Meaning	The specified position exceeds the positive software limit.				
Source	PLC Function Module		Source details	Instruction	Detection timing At instruction execution
Error attributes	Level	Observation	Recovery	---	Log category System
Effects	User program	Continues.	Operation	The relevant instruction will end according to specifications.	
System-defined variables	Variable		Data type		Name
	_MC_AX[*].MFaultLvl.Active		BOOL		Axis Minor Fault Occurrence
	_MC_GRP[*].MFaultLvl.Active		BOOL		Axes Group Minor Fault Occurrence
Cause and correction	Assumed cause		Correction		Prevention
	The parameter specified for the <i>Position</i> input variable to the instruction is beyond the positive software limit.		Correct the parameter specified for the <i>Position</i> input variable to the instruction so that it is within the positive software limit.		Set the parameter specified for the <i>Position</i> input variable to the instruction so that it is within the positive software limit.
	The starting position is beyond the positive software limit and an instruction that specifies motion in the opposite direction of the software limit was executed.		Correct the program so that the travel direction for the instruction is towards the positive software limit.		If the starting position is beyond the positive software limit, write the program so that the travel direction is in the direction of the positive software limit.
	The parameter that was specified for the <i>AuxPoint</i> input variable to a border point MC_MoveCircular2D (Circular 2D Interpolation) instruction is beyond the positive software limit.		Correct the parameter specified for the <i>AuxPoint</i> input variable to the instruction so that it is within the positive software limit.		Set the parameter specified for the <i>AuxPoint</i> input variable to the border point MC_MoveCircular2D (Circular 2D Interpolation) instruction so that it is within the negative software limit.
Attached information	Attached Information 1: Error Location Attached Information 3: Names of the Instruction and Instruction Instance Where the Error Occurred. If there is more than one possible instruction, information is given on all of them. Nothing is given if the instruction cannot be identified.				
Precautions/Remarks	If a program is changed after an error occurs, the attached information that is displayed may not be correct.				

Event name	Target Position Negative Software Limit Exceeded		Event code	54016441 hex	
Meaning	The specified position exceeds the negative software limit.				
Source	PLC Function Module		Source details	Instruction	Detection timing At instruction execution
Error attributes	Level	Observation	Recovery	---	Log category System
Effects	User program	Continues.	Operation	The relevant instruction will end according to specifications.	
System-defined variables	Variable		Data type		Name
	_MC_AX[*].MFaultLvl.Active		BOOL		Axis Minor Fault Occurrence
	_MC_GRP[*].MFaultLvl.Active		BOOL		Axes Group Minor Fault Occurrence
Cause and correction	Assumed cause		Correction		Prevention
	The parameter specified for the <i>Position</i> input variable to the instruction is beyond the negative software limit.		Correct the parameter specified for the <i>Position</i> input variable to the instruction so that it is within the negative software limit.		Correct the input parameter specified for the <i>Position</i> input variable to the instruction so that it is within the negative software limit.
	The starting position is beyond the negative software limit and an instruction that specifies motion in the opposite direction of the software limit was executed.		Correct the program so that the travel direction for the instruction is towards the negative software limit.		If the starting position is beyond the negative software limit, write the program so that the travel direction is in the direction of the negative software limit.
	The parameter that was specified for the <i>AuxPoint</i> input variable to a border point MC_MoveCircular2D (Circular 2D Interpolation) instruction is beyond the negative software limit.		Correct the parameter specified for the <i>AuxPoint</i> input variable to the instruction so that it is within the negative software limit.		Set the parameter specified for the <i>AuxPoint</i> input variable to the border point MC_MoveCircular2D (Circular 2D Interpolation) instruction so that it is within the negative software limit.
Attached information	Attached Information 1: Error Location Attached Information 3: Names of the Instruction and Instruction Instance Where the Error Occurred. If there is more than one possible instruction, information is given on all of them. Nothing is given if the instruction cannot be identified.				
Precautions/Remarks	If a program is changed after an error occurs, the attached information that is displayed may not be correct.				

Event name	Command Position Overflow/Underflow		Event code	54016442 hex	
Meaning	Positioning, an instruction in the underflow/overflow direction, or an instruction for which the direction is not specified was executed when there was an underflow/overflow in the command position.				
Source	PLC Function Module		Source details	Instruction	Detection timing At instruction execution
Error attributes	Level	Observation	Recovery	---	Log category System
Effects	User program	Continues.	Operation	The relevant instruction will end according to specifications.	
System-defined variables	Variable	Data type		Name	
	_MC_AX[*].MFaultLvl.Active	BOOL		Axis Minor Fault Occurrence	
Cause and correction	Assumed cause		Correction		Prevention
	<p>One of the following was executed when there was a command position overflow/underflow.</p> <ul style="list-style-type: none"> • A positioning instruction • A continuous control instruction in the underflow/overflow direction • An instruction for which the direction is not specified (syncing or torque control) 		Execute an error reset and then clear the overflow/underflow state by executing homing or presetting the actual position.		Make sure that overflow or underflow does not occur.
Attached information	<p>Attached Information 1: Error Location</p> <p>Attached Information 3: Names of the Instruction and Instruction Instance Where the Error Occurred. If there is more than one possible instruction, information is given on all of them. Nothing is given if the instruction cannot be identified.</p>				
Precautions/Remarks	If a program is changed after an error occurs, the attached information that is displayed may not be correct.				

Event name	Positive Limit Input		Event code	54016443 hex	
Meaning	An instruction was executed for a motion in the positive direction when the positive limit input was ON.				
Source	PLC Function Module		Source details	Instruction	Detection timing At instruction execution
Error attributes	Level	Observation	Recovery	---	Log category System
Effects	User program	Continues.	Operation	The relevant instruction will end according to specifications.	
System-defined variables	Variable		Data type		Name
	_MC_AX[*].MFAultLvl.Active		BOOL		Axis Minor Fault Occurrence
	_MC_GRP[*].MFAultLvl.Active		BOOL		Axes Group Minor Fault Occurrence
Cause and correction	Assumed cause		Correction		Prevention
	An instruction for a motion in the positive direction was executed when the positive limit input was ON, or an instruction for a motion with no direction specification was executed when the positive limit input was ON. An axes group motion control instruction was executed when the positive limit input was ON.		Execute an error reset and then perform a recovery operation in the negative direction. If the error occurred during an axes group motion control instruction, disable the axes group and then perform the above operation. If this error occurs again, check the connection of the positive limit signal, the logic setting for the positive limit input, and the execution conditions for the start command, and correct any mistakes. Check the logic settings both in the axis parameters and in the slave settings.		Check to make sure there are no problems with the positive limit signal connection, the logic setting for the positive limit input, and the execute conditions for the instruction. Check the logic settings both in the axis parameters and in the slave settings.
Attached information	Attached Information 1: Error Location Attached Information 3: Names of the Instruction and Instruction Instance Where the Error Occurred. If there is more than one possible instruction, information is given on all of them. Nothing is given if the instruction cannot be identified.				
Precautions/Remarks	If a program is changed after an error occurs, the attached information that is displayed may not be correct.				

Event name	Negative Limit Input		Event code	54016444 hex	
Meaning	An instruction for a motion in the negative direction was executed when the negative limit input was ON.				
Source	PLC Function Module		Source details	Instruction	Detection timing At instruction execution
Error attributes	Level	Observation	Recovery	---	Log category System
Effects	User program	Continues.	Operation	The relevant instruction will end according to specifications.	
System-defined variables	Variable		Data type		Name
	_MC_AX[*].MFaultLvl.Active		BOOL		Axis Minor Fault Occurrence
	_MC_GRP[*].MFaultLvl.Active		BOOL		Axes Group Minor Fault Occurrence
Cause and correction	Assumed cause		Correction		Prevention
	An instruction for a motion in the negative direction was executed when the negative limit input was ON, or an instruction for a motion with no direction specification was executed when the negative limit input was ON. An axes group motion control instruction was executed when the negative limit input was ON.		Execute an error reset and then perform a recovery operation in the positive direction. If the error occurred during an axes group motion control instruction, disable the axes group and then perform the above operation. If this error occurs again, check the connection of the negative limit signal, the logic setting for the negative limit input, and the execution conditions for the start command, and correct any mistakes. Check the logic settings both in the axis parameters and in the slave settings.		Check to make sure there are no problems with the negative limit signal connection, the logic setting for the negative limit input, and the execute conditions for the instruction. Check the logic settings both in the axis parameters and in the slave settings.
Attached information	Attached Information 1: Error Location Attached Information 3: Names of the Instruction and Instruction Instance Where the Error Occurred. If there is more than one possible instruction, information is given on all of them. Nothing is given if the instruction cannot be identified.				
Precautions/Remarks	If a program is changed after an error occurs, the attached information that is displayed may not be correct.				

Event name	Servo Main Circuits OFF		Event code	54017422 hex	
Meaning	An attempt was made to turn ON the Servo when the main circuit power supply to the Servo Drive was OFF.				
Source	PLC Function Module		Source details	Instruction	Detection timing At instruction execution
Error attributes	Level	Observation	Recovery	---	Log category System
Effects	User program	Continues.	Operation	The relevant instruction will end according to specifications.	
System-defined variables	Variable	Data type		Name	
	_MC_AX[*].MFaultLvl.Active	BOOL		Axis Minor Fault Occurrence	
Cause and correction	Assumed cause		Correction		Prevention
	An attempt was made to turn ON the Servo when the main circuit power supply to the Servo Drive was OFF.		Turn ON the Servo after turning ON the main circuit power of the Servo Drive for the axis where the error occurred.		Turn ON the Servo after turning ON the main circuit power supply to the Servo Drive.
Attached information	Attached Information 1: Error Location Attached Information 3: Names of the Instruction and Instruction Instance Where the Error Occurred. If there is more than one possible instruction, information is given on all of them. Nothing is given if the instruction cannot be identified.				
Precautions/Remarks	If a program is changed after an error occurs, the attached information that is displayed may not be correct.				

3-2-3 Other Troubles and Corrections

Security Errors

No.	Problem	Correction
1	Forgot the Administrator password.	You cannot access the Administrator's password. Always record the Administrator password so that you do not forget it.
2	Cannot release the operation lock with the Sysmac Studio.	Log in with verification authority that is equal to or higher than the verification rights when you connected online.
3	Operation was locked when verifying operation authority on the Sysmac Studio.	If the password for verification of operation authority is entered incorrectly five times in row, operation is locked for 10 minutes. Wait until the operation lock is released.
4	An online connection was made with the operation authority that is required for operation, but operation authority verification was requested for a specific operation.	Verification of operation authority is required every time for the following functions to prevent hazards to equipment and people. <ul style="list-style-type: none"> • I/O monitoring (writing) by an Operator • Operating mode change by a Maintainer • Online editing by a Maintainer
5	Cannot release the operation lock with the Sysmac Studio after the operator left the Sysmac Studio unattended.	You can release the operation lock with an operation authority that is equal to or higher than the operator. The required operation authority will be that of an operator (the operation authority that was verified when going online with the Sysmac Studio).
6	Some of the user program data cannot be read for certain operations. <ul style="list-style-type: none"> • Monitoring Variables • Operation Commands SET/RESET, forced refreshing, online editing, data tracing, MC Test Run, and setting the user program execution ID in the CPU Unit • Synchronizing, Uploading, Verification, and Backup POU algorithms 	The source data was not downloaded along with the user program. You will be able to read the data if you download the user program normally.
7	Writing to the CPU Unit is not possible for some operations. <ul style="list-style-type: none"> • Names CPU Unit name • Operation Commands Online editing, Clear All Memory, event log clearing, and setting the user program execution ID in the CPU Unit • Synchronizing and Downloading User program, CPU/Expansion Rack Configuration and Setup, EtherCAT Settings, Controller Setup, Axis Settings, Cam Table Settings, Data Trace Settings, User-defined Event Setup, restoring 	The CPU Unit is write protected. Release the write protection.

No.	Problem	Correction
8	I do not know how to change the user program execution ID.	The user program execution ID cannot be changed or deleted after it is set.
9	I forgot the user program execution ID assigned to user program.	This is no way to access the user program execution ID that is set. Always record the user program execution ID so that you do not forget it.
10	I forgot the user program execution ID that is registered in the CPU Unit.	This is no way to access the user program execution ID that is set. Set the user program execution ID again. You can also clear the user program execution ID in the CPU Unit if you execute the Clear All Memory operation.

3-3 Errors in the NX Bus Function Module

The section provides tables of the errors (events) that can occur in the NX Bus Function Module.

3-3-1 Error Tables

NX Bus

With the NX102 CPU Unit and NX1P2 CPU Unit, two or more events with more specific names may correspond to one Slave Terminal event. Refer to *A-7 Correspondence of NX Bus Events between NX102 CPU Units, NX1P2 CPU Units and Slave Terminals* on page A-305 for details.

Event code	Event name	Meaning	Assumed cause	Level					Reference
				M a j	P r t	M i n	O b s	I n f o	
04100000 hex [NX102, NX1P2]	NX Bus Controller Error	An error occurred in the NX bus.	<ul style="list-style-type: none"> An I/O communications error occurred between the CPU Unit and the NX Unit. 		○				page 3-436
04110000 hex [NX102, NX1P2]	NX Bus Hardware Error	A hardware error was detected in the NX Bus Function Module.	<ul style="list-style-type: none"> A hardware error related to the NX bus was detected. 		○				page 3-437
10600000 hex [NX102, NX1P2]	NX Bus Memory Check Error	An error was detect- ed in the internal memory check for the NX Bus Function Module.	<ul style="list-style-type: none"> An error was detected in the memory check for the internal protection circuit. 		○				page 3-437
10610000 hex [NX102, NX1P2]	Failed to Read NX Unit Opera- tion Settings	Reading the NX Unit operation settings failed. Cycle the power sup- ply to the CPU Unit to restore the previous normally-saved set- tings.	<ul style="list-style-type: none"> The NX Unit operation settings are not saved normally in the CPU Unit. 		○				page 3-438
24D00000 hex [NX102, NX1P2]	Number of Mountable NX Units Ex- ceeded	The number of mounted NX Units exceeds the specified value for the CPU Unit.	More than the maximum number of NX Units are mounted on the CPU Unit.		○				page 3-439
24D20000 hex [NX102, NX1P2]	Total I/O Da- ta Size in NX Units Exces- sive	The total size of I/O data in the mounted NX Units exceeds the maximum specified value for the CPU Unit.	<ul style="list-style-type: none"> The total size of I/O data in the mounted NX Units exceeds the maximum specified value for the CPU Unit. 		○				page 3-440
356D0000 hex (Ver. 1.40 or later)	Parameters Not Trans- ferred	NX Unit parameters are not transferred.	NX Unit parameters are not transferred.		○				page 3-440

Event code	Event name	Meaning	Assumed cause	Level					Reference
				M a j	P r t	M i n	O b s	I n f o	
35900000 hex [NX102, NX1P2]	NX Unit Ver- sion Not Matched	There is a mounted NX Unit with a unit version earlier than that in the Unit config- uration information registered in the CPU Unit.	The unit version of an NX Unit mounted in the actual configura- tion is earlier than that in the Unit configuration information regis- tered in the CPU Unit.		○				page 3-441
35910000 hex [NX102, NX1P2]	Unregistered NX Unit Mounted	There is a mounted NX Unit that does not exist in the Unit con- figuration information registered in the CPU Unit. If there are more than one NX Unit rel- evant to this event, only the NX Unit that is nearest to the CPU Unit is registered with the event.	<ul style="list-style-type: none"> There is a mounted Unit that does not exist in the Unit con- figuration information regis- tered in the CPU Unit. There is a mounted Unit in which the NX Unit Mounting Setting is set to <i>Disabled</i>. 		○				page 3-442
35930000 hex [NX102, NX1P2]	NX Unit Se- rial Number Mismatch	There is a mounted NX Unit with a serial number different from that in the Unit config- uration information registered in the CPU Unit.	<ul style="list-style-type: none"> One or more NX Units with the serial number set in the Unit configuration information regis- tered in the CPU Unit are not mounted. 		○				page 3-443
44440000 hex [NX102, NX1P2]	NX Bus Function Processing Error	A fatal error was de- tected in the NX Bus Function Module.	An error occurred in the software.		○				page 3-444
85540000 hex [NX102, NX1P2]	NX Bus I/O Communica- tions Stop- ped Due to Another Event	The I/O communica- tions on the NX bus were stopped be- cause an error that prevents I/O commu- nications on the NX bus occurred.	<ul style="list-style-type: none"> The I/O refreshing was stop- ped because a minor fault er- ror (another event) that trig- gers fail-soft operation occur- red when the Fail-soft Opera- tion Setting is <i>Stop</i>. The I/O communications was stopped because the <i>Registered NX Unit Not Mounted</i> event occurred and the actual configuration pre- vents I/O communications from starting. 		○				page 3-444

Event code	Event name	Meaning	Assumed cause	Level					Reference
				M a j	P r t	M i n	O b s	I n f o	
35920000 hex [NX102, NX1P2]	Registered NX Unit Not Mounted	One or more NX Units set in the Unit configuration information registered in the CPU Unit are not mounted. If there are more than one NX Unit relevant to this event, only the NX Unit that is nearest to the CPU Unit is registered with the event.	<ul style="list-style-type: none"> There is no mounted NX Unit that exists in the Unit configuration information registered in the CPU Unit. The power supply to the Additional NX Unit Power Supply Unit is not turned ON. 			○			page 3-445
85500000 hex [NX102, NX1P2]	NX Bus Communica- tions Error	A communications error that prevents normal NX bus communications was detected. If there are more than one NX Unit relevant to this event, only the NX Unit that is nearest to the CPU Unit is registered with the event.	<ul style="list-style-type: none"> The NX bus connector contact is faulty due to vibration or shock. Excessive noise is applied to the NX bus connector. An NX Unit was removed. An error occurred in an NX Unit. 			○			page 3-446
85510000 hex [NX102, NX1P2]	NX Unit Communica- tions Time- out	An error occurred in I/O data communications with the NX Units.	<ul style="list-style-type: none"> An NX Bus Communications Error has occurred. An error occurred in an NX Unit. 			○			page 3-446
85520000 hex [NX102, NX1P2]	NX Unit Ini- tialization Er- ror	Initializing an NX Unit failed.	<ul style="list-style-type: none"> Initialization with the Unit configuration information registered in the CPU Unit failed. An NX Bus Communications Error has occurred. The Channel Enable/Disable Setting for all channels of the Analog Unit are set to Disable. Initialization of an NX Unit failed. 			○			page 3-447
85530000 hex [NX102, NX1P2]	NX Unit Startup Error	Starting an NX Unit failed.	A startup error occurred in an NX Unit.			○			page 3-448
103C0000 hex [NX102, NX1P2]	NX Unit Backup Failed	The backup operation for an NX Unit ended in an error.	<ul style="list-style-type: none"> There is also another error related to the NX Bus Function Module. An NX Bus Communications Error has occurred. Backup data cannot be received from an NX Unit. 				○		page 3-448

Event code	Event name	Meaning	Assumed cause	Level					Reference
				M a j	P r t	M i n	O b s	I n f o	
103D0000 hex [NX102, NX1P2]	NX Unit Restore Operation Failed	The restore operation for an NX Unit ended in an error.	<ul style="list-style-type: none"> There is also another error related to the NX Bus Function Module. An NX Bus Communications Error has occurred. The backup data cannot be sent to an NX Unit. The Unit configuration in the backup file does not agree with the actual Unit configuration. 				○		page 3-449
10620000 hex [NX102, NX1P2]	NX Unit Event Log Save Error	Saving or reading the NX Unit event log failed. Continuing to operate with this error may result in no event log saved at CPU Unit power OFF although it has no effect on the control function.	<ul style="list-style-type: none"> Data in the NX Unit event log area are invalid. 				○		page 3-450
44450000 hex [NX102, NX1P2]	NX Bus System Information	This event provides internal information from the NX Bus Function Module.	<ul style="list-style-type: none"> This event provides internal information from the NX Bus Function Module. 					○	page 3-450
95800000 hex [NX102, NX1P2]	NX Bus Restart Executed	An NX bus restart was executed.	An NX bus restart command was received.					○	page 3-451
95810000 hex [NX102, NX1P2]	NX Unit Memory All Cleared	The NX Unit operation settings were initialized.	A Clear All Memory operation for an NX Unit was received.					○	page 3-452

3-3-2 Error Descriptions

NX Bus

Event name	NX Bus Controller Error		Event code	04100000 hex	
Meaning	An error occurred in the NX bus.				
Source	NX Bus Function Module		Source details	Master	Detection timing At CPU Unit power ON, at Controller reset, or during NX bus communications
Error attributes	Level	Partial fault	Recovery	Cycle the power supply to the CPU Unit or reset the Controller.	Log category System
Effects	User program	Continues.	Operation	I/O communications will not operate and message communications cannot be performed.	
System-defined variables	Variable	Data type		Name	
	None	---		---	
Cause and correction	Assumed cause		Correction		Prevention
	An I/O communications error occurred between the CPU Unit and the NX Unit.		Cycle the power supply to the CPU Unit. If this error persists, replace the CPU Unit.		None
Attached information	Attached information 1: System information				
Precautions/Remarks	None				

Event name	NX Bus Hardware Error		Event code	04110000 hex	
Meaning	A hardware error was detected in the NX Bus Function Module.				
Source	NX Bus Function Module		Source details	Master	Detection timing Continuously
Error attributes	Level	Partial fault	Recovery	Cycle the power supply to the CPU Unit or reset the Controller.	Log category System
Effects	User program	Continues.	Operation	I/O communications will not operate and message communications cannot be performed.	
System-defined variables	Variable		Data type		Name
	None		---		---
Cause and correction	Assumed cause		Correction		Prevention
	A hardware error related to the NX bus was detected.		Cycle the power supply to the CPU Unit. If this error persists, replace the CPU Unit.		None
Attached information	Attached information 1: System information Attached information 2: System information Attached information 3: System information Attached information 4: System information				
Precautions/Remarks	None				

Event name	NX Bus Memory Check Error		Event code	10600000 hex	
Meaning	An error was detected in the internal memory check for the NX Bus Function Module.				
Source	NX Bus Function Module		Source details	Master	Detection timing Continuously
Error attributes	Level	Partial fault	Recovery	Cycle the power supply to the CPU Unit or reset the Controller.	Log category System
Effects	User program	Continues.	Operation	I/O communications will not operate and message communications cannot be performed.	
System-defined variables	Variable		Data type		Name
	None		---		---
Cause and correction	Assumed cause		Correction		Prevention
	An error was detected in the memory check for the internal protection circuit.		Cycle the power supply to the CPU Unit. If this error persists, replace the CPU Unit.		None
Attached information	Attached information 1: System information				
Precautions/Remarks	None				

Event name	Failed to Read NX Unit Operation Settings		Event code	10610000 hex	
Meaning	Reading the NX Unit operation settings failed. Cycle the power supply to the CPU Unit to restore the previous normally-saved settings.				
Source	NX Bus Function Module		Source details	Master	Detection timing At CPU Unit power ON, at Controller reset, or at NX bus restart
Error attributes	Level	Partial fault	Recovery	Cycle the power supply to the CPU Unit, reset the Controller, or restart the NX bus.	Log category System
Effects	User program	Continues.	Operation	I/O communications will not operate, but message communications can be performed.	
System-defined variables	Variable	Data type		Name	
	None	---		---	
Cause and correction	Assumed cause	Correction		Prevention	
	The NX Unit operation settings are not saved normally in the CPU Unit.	Check the NX Unit operation settings and correct the settings.		Do not turn OFF the power supply to the CPU Unit while transfer of the Unit operation settings for the CPU Unit or execution of the NX_SaveParam instruction is in progress.	
Attached information	Attached information 1: System information				
Precautions/Remarks	None				

Event name	Number of Mountable NX Units Exceeded		Event code	24D00000 hex	
Meaning	The number of mounted NX Units exceeds the specified value for the CPU Unit.				
Source	NX Bus Function Module		Source details	Master	Detection timing At CPU Unit power ON, at Controller reset, or at NX bus restart
Error attributes	Level	Partial fault	Recovery	Cycle the power supply to the CPU Unit or reset the Controller.	Log category System
Effects	User program	Continues.	Operation	<ul style="list-style-type: none"> For NX Units within the range of the number of mountable Units, I/O communications will not operate, but message communications can be performed. For NX Units outside the range of the number of mountable Units, I/O communications will not operate and message communications cannot be performed. 	
System-defined variables	Variable	Data type		Name	
	None	---		---	
Cause and correction	Assumed cause		Correction		Prevention
	More than the maximum number of NX Units are mounted on the CPU Unit.		Keep the number of NX Units mounted on the CPU Unit at the specified number or less.		Mount the specified number of NX Units or less.
Attached information	None				
Precautions/Remarks	None				

Event name	Total I/O Data Size in NX Units Excessive		Event code	24D20000 hex		
Meaning	The total size of I/O data in the mounted NX Units exceeds the maximum specified value for the CPU Unit.					
Source	NX Bus Function Module		Source details	Master	Detection timing	At CPU Unit power ON, at Controller reset, or at NX bus re-start
Error attributes	Level	Partial fault	Recovery	Cycle the power supply to the CPU Unit or re-set the Controller.	Log category	System
Effects	User program	Continues.	Operation	I/O communications will not operate, but message communications can be performed.		
System-defined variables	Variable	Data type		Name		
	None	---		---		
Cause and correction	Assumed cause		Correction		Prevention	
	The total size of I/O data in the mounted NX Units exceeds the maximum specified value for the CPU Unit.		Reduce the number of NX Units mounted on the CPU Unit to keep the total size of I/O data at the maximum specified value or less.		Reduce the number of NX Units mounted on the CPU Unit to keep the total size of I/O data at the maximum specified value or less.	
Attached information	None					
Precautions/Remarks	None					

Event name	Parameters Not Transferred		Event code	356D0000 hex *1		
Meaning	NX Unit parameters are not transferred.					
Source	NX Bus Function Module		Source details	Master	Detection timing	At power ON, Controller reset, or operating mode change
Error attributes	Level	Partial fault	Recovery	Cycle the power supply to the CPU Unit or re-set the Controller.	Log category	System
Effects	User program	Continues.	Operation	I/O communications will not operate, but message communications can be performed.		
System-defined variables	Variable	Data type		Name		
	None	---		---		
Cause and correction	Assumed cause		Correction		Prevention	
	NX Unit parameters are not transferred.		Cycle the power supply or reset the Controller after you transfer NX Unit parameters from the Sysmac Studio.		If you execute the download that is required to reset the Controller, you need to transfer NX Unit parameters. Download the data according to the message displayed on the Sysmac Studio.	
Attached information	None					
Precautions/Remarks	None					

*1. This event code occurs for unit version 1.40 or later of the CPU Unit.

Event name	NX Unit Version Not Matched		Event code	35900000 hex	
Meaning	There is a mounted NX Unit with a unit version earlier than that in the Unit configuration information registered in the CPU Unit.				
Source	NX Bus Function Module		Source details	Master	Detection timing At CPU Unit power ON, at Controller reset, or at NX bus restart
Error attributes	Level	Partial fault	Recovery	Cycle the power supply to the CPU Unit, reset the Controller, or restart the NX bus.	Log category System
Effects	User program	Continues.	Operation	<ul style="list-style-type: none"> For NX Units with this error, I/O communications will not operate and message communications cannot be performed. For NX Units without this error, I/O communications will not operate, but message communications can be performed. 	
System-defined variables	Variable	Data type		Name	
	None	---		---	
Cause and correction	Assumed cause		Correction		Prevention
	The unit version of an NX Unit mounted in the actual configuration is earlier than that in the Unit configuration information registered in the CPU Unit.		To match the Unit configuration information with the actual configuration, download the Unit configuration information that contains the unit version of the NX Unit mounted in the actual configuration to the CPU Unit. To match the actual configuration with the Unit configuration information, replace the NX Unit in the actual configuration with an NX Unit with a unit version later than that in the Unit configuration information.		Download Unit configuration information for which you confirmed that the comparison result showed <i>Not compatible</i> in the Compare and Merge Window of the Sysmac Studio to the CPU Unit.
Attached information	Attached information 1: Unit number of the NX Unit where the error occurred Attached information 2: Unit version in the Unit configuration information of the NX Unit where the error occurred				
Precautions/Remarks	None				

Event name	Unregistered NX Unit Mounted		Event code	35910000 hex		
Meaning	There is a mounted NX Unit that does not exist in the Unit configuration information registered in the CPU Unit. If there are more than one NX Unit relevant to this event, only the NX Unit that is nearest to the CPU Unit is registered with the event.					
Source	NX Bus Function Module		Source details	Master	Detection timing	At CPU Unit power ON, at Controller reset, or at NX bus restart
Error attributes	Level	Partial fault	Recovery	Cycle the power supply to the CPU Unit, reset the Controller, or restart the NX bus.	Log category	System
Effects	User program	Continues.	Operation	<ul style="list-style-type: none"> For NX Units with this error, I/O communications will not operate and message communications cannot be performed. For NX Units without this error, I/O communications will not operate, but message communications can be performed. 		
System-defined variables	Variable	Data type		Name		
	None	---		---		
Cause and correction	Assumed cause		Correction		Prevention	
	There is a mounted Unit that does not exist in the Unit configuration information registered in the CPU Unit.		To match the Unit configuration information with the actual configuration, download to the CPU Unit the Unit configuration information to which you added the relevant NX Unit. To match the actual configuration with the Unit configuration information, remove the relevant NX Unit.		Match the project downloaded to the CPU Unit with the system configuration.	
	There is a mounted Unit in which the NX Unit Mounting Setting is set to <i>Disabled</i> .		To match the Unit configuration information with the actual configuration, download to the CPU Unit the Unit configuration information in which the NX Unit Mounting Setting for the relevant NX Unit is set to <i>Enabled</i> . To match the actual configuration with the Unit configuration information, remove the relevant NX Unit.			
Attached information	Attached information 1: Mounting position of the NX Unit where the error occurred					
Precautions/Remarks	None					

Event name	NX Unit Serial Number Mismatch		Event code	35930000 hex	
Meaning	There is a mounted NX Unit with a serial number different from that in the Unit configuration information registered in the CPU Unit.				
Source	NX Bus Function Module		Source details	Master	Detection timing At CPU Unit power ON, at Controller reset, or at NX bus restart
Error attributes	Level	Partial fault	Recovery	Cycle the power supply to the CPU Unit, reset the Controller, or restart the NX bus.	Log category System
Effects	User program	Continues.	Operation	<ul style="list-style-type: none"> For NX Units with this error, I/O communications will not operate and message communications cannot be performed. For NX Units without this error, I/O communications will not operate, but message communications can be performed. 	
System-defined variables	Variable	Data type		Name	
	None	---		---	
Cause and correction	Assumed cause		Correction		Prevention
	One or more NX Units with the serial number set in the Unit configuration information registered in the CPU Unit are not mounted.		To match the actual configuration with the Unit configuration information, match the serial number of the relevant NX Unit. To match the Unit configuration information with the actual configuration, download the Unit configuration information with the serial number of the relevant NX Unit to the CPU Unit.		Read the serial numbers of the actually mounted Units into a project in the Sysmac Studio before you set the Serial Number Verification setting to verify the serial numbers.
Attached information	Attached information 1: Unit number of the NX Unit where the error occurred Attached information 2: Serial number in the Unit configuration information of the NX Unit where the error occurred				
Precautions/Remarks	None				

3 Error Descriptions and Corrections

Event name	NX Bus Function Processing Error		Event code	44440000 hex	
Meaning	A fatal error was detected in the NX Bus Function Module.				
Source	NX Bus Function Module		Source details	Master	Detection timing Continuously
Error attributes	Level	Partial fault	Recovery	Cycle the power supply to the CPU Unit.	Log category System
Effects	User program	Continues.	Operation	I/O communications will not operate and message communications cannot be performed.	
System-defined variables	Variable	Data type		Name	
	None	---		---	
Cause and correction	Assumed cause		Correction		Prevention
	An error occurred in the software.		Contact your OMRON representative.		None
Attached information	Attached information 1: System information Attached information 2: System information Attached information 3: System information Attached information 4: System information				
Precautions/Remarks	None				

Event name	NX Bus I/O Communications Stopped Due to Another Event		Event code	85540000 hex	
Meaning	The I/O communications on the NX bus were stopped because an error that prevents I/O communications on the NX bus occurred.				
Source	NX Bus Function Module		Source details	Master	Detection timing Continuously
Error attributes	Level	Partial fault	Recovery	Error reset	Log category System
Effects	User program	Continues.	Operation	I/O communications will not operate, but message communications can be performed.	
System-defined variables	Variable	Data type		Name	
	None	---		---	
Cause and correction	Assumed cause		Correction		Prevention
	The I/O communications were stopped because a minor fault error (another event) that triggers fail-soft operation occurred when the Fail-soft Operation Setting is <i>Stop</i> .		Eliminate errors for other events that causes this event.		To continue the I/O communications when an error that triggers fail-soft operation is encountered, change the Fail-soft Operation Setting to <i>Fail-soft</i> .
	The I/O communications were stopped because the <i>Registered NX Unit Not Mounted</i> event occurred and the actual configuration prevents I/O communications from starting.				
Attached information	Attached information 1: Event code that caused this event Attached information 2: System information				
Precautions/Remarks	None				

Event name	Registered NX Unit Not Mounted		Event code	35920000 hex		
Meaning	One or more NX Units set in the Unit configuration information registered in the CPU Unit are not mounted. If there are more than one NX Unit relevant to this event, only the NX Unit that is nearest to the CPU Unit is registered with the event.					
Source	NX Bus Function Module		Source details	Master	Detection timing	At CPU Unit power ON, at Controller reset, or at NX bus re-start
Error attributes	Level	Minor fault	Recovery	Cycle the power supply to the CPU Unit, reset the Controller, or restart the NX bus.	Log category	System
Effects	User program	Continues.	Operation	For NX Units with this error, I/O communications will not operate and message communications cannot be performed.		
System-defined variables	Variable	Data type		Name		
	None	---		---		
Cause and correction	Assumed cause		Correction		Prevention	
	One or more NX Units set in the Unit configuration information registered in the CPU Unit are not mounted.		To match the actual configuration with the Unit configuration information, mount the relevant NX Unit. To match the Unit configuration information with the actual configuration, download to the CPU Unit the Unit configuration information from which you deleted the relevant NX Unit.		Match the project downloaded to the CPU Unit with the system configuration.	
	The power supply to the Additional NX Unit Power Supply Unit is not turned ON.		Turn ON the power supply to the Additional NX Unit Power Supply Unit.		Use the same Unit power supply to supply the Unit power to the CPU Rack.	
Attached information	Attached information 1: Unit number of the NX Unit where the error occurred					
Precautions/Remarks	None					

3 Error Descriptions and Corrections

Event name	NX Bus Communications Error		Event code	85500000 hex		
Meaning	A communications error that prevents normal NX bus communications was detected. If there are more than one NX Unit relevant to this event, only the NX Unit that is nearest to the CPU Unit is registered with the event.					
Source	NX Bus Function Module		Source details	Master	Detection timing	Continuously
Error attributes	Level	Minor fault	Recovery	Cycle the power supply to the CPU Unit, reset the Controller, or restart the NX bus.	Log category	System
Effects	User program	Continues.	Operation	For NX Units located outside the NX Unit where an error occurred, I/O communications will not operate and message communications cannot be performed.		
System-defined variables	Variable	Data type		Name		
	None	---		---		
Cause and correction	Assumed cause		Correction		Prevention	
	The NX bus connector contact is faulty due to vibration or shock.		Mount the NX Units and End Cover securely and secure them with End Plates.		Perform installation according to the user's manual	
	Excessive noise is applied to the NX bus connector.		Implement noise countermeasures according to the user's manual.			
	An NX Unit was removed.		Mount the removed NX Unit again.			
	An error occurred in an NX Unit.		Cycle the power supply to the relevant NX Unit. If this error persists, replace the NX Unit.		None	
Attached information	Attached information 1: Unit number of the NX Unit where the error occurred					
Precautions/Remarks	None					

Event name	NX Unit Communications Timeout		Event code	85510000 hex		
Meaning	An error occurred in I/O data communications with the NX Units.					
Source	NX Bus Function Module		Source details	Master	Detection timing	Continuously
Error attributes	Level	Minor fault	Recovery	Error reset	Log category	System
Effects	User program	Continues.	Operation	For NX Units with this error, I/O communications will not operate, but message communications can be performed.		
System-defined variables	Variable	Data type		Name		
	None	---		---		
Cause and correction	Assumed cause		Correction		Prevention	
	An NX Bus Communications Error has occurred.		Correct the NX Bus Communications Error.		Take preventive measures against the NX Bus Communications Error.	
	An error occurred in an NX Unit.		Cycle the power supply to the relevant NX Unit. If this error persists, replace the NX Unit.			
Attached information	Attached information 1: Unit number of the NX Unit where the error occurred Attached information 2: System information					
Precautions/Remarks	None					

Event name	NX Unit Initialization Error		Event code	85520000 hex	
Meaning	Initializing an NX Unit failed.				
Source	NX Bus Function Module		Source details	Master	Detection timing At CPU Unit power ON, at Controller reset, at NX bus restart, or at error reset
Error attributes	Level	Minor fault	Recovery	Error reset	Log category System
Effects	User program	Continues.	Operation	For NX Units with this error, I/O communications will not operate, but message communications can be performed.	
System-defined variables	Variable	Data type		Name	
	None	---		---	
Cause and correction	Assumed cause	Correction		Prevention	
	Initialization with the Unit configuration information registered in the CPU Unit failed.	Connect the Sysmac Studio and reconfigure the Unit configuration information in the CPU Unit.		Download the Unit configuration information to the CPU Unit and the NX Unit.	
	An NX Bus Communications Error has occurred.	Correct the NX Bus Communications Error.		Take preventive measures against the NX Bus Communications Error.	
	The Channel Enable/Disable Setting for all channels of the Analog Unit are set to <i>Disable</i> .	Set the Channel Enable/Disable Setting to <i>Enable</i> for at least one channel.		For an Analog Unit, set the Channel Enable/Disable Setting to <i>Enable</i> for at least one channel.	
	Initialization of an NX Unit failed.	Cycle the power supply to the relevant NX Unit. If this error persists, replace the NX Unit.		For an Analog Unit, set the Channel Enable/Disable Setting to <i>Enable</i> for at least one channel.	
Attached information	Attached information 1: Unit number of the NX Unit where the error occurred Attached information 2: System information				
Precautions/Remarks	None				

Event name	NX Unit Startup Error		Event code	85530000 hex	
Meaning	Starting an NX Unit failed.				
Source	NX Bus Function Module		Source details	Master	Detection timing At CPU Unit power ON, at Controller reset, at NX bus re-start, or at error reset
Error attributes	Level	Minor fault	Recovery	Cycle the power supply to the CPU Unit or re-set the Controller.	Log category System
Effects	User program	Continues.	Operation	For NX Units with this error, I/O communications will not operate and message communications cannot be performed.	
System-defined variables	Variable	Data type		Name	
	None	---		---	
Cause and correction	Assumed cause		Correction		Prevention
	A startup error occurred in an NX Unit.		Cycle the power supply to the relevant NX Unit. If this error persists, replace the NX Unit.		None
Attached information	Attached information 1: Mounting position of the NX Unit where the error occurred Attached information 2: System information				
Precautions/Remarks	None				

Event name	NX Unit Backup Failed		Event code	103C0000 hex	
Meaning	The backup operation for an NX Unit ended in an error.				
Source	NX Bus Function Module		Source details	Master	Detection timing When backup is executed
Error attributes	Level	Observation	Recovery	---	Log category System
Effects	User program	Continues.	Operation	Not affected.	
System-defined variables	Variable	Data type		Name	
	None	---		---	
Cause and correction	Assumed cause		Correction		Prevention
	There is also another error related to the NX Bus Function Module.		Check errors related to the NX Bus Function Module and perform the required corrections.		Back up the data when there are no NX bus errors.
	An NX Bus Communications Error has occurred.		Implement countermeasures against the NX Bus Communications Error.		
	Backup data cannot be received from an NX Unit.		Reset the error for the relevant NX Unit.		
Attached information	Attached Information 1: Error Location <ul style="list-style-type: none"> • 0: NX bus master • 1 or higher: Unit number of the NX Unit Attached Information 2: Cause of the error <ul style="list-style-type: none"> • 1: There is an error related to the NX Bus Function Module. • 2: Communications with an NX Unit failed. Attached information 3: System information				
Precautions/Remarks	None				

Event name	NX Unit Restore Operation Failed		Event code	103D0000 hex	
Meaning	The restore operation for an NX Unit ended in an error.				
Source	NX Bus Function Module		Source details	Master	Detection timing During restore operation
Error attributes	Level	Observation	Recovery	---	Log category System
Effects	User program	Continues.	Operation	Not affected.	
System-defined variables	Variable	Data type		Name	
	None	---		---	
Cause and correction	Assumed cause		Correction		Prevention
	There is also another error related to the NX Bus Function Module.		Check errors related to the NX Bus Function Module and perform the required corrections.		Restore the data when there are no NX bus errors.
	An NX Bus Communications Error has occurred.		Implement countermeasures against the NX Bus Communications Error.		
	The backup data cannot be sent to an NX Unit.		Reset the error for the relevant NX Unit.		
	The Unit configuration in the backup file does not agree with the actual Unit configuration.		Use an NX Unit revision that is the same or higher than the revision used when the data was backed up. If you replace a slave with the Serial Number Check Method set to <i>Setting = Actual device</i> , do not use the restore function. Instead, change the network configuration from the Sysmac Studio, download the network configuration, and then transfer the slave parameters.		
Attached information	<p>Attached Information 1: Error Location</p> <ul style="list-style-type: none"> • 0: NX bus master • 1 or higher: Unit number of the NX Unit <p>Attached Information 2: Cause of the error</p> <ul style="list-style-type: none"> • 1: There is an error related to the NX Bus Function Module. • 2: Communications with an NX Unit failed. • 3: The Unit configuration in the backup data does not agree with the actual Unit configuration. <p>Attached information 3: System information</p>				
Precautions/Remarks	None				

3 Error Descriptions and Corrections

Event name	NX Unit Event Log Save Error		Event code	10620000 hex		
Meaning	Saving or reading the NX Unit event log failed. Continuing to operate with this error may result in no event log saved at CPU Unit power OFF although it has no effect on the control function.					
Source	NX Bus Function Module		Source details	Master	Detection timing	At CPU Unit power ON or at Controller reset
Error attributes	Level	Observation	Recovery	---	Log category	System
Effects	User program	Continues.	Operation	Part or all of the past event log cannot be read.		
System-defined variables	Variable	Data type		Name		
	None	---		---		
Cause and correction	Assumed cause	Correction		Prevention		
	Data in the NX Unit event log area are invalid.	If this error persists even after you cycle the power supply to the CPU Unit, a hardware failure may occur in the NX Unit event log area. Replace the CPU Unit if you use the event logs in the CPU Unit.		None		
Attached information	Attached information 1: System information					
Precautions/Remarks	None					

Event name	NX Bus System Information		Event code	44450000 hex		
Meaning	This event provides internal information from the NX Bus Function Module.					
Source	NX Bus Function Module		Source details	Master	Detection timing	Continuously
Error attributes	Level	Information	Recovery	---	Log category	System
Effects	User program	Continues.	Operation	Not affected.		
System-defined variables	Variable	Data type		Name		
	None	---		---		
Cause and correction	Assumed cause	Correction		Prevention		
	This event provides internal information from the NX Bus Function Module.	---		---		
Attached information	Attached information 1: System information Attached information 2: System information Attached information 3: System information Attached information 4: System information					
Precautions/Remarks	None					

Event name	NX Bus Restart Executed		Event code	95800000 hex	
Meaning	An NX bus restart was executed.				
Source	NX Bus Function Module		Source details	Master	Detection timing At NX bus restart or at NX Unit restart
Error attributes	Level	Information	Recovery	---	Log category Access
Effects	User program	Continues.	Operation	Not affected.	
System-defined variables	Variable		Data type		Name
	_NXB_UnitIOActiveTbl		ARRAY [0..n] OF BOOL *1		NX Unit I/O Data Active Status
	_NXB_UnitMsgActiveTbl		ARRAY [0..n] OF BOOL *1		NX Unit Message Enabled Status
Cause and correction	Assumed cause		Correction		Prevention
	An NX bus restart command was received.		---		---
Attached information	<p>Attached information 1: Type of restart</p> <ul style="list-style-type: none"> • 0: The NX bus was restarted • 1: An NX Unit was restarted <p>Attached information 2: Unit number of the Unit that executed a restart</p> <ul style="list-style-type: none"> • 0: NX bus master • 1 or higher: NX Unit 				
Precautions/Remarks	None				

*1. n is 8 for NX1P2 CPU Units and 32 for NX102 CPU Units.

Event name	NX Unit Memory All Cleared		Event code	95810000 hex ^{*1}	
Description	The NX Unit operation settings were initialized.				
Source	NX Bus Function Module		Source details	Master	Detection timing When NX Unit memory is all cleared
Error attributes	Level	Information	Recovery	---	Log category Access
Effects	User program	Continues.	Operation	Not affected.	
System-defined variables	Variable	Data type		Name	
	_NXB_UnitIOActiveTbl	ARRAY [0..32] OF BOOL		NX Unit I/O Data Active Status	
	_NXB_UnitMsgActiveTbl	ARRAY [0..32] OF BOOL		NX Unit Message Communications Enabled Status	
Cause and correction	Assumed cause		Correction		Prevention
	A Clear All Memory operation for an NX Unit was received.		Make the Unit operation settings as necessary for the NX Unit for which you executed Clear All Memory operation. If the attached information 2 is not 0, check any minor fault or higher-level error that occurs in the NX Bus Function Module and the NX Unit, and make the required corrections.		---
Attached information	Attached information 1: Unit number of the NX Unit for which you executed Clear All Memory Attached information 2: Execution results of Clear All Memory operation <ul style="list-style-type: none"> • 0: All cleared • 1: Hardware error • 2: Initialization failure • 3: Initialization not possible 				
Precautions/Remarks	None				

*1. This event code occurs for a CPU Unit with unit version 1.18 or later.

3-4 Errors in the X Bus Function Module

This section describes the errors (events) that occur in the X Bus Function Module.

3-4-1 Error Tables

X Bus

Event code	Event name	Meaning	Assumed cause	Level					Reference
				M a j	P r t	M i n	O b s	I n f o	
15100000 hex [NX502]	X Bus Unit Configuration Setting Error	The X Bus Unit configuration setting saved in non-volatile memory has been lost.	<ul style="list-style-type: none"> The power supply to the Controller was interrupted or communications with the Sysmac Studio were disconnected while downloading the X Bus Unit configuration setting or clearing memory. Non-volatile memory failure 		○				page 3-455
24C00000 hex [NX502]	Number of Mountable X Bus Units Exceeded	The number of connected X Bus Units exceeds the specified value for the CPU Unit.	<ul style="list-style-type: none"> More than the maximum number of X Bus Units are connected. 		○				page 3-456
24C10000 hex [NX502]	Unsupported X Bus Unit Mounted	Unsupported X Bus Unit is mounted.	<ul style="list-style-type: none"> Unsupported X Bus Unit was detected. 		○				page 3-456
44300000 hex [NX502]	X Bus Function Processing Error	A fatal error was detected in the X Bus Function Module.	<ul style="list-style-type: none"> An error occurred in the software. 		○				page 3-457
35600000 hex [NX502]	X Bus Unit Version Not Matched	There is a mounted X Bus Unit with a unit version earlier than that in the Unit configuration information registered in the CPU Unit.	<ul style="list-style-type: none"> The unit version of an X Bus Unit mounted in the actual hardware configuration is earlier than that in the Unit configuration information registered in the CPU Unit. 			○			page 3-458
35610000 hex [NX502]	Unregistered X Bus Unit Mounted	There is a mounted X Bus Unit that does not exist in the Unit configuration information registered in the CPU Unit. An event is registered for every applicable X Bus Unit.	<ul style="list-style-type: none"> There is a mounted Unit that does not exist in the Unit configuration information registered in the CPU Unit. There is a mounted Unit in which the X Bus Unit Mounting Setting is set to <i>Disabled</i>. 			○			page 3-459

Event code	Event name	Meaning	Assumed cause	Level					Reference
				M a j	P r t	M i n	O b s	I n f o	
35620000 hex [NX502]	Registered X Bus Unit Not Mounted	One or more X Bus Units set in the Unit configuration information registered in the CPU Unit are not mounted. An event is registered for every applicable X Bus Unit.	<ul style="list-style-type: none"> One or more X Bus Units set in the Unit configuration information registered in the CPU Unit are not mounted. 			○			page 3-460
35630000 hex [NX502]	X Bus Unit Serial Number Mismatch	There is a mounted X Bus Unit with a serial number different from that in the Unit configuration information registered in the CPU Unit.	<ul style="list-style-type: none"> One or more X Bus Units with the serial number set in the Unit configuration information registered in the CPU Unit are not mounted. 			○			page 3-461
85A00000 hex [NX502]	X Bus Unit Startup Error	Starting an X Bus Unit failed.	<ul style="list-style-type: none"> A startup error occurred in an X Bus Unit. 			○			page 3-462
85A10000 hex [NX502]	X Bus Unit Communications Error	A communications error that prevents normal X Bus communications was detected. An event is registered for every applicable X Bus Unit.	<ul style="list-style-type: none"> The X Bus connector contact is faulty due to vibration or shock. Excessive noise is applied to the X Bus connector. An X Bus Unit was removed. An error occurred in an X Bus Unit. 			○			page 3-463
15110000 hex [NX502]	X Bus Unit Backup Failed	Backup of X Bus Unit settings failed.	<ul style="list-style-type: none"> The Unit configuration information registered in the CPU Unit does not match the actual configuration. 				○		page 3-463
15120000 hex [NX502]	X Bus Unit Restore Operation Failed	The restore operation for an X Bus Unit ended in an error.	<ul style="list-style-type: none"> The Unit configuration information in the backup file does not match the actual configuration. 				○		page 3-464

3-4-2 Error Descriptions

X Bus

Event name	X Bus Unit Configuration Setting Error		Event code	15100000 hex		
Meaning	The X Bus Unit configuration setting saved in non-volatile memory has been lost.					
Source	X Bus Function Module		Source details	Master	Detection timing	At power ON, at Controller reset, or when downloading X Bus Unit configuration information
Error attributes	Level	Partial fault	Recovery	Download the X Bus Unit configuration information.	Log category	System
Effects	User program	Continues.	Operation	---		
System-defined variables	Variable	Data type		Name		
	None	---		---		
Cause and correction	Assumed cause		Correction		Prevention	
	<ul style="list-style-type: none"> The power supply to the Controller was interrupted or communications with the Sysmac Studio were disconnected while downloading the X Bus Unit configuration setting or clearing memory. Non-volatile memory failure 		Download the X Bus Unit configuration setting and all the X Bus Unit settings from Sysmac Studio. If the error persists even after you make the above corrections, the nonvolatile memory is faulty. Replace the CPU Unit and download all settings from Sysmac Studio.		Do not turn OFF power during download or memory clear.	
Attached information	None					
Precautions/Remarks	None					

Event name	Number of Mountable X Bus Units Exceeded		Event code	24C00000 hex	
Meaning	The number of connected X Bus Units exceeds the specified value for the CPU Unit.				
Source	X Bus Function Module		Source details	Master	Detection timing At power ON or Controller reset
Error attributes	Level	Partial fault	Recovery	Cycle the power supply or reset the Controller.	Log category System
Effects	User program	Continues.	Operation	---	
System-defined variables	Variable	Data type		Name	
	None	---		---	
Cause and correction	Assumed cause	Correction		Prevention	
	More than the maximum number of X Bus Units are connected.	Keep the number of connected X Bus Units at the specified number or less. Download the settings for all the X Bus Units after this error is cleared.		Keep the number of Units connected to the maximum or less.	
Attached information	None				
Precautions/Remarks	None				

Event name	Unsupported X Bus Unit Mounted		Event code	24C10000 hex	
Meaning	Unsupported X Bus Unit is mounted.				
Source	X Bus Function Module		Source details	Master	Detection timing At power ON or Controller reset
Error attributes	Level	Partial fault	Recovery	Cycle the power supply or reset the Controller.	Log category System
Effects	User program	Continues.	Operation	---	
System-defined variables	Variable	Data type		Name	
	None	---		---	
Cause and correction	Assumed cause	Correction		Prevention	
	Unsupported X Bus Unit was detected.	Remove the unsupported X Bus Unit. Download the settings for all the X Bus Units after this error is cleared.		Use X Bus Units supported by the CPU Unit.	
Attached information	Attached information 1: A value from 1 to 4, which represents the unit number of Unit where abnormality is detected				
Precautions/Remarks	None				

Event name	X Bus Function Processing Error		Event code	44300000 hex	
Meaning	A fatal error was detected in the X Bus Function Module.				
Source	X Bus Function Module		Source details	Master	Detection timing Continuously
Error attributes	Level	Partial fault	Recovery	Cycle the power supply or reset the Controller.	Log category System
Effects	User program	Continues.	Operation	---	
System-defined variables	Variable	Data type		Name	
	None	---		---	
Cause and correction	Assumed cause		Correction		Prevention
	An error occurred in the software.		Contact your OMRON representative.		None
Attached information	Attached information 1: System information Attached information 2: System information Attached Information 3: System information Attached Information 4: System information				
Precautions/Remarks	None				

Event name	X Bus Unit Version Not Matched		Event code	35600000 hex		
Meaning	There is a mounted X Bus Unit with a unit version earlier than that in the Unit configuration information registered in the CPU Unit.					
Source	X Bus Function Module		Source details	Master	Detection timing	At power ON, at Controller reset, or when downloading X Bus Unit configuration information
Error attributes	Level	Minor fault	Recovery	Cycle the power supply, reset the Controller, or download the X Bus Unit configuration information.	Log category	System
Effects	User program	Continues.	Operation	---		
System-defined variables	Variable	Data type		Name		
	None	---		---		
Cause and correction	Assumed cause		Correction		Prevention	
	The unit version of an X Bus Unit mounted in the actual hardware configuration is earlier than that in the Unit configuration information registered in the CPU Unit.		To match the Unit configuration information to the actual hardware configuration, download the Unit configuration information that includes the unit version of the X Bus Unit actually mounted to the CPU Unit. To match the actual hardware configuration to the Unit configuration information, replace the X Bus Unit with a Unit of unit version that is later than or equal to that in the Unit configuration information. Download the settings for all the X Bus Units after this error is cleared.		Download the Unit configuration information to the CPU Unit after confirming that the comparison result on the Compare and Merge window is not "Not compatible".	
Attached information	Attached information 1: A value from 1 to 4, which represents the unit number of Unit where abnormality is detected Attached Information 2: Unit version of Unit configuration information					
Precautions/Remarks	None					

Event name	Unregistered X Bus Unit Mounted		Event code	35610000 hex	
Meaning	There is a mounted X Bus Unit that does not exist in the Unit configuration information registered in the CPU Unit. An event is registered for every applicable X Bus Unit.				
Source	X Bus Function Module		Source details	Master	Detection timing At power ON, at Controller reset, or when downloading X Bus Unit configuration information
Error attributes	Level	Minor fault	Recovery	Cycle the power supply, reset the Controller, or download the X Bus Unit configuration information.	Log category System
Effects	User program	Continues.	Operation	---	
System-defined variables	Variable	Data type		Name	
	None	---		---	
Cause and correction	Assumed cause		Correction		Prevention
	<ul style="list-style-type: none"> There is a mounted Unit that does not exist in the Unit configuration information registered in the CPU Unit. There is a mounted X Bus Unit in which the X Bus Unit Mounting Setting is set to <i>Disabled</i>. 		<ul style="list-style-type: none"> To match the Unit configuration information to the actual hardware configuration, download the Unit configuration information that includes the X Bus Unit added to the CPU Unit. To match the actual hardware configuration to the Unit configuration information, remove the X Bus Unit with this event. To match the Unit configuration information to the actual hardware configuration, download the Unit configuration information to the CPU Unit after setting the X Bus Unit Mounting Setting to <i>Enabled</i>. To match the actual hardware configuration to the Unit configuration information, remove the X Bus Unit with this event. <p>Download the settings for all the X Bus Units after this error is cleared.</p>		Match the project downloaded to the CPU Unit with the system configuration.
Attached information	Attached information 1: A value from 1 to 4, which represents the mounting position of the X Bus Unit				
Precautions/Remarks	None				

Event name	Registered X Bus Unit Not Mounted		Event code	35620000 hex		
Meaning	One or more X Bus Units set in the Unit configuration information registered in the CPU Unit are not mounted. An event is registered for every applicable X Bus Unit.					
Source	X Bus Function Module		Source details	Master	Detection timing	At power ON, at Controller reset, or when downloading X Bus Unit configuration information
Error attributes	Level	Minor fault	Recovery	Cycle the power supply, reset the Controller, or download the X Bus Unit configuration information.	Log category	System
Effects	User program	Continues.	Operation	---		
System-defined variables	Variable	Data type		Name		
	None	---		---		
Cause and correction	Assumed cause		Correction		Prevention	
	One or more X Bus Units set in the Unit configuration information registered in the CPU Unit are not mounted.		To match the actual hardware configuration to the Unit configuration information, mount the X Bus Unit with this event. To match the Unit configuration information to the actual hardware configuration, delete the X Bus Unit from the Unit configuration information and download it to the CPU Unit. Download the settings for all the X Bus Units after this error is cleared.		Match the project downloaded to the CPU Unit with the system configuration.	
Attached information	Attached information 1: A value from 1 to 4, which represents the unit number of Unit where abnormality is detected					
Precautions/Remarks	None					

Event name	X Bus Unit Serial Number Mismatch		Event code	35630000 hex	
Meaning	There is a mounted X Bus Unit with a serial number different from that in the Unit configuration information registered in the CPU Unit.				
Source	X Bus Function Module		Source details	Master	Detection timing At power ON, at Controller reset, or when downloading X Bus Unit configuration information
Error attributes	Level	Minor fault	Recovery	Cycle the power supply, reset the Controller, or download the X Bus Unit configuration information.	Log category System
Effects	User program	Continues.	Operation	---	
System-defined variables	Variable	Data type		Name	
	None	---		---	
Cause and correction	Assumed cause		Correction		Prevention
	One or more X Bus Units with the serial number set in the Unit configuration information registered in the CPU Unit are not mounted.		To match the actual hardware configuration to the Unit configuration information, match the serial numbers of the X Bus Units. To match the Unit configuration information to the actual hardware configuration, download the Unit configuration information to the CPU Unit after setting the serial number of the corresponding X Bus Unit. Download the settings for all the X Bus Units after this error is cleared.		To <i>enable</i> serial number matching, read the actual serial number of the installed Units into the Sysmac Studio project first.
Attached information	Attached information 1: A value from 1 to 4, which represents the unit number of Unit where abnormality is detected Attached Information 2: Serial number in the Unit configuration information				
Precautions/Remarks	None				

Event name	X Bus Unit Startup Error		Event code	85A00000 hex		
Meaning	Starting an X Bus Unit failed.					
Source	X Bus Function Module		Source details	Master	Detection timing	At power ON, at Controller reset, or when downloading X Bus Unit configuration information
Error attributes	Level	Minor fault	Recovery	Cycle the power supply, reset the Controller, or download the X Bus Unit configuration information.	Log category	System
Effects	User program	Continues.	Operation	---		
System-defined variables	Variable	Data type		Name		
	None	---		---		
Cause and correction	Assumed cause		Correction		Prevention	
	A startup error occurred in an X Bus Unit.		Cycle the power supply. If this abnormality recurs, replace the X Bus Unit.		None	
Attached information	Attached information 1: A value from 1 to 4, which represents the unit number of Unit where abnormality is detected Attached information 2: System information					
Precautions/Remarks	None					

Event name	X Bus Unit Communications Error		Event code	85A10000 hex		
Meaning	A communications error that prevents normal X Bus communications was detected. An event is registered for every applicable X Bus Unit.					
Source	X Bus Function Module		Source details	Master	Detection timing	Continuously
Error attributes	Level	Minor fault	Recovery	Cycle the power supply, reset the Controller, or download the X Bus Unit configuration information.	Log category	System
Effects	User program	Continues.	Operation	---		
System-defined variables	Variable	Data type		Name		
	None	---		---		
Cause and correction	Assumed cause		Correction		Prevention	
	The X Bus connector contact is faulty due to vibration or shock.		Securely install the X Bus Unit and fix it with the end plate.		Install the Unit according to the user's manual.	
	Excessive noise is applied to the X Bus connector.		Implement noise suppression measures in accordance with the user's manual.		Install the Unit according to the user's manual.	
	An X Bus Unit was removed.		Reinstall the removed X Bus Unit.		Install the Unit according to the user's manual.	
	An error occurred in an X Bus Unit.		Cycle the power supply. If this abnormality recurs, replace the X Bus Unit.		None	
Attached information	Attached information 1: A value from 1 to 4, which represents the unit number of Unit where abnormality is detected Attached information 2: System information					
Precautions/Remarks	None					

Event name	X Bus Unit Backup Failed		Event code	15110000 hex		
Meaning	Backup of X Bus Unit settings failed.					
Source	X Bus Function Module		Source details	Master	Detection timing	When backup is executed
Error attributes	Level	Observation	Recovery	---	Log category	System
Effects	User program	Continues.	Operation	---		
System-defined variables	Variable	Data type		Name		
	None	---		---		
Cause and correction	Assumed cause		Correction		Prevention	
	The Unit configuration information registered in the CPU Unit does not match the actual configuration.		Match the actual device configuration to the set Unit configuration information, or match the Unit configuration information to the actual device configuration, and then back up the X Bus Unit settings.		Back up the X Bus Unit settings in a state where the Unit configuration information and actual device configuration match.	
Attached information	Attached information 1: System information					
Precautions/Remarks	None					

Event name	X Bus Unit Restore Operation Failed		Event code	15120000 hex	
Meaning	The restore operation for an X Bus Unit ended in an error.				
Source	X Bus Function Module		Source details	Master	Detection timing During restoration
Error attributes	Level	Observation	Recovery	---	Log category System
Effects	User program	Continues.	Operation	---	
System-defined variables	Variable	Data type		Name	
	None	---		---	
Cause and correction	Assumed cause	Correction		Prevention	
	The Unit configuration information in the backup file does not match the actual device configuration.	Match the actual configuration with the Unit configuration information in the backup file, or perform restoration using a backup file with the same Unit configuration information as the actual device configuration.		Perform restoration in a state where the Unit configuration information in the backup file is the same as the actual device configuration.	
Attached information	Attached information 1: System information				
Precautions/Remarks	None				

3-5 Errors in the X Bus Unit Common Function Module

This section describes the errors (events) that occur in the X Bus Unit Common Function Module.

3-5-1 Error Tables

X Bus Units

Event code	Event name	Meaning	Assumed cause	Level					Reference
				M a j	P r t	M i n	O b s	I n f o	
00640000 hex	Main Memory Check Error	An error was detected in the main memory check in the X Bus Unit.	<ul style="list-style-type: none"> A conductive object has gotten inside. Noise <ul style="list-style-type: none"> Data corruption in memory Microcomputer malfunctioning Memory write circuit malfunctioning An error occurred in the software. <ul style="list-style-type: none"> Data was corrupted by cosmic rays or radiation. The X Bus Unit has failed. <ul style="list-style-type: none"> Memory element failure Failure of memory peripheral circuits 			○			page 3-469
00650000 hex	Non-volatile Memory Life Warning	The number of times to erase data in non-volatile memory has exceeded the warning value. Or, the number of bad blocks in memory exceeded the warning value.	<ul style="list-style-type: none"> Non-volatile memory life is ending. 			○	⊙		page 3-470

Event code	Event name	Meaning	Assumed cause	Level					Reference
				M a j	P r t	M i n	O b s	I n f o	
11000000 hex	X Bus Unit Settings Transfer Error	Unit settings were not transferred properly.	<ul style="list-style-type: none"> The Unit settings are invalid because the power to the Controller was cut off while the Unit settings were being downloaded. The Unit settings are incorrect because the Controller was powered OFF during Clear All Memory operation. The Unit settings are incorrect because the Controller was powered OFF during restore operation. Non-volatile memory failure 			○			page 3-470
110C0000 hex	Incorrect X Bus Unit Settings	The memory used exceeds the upper limit, or the X Bus Unit setting data is corrupted.	<ul style="list-style-type: none"> The upper limit of the data size was exceeded. The main memory capacity was exceeded. Non-volatile memory is deteriorating or has failed. 			○			page 3-471
110D0000 hex	Present Values of Retained Variables Not Saved	The process of saving the current value of the retained variable during power interruptions could not be performed because an error occurred in the software.	<ul style="list-style-type: none"> An error occurred in the software. 			○			page 3-472
110E0000 hex	Non-volatile Memory Restored or Formatted	An error was detected in the non-volatile memory check and file system recovery or formatting was executed. Previous files may have been deleted.	<ul style="list-style-type: none"> The Controller power supply was turned OFF while the BUSY indicator was lit. The power supply to the Controller was interrupted momentarily while the BUSY indicator was lit. 			○			page 3-473
110F0000 hex	Non-volatile Memory Data Corrupted	A file that must be in non-volatile memory is missing or corrupted.	<ul style="list-style-type: none"> The Controller power supply was turned OFF while the BUSY indicator was lit. The power supply to the Controller was interrupted momentarily while the BUSY indicator was lit. The X Bus Unit has failed. 			○			page 3-474

Event code	Event name	Meaning	Assumed cause	Level					Reference
				M a j	P r t	M i n	O b s	I n f o	
11100000 hex	Main Memory Check Error	An error was detected in the main memory check in the X Bus Unit.	<ul style="list-style-type: none"> A conductive object has gotten inside. Noise <ul style="list-style-type: none"> Data corruption in memory Microcomputer malfunctioning Memory write circuit malfunctioning An error occurred in the software. <ul style="list-style-type: none"> Data was corrupted by cosmic rays or radiation. The X Bus Unit has failed. <ul style="list-style-type: none"> Memory element failure Failure of memory peripheral circuits 			○			page 3-475
11120000 hex	Present Values of Retained Variables Restoration Error	The present values of retained variables could not be restored at startup and the values were initialized.	<ul style="list-style-type: none"> An error occurred in the software. Backup memory failure 			○			page 3-475
41000000 hex	X Bus Unit Common Function Processing Error	A fatal error was detected in the X Bus Unit Common Function Module.	<ul style="list-style-type: none"> An error occurred in the software. 			○			page 3-476
41010000 hex	X Bus Unit Common Function Processing Error	A fatal error was detected in the X Bus Unit Common Function Module.	<ul style="list-style-type: none"> An error occurred in the software. 			○			page 3-476
41020000 hex	X Bus Unit Common Function Processing Error	A fatal error was detected in the X Bus Unit Common Function Module.	<ul style="list-style-type: none"> An error occurred in the software. 			○			page 3-477
41050000 hex	X Bus Unit Common Function Processing Error	A fatal error was detected in the PLC Function Module.	<ul style="list-style-type: none"> An error occurred in the software. 			○			page 3-477
41060000 hex	X Bus Unit Common Function Processing Error	A fatal error was detected in the X Bus Unit Common Function Module.	<ul style="list-style-type: none"> An error occurred in the software. 			○			page 3-478
41070000 hex	X Bus Unit Common Function Processing Error	A fatal error was detected in the X Bus Unit Common Function Module.	<ul style="list-style-type: none"> An error occurred in the software. 			○			page 3-478

Event code	Event name	Meaning	Assumed cause	Level					Reference
				M a j	P r t	M i n	O b s	I n f o	
65900000 hex	I/O Refreshing Timeout Error	Consecutive I/O refresh failures occurred during the primary periodic task or periodic task period.	<ul style="list-style-type: none"> The volume of tag data link communications that refresh I/Os during task period is too high. 				○		page 3-479
11010000 hex	Event Log Save Error	Saving an event log failed.	<ul style="list-style-type: none"> Data in the event log area is not correct. 				○		page 3-479
11110000 hex	X Bus Common System Information	This is the internal information of the X Bus Unit Common Function Module.	<ul style="list-style-type: none"> This is the internal information of the X Bus Unit Common Function Module. This event is recorded as additional information for other events. 				○		page 3-480
41030000 hex	X Bus Unit System Information	This is the internal information of the X Bus Unit Common Function Module.	<ul style="list-style-type: none"> This is the internal information of the X Bus Unit Common Function Module. This event is recorded as additional information for other events. 				○		page 3-480
41040000 hex	X Bus Unit System Information	This is the internal information of the X Bus Unit Common Function Module.	<ul style="list-style-type: none"> This is the internal information of the X Bus Unit Common Function Module. This event is recorded as additional information for other events. 				○		page 3-481
91000000 hex	X Bus Unit Settings Downloaded	Unit settings were downloaded.	<ul style="list-style-type: none"> The Unit settings were downloaded. 				○		page 3-481
91020000 hex	X Bus Unit Settings All Cleared	Clear All Memory operation was performed.	<ul style="list-style-type: none"> The memory was all cleared by a user with administrator privileges. 				○		page 3-482
91030000 hex	All Errors Cleared	All errors that were occurring were cleared.	<ul style="list-style-type: none"> The user cleared all errors that were occurring 				○		page 3-482
91040000 hex	Event Log Cleared	The event log was cleared.	<ul style="list-style-type: none"> The event log was cleared by the user. 				○		page 3-483
91050000 hex	Power Turned ON	The power supply was turned ON.	<ul style="list-style-type: none"> The power supply was turned ON. 				○		page 3-483
91060000 hex	Power Interrupted	The power supply was interrupted.	<ul style="list-style-type: none"> The power supply was interrupted. 				○		page 3-484
910F0000 hex	Access Rights Forcibly Released	The access rights were forcibly released.	<ul style="list-style-type: none"> The access rights were forcibly released. 				○		page 3-484
91110000 hex	Start Instruction of Omron Maintenance	Maintenance by Omron maintenance personnel was begun.	<ul style="list-style-type: none"> Maintenance by Omron maintenance personnel was begun. 				○		page 3-485
91120000 hex	End Instruction of Omron Maintenance	Maintenance by Omron maintenance personnel was ended.	<ul style="list-style-type: none"> Maintenance by Omron maintenance personnel was ended. 				○		page 3-485

Event code	Event name	Meaning	Assumed cause	Level					Reference
				M a j	P r t	M i n	O b s	I n f o	
91130000 hex	Event Logging Stopped	Some event logs could not be saved.	<ul style="list-style-type: none"> Event saving process stopped due to power interruption of the EIP Unit. 					○	page 3-486

3-5-2 Error Descriptions

X Bus Unit

Event name	Main Memory Check Error		Event code	00640000 hex			
Meaning	An error was detected in the main memory check in the X Bus Unit.						
Source	X Bus Unit Common Function Module		Source details	1 to 4: Mounting position of the X Bus Unit	Detection timing	Continuously	
Error attributes	Level	Minor fault	Recovery	Cycle the power supply, or reset the Controller	Log category	System	
Effects	User program	---	Operation	Stops.			
System-defined variables	Variable	None	Data type	---	Name	---	
Cause and correction	Assumed cause	A conductive object has gotten inside.	Correction	If there is conductive material nearby, blow out the X Bus Unit with air.	Prevention	Do not do any metal working in the vicinity of the control panel. Keep the control panel closed.	
		Noise <ul style="list-style-type: none"> Data corruption in memory Microcomputer malfunctioning Memory write circuit malfunctioning 		If the error did not result from the above causes, cycle the power to the Controller and see if that clears the error. If the error occurs frequently, check the FG, power supply lines, and other noise entry paths, and implement noise countermeasures as required.		Implement noise countermeasures.	
		An error occurred in the software. <ul style="list-style-type: none"> Data was corrupted by cosmic rays or radiation. 					None
		The X Bus Unit has failed. <ul style="list-style-type: none"> Memory element failure Failure of memory peripheral circuits 			Non-volatile memory life is ending. Replace the X Bus Unit.		Perform regular inspection.
Attached information	Attached information 1: System information Attached information 2: System information						
Precautions/Remarks	None						

Event name	Non-volatile Memory Life Warning		Event code	00650000 hex		
Meaning	The number of times to erase data in non-volatile memory has exceeded the warning value. Or, the number of bad blocks in memory exceeded the warning value.					
Source	X Bus Unit Common Function Module		Source details	1 to 4: Mounting position of the X Bus Unit	Detection timing	At power ON, Controller reset, or periodically
Error attributes	Level	Minor fault	Recovery	---	Log category	System
Effects	User program	---	Operation	Not affected.		
System-defined variables	Variable	Data type		Name		
	None	---		---		
Cause and correction	Assumed cause		Correction		Prevention	
	Non-volatile memory life is ending.		Non-volatile memory life is ending. Replace the X Bus Unit.		None	
Attached information	None					
Precautions/Remarks	None					

Event name	X Bus Unit Settings Transfer Error		Event code	11000000 hex		
Meaning	Unit settings were not transferred properly.					
Source	X Bus Unit Common Function Module		Source details	1 to 4: Mounting position of the X Bus Unit	Detection timing	At power ON, or Controller reset
Error attributes	Level	Minor fault	Recovery	Cycle the power supply, or reset the Controller	Log category	System
Effects	User program	---	Operation	Stops.		
System-defined variables	Variable	Data type		Name		
	None	---		---		
Cause and correction	Assumed cause		Correction		Prevention	
	<ul style="list-style-type: none"> The Unit settings are invalid because the power to the Controller was cut off while the Unit settings were being downloaded. The Unit settings are incorrect because the Controller was powered OFF during Clear All Memory operation. The Unit settings are incorrect because the Controller was powered OFF during restore operation. 		After clearing all memory using Sysmac Studio, download the project. If attached information is registered, turn the Controller power OFF and ON again, and then take the above measure. If memory all clear cannot be executed from Sysmac Studio, transfer the Unit settings by restoring from the SD Memory Card.		<ul style="list-style-type: none"> Do not turn OFF the power to the Controller while the Unit settings are being downloaded. Do not turn OFF the power to the Controller during the Clear All Memory operation. Do not turn OFF the power to the Controller during restore operation. 	
	Non-volatile memory failure		If this error occurs frequently even after you make the above corrections, replace the Unit.		None	
Attached information	Attached information 1: Cause details None: Power OFF during download or restore operation Downloading/preDownloading: Error occurrence timing for causes other than the above (during transfer/preparing for transfer)					
Precautions/Remarks	None					

Event name	Incorrect X Bus Unit Settings		Event code	110C0000 hex	
Meaning	The memory used exceeds the upper limit, or the X Bus Unit setting data is corrupted.				
Source	X Bus Unit Common Function Module		Source details	None/1 to 4: Mounting position of the X Bus Unit	Detection timing When downloading, at power ON, or at Controller reset
Error attributes	Level	Minor fault	Recovery	Cycle the power supply or Controller reset	Log category System
Effects	User program	---	Operation	Stops.	
System-defined variables	Variable	Data type		Name	
	None	---		---	
Cause and correction	Assumed cause		Correction		Prevention
	The upper limit of the data size was exceeded.		If an event on restrictions on the number of items used occurred at the same time as this event, correct the user program and settings so that the number of items used does not exceed the upper limit and then download the data again.		None
	The main memory capacity was exceeded.		If an event on restrictions on the number of items used did not occur at the same time as this event, perform the Clear All Memory operation, cycle the power supply, and then confirm that this event was cleared. If it was cleared, reduce the size of the project, e.g., by sharing programs, and then download the project again.		
	Non-volatile memory is deteriorating or has failed.		If this error persists even after you implement the second correction, replace the X Bus Unit.		
Attached information	None				
Precautions/Remarks	None				

Event name	Present Values of Retained Variables Not Saved		Event code	110D0000 hex		
Meaning	The process of saving the current value of the retained variable during power interruptions could not be performed because an error occurred in the software.					
Source	X Bus Unit Common Function Module		Source details	1 to 4: Mounting position of the X Bus Unit	Detection timing	At power ON, or Controller reset
Error attributes	Level	Minor fault	Recovery	Cycle the power supply.	Log category	System
Effects	User program	---	Operation	Stops.		
System-defined variables	Variable	Data type		Name		
	None	---		---		
Cause and correction	Assumed cause		Correction		Prevention	
	An error occurred in the software.		If this error is not cleared even after the power to the Controller is cycled or the Controller is reset, replace the X Bus Unit.		None	
Attached information	None					
Precautions/Remarks	None					

Event name	Non-volatile Memory Restored or Formatted		Event code	110E0000 hex	
Meaning	An error was detected in the non-volatile memory check and file system recovery or formatting was executed. Previous files may have been deleted.				
Source	X Bus Unit Common Function Module		Source details	1 to 4: Mounting position of the X Bus Unit	Detection timing At power ON, or Controller reset
Error attributes	Level	Minor fault	Recovery	Cycle the power supply, or reset the Controller	Log category System
Effects	User program	---	Operation	Stops.	
System-defined variables	Variable		Data type		Name
	None		---		---
Cause and correction	Assumed cause		Correction		Prevention
	The Controller power supply was turned OFF while the BUSY indicator was lit.		Verify the project with Sysmac Studio, and if it matches, check whether this error is cleared by cycling the power supply, or resetting the Controller. If this error is cleared, check whether the equipment operates properly. If the project mismatches, the error is not cleared, or the device does not operate properly, perform Clear All Memory operation to the X Bus Unit where the error is occurring from Sysmac Studio, and then download the settings to the X Bus Unit again. If this error is not cleared even after the Controller power is cycled, or the Controller is reset, the memory is corrupted. Replace the X Bus Unit. If the Controller power is cycled, or the Controller is reset without re-downloading the project, the Controller may behave unintentionally and it is very dangerous.		Do not turn OFF the power while the BUSY indicator is lit.
	The power supply to the Controller was interrupted momentarily while the BUSY indicator was lit.				Take appropriate measures to ensure that the specified power with the rated voltage and frequency is supplied in places where the power supply is unstable.
Attached information	Attached information 1: Recovery performed 00000000 hex: File system recovery succeeded, 00000001 hex: Formatting executed				
Precautions/Remarks	Be sure to check that the projects match, check the operation of the equipment, or retransfer the project. If the Controller power is cycled or the Controller is reset without performing the above procedure, the Controller may behave unintentionally and it is very dangerous.				

Event name	Non-volatile Memory Data Corrupted		Event code	110F0000 hex		
Meaning	A file that must be in non-volatile memory is missing or corrupted.					
Source	X Bus Unit Common Function Module		Source details	1 to 4: Mounting position of the X Bus Unit	Detection timing	At power ON, or Controller reset
Error attributes	Level	Minor fault	Recovery	Cycle the power supply, or reset the Controller	Log category	System
Effects	User program	---	Operation	Stops.		
System-defined variables	Variable	Data type		Name		
	None	---		---		
Cause and correction	Assumed cause		Correction		Prevention	
	The Controller power supply was turned OFF while the BUSY indicator was lit.		After clearing all memory using Sysmac Studio, download the project.		Do not turn OFF the power while the BUSY indicator is lit.	
	The power supply to the Controller was interrupted momentarily while the BUSY indicator was lit.				Take appropriate measures to ensure that the specified power with the rated voltage and frequency is supplied in places where the power supply is unstable.	
	The X Bus Unit has failed.		If this error persists even after you implement the above corrections, replace the X Bus Unit.		None	
Attached information	None					
Precautions/Remarks	None					

Event name	Main Memory Check Error		Event code	11100000 hex		
Meaning	An error was detected in the main memory check in the X Bus Unit.					
Source	X Bus Unit Common Function Module		Source details	1 to 4: Mounting position of the X Bus Unit	Detection timing	Continuously
Error attributes	Level	Minor fault	Recovery	Cycle the power supply.	Log category	System
Effects	User program	---	Operation	Stops.		
System-defined variables	Variable	Data type		Name		
	None	---		---		
Cause and correction	Assumed cause		Correction		Prevention	
	A conductive object has gotten inside.		If there is conductive material nearby, blow out the X Bus Unit with air.		Do not do any metal working in the vicinity of the control panel. Keep the control panel closed.	
	Noise <ul style="list-style-type: none"> Data corruption in memory Microcomputer malfunctioning Memory write circuit malfunctioning 		If the error did not result from the above causes, cycle the power to the Controller and see if that clears the error. If the error occurs frequently, check the FG, power supply lines, and other noise entry paths, and implement noise countermeasures as required.		Implement noise countermeasures.	
	An error occurred in the software. <ul style="list-style-type: none"> Data was corrupted by cosmic rays or radiation. 				None	
The X Bus Unit has failed. <ul style="list-style-type: none"> Memory element failure Failure of memory peripheral circuits 		If this error is not cleared even after the power to the Controller is cycled or the Controller is reset, replace the X Bus Unit.		Perform regular inspection.		
Attached information	Attached information 1: System information					
Precautions/Remarks	None					

Event name	Present Values of Retained Variables Restoration Error		Event code	11120000 hex		
Meaning	The present values of retained variables could not be restored at startup and the values were initialized.					
Source	X Bus Unit Common Function Module		Source details	1 to 4: Mounting position of the X Bus Unit	Detection timing	At power ON or Controller reset
Error attributes	Level	Minor fault	Recovery	Cycle the power supply, reset the Controller	Log category	System
Effects	User program	---	Operation	Stops.		
System-defined variables	Variable	Data type		Name		
	None	---		---		
Cause and correction	Assumed cause		Correction		Prevention	
	<ul style="list-style-type: none"> An error occurred in the software. Backup memory failure 		If this error is not cleared even after the power to the Controller is cycled or the Controller is reset, replace the X Bus Unit.		None	
Attached information	None					
Precautions/Remarks	None					

3 Error Descriptions and Corrections

Event name	X Bus Unit Common Function Processing Error		Event code	41000000 hex		
Meaning	A fatal error was detected in the X Bus Unit Common Function Module.					
Source	X Bus Unit Common Function Module		Source details	1 to 4: Mounting position of the X Bus Unit	Detection timing	Continuously
Error attributes	Level	Minor fault	Recovery	Cycle the power supply.	Log category	System
Effects	User program	---	Operation	Stops.		
System-defined variables	Variable		Data type		Name	
	None		---		---	
Cause and correction	Assumed cause		Correction		Prevention	
	An error occurred in the software.		Contact your OMRON representative.		None	
Attached information	Attached information 1: System information Attached information 2: System information Attached Information 3: System information Attached Information 4: System information					
Precautions/Remarks	None					

Event name	X Bus Unit Common Function Processing Error		Event code	41010000 hex		
Meaning	A fatal error was detected in the X Bus Unit Common Function Module.					
Source	X Bus Unit Common Function Module		Source details	1 to 4: Mounting position of the X Bus Unit	Detection timing	Continuously
Error attributes	Level	Minor fault	Recovery	Cycle the power supply.	Log category	System
Effects	User program	---	Operation	Stops.		
System-defined variables	Variable		Data type		Name	
	None		---		---	
Cause and correction	Assumed cause		Correction		Prevention	
	An error occurred in the software.		Contact your OMRON representative.		None	
Attached information	Attached information 1: System information Attached information 2: System information Attached Information 3: System information Attached Information 4: System information					
Precautions/Remarks	None					

Event name	X Bus Unit Common Function Processing Error		Event code	41020000 hex		
Meaning	A fatal error was detected in the X Bus Unit Common Function Module.					
Source	X Bus Unit Common Function Module		Source details	1 to 4: Mounting position of the X Bus Unit	Detection timing	Continuously
Error attributes	Level	Minor fault	Recovery	Cycle the power supply or Controller reset	Log category	System
Effects	User program	---	Operation	Not affected.		
System-defined variables	Variable		Data type		Name	
	None		---		---	
Cause and correction	Assumed cause		Correction		Prevention	
	An error occurred in the software.		Contact your OMRON representative.		None	
Attached information	Attached information 1: System information Attached information 2: System information Attached Information 3: System information Attached Information 4: System information					
Precautions/Remarks	None					

Event name	X Bus Unit Common Function Processing Error		Event code	41050000 hex		
Meaning	A fatal error was detected in the PLC Function Module.					
Source	X Bus Unit Common Function Module		Source details	1 to 4: Mounting position of the X Bus Unit	Detection timing	Continuously
Error attributes	Level	Minor fault	Recovery	Cycle the power supply.	Log category	System
Effects	User program	---	Operation	Stops. Connection to Sysmac Studio is lost.		
System-defined variables	Variable		Data type		Name	
	None		---		---	
Cause and correction	Assumed cause		Correction		Prevention	
	An error occurred in the software.		Contact your OMRON representative.		None	
Attached information	None					
Precautions/Remarks	None					

Event name	X Bus Unit Common Function Processing Error		Event code	41060000 hex	
Meaning	A fatal error was detected in the X Bus Unit Common Function Module.				
Source	X Bus Unit Common Function Module		Source details	1 to 4: Mounting position of the X Bus Unit	Detection timing Continuously
Error attributes	Level	Minor fault	Recovery	Cycle the power supply.	Log category System
Effects	User program	---	Operation	Stops. Connection to Sysmac Studio is lost.	
System-defined variables	Variable		Data type		Name
	None		---		---
Cause and correction	Assumed cause		Correction		Prevention
	An error occurred in the software.		Contact your OMRON representative.		None
Attached information	Attached information 1: System information				
Precautions/Remarks	None				

Event name	X Bus Unit Common Function Processing Error		Event code	41070000 hex	
Meaning	A fatal error was detected in the X Bus Unit Common Function Module.				
Source	X Bus Unit Common Function Module		Source details	1 to 4: Mounting position of the X Bus Unit	Detection timing Continuously
Error attributes	Level	Minor fault	Recovery	Cycle the power supply.	Log category System
Effects	User program	---	Operation	Stops.	
System-defined variables	Variable		Data type		Name
	None		---		---
Cause and correction	Assumed cause		Correction		Prevention
	An error occurred in the software.		Contact your OMRON representative.		None
Attached information	Attached information 1: System information				
Precautions/Remarks	None				

Event name	I/O Refreshing Timeout Error		Event code	65900000 hex		
Meaning	Consecutive I/O refresh failures occurred during the primary periodic task or periodic task period.					
Source	X Bus Unit Common Function Module		Source details	1 to 4: Mounting position of the X Bus Unit	Detection timing	Continuously
Error attributes	Level	Minor fault	Recovery	Cycle the power supply or Controller reset	Log category	System
Effects	User program	Continues.	Operation	Not affected.		
System-defined variables	Variable	Data type		Name		
	None	---		---		
Cause and correction	Assumed cause		Correction		Prevention	
	The volume of tag data link communications that refresh I/Os during task period is too high.		Divide I/O refresh processing in the task, for example, by moving a part of the processing to another task by setting the exclusive control of variables in tasks.		Understand the proposed corrections in advance and use tasks in the system design.	
Attached information	Attached information 1: Name of the task where the error occurred. One of the following. Primary Task: Primary periodic task Periodic Task0: Periodic task					
Precautions/Remarks	None					

Event name	Event Log Save Error		Event code	11010000 hex		
Meaning	Saving an event log failed.					
Source	X Bus Unit Common Function Module		Source details	1 to 4: Mounting position of the X Bus Unit	Detection timing	At power ON
Error attributes	Level	Observation	Recovery	---	Log category	System
Effects	User program	---	Operation	Not affected. However, some or all of the past event logs cannot be read.		
System-defined variables	Variable	Data type		Name		
	None	---		---		
Cause and correction	Assumed cause		Correction		Prevention	
	Data in the event log area is not correct.		If this error reoccurs even after cycling the power supply to the Controller, there may be a hardware failure in the event log area. Replace the X Bus Unit to use the event log function of the X Bus Unit.		None	
Attached information	Attached information 1: Error Details <ul style="list-style-type: none"> • 0: Failed to save logs for all categories • 1: Failed to save system logs • 2: Failed to save access logs • 100: Failed to save user logs 					
Precautions/Remarks	None					

3 Error Descriptions and Corrections

Event name	X Bus Unit System Information		Event code	11110000 hex		
Meaning	This is the internal information of the X Bus Unit Common Function Module.					
Source	X Bus Unit Common Function Module		Source details	1 to 4: Mounting position of the X Bus Unit	Detection timing	Continuously
Error attributes	Level	Observation	Recovery	Cycle the power supply, reset the Controller	Log category	System
Effects	User program	---	Operation	Not affected.		
System-defined variables	Variable		Data type		Name	
	None		---		---	
Cause and correction	Assumed cause		Correction		Prevention	
	This is the internal information of the X Bus Unit Common Function Module. This event is recorded as additional information for other events.		---		---	
Attached information	None					
Precautions/Remarks	None					

Event name	X Bus Unit System Information		Event code	41030000 hex		
Meaning	This is the internal information of the X Bus Unit Common Function Module.					
Source	X Bus Unit Common Function Module		Source details	1 to 4: Mounting position of the X Bus Unit	Detection timing	Continuously
Error attributes	Level	Observation	Recovery	Cycle the power supply, or reset the Controller	Log category	System
Effects	User program	---	Operation	Not affected.		
System-defined variables	Variable		Data type		Name	
	None		---		---	
Cause and correction	Assumed cause		Correction		Prevention	
	This is the internal information of the X Bus Unit Common Function Module. This event is recorded as additional information for other events.		---		---	
Attached information	Attached information 1: System information Attached information 2: System information Attached Information 3: System information Attached Information 4: System information					
Precautions/Remarks	None					

Event name	X Bus Unit System Information			Event code	41040000 hex	
Meaning	This is the internal information of the X Bus Unit Common Function Module.					
Source	X Bus Unit Common Function Module		Source details	1 to 4: Mounting position of the X Bus Unit	Detection timing	Continuously
Error attributes	Level	Information	Recovery	---	Log category	System
Effects	User program	---	Operation	Not affected.		
System-defined variables	Variable	Data type		Name		
	None	---		---		
Cause and correction	Assumed cause		Correction		Prevention	
	This is the internal information of the X Bus Unit Common Function Module. This event is recorded as additional information for other events.		---		---	
Attached information	Attached information 1: System information Attached information 2: System information Attached information 3: System information Attached information 4: System information					
Precautions/Remarks	None					

Event name	X Bus Unit Settings Downloaded			Event code	91000000 hex	
Meaning	Unit settings were downloaded.					
Source	X Bus Unit Common Function Module		Source details	1 to 4: Mounting position of the X Bus Unit	Detection timing	When Unit settings are downloaded
Error attributes	Level	Information	Recovery	---	Log category	Access
Effects	User program	---	Operation	The Unit starts to operate according to the downloaded Unit settings.		
System-defined variables	Variable	Data type		Name		
	None	---		---		
Cause and correction	Assumed cause		Correction		Prevention	
	The Unit settings were downloaded.		---		---	
Attached information	Attached information 1: Connection method <ul style="list-style-type: none"> • 1: Reserve • 2: Direct connection via Ethernet • 3: Ethernet connection via a hub Attached information 2: When attached information 1 is 2 or 3, the connection source IP address is given. When connection is made through proxy, proxy IP address is given. Attached information 3: Download type <ul style="list-style-type: none"> • 1: Download holding the outputs • 2: Download not holding outputs Attached information 4: User name registered in the CPU Unit (When the user authentication function is disabled, NULL is given).					
Precautions/Remarks	None					

3 Error Descriptions and Corrections

Event name	X Bus Unit Settings All Cleared			Event code	91020000 hex
Meaning	Clear All Memory operation was performed.				
Source	X Bus Unit Common Function Module		Source details	1 to 4: Mounting position of the X Bus Unit	Detection timing Commands from user
Error attributes	Level	Information	Recovery	---	Log category Access
Effects	User program	---	Operation	The Unit returns to factory defaults.	
System-defined variables	Variable		Data type		Name
	None		---		---
Cause and correction	Assumed cause		Correction		Prevention
	The memory was all cleared by a user with administrator privileges.		---		---
Attached information	<p>Attached information 1: Connection method</p> <ul style="list-style-type: none"> • 1: Reserve • 2: Direct connection via Ethernet • 3: Ethernet connection via a hub <p>Attached information 2: When attached information 1 is 2 or 3, the connection source IP address is given. When connection is made through proxy, proxy IP address is given.</p> <p>Attached information 4: User name registered in the CPU Unit (When the user authentication function is disabled, NULL is given).</p>				
Precautions/Remarks	None				

Event name	All Errors Cleared			Event code	91030000 hex
Meaning	All errors that were occurring were cleared.				
Source	X Bus Unit Common Function Module		Source details	1 to 4: Mounting position of the X Bus Unit	Detection timing Commands from user
Error attributes	Level	Information	Recovery	---	Log category Access
Effects	User program	---	Operation	Errors whose causes have been resolved are cleared.	
System-defined variables	Variable		Data type		Name
	None		---		---
Cause and correction	Assumed cause		Correction		Prevention
	The user cleared all errors that were occurring		---		---
Attached information	None				
Precautions/Remarks	None				

Event name	Event Log Cleared		Event code	91040000 hex	
Meaning	The event log was cleared.				
Source	X Bus Unit Common Function Module		Source details	1 to 4: Mounting position of the X Bus Unit	Detection timing Commands from user
Error attributes	Level	Information	Recovery	---	Log category Access
Effects	User program	---	Operation	Not affected.	
System-defined variables	Variable	Data type		Name	
	None	---		---	
Cause and correction	Assumed cause		Correction		Prevention
	The event log was cleared by the user.		---		---
Attached information	<p>Attached information 1: Connection method</p> <ul style="list-style-type: none"> • 1: Reserve • 2: Direct connection via Ethernet • 3: Ethernet connection via a hub <p>Attached information 2: When attached information 1 is 2 or 3, the connection source IP address is given. When connection is made through proxy, proxy IP address is given.</p> <p>Attached information 3: Cleared events</p> <ul style="list-style-type: none"> • 0: Logs for all categories were cleared. • 1: The system event log was cleared. • 2: The access event log was cleared. • 100: The user-defined event log was cleared. <p>Attached information 4: User name registered in the CPU Unit (When the user authentication function is disabled, NULL is given).</p>				
Precautions/Remarks	None				

Event name	Power Turned ON		Event code	91050000 hex	
Meaning	The power supply was turned ON.				
Source	X Bus Unit Common Function Module		Source details	1 to 4: Mounting position of the X Bus Unit	Detection timing At power ON
Error attributes	Level	Information	Recovery	---	Log category System
Effects	User program	---	Operation	Operation starts.	
System-defined variables	Variable	Data type		Name	
	None	---		---	
Cause and correction	Assumed cause		Correction		Prevention
	The power supply was turned ON.		---		---
Attached information	None				
Precautions/Remarks	None				

3 Error Descriptions and Corrections

Event name	Power Interrupted		Event code	91060000 hex		
Meaning	The power supply was interrupted.					
Source	X Bus Unit Common Function Module		Source details	1 to 4: Mounting position of the X Bus Unit	Detection timing	At power interruption
Error attributes	Level	Information	Recovery	---	Log category	System
Effects	User program	---	Operation	All operations stop.		
System-defined variables	Variable		Data type		Name	
	None		---		---	
Cause and correction	Assumed cause		Correction		Prevention	
	The power supply was interrupted.		---		---	
Attached information	None					
Precautions/Remarks	None					

Event name	Access Rights Forcibly Released		Event code	910F0000 hex		
Meaning	The access rights were forcibly released.					
Source	X Bus Unit Common Function Module		Source details	1 to 4: Mounting position of the X Bus Unit	Detection timing	Commands from user
Error attributes	Level	Information	Recovery	None	Log category	Access
Effects	User program	---	Operation	Not affected.		
System-defined variables	Variable		Data type		Name	
	None		---		---	
Cause and correction	Assumed cause		Correction		Prevention	
	The access rights were forcibly released.		---		---	
Attached information	<p>Attached information 1</p> <ul style="list-style-type: none"> • 1: Direct connection via USB • 2: Direct connection via Ethernet • 3: Remote connection via USB or Ethernet connection via a hub <p>Attached information 2: When attached information 1 is 2 or 3, the connection source IP address is given. When connection is made through proxy, proxy IP address is given.</p> <p>Attached information 4: User name registered in the CPU Unit (When the user authentication function is disabled, NULL is given).</p>					
Precautions/Remarks	None					

Event name	Start Instruction of Omron Maintenance		Event code	91110000 hex	
Meaning	Maintenance by Omron maintenance personnel was begun.				
Source	X Bus Unit Common Function Module	Source details	1 to 4: Mounting position of the X Bus Unit	Detection timing	When instructed by Omron maintenance personnel
Error attributes	Level	Information	Recovery	None	Log category Access
Effects	User program	---	Operation	Not affected.	
System-defined variables	Variable	Data type		Name	
	None	---		---	
Cause and correction	Assumed cause	Correction		Prevention	
	Maintenance by Omron maintenance personnel was begun.	---		---	
Attached information	Attached information 1: Name of the maintenance personnel Attached information 4: User name registered in the CPU Unit (When the user authentication function is disabled, NULL is given).				
Precautions/Remarks	None				

Event name	End Instruction of Omron Maintenance		Event code	91120000 hex	
Meaning	Maintenance by Omron maintenance personnel was ended.				
Source	X Bus Unit Common Function Module	Source details	1 to 4: Mounting position of the X Bus Unit	Detection timing	When instructed by Omron maintenance personnel
Error attributes	Level	Information	Recovery	None	Log category Access
Effects	User program	---	Operation	Not affected.	
System-defined variables	Variable	Data type		Name	
	None	---		---	
Cause and correction	Assumed cause	Correction		Prevention	
	Maintenance by Omron maintenance personnel was ended.	---		---	
Attached information	Attached information 1: Name of the maintenance personnel Attached information 4: User name registered in the CPU Unit (When the user authentication function is disabled, NULL is given).				
Precautions/Remarks	None				

Event name	Event Logging Stopped		Event code	91130000 hex		
Meaning	Some event logs could not be saved.					
Source	X Bus Unit Common Function Module		Source details	1 to 4: Mounting position of the X Bus Unit	Detection timing	At power ON
Error attributes	Level	Information	Recovery	---	Log category	System
Effects	User program	---	Operation	Not affected.		
System-defined variables	Variable	Data type		Name		
	None	---		---		
Cause and correction	Assumed cause		Correction		Prevention	
	Event saving process stopped due to power interruption of the EIP Unit.		---		---	
Attached information	<p>Attached information 1: Category of the log that could not be saved</p> <ul style="list-style-type: none"> • 1: System log • 2: Access log <p>Attached information 2: Presence of access logs for important operations*¹ that could not be saved</p> <ul style="list-style-type: none"> • 1: Yes • 2: None • 3: Unknown 					
Precautions/Remarks	None					

*1. Important operations are the following online operations:

- Online operation to the Controller
- Operations that can be performed only by the Administrator, Designer, and Maintainer to modify user program/Controller settings/Controller status

3-6 Errors in the Motion Control Function Module

The section provides tables of the errors (events) that can occur in the Motion Control Function Module.

They are divided into the following functional classifications.

- General motion control
- Motion control instructions

Motion control instruction errors occur when a motion control instruction is executed. Notification of these errors is provided as events, but also the upper four digits of the event code is output to the *ErrorID* output variable of the motion control instruction and to the **.Lvl.Code* system-defined variable for motion control. When you troubleshoot from the event code, make suitable corrections that are described in the corresponding event code.

3-6-1 Error Tables

General Motion Control

Event code	Event name	Meaning	Assumed cause	Level					Reference
				M a j	P r t	M i n	O b s	I n f o	
44210000 hex	Motion Control Function Processing Error	A fatal error was detected in the Motion Control Function Module.	<ul style="list-style-type: none"> • An error occurred in the software. 	○					page 3-527
14600000 hex	Absolute Encoder Home Offset Read Error	The absolute encoder current position that is retained during power interruptions was lost.	<ul style="list-style-type: none"> • When the retained variables are backed up with a battery, this event indicates that the life of the battery in the CPU Unit has expired. • An error occurred in the software. • Backup memory failure 		○				page 3-528
14610000 hex	Motion Control Parameter Setting Error	The MC parameters that were saved in non-volatile memory are missing. Or, an unsupported EtherCAT slave is assigned to the axis.	<ul style="list-style-type: none"> • The power supply to the Controller was interrupted or communications with the Sysmac Studio were disconnected while downloading the motion control parameter settings or clearing memory. • An unsupported EtherCAT slave is assigned to the axis. • Non-volatile memory failure 		○				page 3-529
14620000 hex	Cam Data Read Error	The cam data that was saved in non-volatile memory is missing.	<ul style="list-style-type: none"> • Power was interrupted during save processing for cam data • Non-volatile memory failure 		○				page 3-530

Event code	Event name	Meaning	Assumed cause	Level					Reference
				M a j	P r t	M i n	O b s	I n f o	
34600000 hex	Required Process Data Object Not Set	The object that is required for the axis type is not allocated to PDO.	<ul style="list-style-type: none"> The required PDOs are not mapped when the axis type is set to a servo axis or encoder axis. Non-volatile memory failure 		○				page 3-531
34630000 hex	Axis Slave Disabled	The slave to which the axis is assigned is disabled.	<ul style="list-style-type: none"> The slave to which the axis is assigned is disabled. 		○				page 3-532
34640000 hex	Network Configuration Information Missing for Axis Slave	The network configuration information is not registered for the slave to which the axis is assigned.	<ul style="list-style-type: none"> The EtherCAT network configuration information is not registered for the slave to which the axis is assigned. 		○				page 3-532
44200000 hex	Motion Control Initialization Error	A fatal error occurred in the system and prevented initialization of the Motion Control Function Module.	<ul style="list-style-type: none"> Hardware has failed. 		○				page 3-533
74200000 hex	Motion Control Period Exceeded	Processing for the primary periodic task was not finished within two control periods.	<ul style="list-style-type: none"> The processing load in the primary periodic task is too heavy. 		○				page 3-533
14630000 hex	Cam Table Save Error	Saving a cam table to a file failed.	<ul style="list-style-type: none"> Saving a cam table to a file failed. 			○			page 3-534
54770000 hex	Cam Table Data Error during Cam Motion	The phases are not in ascending order in the cam table.	<ul style="list-style-type: none"> Data containing cam table phases that are not in ascending order was detected during cam motion. The phase and displacement of the start point in the cam table were not 0 during cam operation. The phase of the end point in the cam table when it is converted to pulses was not 1 pulse or greater during cam operation. 			○			page 3-534
54850000 hex	Immediate Stop Instruction Executed	An Immediate Stop (MC_ImmediateStop) instruction was executed.	<ul style="list-style-type: none"> An Immediate Stop instruction was executed. 			○			page 3-535
54860000 hex	Axes Group Immediate Stop Instruction Executed	An Axes Group Immediate Stop (MC_GroupImmediateStop) instruction was executed.	<ul style="list-style-type: none"> A Group Immediate Stop instruction was executed. 			○			page 3-535

Event code	Event name	Meaning	Assumed cause	Level					Reference
				M a j	P r t	M i n	O b s	I n f o	
64450000 hex	Positive Software Limit Exceeded	The position exceeded the positive software limit while the axis is in motion.	<ul style="list-style-type: none"> The position exceeded the positive software limit. 			○			page 3-536
64460000 hex	Negative Software Limit Exceeded	The position exceeded the negative software limit while the axis is in motion.	<ul style="list-style-type: none"> The position exceeded the negative software limit. 			○			page 3-536
64470000 hex	In-position Check Time Exceeded	The in-position check was not completed within the monitoring time.	<ul style="list-style-type: none"> Time is required to complete positioning. 			○			page 3-537
64480000 hex	Following Error Limit Exceeded	The error between the command current position and actual current value exceeded the Following Error Over Value.	<ul style="list-style-type: none"> The positioning operation has poor following performance and the actual motion is slower than the command. 			○			page 3-537
64490000 hex	Immediate Stop Input	The immediate stop input turned ON.	<ul style="list-style-type: none"> An immediate stop input signal was detected. The immediate stop input signal is not connected correctly or the logic setting for the immediate stop input is wrong. 			○			page 3-538
644A0000 hex	Positive Limit Input Detected	The positive limit input turned ON.	<ul style="list-style-type: none"> A positive limit input signal was detected. The positive limit input signal is not connected correctly or the logic setting for the positive limit input is wrong. 			○			page 3-539
644B0000 hex	Negative Limit Input Detected	The negative limit input turned ON.	<ul style="list-style-type: none"> A negative limit input signal was detected. The negative limit input signal is not connected correctly or the logic setting for the negative limit input is wrong. 			○			page 3-540
64560000 hex	Illegal Following Error	The difference between the command position and the actual current position exceeds the range of 30-bit data when converted to pulses.	<ul style="list-style-type: none"> The command current position was restricted so that the axis velocity would not exceed the axis maximum velocity for the specified travel distance. Performance of positioning operation is poor and the actual motion is slower than the command. 			○			page 3-541
64570000 hex	Servo OFF Error	The Servo was turned OFF for an axis due to an axes group error.	<ul style="list-style-type: none"> The Servo was turned OFF for an axis due to an axes group error. 			○			page 3-541

Event code	Event name	Meaning	Assumed cause	Level					Reference
				M a j	P r t	M i n	O b s	I n f o	
64580000 hex	Absolute Encoder Current Position Calculation Failed	It was not possible to correctly restore the current position from the absolute encoder information that was saved when power was interrupted.	<ul style="list-style-type: none"> The unit conversion settings, the ring counter setting in the Controller, or the ring counter setting in the Servo Drive settings was changed. The position to restore when converted to pulses exceeded the range of signed 40-bit data. 			○			page 3-542
64590000 hex	Home Undefined during Coordinated Motion	Home of the logical axis became undefined during axes group motion or while decelerating to a stop.	<ul style="list-style-type: none"> The command position or actual position overflowed or underflowed for a logical axis in an axes group motion or a logical axis that was decelerating to a stop and the home definition was lost. A slave communications error occurred for a logical axis and home became undefined during axes group motion or while decelerating to a stop. A slave for a logical axis left the network or was disabled and home became undefined during axes group motion or while decelerating to a stop. 			○			page 3-543
74210000 hex	Servo Main Circuit Power OFF	The main circuit power of the Servo Drive turned OFF while the Servo was ON.	<ul style="list-style-type: none"> The main circuit power of the Servo Drive was interrupted while the Servo was ON. 			○			page 3-543
74230000 hex	Interrupt Feeding Interrupt Signal Missing	An interrupt input was not received during execution of an MC_MoveFeed (Interrupt Feeding) instruction.	<ul style="list-style-type: none"> The latch enabled range specification is invalid. There is a problem with the wiring of the interrupt signal. The sensor that outputs the interrupt signal has failed. 			○			page 3-544
74240000 hex	Homing Opposite Direction Limit Input Detected	The limit signal in the direction opposite to the homing direction was detected during a homing operation.	<ul style="list-style-type: none"> The Operation Selection at Negative Limit Input or Operation Selection at Positive Limit Input parameter is set to No reverse turn. The location of the homing input signal sensors, homing settings, and homing start position cause a limit input to be reached. The input signal sensor wiring is incorrect or the sensor is faulty. 			○			page 3-544

Event code	Event name	Meaning	Assumed cause	Level					Reference
				M a j	P r t	M i n	O b s	I n f o	
74250000 hex	Homing Direction Limit Input Detected	The limit signal in the homing direction was detected during a homing operation.	<ul style="list-style-type: none"> The Operation Selection at Negative Limit Input or Operation Selection at Positive Limit Input parameter is set to No reverse turn. The location of the homing input signal sensors, homing settings, and homing start position cause a limit input to be reached. The input signal sensor wiring is incorrect or the sensor is faulty. 			○			page 3-545
74260000 hex	Homing Limit Inputs Detected in Both Directions	The limit signals in both directions were detected during a homing operation.	<ul style="list-style-type: none"> The wiring of the limit signal is incorrect. The limit sensor is installed in the wrong location. The contact logic of the limit signal is not correct. The limit sensor failed. 			○			page 3-545
74270000 hex	Home Proximity/Homing Opposite Direction Limit Input Detected	The home proximity input and the limit signal in the direction opposite to the homing direction were detected during a homing operation.	<ul style="list-style-type: none"> The wiring of the home proximity signal or limit signal is incorrect. The home proximity sensor or limit sensor is installed in the wrong location. The contact logic of the home proximity signal or limit signal is not correct. The home proximity sensor or limit sensor failed. 			○			page 3-546
74280000 hex	Home Proximity/Homing Direction Limit Input Detected	The home proximity input and the limit signal in the homing direction were detected at the same time during a homing operation.	<ul style="list-style-type: none"> The wiring of the home proximity signal or limit signal is incorrect. The home proximity sensor or limit sensor is installed in the wrong location. The contact logic of the home proximity signal or limit signal is not correct. The home proximity sensor or limit sensor failed. 			○			page 3-547

Event code	Event name	Meaning	Assumed cause	Level					Reference
				M a j	P r t	M i n	O b s	I n f o	
74290000 hex	Home Input/ Homing Opposite Direction Limit Input Detected	The home input and the limit signal in the direction opposite to the homing direction were detected at the same time during a homing operation.	<ul style="list-style-type: none"> The wiring of the home input signal or limit signal is incorrect. The home input sensor or limit sensor is installed in the wrong location. The contact logic of the home input signal or limit signal is not correct. The home input signal output device or limit sensor failed. 			○			page 3-548
742A0000 hex	Home Input/ Homing Direction Limit Input Detected	The home input and the limit signal in the homing direction were detected at the same time during a homing operation.	<ul style="list-style-type: none"> The wiring of the home input signal or limit signal is incorrect. The home input sensor or limit sensor is installed in the wrong location. The contact logic of the home input signal or limit signal is not correct. The home input signal output device or limit sensor failed. 			○			page 3-549
742B0000 hex	Invalid Home Input Mask Distance	The setting of the home input mask distance is not suitable for the MC_Home or MC_HomeWithParameter instruction.	<ul style="list-style-type: none"> The set value of the home input mask distance when the operating mode of the MC_Home instruction is set to Proximity Reverse Turn/Home Input Mask Distance is insufficient to decelerate from the homing velocity to the homing approach velocity. 			○			page 3-549
742C0000 hex	No Home Input	There was no home signal input during the homing operation. Or, a limit signal was detected before there was a home input.	<ul style="list-style-type: none"> There was no home signal input during the homing operation. A limit signal was detected before there was a home input. 			○			page 3-550
742D0000 hex	No Home Proximity Input	There was no home proximity signal input during the homing operation.	<ul style="list-style-type: none"> There was no home proximity signal input during the homing operation when a home proximity input signal was specified. 			○			page 3-550
742F 0000 hex	Slave Error Detected	An error was detected for the EtherCAT slave or NX Unit that is allocated to an axis.	<ul style="list-style-type: none"> An error was detected for the EtherCAT slave or NX Unit that is allocated to an axis. 			○			page 3-551
74300000 hex	Axes Group Composition Axis Error	An error occurred for an axis in an axes group.	<ul style="list-style-type: none"> An error occurred for an axis in an axes group that was in motion. 			○			page 3-551

Event code	Event name	Meaning	Assumed cause	Level					Reference
				M a j	P r t	M i n	O b s	I n f o	
74330000 hex	MC Common Error Occurrence	An MC common error occurred.	<ul style="list-style-type: none"> Partial fault level MC common error occurred. 			○			page 3-552
74340000 hex	Latch Position Overflow	An overflow occurred for the latched position for the MC_TouchProbe (Enable External Latch) instruction.	<ul style="list-style-type: none"> An overflow occurred for the latched position for the MC_TouchProbe (Enable External Latch) instruction. 			○			page 3-552
74350000 hex	Latch Position Underflow	An underflow occurred for the latched position for the MC_TouchProbe (Enable External Latch) instruction.	<ul style="list-style-type: none"> An underflow occurred for the latched position for the MC_TouchProbe (Enable External Latch) instruction. 			○			page 3-553
74360000 hex	Master Sync Direction Error	The master axis continued to move in the direction opposite to the sync direction.	<ul style="list-style-type: none"> The master axis continued to move in the direction opposite to the sync direction of the master and slave axes, resulting in an overflow. 			○			page 3-553
74370000 hex	Slave Disconnection during Servo ON	One of the following occurred while the Servo was ON for the EtherCAT slave or NX Unit that is allocated to an axis. <ul style="list-style-type: none"> Disconnection or replacement Disablement Restart of the NX bus on the NXseries CPU Unit 	<ul style="list-style-type: none"> One of the following occurred while the Servo was ON for the EtherCAT slave or NX Unit that is allocated to an axis. <ul style="list-style-type: none"> Disconnection or replacement Disablement Restart of the NX bus on the NX-series CPU Unit 			○			page 3-554
74380000 hex	Feed Distance Overflow	The target position after the interrupt input was received for the MC_MoveFeed (Interrupt Feeding) instruction overflowed or underflowed.	<ul style="list-style-type: none"> The target position after the interrupt input was received for the MC_MoveFeed (Interrupt Feeding) instruction exceeded the range of signed 40-bit data when it is converted to pulses. 			○			page 3-554

Event code	Event name	Meaning	Assumed cause	Level					Reference
				M a j	P r t	M i n	O b s	I n f o	
74390000 hex	Error in Changing Servo Drive Control Mode	Changing the Control Mode was not completed within the specified time.	<ul style="list-style-type: none"> When the MC_SyncMoveVelocity instruction was stopped, the actual current velocity was not reduced to 10% or less of the maximum velocity within 10 seconds for three consecutive periods after a command velocity of 0 was output. For an OMRON 1S-series Servo Drive or G5-series Servo Drive, the actual current velocity was not reduced to 10% or less of the maximum velocity within 10 seconds for three consecutive periods when the MC_TorqueControl instruction was stopped. Changing the Control Mode of the Servo Drive between CSP, CSV, and CST was not completed within one second after the command was executed. 			○			page 3-555
743A0000 hex	Master Axis Position Read Error	The synchronized control instruction was not executed because an error occurred in the position of the master axis of the synchronized control instruction.	<ul style="list-style-type: none"> EtherCAT process data communications are not established for the master axis of the synchronized control instruction or the I/O data of the NX Unit cannot be used for control. The slave of the master axis for the synchronized control instruction was disconnected or disabled. An Absolute Encoder Current Position Calculation Failed error (64580000 hex) was detected for the master axis of the synchronized control instruction. The master axis for the synchronized control instruction is an unused axis. 			○			page 3-556

Event code	Event name	Meaning	Assumed cause	Level					Reference
				M a j	P r t	M i n	O b s	I n f o	
743B0000 hex	Auxiliary Axis Position Read Error	The synchronized control instruction was not executed because an error occurred in the position of the auxiliary axis of the synchronized control instruction.	<ul style="list-style-type: none"> EtherCAT process data communications are not established for the auxiliary axis of the synchronized control instruction or the I/O data of the NX Unit cannot be used for control. The slave of the auxiliary axis for the synchronized control instruction was disconnected or disabled. An Absolute Encoder Current Position Calculation Failed error (64580000 hex) was detected for the auxiliary axis of the synchronized control instruction. The auxiliary axis for the synchronized control instruction is an unused axis. 			○			page 3-557
84400000 hex	EtherCAT Slave Communications Error	A communications error occurred for the EtherCAT slave or NX Unit that is allocated to an axis.	<ul style="list-style-type: none"> A communications error occurred for the EtherCAT slave or NX Unit that is allocated to an axis. 			○			page 3-558
571D0000 hex (Ver. 1.02 to Ver. 1.09)	Too Many Reset Motion Control Error Instructions	There are more than 100 instances of the ResetMCErr (Reset Motion Control Error) instruction.	<ul style="list-style-type: none"> There are more than 100 instances of the ResetMCErr (Reset Motion Control Error) instruction declared in the user program. Instances inside function blocks are included. 				○		page 3-558
644C0000 hex	Following Error Warning	The following error exceeded the Following Error Warning Value.	<ul style="list-style-type: none"> Performance of positioning operation is poor and the actual motion is slower than the command. 				○		page 3-559
644D0000 hex	Velocity Warning	The command velocity exceeded the velocity warning value.	<ul style="list-style-type: none"> The command velocity exceeded the velocity warning value. 			⊙	○		page 3-559
644E0000 hex	Acceleration Warning	The command acceleration exceeded the acceleration warning value.	<ul style="list-style-type: none"> The command acceleration rate exceeded the acceleration warning value. 			⊙	○		page 3-560
644F0000 hex	Deceleration Warning	The command deceleration exceeded the deceleration warning value.	<ul style="list-style-type: none"> The command deceleration rate exceeded the deceleration warning value. 			⊙	○		page 3-560
64500000 hex	Positive Torque Warning	The torque command value exceeded the positive torque warning value.	<ul style="list-style-type: none"> The torque command value exceeded the positive torque warning value. 			⊙	○		page 3-561

Event code	Event name	Meaning	Assumed cause	Level					Reference
				M a j	P r t	M i n	O b s	I n f o	
64510000 hex	Negative Torque Warning	The torque command value exceeded the negative torque warning value.	<ul style="list-style-type: none"> The torque command value exceeded the negative torque warning value. 			○	○		page 3-561
64520000 hex	Command Position Overflow	The number of pulses for the command position overflowed.	<ul style="list-style-type: none"> In Linear Mode, the command position when converted to pulses exceeded the upper limit of signed 40-bit data. 			○	○		page 3-562
64530000 hex	Command Position Underflow	The number of pulses for the command position exceeded the valid range. (It underflowed.)	<ul style="list-style-type: none"> In Linear Mode, the command position when converted to pulses exceeded the lower limit of signed 40-bit data. 			○	○		page 3-562
64540000 hex	Actual Position Overflow	The number of pulses for the actual position overflowed.	<ul style="list-style-type: none"> The actual position when converted to pulses exceeded the upper limit of signed 40-bit data. 			○	○		page 3-563
64550000 hex	Actual Position Underflow	The number of pulses for the actual position underflowed.	<ul style="list-style-type: none"> The actual position when converted to pulses exceeded the lower limit of signed 40-bit data. 			○	○		page 3-563
74320000 hex	Slave Observation Detected	A warning was detected for an EtherCAT slave or NX Unit.	<ul style="list-style-type: none"> A warning was detected for the EtherCAT slave or NX Unit that is allocated to an axis. 			○	○		page 3-564
743C0000 hex	Cannot Execute Save Cam Table Instruction	You cannot save a cam table to a file when non-volatile memory is being accessed by another operation.	<ul style="list-style-type: none"> An attempt was made to execute the MC_SaveCamTable instruction when another operation was accessing the non-volatile memory (e.g., transfer or data trace operation from the Sysmac Studio). 				○		page 3-564
94200000 hex	Notice of Insufficient Travel Distance to Achieve Blending Transit Velocity	There is not sufficient travel distance to accelerate or decelerate to the transit velocity during blending operation.	<ul style="list-style-type: none"> When the Acceleration/Deceleration Over parameter was set to Use rapid acceleration/deceleration (Blending is changed to Buffered), the results of profile creation caused the acceleration/deceleration rate to be exceeded when blending was specified, so buffered was used. Blending was specified, but the target position was already reached, so it was changed to Buffered because the profile could not be created. 			○	○		page 3-565
94210000 hex	Error Clear from MC Test Run Tab Page	An error was cleared from the MC Test Run Pane of the Sysmac Studio.	<ul style="list-style-type: none"> An error was cleared from the MC Test Run Pane of the Sysmac Studio. 				○		page 3-565

Event code	Event name	Meaning	Assumed cause	Level					Reference
				M a j	P r t	M i n	O b s	I n f o	
94220000 hex	Slave Error Code Report	The error code was reported by the slave when a Slave Error Detected error occurred.	<ul style="list-style-type: none"> The error code was reported by the slave when a Slave Error Detected error (742F0000 hex) occurred. 					○	page 3-566

Motion Control Instructions

This section provides a table of errors (events) that occur for motion control instructions. The upper four digits of the event code give the error code (ErrorID) for the motion control instruction. For descriptions of an error code, refer to the description of the corresponding event code. For example, if the error code for the motion control instruction is 16#3461, refer to the description for event code 34610000 hex.

Event code	Event name	Meaning	Assumed cause	Level					Reference
				M a j	P r t	M i n	O b s	I n f o	
34610000 hex	Process Data Object Setting Missing	The PDO mapping is not correct.	<ul style="list-style-type: none"> The PDOs that are required for the motion control instruction are not mapped. The relevant instruction was executed for a device that does not have an object that supports the instruction. A motion control instruction that specifies phase Z (<i>_mcEncoderMark</i>) as the trigger conditions was executed for an axis that is mapped to an OMRON GXEC02□□ EtherCAT Encoder slave. 			○			page 3-567
54200000 hex	Electronic Gear Ratio Numerator Setting Out of Range	The parameter specified for the <i>RatioNumerator</i> input variable to a motion control instruction is out of range.	<ul style="list-style-type: none"> Instruction input parameter exceeded the valid range of the input variable. 			○			page 3-568
54210000 hex	Electronic Gear Ratio Denominator Setting Out of Range	The parameter specified for the <i>RatioDenominator</i> input variable to a motion control instruction is out of range.	<ul style="list-style-type: none"> Instruction input parameter exceeded the valid range of the input variable. 			○			page 3-568
54220000 hex	Target Velocity Setting Out of Range	The parameter specified for the <i>Velocity</i> input variable to a motion control instruction is out of range.	<ul style="list-style-type: none"> Instruction input parameter exceeded the valid range of the input variable. 			○			page 3-569
54230000 hex	Acceleration Setting Out of Range	The parameter specified for the <i>Acceleration</i> input variable to a motion control instruction is out of range.	<ul style="list-style-type: none"> Instruction input parameter exceeded the valid range of the input variable. 			○			page 3-569

Event code	Event name	Meaning	Assumed cause	Level					Reference
				M a j	P r t	M i n	O b s	I n f o	
54240000 hex	Deceleration Setting Out of Range	The parameter specified for the <i>Deceleration</i> input variable to a motion control instruction is out of range.	<ul style="list-style-type: none"> Instruction input parameter exceeded the valid range of the input variable. 			○			page 3-570
54250000 hex	Jerk Setting Out of Range	The parameter specified for the <i>Jerk</i> input variable to a motion control instruction is out of range.	<ul style="list-style-type: none"> Instruction input parameter exceeded the valid range of the input variable. 			○			page 3-570
54270000 hex	Torque Ramp Setting Out of Range	The parameter specified for the <i>TorqueRamp</i> input variable to a motion control instruction is out of range.	<ul style="list-style-type: none"> Instruction input parameter exceeded the valid range of the input variable. 			○			page 3-571
54280000 hex	Master Coefficient Scaling Out of Range	The parameter specified for the <i>MasterScaling</i> input variable to a motion control instruction is out of range.	<ul style="list-style-type: none"> Instruction input parameter exceeded the valid range of the input variable. 			○			page 3-571
54290000 hex	Slave Coefficient Scaling Out of Range	The parameter specified for the <i>SlaveScaling</i> input variable to a motion control instruction is out of range.	<ul style="list-style-type: none"> Instruction input parameter exceeded the valid range of the input variable. 			○			page 3-572
542A0000 hex	Feeding Velocity Setting Out of Range	The parameter specified for the <i>FeedVelocity</i> input variable to a motion control instruction is out of range.	<ul style="list-style-type: none"> The Feed Velocity (input variable <i>FeedVelocity</i>) is still at the default (0). 			○			page 3-572
542B0000 hex	Buffer Mode Selection Out of Range	The parameter specified for the <i>BufferMode</i> input variable to a motion control instruction is out of range.	<ul style="list-style-type: none"> Instruction input parameter exceeded the valid range of the input variable. 			○			page 3-573
542C0000 hex	Coordinate System Selection Out of Range	The parameter specified for the <i>CoordSystem</i> input variable to a motion control instruction is out of range.	<ul style="list-style-type: none"> Instruction input parameter exceeded the valid range of the input variable. 			○			page 3-573

Event code	Event name	Meaning	Assumed cause	Level					Reference
				M a j	P r t	M i n	O b s	I n f o	
542D0000 hex	Circular Interpolation Mode Selection Out of Range	The parameter specified for the <i>CircMode</i> input variable to a motion control instruction is out of range.	<ul style="list-style-type: none"> Instruction input parameter exceeded the valid range of the input variable. 			○			page 3-574
542E0000 hex	Direction Selection Out of Range	The parameter specified for the <i>Direction</i> input variable to a motion control instruction is out of range.	<ul style="list-style-type: none"> Instruction input parameter exceeded the valid range of the input variable. 			○			page 3-574
542F0000 hex	Path Selection Out of Range	The parameter specified for the <i>PathChoice</i> input variable to a motion control instruction is out of range.	<ul style="list-style-type: none"> Instruction input parameter exceeded the valid range of the input variable. 			○			page 3-575
54300000 hex	Position Type Selection Out of Range	The parameter specified for the <i>ReferenceType</i> input variable to a motion control instruction is out of range.	<ul style="list-style-type: none"> Instruction input parameter exceeded the valid range of the input variable. 			○			page 3-575
54310000 hex	Travel Mode Selection Out of Range	The parameter specified for the <i>MoveMode</i> input variable to a motion control instruction is out of range.	<ul style="list-style-type: none"> Instruction input parameter exceeded the valid range of the input variable. 			○			page 3-576
54320000 hex	Transition Mode Selection Out of Range	The parameter specified for the <i>TransitionMode</i> input variable to a motion control instruction is out of range.	<ul style="list-style-type: none"> Instruction input parameter exceeded the valid range of the input variable. <i>_mcAborting</i> or <i>_mcBuffered</i> was specified for <i>BufferMode</i> and <i>_mcTMCornerSuperimposed</i> was specified for <i>TransitionMode</i>. 			○			page 3-577
54330000 hex	Continue Method Selection Out of Range	The value of the reserved input variable <i>Continuous</i> to a motion control instruction changed.	<ul style="list-style-type: none"> The value of the reserved input variable <i>Continuous</i> changed. 			○			page 3-577
54340000 hex	Combine Mode Selection Out of Range	The parameter specified for the <i>CombineMode</i> input variable to a motion control instruction is out of range.	<ul style="list-style-type: none"> Instruction input parameter exceeded the valid range of the input variable. 			○			page 3-578

Event code	Event name	Meaning	Assumed cause	Level					Reference
				M a j	P r t	M i n	O b s	I n f o	
54350000 hex	Synchroni- zation Start Condition Selection Out of Range	The parameter speci- fied for the <i>LinkOption</i> input vari- able to a motion con- trol instruction is out of range.	<ul style="list-style-type: none"> Instruction input parameter ex- ceeded the valid range of the input variable. 			○			page 3-578
54360000 hex	Master and Slave De- fined as Same Axis	The same axis is specified for the <i>Master</i> and <i>Slave</i> in- put variables to a mo- tion control instruc- tion.	<ul style="list-style-type: none"> The parameter is the same for the <i>Master</i> and <i>Slave</i> input variables to the instruction. 			○			page 3-579
54370000 hex	Master and Auxiliary De- fined as Same Axis	The same axis is specified for the <i>Master</i> and <i>Auxiliary</i> input variables to a motion control in- struction.	<ul style="list-style-type: none"> The parameter is the same for the <i>Master</i> and <i>Auxiliary</i> input variables to the instruction. 			○			page 3-579
54380000 hex	Master/ Slave Axis Numbers Not in As- cending Or- der	The axis numbers specified for the <i>Master</i> and <i>Slave</i> in- put variables to a mo- tion control instruction are not in ascending order.	<ul style="list-style-type: none"> The parameters for the <i>Master</i> and <i>Slave</i> input variables to the instruction were not in as- cending order when <i>_mcLatestCommand</i> was specified for the <i>ReferenceType</i> input variable to the instruction. 			○			page 3-580
54390000 hex	Incorrect Cam Table Specification	The parameter speci- fied for the <i>CamTable</i> input variable to a motion control in- struction is out of range.	<ul style="list-style-type: none"> Something other than a cam data variable was specified for the <i>CamTable</i> input variable to the instruction. 			○			page 3-580

Event code	Event name	Meaning	Assumed cause	Level					Reference
				M a j	P r t	M i n	O b s	I n f o	
543A0000 hex	Synchroni- zation Stop- ped	A synchronized control motion control instruction was executed, but conditions required for execution were not met.	<ul style="list-style-type: none"> The MC_CamOut (End Cam Operation) instruction was executed even though the MC_CamIn (Start Cam Operation) or MC_CamInCurve (Start Cam Operation With Specified Curve) instruction is not being executed. The MC_GearOut (End Gear Operation) instruction was executed even though the MC_GearIn (Start Gear Operation), the MC_GearInPos (Positioning Gear Operation), or MC_GearInPos2 (Positioning Gear Operation2) instruction is not being executed. The MC_Phasing (Shift Master Axis Phase) instruction was executed even though the MC_CamIn (Start Cam Operation), MC_CamInCurve (Start Cam Operation With Specified Curve), MC_GearIn (Start Gear Operation), MC_GearInPos (Positioning Gear Operation), MC_GearInPos2 (Positioning Gear Operation2), or MC_MoveLink (Synchronous Positioning) instruction is not being executed. 						page 3-581
543B0000 hex	Motion Control Instruction Re-execution Disabled	An attempt was made to re-execute a motion control instruction that cannot be re-executed.	<ul style="list-style-type: none"> A motion control instruction that cannot be re-executed was re-executed. 						page 3-583
543C0000 hex	Motion Control Instruction Multi-execution Disabled	Multiple functions that cannot be executed simultaneously were executed for the same target (MC common, axis, or axes group).	<ul style="list-style-type: none"> Multiple functions that cannot be executed simultaneously were executed for the same target (MC common, axis, or axes group). 						page 3-584
543D0000 hex	Instruction Not Allowed for Encoder Axis Type	An operation instruction was executed for an encoder axis.	<ul style="list-style-type: none"> An operation instruction was executed for an encoder axis. 						page 3-584

Event code	Event name	Meaning	Assumed cause	Level					Reference
				M a j	P r t	M i n	O b s	I n f o	
543E0000 hex	Instruction Cannot Be Executed during Multi-axes Coordinated Control	<ul style="list-style-type: none"> An operation instruction was executed for an axis or an axes group that was in a coordinated multi-axes motion. A robot instruction that you cannot use for an axes group in a GroupEnable state was executed. 	<ul style="list-style-type: none"> An operation instruction was executed for an axis or an axes group that was in a coordinated multi-axes motion. The MC_SetKinTransform instruction was executed for an axes group in a GroupEnable state. 						page 3-585
543F0000 hex	Multi-axes Coordinated Control Instruction Executed for Disabled Axes Group	A multi-axes coordinated control instruction was executed for an axes group that was in a GroupDisable state.	<ul style="list-style-type: none"> A multi-axes coordinated control instruction was executed for an axes group that was in a GroupDisable state. One of the following instructions was executed for an axes group that was in a GroupDisable state. <ul style="list-style-type: none"> MC_MoveTimeAbsolute MC_SyncLinearConveyor MC_SyncOut MC_RobotJog 						page 3-586
54400000 hex	Axes Group Cannot Be Enabled	Execution of the MC_GroupEnable (Enable Axes Group) instruction failed.	<ul style="list-style-type: none"> When the MC_GroupEnable (Enable Axes Group) instruction was executed, there was a composition axis that was not stopped. When the MC_GroupEnable (Enable Axes Group) instruction was executed, there was a composition axis for which the MC_TouchProbe (Enable External Latch) instruction was being executed. 						page 3-587
54410000 hex	Impossible Axis Operation Specified when the Servo is OFF	An operation instruction was executed for an axis for which the Servo is OFF.	<ul style="list-style-type: none"> An operation instruction was executed for an axis for which the Servo is OFF. Home was preset with the MC_Home or MC_HomeWithParameter instruction for an axis for which EtherCAT process data communications are not established. 						page 3-588

Event code	Event name	Meaning	Assumed cause	Level					Reference
				M a j	P r t	M i n	O b s	I n f o	
54420000 hex	Composition Axis Stopped Error	A motion instruction was executed for an axes group while the MC_Stop instruction was being executed for a composition axis.	<ul style="list-style-type: none"> A motion instruction was executed for an axes group while the MC_Stop instruction was being executed for a composition axis. 			○			page 3-589
54430000 hex	Motion Control Instruction Multi-execution Buffer Limit Exceeded	The number of motion control instructions that is buffered for Buffered or Blending Buffer Modes exceeded the buffer limit.	<ul style="list-style-type: none"> An axis instruction was executed when there was already a current instruction and a buffered instruction for the same axis. An axes group instruction was executed when there was already eight current instructions and buffered instructions for the same axis. 			○			page 3-589
54440000 hex	Insufficient Travel Distance	The specified motion cannot be executed for the deceleration rate or acceleration rate that was specified for multi-execution or re-execution of a positioning instruction.	<ul style="list-style-type: none"> Stopping at the target position was not possible for the specified acceleration/deceleration rate for multi-execution or re-execution of a positioning instruction when the Acceleration/Deceleration Over parameter was set to generate a minor fault and stop. 			○			page 3-590
54450000 hex	Insufficient Travel Distance to Achieve Blending Transit Velocity	There is not sufficient travel distance to accelerate or decelerate to the transit velocity.	<ul style="list-style-type: none"> There was not sufficient travel distance to accelerate the current command to the transit velocity when the Acceleration/Deceleration Over parameter was set to generate a minor fault and stop. 			○			page 3-591
54460000 hex	Move Link Constant Velocity Insufficient Travel Distance	The constant-velocity travel distance of the master axis is less than zero.	<ul style="list-style-type: none"> The constant velocity travel distance of the master axis is below 0 for the MC_MoveLink (Synchronous Positioning) instruction. 			○			page 3-591
54470000 hex	Positioning Gear Operation Insufficient Target Velocity	For the MC_GearInPos (Positioning Gear Operation) or MC_GearInPos2 (Positioning Gear Operation2) instruction, the target velocity of the slave axis is too small to achieve the required velocity.	<ul style="list-style-type: none"> For the MC_GearInPos (Positioning Gear Operation) or MC_GearInPos2 (Positioning Gear Operation2) instruction, the value of the <i>Velocity (Target Velocity)</i> input variable is smaller than the master axis velocity multiplied by the gear ratio when the instruction was executed. 			○			page 3-592

Event code	Event name	Meaning	Assumed cause	Level					Reference
				M a j	P r t	M i n	O b s	I n f o	
54480000 hex	Same Start Point and End Point for Circular Interpolation	The start point and end point were the same when the radius method was specified for the MC_MoveCircular2D (Circular 2D Interpolation) instruction. Or, the start point, end point, and border point were the same when the border point method was specified.	<ul style="list-style-type: none"> The start point and end point were the same when the radius method was specified for the MC_MoveCircular2D (Circular 2D Interpolation) instruction. The start point, end point, and border point were the same when the border point method was specified for the MC_MoveCircular2D (Circular 2D Interpolation) instruction. 			○			page 3-593
54490000 hex	Circular Interpolation Center Specification Position Out of Range	The position specified for the center point exceeded the allowed range when the center method was specified for the MC_MoveCircular2D (Circular 2D Interpolation) instruction.	<ul style="list-style-type: none"> The difference between the distance from the start point to the center point and the distance between the end point to the center point exceeded the permitted value specified for the correction allowance ratio in the axes group settings when the center designation method was specified for the MC_MoveCircular2D (Circular 2D Interpolation) instruction. 			○			page 3-594
544A0000 hex	Instruction Execution Error Caused by Count Mode Setting	An instruction that cannot be used when the Count Mode is set to Rotary Mode was executed for an axis that was set to Rotary Mode.	<ul style="list-style-type: none"> An instruction that cannot be used when the Count Mode is set to Rotary Mode was executed for an axis that was set to Rotary Mode. 			○			page 3-594
544C0000 hex	Parameter Selection Out of Range	The parameter specified for the <i>ParameterNumber</i> input variable to a motion control instruction is out of range.	<ul style="list-style-type: none"> Instruction input parameter exceeded the valid range of the input variable. 			○			page 3-595
544D0000 hex	Stop Method Selection Out of Range	The parameter specified for the <i>StopMode</i> input variable to a motion control instruction is out of range.	<ul style="list-style-type: none"> Instruction input parameter exceeded the valid range of the input variable. 			○			page 3-595
544E0000 hex	Latch ID Selection Out of Range for Trigger Input Condition	The parameter specified for the <i>TriggerInput::LatchID</i> input variable to a motion control instruction is out of range.	<ul style="list-style-type: none"> Instruction input parameter exceeded the valid range of the input variable. 			○			page 3-596

Event code	Event name	Meaning	Assumed cause	Level					Reference
				M a j	P r t	M i n	O b s	I n f o	
544F0000 hex	Setting Out of Range for Writing MC Setting	The parameter specified for the <i>SettingValue</i> input variable to a motion control instruction is out of range.	<ul style="list-style-type: none"> Instruction input parameter exceeded the valid range of the input variable. The parameter specification and the data type of the setting value do not agree. 			○			page 3-596
54500000 hex	Trigger Input Condition Mode Selection Out of Range	The parameter specified for the <i>TriggerInput::Mode</i> input variable to a motion control instruction is out of range.	<ul style="list-style-type: none"> Instruction input parameter exceeded the valid range of the input variable. 			○			page 3-597
54510000 hex	Drive Trigger Signal Selection Out of Range for Trigger Input Condition	The parameter specified for the <i>TriggerInput::InputDrive</i> input variable to a motion control instruction is out of range.	<ul style="list-style-type: none"> Instruction input parameter exceeded the valid range of the input variable. 			○			page 3-597
54530000 hex	Motion Control Instruction Re-execution Disabled (Axis Specification)	An attempt was made to change the parameter for the <i>Axis</i> input variable when re-executing a motion control instruction. (This input variable cannot be changed when re-executing an instruction.)	<ul style="list-style-type: none"> A parameter for an input variable that cannot be changed for re-execution was changed. 			○			page 3-598
54540000 hex	Motion Control Instruction Re-execution Disabled (Buffer Mode Selection)	An attempt was made to change the parameter for the <i>BufferMode</i> input variable when re-executing a motion control instruction. (This input variable cannot be changed when re-executing an instruction.)	<ul style="list-style-type: none"> A parameter for an input variable that cannot be changed for re-execution was changed. 			○			page 3-599
54550000 hex	Motion Control Instruction Re-execution Disabled (Direction Selection)	An attempt was made to change the parameter for the <i>Direction</i> input variable when re-executing a motion control instruction. (This input variable cannot be changed when re-executing an instruction.)	<ul style="list-style-type: none"> An input variable that cannot be changed for re-execution was changed. 			○			page 3-600

Event code	Event name	Meaning	Assumed cause	Level					Reference
				M a j	P r t	M i n	O b s	I n f o	
54560000 hex	Motion Control Instruction Re-execution Disabled (Execution Mode)	An attempt was made to change the parameter for the <i>Periodic</i> input variable when re-executing a motion control instruction. (This input variable cannot be changed when re-executing an instruction.)	<ul style="list-style-type: none"> A parameter for an input variable that cannot be changed for re-execution was changed. 			○			page 3-600
54570000 hex	Motion Control Instruction Re-execution Disabled (Axes Group Specification)	An attempt was made to change the parameter for the <i>AxesGroup</i> input variable when re-executing a motion control instruction. (This input variable cannot be changed when re-executing an instruction.)	<ul style="list-style-type: none"> A parameter for an input variable that cannot be changed for re-execution was changed. 			○			page 3-601
54580000 hex	Motion Control Instruction Re-execution Disabled (Jerk Setting)	An attempt was made to change the parameter for the <i>Jerk</i> input variable when re-executing a motion control instruction. (This input variable cannot be changed when re-executing an instruction.)	<ul style="list-style-type: none"> A parameter for an input variable that cannot be changed for re-execution was changed. 			○			page 3-602
54590000 hex	Motion Control Instruction Re-execution Disabled (Master Axis)	An attempt was made to change the parameter for the <i>Master</i> input variable when re-executing a motion control instruction. (This input variable cannot be changed when re-executing an instruction.)	<ul style="list-style-type: none"> A parameter for an input variable that cannot be changed for re-execution was changed. 			○			page 3-603
545A0000 hex	Motion Control Instruction Re-execution Disabled (MasterOffset)	An attempt was made to change the parameter for the <i>MasterOffset</i> input variable when re-executing a motion control instruction. (This input variable cannot be changed when re-executing an instruction.)	<ul style="list-style-type: none"> A parameter for an input variable that cannot be changed for re-execution was changed. 			○			page 3-603

Event code	Event name	Meaning	Assumed cause	Level					Reference
				M a j	P r t	M i n	O b s	I n f o	
545B0000 hex	Motion Control Instruction Re-execution Disabled (MasterScaling)	An attempt was made to change the parameter for the <i>MasterScaling</i> input variable when re-executing a motion control instruction. (This input variable cannot be changed when re-executing an instruction.)	<ul style="list-style-type: none"> A parameter for an input variable that cannot be changed for re-execution was changed. 			○			page 3-604
545C0000 hex	Motion Control Instruction Re-execution Disabled (MasterStartDistance)	An attempt was made to change the parameter for the <i>MasterStartDistance</i> input variable when re-executing a motion control instruction. (This input variable cannot be changed when re-executing an instruction.)	<ul style="list-style-type: none"> A parameter for an input variable that cannot be changed for re-execution was changed. 			○			page 3-604
545D0000 hex	Motion Control Instruction Re-execution Disabled (Continuous)	An attempt was made to change the parameter for the <i>Continuous</i> input variable when re-executing a motion control instruction. (This input variable cannot be changed when re-executing an instruction.)	<ul style="list-style-type: none"> A parameter for an input variable that cannot be changed for re-execution was changed. 			○			page 3-605
545E0000 hex	Motion Control Instruction Re-execution Disabled (MoveMode)	An attempt was made to change the parameter for the <i>MoveMode</i> input variable when re-executing a motion control instruction. (This input variable cannot be changed when re-executing an instruction.)	<ul style="list-style-type: none"> A parameter for an input variable that cannot be changed for re-execution was changed. 			○			page 3-605
545F0000 hex	Illegal Auxiliary Axis Specification	The axis specified for the <i>Auxiliary</i> input variable to a motion control instruction does not exist.	<ul style="list-style-type: none"> An axis does not exist for the variable specified for the <i>Auxiliary</i> input variable to the instruction. 			○			page 3-606

Event code	Event name	Meaning	Assumed cause	Level					Reference
				M a j	P r t	M i n	O b s	I n f o	
54600000 hex	Illegal Axis Specification	The axis specified for the <i>Axis</i> input variable to a motion control instruction does not exist.	<ul style="list-style-type: none"> An axis does not exist for the variable specified for the <i>Axis</i> input variable to the instruction. 			○			page 3-606
54610000 hex	Illegal Axes Group Specification	The axes group specified for the <i>AxesGroup</i> input variable to a motion control instruction does not exist or is not a used group.	<ul style="list-style-type: none"> An axes group does not exist for the variable specified for the <i>AxesGroup</i> input variable to the instruction. The axes group specified for the <i>AxesGroup</i> input variable to the instruction is not specified as a used group. 			○			page 3-607
54620000 hex	Illegal Master Axis Specification	The axis that is specified for the <i>Master</i> input variable to a motion control instruction is not correct.	<ul style="list-style-type: none"> An axis does not exist for the variable specified for the <i>Master</i> input variable to the instruction. The axis that was specified for the <i>Master</i> input variable to the MC_Phasing (Shift Master Axis Phase) instruction is not the master axis for syncing. The master axis and a slave axis are not assigned to the same task. 			○			page 3-608
54630000 hex	Motion Control Instruction Re-execution Disabled (Slave-Offset)	An attempt was made to change the <i>SlaveOffset</i> input variable when re-executing a motion control instruction. (This input variable cannot be changed when re-executing an instruction.)	<ul style="list-style-type: none"> A parameter for an input variable that cannot be changed for re-execution was changed. 			○			page 3-609
54640000 hex	Motion Control Instruction Re-execution Disabled (Slave-Scaling)	An attempt was made to change the <i>SlaveScaling</i> input variable when re-executing a motion control instruction. (This input variable cannot be changed when re-executing an instruction.)	<ul style="list-style-type: none"> A parameter for an input variable that cannot be changed for re-execution was changed. 			○			page 3-609

Event code	Event name	Meaning	Assumed cause	Level					Reference
				M a j	P r t	M i n	O b s	I n f o	
54650000 hex	Motion Control Instruction Re-execution Disabled (Start-Position)	An attempt was made to change the <i>StartPosition</i> input variable when re-executing a motion control instruction. (This input variable cannot be changed when re-executing an instruction.)	<ul style="list-style-type: none"> A parameter for an input variable that cannot be changed for re-execution was changed. 			○			page 3-610
54660000 hex	Instruction Execution Error with Undefined Home	High-speed homing or an interpolation instruction was executed when home was undefined.	<ul style="list-style-type: none"> High-speed homing was executed when home was undefined. An interpolation instruction was executed for an axes group that includes an axis with no defined home. One of the following robot instructions was executed for an axes group that includes a logical axis with no defined home. MC_SetKinTransform MC_MoveTimeAbsolute MC_SyncLinearConveyor MC_SyncOut MC_GroupMon MC_RobotJog 			○			page 3-611
54670000 hex	Motion Control Instruction Re-execution Disabled (Position Type)	An attempt was made to change the <i>ReferenceType</i> input variable when re-executing a motion control instruction. (This input variable cannot be changed when re-executing an instruction.)	<ul style="list-style-type: none"> A parameter for an input variable that cannot be changed for re-execution was changed. 			○			page 3-612
54680000 hex	Unused Axis Specification for Master Axis	The master axis specified for a motion control instruction is an unused axis.	<ul style="list-style-type: none"> The master axis specified for a motion control instruction is an unused axis. 			○			page 3-612
54690000 hex	First Position Setting Out of Range	The parameter specified for the <i>FirstPosition</i> input variable to a motion control instruction is out of range.	<ul style="list-style-type: none"> Instruction input parameter exceeded the valid range of the input variable. 			○			page 3-613

Event code	Event name	Meaning	Assumed cause	Level					Reference
				M a j	P r t	M i n	O b s	I n f o	
546A0000 hex	Last Position Setting Out of Range	The parameter specified for the <i>LastPosition</i> input variable to a motion control instruction is out of range.	<ul style="list-style-type: none"> Instruction input parameter exceeded the valid range of the input variable. 			○			page 3-613
546B0000 hex	Illegal First/Last Position Size Relationship (Linear Mode)	The parameter specified for the <i>LastPosition</i> input variable to a motion control instruction is smaller than the parameter specified for the <i>FirstPosition</i> input variable.	<ul style="list-style-type: none"> The value of the <i>LastPosition</i> input parameter is less than the value of the <i>FirstPosition</i> input variable for the instruction when the Count Mode is set to Linear Mode. 			○			page 3-614
546C0000 hex	Master Sync Start Position Setting Out of Range	The parameter specified for the <i>MasterSyncPosition</i> input variable to a motion control instruction is out of range.	<ul style="list-style-type: none"> Instruction input parameter exceeded the valid range of the input variable. 			○			page 3-614
546D0000 hex	Slave Sync Start Position Setting Out of Range	The parameter specified for the <i>SlaveSyncPosition</i> input variable to a motion control instruction is out of range.	<ul style="list-style-type: none"> Instruction input parameter exceeded the valid range of the input variable. 			○			page 3-615
546E0000 hex	Duplicate Latch ID for Trigger Input Condition	The same latch ID was specified for more than one motion control instruction.	<ul style="list-style-type: none"> The same latch ID is used simultaneously for more than one of the following instructions: MC_TouchProbe (Enable External Latch) instruction, MC_MoveLink (Synchronous Positioning) instruction, and MC_MoveFeed (Interrupt Feeding) instruction. The MC_AbortTrigger (Disable External Latch) instruction was executed to cancel a latch that was used by an instruction other than the MC_TouchProbe (Enable External Latch) instruction. 			○			page 3-615
546F0000 hex	Jerk Override Factor Out of Range	The parameter specified for the <i>JerkFactor</i> input variable to a motion control instruction is out of range.	<ul style="list-style-type: none"> Instruction input parameter exceeded the valid range of the input variable. 			○			page 3-616

Event code	Event name	Meaning	Assumed cause	Level					Reference
				M a j	P r t	M i n	O b s	I n f o	
54700000 hex	Acceleration/Deceleration Override Factor Out of Range	The parameter specified for the <i>AccFactor</i> input variable to a motion control instruction is out of range.	<ul style="list-style-type: none"> Instruction input parameter exceeded the valid range of the input variable. 			○			page 3-616
54710000 hex	First Position Method Specification Out of Range	The parameter specified for the <i>StartMode</i> input variable to a motion control instruction is out of range.	<ul style="list-style-type: none"> Instruction input parameter exceeded the valid range of the input variable. 			○			page 3-617
54720000 hex	Motion Control Instruction Re-execution Disabled (First Position Method)	An attempt was made to change the <i>StartMode</i> input variable when re-executing a motion control instruction. (This input variable cannot be changed when re-executing an instruction.)	<ul style="list-style-type: none"> A parameter for an input variable that cannot be changed for re-execution was changed. 			○			page 3-617
54740000 hex	Unused Axis Specification for Auxiliary Axis	The axis specified for the <i>Auxiliary</i> input variable to a motion control instruction is an unused axis.	<ul style="list-style-type: none"> The axis specified for the <i>Auxiliary</i> input variable to the instruction is an unused axis. 			○			page 3-618
54750000 hex	Position Gear Value Error	Synchronized motion is not possible for the velocity, acceleration rate, and deceleration rate that were input to a motion control instruction.	<ul style="list-style-type: none"> The specified synchronized motion cannot be performed at the velocity, acceleration rate, or deceleration rate that is input to the instruction. 			○			page 3-618
54760000 hex	Position Gear Master Axis Zero Velocity	The velocity of the master axis was zero when a motion control instruction was started.	<ul style="list-style-type: none"> The velocity of the master axis was 0 when the instruction was started. 			○			page 3-619
54780000 hex	Target Position Setting Out of Range	The parameter specified for the <i>Position</i> input variable to a motion control instruction is out of range.	<ul style="list-style-type: none"> Instruction input parameter exceeded the valid range of the input variable. The target position of a Rotary Mode axis is not within the ring setting range. 			○			page 3-619

Event code	Event name	Meaning	Assumed cause	Level					Reference
				M a j	P r t	M i n	O b s	I n f o	
54790000 hex	Travel Distance Out of Range	The parameter that was specified for the <i>Distance</i> input variable to a motion control instruction is out of range or the target position with the value of <i>Distance</i> added is out of range.	<ul style="list-style-type: none"> The absolute value of the instruction input parameter exceeded the range of 40-bit data when it is converted to pulses. For a Linear Mode axis, the target position with the travel distance added exceeded signed 40-bit data when the absolute value is converted to pulses. 			○			page 3-620
547A0000 hex	Cam Table Start Point Setting Out of Range	The parameter specified for the <i>StartPosition</i> input variable to a motion control instruction is out of range.	<ul style="list-style-type: none"> Instruction input parameter exceeded the valid range of the input variable. 			○			page 3-620
547B0000 hex	Cam Master Axis Following First Position Setting Out of Range	The parameter specified for the <i>MasterStartDistance</i> input variable to a motion control instruction is out of range.	<ul style="list-style-type: none"> Instruction input parameter exceeded the valid range of the input variable. 			○			page 3-621
547C0000 hex	Circular Interpolation Radius Setting Error	It was not possible to create a circular path for the specified radius when the radius method was specified for the MC_MoveCircular2D (Circular 2D Interpolation) instruction.	<ul style="list-style-type: none"> For the MC_MoveCircular2D (Circular 2D Interpolation) instruction, it was not possible to create a circular path for the specified radius when the radius method was specified for circular interpolation. 			○			page 3-621
547D0000 hex	Circular Interpolation Radius Overflow	For the MC_MoveCircular2D (Circular 2D Interpolation) instruction, the radius of the circle exceeded the maximum value for the border point or center specification method.	<ul style="list-style-type: none"> For the MC_MoveCircular2D (Circular 2D Interpolation) instruction, the radius of the circle exceeded 40-bit data when converted to pulses for the border point or center specification method. 			○			page 3-622
547E0000 hex	Circular Interpolation Setting Out of Range	The parameter specified for the <i>CircAxes</i> input variable to a motion control instruction is out of range.	<ul style="list-style-type: none"> Instruction input parameter exceeded the valid range of the input variable. The axes that were specified in <i>CircAxes</i> are not included in the composition axes in the Axes Group Settings. The same axis was specified for both axes of <i>CircAxes</i>. 			○			page 3-622

Event code	Event name	Meaning	Assumed cause	Level					Reference
				M a j	P r t	M i n	O b s	I n f o	
547F0000 hex	Auxiliary/ Slave Axis Numbers Not in As- cending Or- der	The values of the pa- rameters for the <i>Auxiliary</i> and <i>Slave</i> input variables to a motion control in- struction are not in ascending order.	<ul style="list-style-type: none"> The parameters for the <i>Auxiliary</i> and <i>Slave</i> input varia- bles to the instruction are not in ascending order. 			○			page 3-623
54800000 hex	Cam Table Property As- cending Da- ta Error at Update	A phase that was not in ascending order was found during cal- culating the number of valid data. Or, after calculations, the num- ber of valid data is 0.	<ul style="list-style-type: none"> A phase that was not in as- cending order was found when calculating the number of valid data. After calculations, the number of valid data is 0. 			○			page 3-623
54810000 hex	MC_Write Target Out of Range	The parameter speci- fied for the <i>Target</i> in- put variable to a mo- tion control instruction is out of range.	<ul style="list-style-type: none"> Instruction input parameter ex- ceeded the valid range of the input variable. 			○			page 3-624
54820000 hex	Master Trav- el Distance Specification Out of Range	The parameter speci- fied for the <i>MasterDistance</i> input variable to a motion control instruction is out of range.	<ul style="list-style-type: none"> Instruction input parameter ex- ceeded the valid range of the input variable. 			○			page 3-624
54830000 hex	Master Dis- tance in Ac- celeration Specification Out of Range	The parameter speci- fied for the <i>MasterDistanceACC</i> input variable to a motion control in- struction is out of range.	<ul style="list-style-type: none"> Instruction input parameter ex- ceeded the valid range of the input variable. 			○			page 3-625
54840000 hex	Master Dis- tance in De- celeration Specification Out of Range	The parameter speci- fied for the <i>MasterDistanceDEC</i> input variable to a motion control in- struction is out of range.	<ul style="list-style-type: none"> Instruction input parameter ex- ceeded the valid range of the input variable. 			○			page 3-625
54870000 hex	Execution Mode Selec- tion Out of Range	The parameter speci- fied for the <i>ExecutionMode</i> input variable to a motion control instruction is out of range.	<ul style="list-style-type: none"> Instruction input parameter ex- ceeded the valid range of the input variable. 			○			page 3-626
54880000 hex	Permitted Following Error Out of Range	The parameter speci- fied for the <i>PermittedDeviation</i> input variable to a motion control in- struction is out of range.	<ul style="list-style-type: none"> Instruction input parameter ex- ceeded the valid range of the input variable. 			○			page 3-626

Event code	Event name	Meaning	Assumed cause	Level					Reference
				M a j	P r t	M i n	O b s	I n f o	
54890000 hex	Border Point/Center Position/ Radius Specification Out of Range	The parameter specified for the <i>AuxPoint</i> input variable to a motion control instruction is out of range.	<ul style="list-style-type: none"> The value of <i>AuxPoint</i> exceeded signed 40-bit data when converted to pulses for the border point or center specification method. For a radius specifications, the absolute value of <i>AuxPoint[0]</i> exceeded 40-bit data when it is converted to pulses. 			○			page 3-627
548A0000 hex	End Point Specification Out of Range	The parameter specified for the <i>EndPoint</i> input variable to a motion control instruction is out of range.	<ul style="list-style-type: none"> The instruction input parameter exceeded the range of signed 40-bit data when it was converted to pulses. 			○			page 3-627
548B0000 hex	Slave Travel Distance Specification Out of Range	The parameter specified for the <i>SlaveDistance</i> input variable to a motion control instruction is out of range.	<ul style="list-style-type: none"> The instruction input parameter exceeded the range of 40-bit data when it is converted to pulses. 			○			page 3-628
548C0000 hex	Phase Shift Amount Out of Range	The parameter specified for the <i>PhaseShift</i> input variable to a motion control instruction is out of range.	<ul style="list-style-type: none"> The absolute value of the instruction input parameter exceeded the range of 40-bit data when it is converted to pulses. 			○			page 3-628
548D0000 hex	Feeding Distance Out of Range	The parameter specified for the <i>FeedDistance</i> input variable to a motion control instruction is out of range.	<ul style="list-style-type: none"> The absolute value of the instruction input parameter exceeded the range of 40-bit data when it is converted to pulses. 			○			page 3-629
548E0000 hex	Auxiliary and Slave Defined as Same Axis	The same axis was specified for the <i>Auxiliary</i> and <i>Slave</i> input variables to a motion control instruction.	<ul style="list-style-type: none"> The parameter was the same for the <i>Auxiliary</i> and <i>Slave</i> input variables to the instruction. 			○			page 3-629
548F0000 hex	Relative Position Selection Out of Range	The parameter specified for the <i>Relative</i> input variable to a motion control instruction is out of range.	<ul style="list-style-type: none"> Instruction input parameter exceeded the valid range of the input variable. 			○			page 3-630
54900000 hex	Cam Transition Specification Out of Range	The parameter specified for the <i>CamTransition</i> input variable to a motion control instruction is out of range.	<ul style="list-style-type: none"> Instruction input parameter exceeded the valid range of the input variable. 			○			page 3-630

Event code	Event name	Meaning	Assumed cause	Level					Reference
				M a j	P r t	M i n	O b s	I n f o	
54910000 hex	Synchron-ized Control End Mode Selection Out of Range	The parameter speci-fied for the <i>OutMode</i> input variable to a motion control in-struction is out of range.	<ul style="list-style-type: none"> Instruction input parameter ex-ceeded the valid range of the input variable. 			○			page 3-631
54920000 hex	Enable Ex-ternal Latch Instruction Execution Disabled	<i>_mclImmediateStop (Immediate Stop)</i> was specified for the <i>StopMode</i> input vari-able when the MC_TouchProbe (En-able External Latch) instruction was exe-cuted in Drive Mode for an encoder axis.	<ul style="list-style-type: none"> <i>_mclImmediateStop (Immediate Stop)</i> was speci-fied for the <i>StopMode</i> input variable when the MC_TouchProbe (Enable Ex-ternal Latch) instruction was executed in Drive Mode for an encoder axis. 			○			page 3-631
54930000 hex	Master Axis Offset Out of Range	The parameter speci-fied for the <i>MasterOffset</i> input variable to a motion control instruction is out of range.	<ul style="list-style-type: none"> The instruction input paramete-r exceeded the range of signed 40-bit data when it was converted to pulses. 			○			page 3-632
54940000 hex	Slave Axis Offset Out of Range	The parameter speci-fied for the <i>SlaveOffset</i> input vari-able to a motion control instruction is out of range.	<ul style="list-style-type: none"> The instruction input paramete-r exceeded the range of signed 40-bit data when it was converted to pulses. 			○			page 3-632
54950000 hex	Command Current Po-sition Count Selection Out of Range	The parameter speci-fied for the <i>CmdPosMode</i> input variable to a motion control instruction is out of range.	<ul style="list-style-type: none"> Instruction input parameter ex-ceeded the valid range of the input variable. 			○			page 3-633
54960000 hex	Master Axis Gear Ratio Numerator Out of Range	The parameter speci-fied for the <i>RatioNumeratorMast-er</i> input variable to a motion control in-struction is out of range.	<ul style="list-style-type: none"> Instruction input parameter ex-ceeded the valid range of the input variable. 			○			page 3-633
54970000 hex	Master Axis Gear Ratio Denominator Out of Range	The parameter speci-fied for the <i>RatioDenominatorMa-ster</i> input variable to a motion control in-struction is out of range.	<ul style="list-style-type: none"> Instruction input parameter ex-ceeded the valid range of the input variable. 			○			page 3-634

Event code	Event name	Meaning	Assumed cause	Level					Reference
				M a j	P r t	M i n	O b s	I n f o	
54980000 hex	Auxiliary Axis Gear Ratio Numerator Out of Range	The parameter specified for the <i>RatioNumeratorAuxiliary</i> input variable to a motion control instruction is out of range.	<ul style="list-style-type: none"> Instruction input parameter exceeded the valid range of the input variable. 			○			page 3-634
54990000 hex	Auxiliary Axis Gear Ratio Denominator Out of Range	The parameter specified for the <i>RatioDenominatorAuxiliary</i> input variable to a motion control instruction is out of range.	<ul style="list-style-type: none"> Instruction input parameter exceeded the valid range of the input variable. 			○			page 3-635
549A0000 hex	Master Axis Position Type Selection Out of Range	The parameter specified for the <i>ReferenceTypeMaster</i> input variable to a motion control instruction is out of range.	<ul style="list-style-type: none"> Instruction input parameter exceeded the valid range of the input variable. 			○			page 3-635
549B0000 hex	Auxiliary Axis Position Type Selection Out of Range	The parameter specified for the <i>ReferenceTypeAuxiliary</i> input variable to a motion control instruction is out of range.	<ul style="list-style-type: none"> Instruction input parameter exceeded the valid range of the input variable. 			○			page 3-636
549C0000 hex	Target Position Ring Counter Out of Range	Operation is not possible because the target position is out of range for the ring counter of the executed instruction.	<ul style="list-style-type: none"> High-speed homing was executed when 0 was not included in the ring counter. 			○			page 3-636
549D0000 hex (Ver. 1.01 or later)	Axes Group Composition Axis Setting Out of Range	The parameter specified for the <i>Axes</i> input variable to a motion control instruction is out of range.	<ul style="list-style-type: none"> Instruction input parameter exceeded the valid range of the input variable. The composition axes in the axes group are not assigned to the same task. 			○			page 3-637
549E0000 hex (Version 1.04 or later)	Axis Use Setting Out of Range	The parameter specified for the <i>AxisUse</i> input variable to a motion control instruction is out of range.	<ul style="list-style-type: none"> Instruction input parameter exceeded the valid range of the input variable. 			○			page 3-637
57000000 hex (Ver. 1.03 or later)	Homing Parameter Setting Out of Range	The parameter specified for the <i>HomingParameter</i> input variable to a motion control instruction is out of range.	<ul style="list-style-type: none"> Instruction input parameter exceeded the valid range of the input variable. 			○			page 3-638

Event code	Event name	Meaning	Assumed cause	Level					Reference
				M a j	P r t	M i n	O b s	I n f o	
57020000 hex (Version 1.04 or later)	Axis Use Change Error	The MC_ChangeAxisUse (Change Axis Use) instruction was executed when the axis was not stopped or when the command velocity of the axis was saturated.	<ul style="list-style-type: none"> The MC_ChangeAxisUse (Change Axis Use) instruction was executed when the axis was not stopped or when the command velocity of the axis was saturated. 			○			page 3-639
57030000 hex (Ver. 1.06 or later)	Cannot Change Axis Use	The MC_ChangeAxisUse (Change Axis Use) instruction was executed in a way that would cause the maximum number of used real axes or the maximum number of used motion control servo axes to be exceeded.	<ul style="list-style-type: none"> The MC_ChangeAxisUse (Change Axis Use) instruction was executed in a way that would cause the maximum number of used real axes to be exceeded. The MC_ChangeAxisUse (Change Axis Use) instruction was executed in a way that would cause the maximum number of used motion control servo axes to be exceeded. 			○			page 3-640
57200000 hex (Version 1.04 or later)	Motion Control Parameter Setting Error When Changing Axis Use	The motion control parameter settings for the axis that was changed to a used axis are incorrect.	<ul style="list-style-type: none"> The MC_ChangeAxisUse (Change Axis Use) instruction was used to change an unused axis to a used axis, but the motion control parameter settings of the axis are not correct. The power supply was interrupted while a download of the motion control parameter settings was in progress. The non-volatile memory is faulty or the life of the non-volatile memory has been exceeded. 			○			page 3-641

Event code	Event name	Meaning	Assumed cause	Level					Reference
				M a j	P r t	M i n	O b s	I n f o	
57210000 hex (Version 1.04 or later)	Required Process Data Object Not Set When Changing Axis Use	The objects that are required for the axis type of the axis that was changed to a used axis are not set.	<ul style="list-style-type: none"> The objects that are required for the axis type of the axis that was changed to a used axis are not set in the PDO map settings. The power supply was interrupted while a download of the motion control parameter settings was in progress. The non-volatile memory is faulty or the life of the non-volatile memory has been exceeded. The MC_ChangeAxisUse (Change Axis Use) instruction was executed for an axis that Axis Use is set to Unused axis (unchangeable to used axis). 			○			page 3-642
572F0000 hex (Ver. 1.06 or later)	Motion Control Instruction Multi-execution Disabled (Master Axis)	A <i>Master</i> in-out variable that cannot be changed during multi-execution of instructions was changed.	<ul style="list-style-type: none"> A <i>Master</i> in-out variable that cannot be changed during multi-execution of instructions was changed. 			○			page 3-643
57300000 hex (Ver. 1.06 or later)	Motion Control Instruction Multi-execution Disabled (Position Type Selection)	A <i>ReferenceType</i> in-out variable that cannot be changed during multi-execution of instructions was changed.	<ul style="list-style-type: none"> A <i>ReferenceType</i> in-out variable that cannot be changed during multi-execution of instructions was changed. 			○			page 3-643
573A0000 hex (Ver. 1.08 or later)	Cannot Write Axis Parameters	The instruction was executed for an axis that is not an unused axis.	<ul style="list-style-type: none"> The instruction was executed for a used axis or an undefined axis. 			○			page 3-644
573B0000 hex (Ver. 1.08 or later)	Axis Parameter Setting Out of Range	The parameter specified for the <i>AxisParameter</i> input variable to a motion control instruction is outside of the valid range.	<ul style="list-style-type: none"> The parameter specified for the <i>AxisParameter</i> input variable to the instruction is out of range for the input variable. 			○			page 3-645
573C0000 hex (Ver. 1.08 or later)	Cam Property Setting Out of Range	The parameter specified for the <i>CamProperty</i> input variable to a motion control instruction is outside of the valid range.	<ul style="list-style-type: none"> The parameter specified for the <i>CamProperty</i> input variable to the instruction is out of range for the input variable. 			○			page 3-647

Event code	Event name	Meaning	Assumed cause	Level					Reference
				M a j	P r t	M i n	O b s	I n f o	
573D0000 hex (Ver. 1.08 or later)	Cam Node Setting Out of Range	The parameter specified for the <i>CamNodes</i> input variable to a motion control instruction is outside of the valid range.	<ul style="list-style-type: none"> The parameter specified for the <i>CamNodes</i> input variable to the instruction is out of range for the input variable. 			○			page 3-647
573E0000 hex (Ver. 1.08 or later)	Incorrect Cam Node Type Specification	The parameter specified for the <i>CamNodes</i> input variable to a motion control instruction is not an <code>_sMC_CAM_NODE</code> array variable.	<ul style="list-style-type: none"> The parameter specified for the <i>CamNodes</i> input variable to the instruction is not an <code>_sMC_CAM_NODE</code> array variable. 			○			page 3-648
573F0000 hex (Ver. 1.08 or later)	Insufficient Nodes in Cam Table	The array variable of the parameter specified for the <i>CamNodes</i> input variable to a motion control instruction has a <i>Phase</i> value of 0 for element number 0.	<ul style="list-style-type: none"> The array variable of the parameter specified for the <i>CamNodes</i> input variable to the instruction has a <i>Phase</i> (master axis phase) value of 0 for element number 0. 			○			page 3-648
57400000 hex (Ver. 1.08 or later)	Cam Node Master Axis Phase Not in Ascending Order	The values of <i>Phase</i> in the array variable of the parameter specified for the <i>CamNodes</i> input variable to a motion control instruction are not in ascending order according to the element numbers.	<ul style="list-style-type: none"> The values of <i>Phase</i> (master axis phase) in the array variable of the parameter specified for the <i>CamNodes</i> input variable to the instruction are not in ascending order according to the element numbers. Or, truncating the digits that are not effective more than seven digits caused the phases not to be in ascending order. 			○			page 3-649
57410000 hex (Ver. 1.08 or later)	Too Many Data Points in Cam Table	The number of generated cam data points exceeded the number of elements in the array in the cam data variable that is specified for the <i>CamTable</i> input variable to a motion control instruction.	<ul style="list-style-type: none"> The number of cam data points in the generated cam table exceeded the number of elements in the array in the cam data variable that is specified for the <i>CamTable</i> input variable to the instruction. 			○			page 3-650
57420000 hex (Ver. 1.08 or later)	Cam Table Displacement Overflow	<i>Distance</i> in the generated cam table exceeded the range of REAL data.	<ul style="list-style-type: none"> <i>Distance</i> in the generated cam table exceeded the range of REAL data. 			○			page 3-651

Event code	Event name	Meaning	Assumed cause	Level					Reference
				M a j	P r t	M i n	O b s	I n f o	
57430000 hex (Ver. 1.08 or later)	Aborted Cam Table Used	A cam data variable that was aborted during generation was specified for the <i>CamTable</i> input variable to an instruction.	<ul style="list-style-type: none"> A cam data variable that was aborted during generation due to an error in the MC_GenerateCamTable (Generate Cam Table) instruction was specified for the <i>CamTable</i> input variable to the instruction. 				○		page 3-652
57490000 hex (Ver. 1.10 or later)	Execution ID Setting Out of Range	The parameter specified for the <i>ExecID</i> input variable to a motion control instruction is out of range.	<ul style="list-style-type: none"> The parameter specified for the <i>ExecID</i> input variable to the instruction is out of range for the input variable. 				○		page 3-652
574A0000 hex (Ver. 1.10 or later)	Position Off- set Out of Range	The parameter specified for the <i>OffsetPosition</i> input variable to a motion control instruction is out of range.	<ul style="list-style-type: none"> The position offset exceeded the range of signed 40-bit data when it was converted to pulses. 				○		page 3-653
574B0000 hex (Ver. 1.10 or later)	PDS State Transition Command Selection Out of Range	The parameter specified for the <i>TransitionCmd</i> input variable to a motion control instruction is out of range.	<ul style="list-style-type: none"> Instruction input parameter exceeded the valid range of the input variable. 				○		page 3-653
574C0000 hex (Ver. 1.13 or later)	Single-axis Position Control Axis Motion Con- trol Instruc- tion Execu- tion Disabled	An operation instruction was executed for a single-axis position control axis.	An operation instruction was executed for a single-axis position control axis.				○		page 3-654
57510000 hex (Ver. 1.32 or later) [NX102] (Ver. 1.21 or later) [NX701-□□00, NX1P2, NJ501 (excluding NJ501-□□20), NJ301, NJ101-□□00]	Cam Monitor Mode Selec- tion Out of Range	The cam monitor mode selection specified for the <i>CamMonitorMode</i> input variable to a motion control instruction is out of range.	<ul style="list-style-type: none"> The cam monitor mode selection is out of the valid range. 				○		page 3-654
57520000 hex (Ver. 1.32 or later) [NX102] (Ver. 1.21 or later) [NX701-□□00, NX1P2, NJ501 (excluding NJ501-□□20), NJ301, NJ101-□□00]	Data Type of Cam Monitor Values Mis- match	The data type of the cam monitor values specified for the <i>CamMonitorValue</i> input variable to a motion control instruction does not match the cam monitor mode selection.	<ul style="list-style-type: none"> The data type of the variable specified for the cam monitor values does not match the cam monitor mode selection. 				○		page 3-655

Event code	Event name	Meaning	Assumed cause	Level					Reference
				M a j	P r t	M i n	O b s	I n f o	
57530000 hex (Ver.1.70 or later) [Excluding NX701-□□ □□] (Ver. 1.37 or later) [NX701-□□□□]	Sync Mode Setting Out of Range	The parameter speci- fied for the <i>SyncMode</i> input variable to a motion control in- struction is out of range.	<ul style="list-style-type: none"> Instruction input parameter ex- ceeded the valid range of the input variable. 			○			page 3-655
57540000 hex (Ver.1.70 or later) [Excluding NX701-□□ □□] (Ver. 1.37 or later) [NX701-□□□□]	Gear Master Axis Follow- ing First Po- sition Setting Out of Range	The parameter speci- fied for the <i>MasterStartDistance</i> input variable to a motion control in- struction is out of range.	<ul style="list-style-type: none"> Instruction input parameter ex- ceeded the valid range of the input variable. 			○			page 3-656
57550000 hex (Ver.1.70 or later) [Excluding NX701-□□ □□] (Ver. 1.37 or later) [NX701-□□□□]	Torque Limit Mode Set- ting Out of Range	The parameter speci- fied for the <i>TorqueLimitMode</i> in- put variable to a mo- tion control instruction is out of range.	<ul style="list-style-type: none"> Instruction input parameter ex- ceeded the valid range of the input variable. 			○			page 3-656
57560000 hex (Ver.1.70 or later) [Excluding NX701-□□ □□] (Ver. 1.37 or later) [NX701-□□□□]	Insufficient Cam Nodes	The array variable of the parameter speci- fied for the <i>CamNodes</i> input vari- able to a motion con- trol instruction has a <i>Phase</i> value of 0 for element number 0.	<ul style="list-style-type: none"> The array variable of the pa- rameter specified for <i>CamNodes</i> input variable to the instruction has a <i>Phase</i> (master axis phase) value of 0 for element number 0. 			○			page 3-657
57570000 hex (Ver.1.70 or later) [Excluding NX701-□□ □□] (Ver. 1.37 or later) [NX701-□□□□]	Cam Node Start Point Position Out of Range	The parameter speci- fied for the <i>StartPosition</i> input variable to a motion control instruction is out of range.	<ul style="list-style-type: none"> Instruction input parameter ex- ceeded the valid range of the input variable. 			○			page 3-657
57580000 hex (Ver.1.70 or later) [Excluding NX701-□□ □□] (Ver. 1.37 or later) [NX701-□□□□]	Cam Opera- tion Dis- placement Overflow	The displacement calculated for the cam operation is out of range.	<ul style="list-style-type: none"> The absolute value of the product of the cam profile curve displacement and the <i>SlaveScaling</i> input variable when it is converted to pulses exceeds the range of 40-bit data. 			○			page 3-658
57590000 hex (Ver.1.70 or later) [Excluding NX701-□□ □□] (Ver. 1.37 or later) [NX701-□□□□]	Reversing Operation Not Possible	When Slave axis re- versing not possible is specified in the <i>SyncMode</i> input vari- able to a motion con- trol instruction, the slave axis has en- tered an operation pattern causing re- versing motion.	<ul style="list-style-type: none"> When Slave axis reversing not possible is specified in the <i>SyncMode</i> input variable, the slave axis has entered an op- eration causing reversing mo- tion due to the difference in the direction of velocity at the start of catching and during syn- chronization. 			○			page 3-659

Event code	Event name	Meaning	Assumed cause	Level					Reference
				M a j	P r t	M i n	O b s	I n f o	
64400000 hex	Target Position Positive Software Limit Exceeded	The specified position exceeds the positive software limit.	<ul style="list-style-type: none"> The parameter specified for the <i>Position</i> input variable to the instruction is beyond the positive software limit. The starting position is beyond the positive software limit and an instruction that specifies motion in the opposite direction of the software limit was executed. The parameter that was specified for the <i>AuxPoint</i> input variable to a border point MC_MoveCircular2D (Circular 2D Interpolation) instruction is beyond the positive software limit. 				○		page 3-660
64410000 hex	Target Position Negative Software Limit Exceeded	The specified position exceeds the negative software limit.	<ul style="list-style-type: none"> The parameter specified for the <i>Position</i> input variable to the instruction is beyond the negative software limit. The first position is beyond the negative software limit and an instruction that specifies motion in the opposite direction of the software limit was executed. The parameter that was specified for the <i>AuxPoint</i> input variable to a border point MC_MoveCircular2D (Circular 2D Interpolation) instruction is beyond the negative software limit. 				○		page 3-661
64420000 hex	Command Position Overflow/Underflow	Positioning, an instruction in the underflow/overflow direction, or an instruction for which the direction is not specified was executed when there was an underflow/overflow in the command position.	<ul style="list-style-type: none"> One of the following was executed when there was a command position overflow/underflow. A positioning instruction A continuous control instruction in the underflow/overflow direction An instruction for which the direction is not specified (syncing or torque control) 				○		page 3-662

Event code	Event name	Meaning	Assumed cause	Level					Reference
				M a j	P r t	M i n	O b s	I n f o	
64430000 hex	Positive Limit Input	An instruction was executed for a motion in the positive direction when the positive limit input was ON.	<ul style="list-style-type: none"> An instruction for a motion in the positive direction was executed when the positive limit input was ON, or an instruction for a motion with no direction specification was executed when the positive limit input was ON. An axes group motion control instruction was executed when the positive limit input was ON. 			○			page 3-663
64440000 hex	Negative Limit Input	An instruction for a motion in the negative direction was executed when the negative limit input was ON.	<ul style="list-style-type: none"> An instruction for a motion in the negative direction was executed when the negative limit input was ON, or an instruction for a motion with no direction specification was executed when the negative limit input was ON. An axes group motion control instruction was executed when the negative limit input was ON. 			○			page 3-664
74220000 hex	Servo Main Circuits OFF	An attempt was made to turn ON the Servo when the main circuit power supply to the Servo Drive was OFF.	<ul style="list-style-type: none"> An attempt was made to turn ON the Servo when the main circuit power supply to the Servo Drive was OFF. 			○			page 3-664
57220000 hex (Ver. 1.06 or later)	Actual Position Overflow/Underflow	An instruction was executed that is not supported during an actual position overflow/underflow.	<ul style="list-style-type: none"> An instruction was executed that is not supported during an actual position overflow or underflow. 				○		page 3-665
57230000 hex (Ver. 1.06 or later)	Switch Structure Track Number Setting Out of Range	The value of <i>TrackNumber</i> that is specified in the <i>Switches</i> in-out variable to a motion control instruction is out of range.	<ul style="list-style-type: none"> The value of the member of the structure variable that was specified for the in-out variable of the instruction is out of range. 				○		page 3-665
57240000 hex (Ver. 1.06 or later)	Switch Structure First ON Position Setting Out of Range	The value of <i>FirstOnPosition</i> that is specified in the <i>Switches</i> in-out variable to a motion control instruction is out of range.	<ul style="list-style-type: none"> The value of the member of the structure variable that was specified for the in-out variable of the instruction is out of range. 				○		page 3-666

Event code	Event name	Meaning	Assumed cause	Level					Reference
				M a j	P r t	M i n	O b s	I n f o	
57250000 hex (Ver. 1.06 or later)	Switch Structure Last ON Position Setting Out of Range	The value of <i>LastOnPosition</i> that is specified in the <i>Switches</i> in-out variable to a motion control instruction is out of range.	<ul style="list-style-type: none"> The value of the member of the structure variable that was specified for the in-out variable of the instruction is out of range. 				○		page 3-666
57260000 hex (Ver. 1.06 or later)	Switch Structure Axis Direction Out of Range	The value of <i>AxisDirection</i> that is specified in the <i>Switches</i> in-out variable to a motion control instruction is out of range.	<ul style="list-style-type: none"> The value of the member of the structure variable that was specified for the in-out variable of the instruction is out of range. 				○		page 3-667
57270000 hex (Ver. 1.06 or later)	Switch Structure Cam Switch Mode Out of Range	The value of <i>CamSwitchMode</i> that is specified in the <i>Switches</i> in-out variable to a motion control instruction is out of range.	<ul style="list-style-type: none"> The value of the member of the structure variable that was specified for the in-out variable of the instruction is out of range. 				○		page 3-667
57280000 hex (Ver. 1.06 or later)	Switch Structure Duration Setting Out of Range	The value of <i>Duration</i> that is specified in the <i>Switches</i> in-out variable to a motion control instruction is out of range.	<ul style="list-style-type: none"> The value of the member of the structure variable that was specified for the in-out variable of the instruction is out of range. 				○		page 3-668
57290000 hex (Ver. 1.06 or later)	Track Option Structure ON Compensation Setting Out of Range	The value of <i>OnCompensation</i> that is specified in the <i>TrackOptions</i> in-out variable to a motion control instruction is out of range.	<ul style="list-style-type: none"> The value of the member of the structure variable that was specified for the in-out variable of the instruction is out of range. 				○		page 3-668
572A0000 hex (Ver. 1.06 or later)	Track Option Structure OFF Compensation Setting Out of Range	The value of <i>OffCompensation</i> that is specified in the <i>TrackOptions</i> in-out variable to a motion control instruction is out of range.	<ul style="list-style-type: none"> The value of the member of the structure variable that was specified for the in-out variable of the instruction is out of range. 				○		page 3-669
572B0000 hex (Ver. 1.06 or later)	Number of Array Elements in Switch Structure Variable Out of Range	The number of elements in an array in the structure variable that is specified in the <i>Switches</i> in-out variable to a motion control instruction is out of range.	<ul style="list-style-type: none"> The number of elements in an array of the structure variable that was specified for the in-out variable of the instruction is out of range. 				○		page 3-669

Event code	Event name	Meaning	Assumed cause	Level					Reference
				M a j	P r t	M i n	O b s	I n f o	
572C0000 hex (Ver. 1.06 or later)	Number of Array Elements in Output Signal Structure Variable Out of Range	The number of elements in an array in the structure variable that is specified in the <i>Outputs</i> in-out variable to a motion control instruction is out of range.	<ul style="list-style-type: none"> The number of elements in an array of the structure variable that was specified for the in-out variable of the instruction is out of range. 				○		page 3-670
572D0000 hex (Ver. 1.06 or later)	Number of Array Elements in Track Option Structure Variable Out of Range	The number of elements in an array in the structure variable that is specified in the <i>TrackOptions</i> in-out variable to a motion control instruction is out of range.	<ul style="list-style-type: none"> The number of elements in an array of the structure variable that was specified for the in-out variable of the instruction is out of range. 				○		page 3-670
572E0000 hex (Ver. 1.06 or later)	Numbers of Elements in Output Signals and Track Option Arrays Not Matched	The arrays in the structure variables that are specified for the <i>Outputs</i> and <i>TrackOptions</i> in-out variables to a motion control instruction do not have the same number of elements.	<ul style="list-style-type: none"> The arrays in the output signal structure variable and track option structure variable that are specified for the in-out variables to the instruction do not have the same number of elements. 				○		page 3-671
57310000 hex (Ver. 1.06 or later)	Same Track Number Setting in Switch Structure Out of Range	The same track number was specified more than the allowable number of times for the <i>TrackNumber</i> in the <i>Switches</i> in-out variable to a motion control instruction.	<ul style="list-style-type: none"> The same track number was specified more than the allowable number of times for the <i>TrackNumber</i> in the <i>Switches</i> in-out variable to a motion control instruction. 				○		page 3-671

3-6-2 Error Descriptions

General Motion Control

✓ Version Information

For an NX-series CPU Unit, a variable name that starts with `_MC_AX[*]` may start with `_MC1_AX[*]` or `_MC2_AX[*]` instead. Similarly, a variable name that starts with `_MC_GRP[*]` may start with `_MC1_GRP[*]` or `_MC2_GRP[*]` instead.

Event name	Motion Control Function Processing Error		Event code	44210000 hex	
Meaning	A fatal error was detected in the Motion Control Function Module.				
Source	PLC Function Module		Source details	MC Common	Detection timing Continuously
Error attributes	Level	Major fault	Recovery	Cycle the power supply.	Log category System
Effects	User program	Stops.	Operation	It will not be possible to perform axis control. The Controller will stop.	
System-defined variables	Variable		Data type		Name
	None		---		---
Cause and correction	Assumed cause		Correction		Prevention
	An error occurred in the software.		Contact your OMRON representative.		None
Attached information	Attached information 1: System information Attached information 2: System information Attached information 3: System information Attached information 4: System information				
Precautions/Remarks	None				

Event name	Absolute Encoder Home Offset Read Error		Event code	14600000 hex	
Meaning	The absolute encoder current position that is retained during power interruptions was lost.				
Source	Motion Control Function Module		Source details	MC Common	Detection timing At power ON, at Controller reset, or when downloading
Error attributes	Level	Partial fault	Recovery	Error reset	Log category System
Effects	User program	Continues.	Operation	It will not be possible to perform axis control.	
System-defined variables	Variable		Data type		Name
	_MC_COM.PFaultLvl.Active		BOOL		MC Common Partial Fault Occurrence
Cause and correction	Assumed cause		Correction		Prevention
	When the retained variables are backed up with a battery, this event indicates that the life of the battery in the CPU Unit has expired.		Replace the Battery in the CPU Unit, reset the error, and perform homing to define home.		When the retained variables are backed up with a battery, periodically replace the battery in the CPU Unit. For the Battery life, refer to the <i>NX-series CPU Unit Hardware User's Manual (Cat. No. W535)</i> or the <i>NJ-series CPU Unit Hardware User's Manual (Cat. No. W500)</i> .
	An error occurred in the software. Backup memory failure		If this error persists, replace the CPU Unit, reset the error, and perform homing to define home.		None
Attached information	None				
Precautions/Remarks	None				

Event name	Motion Control Parameter Setting Error		Event code	14610000 hex	
Meaning	The MC parameters that were saved in non-volatile memory are missing. Or, an unsupported EtherCAT slave is assigned to the axis.				
Source	Motion Control Function Module		Source details	MC Common	Detection timing At power ON, at Controller reset, or when downloading
Error attributes	Level	Partial fault	Recovery	Cycle the power supply or reset the Controller.	Log category System
Effects	User program	Continues.	Operation	It will not be possible to perform axis control.	
System-defined variables	Variable		Data type		Name
	_MC_COM.PFaultLvl.Active		BOOL		MC Common Partial Fault Occurrence
Cause and correction	Assumed cause		Correction		Prevention
	The power supply to the Controller was interrupted or communications with the Sysmac Studio were disconnected while downloading the motion control parameter settings or clearing memory.		Download the MC parameters from the Sysmac Studio.		Do not turn OFF the power supply during save processing for the parameters.
	An unsupported EtherCAT slave is assigned to the axis.		Cancel axis assignment of the unsupported EtherCAT slave on Sysmac Studio and download the settings.		None
	Non-volatile memory failure		If the error occurs even after the above correction is performed, non-volatile memory has failed. After you replace the CPU Unit, download all settings including the Axis Settings from the Sysmac Studio.		None
Attached information	None				
Precautions/Remarks	None				

Event name	Cam Data Read Error		Event code	14620000 hex		
Meaning	The cam data that was saved in non-volatile memory is missing.					
Source	Motion Control Function Module		Source details	MC Common	Detection timing	At power ON, at Controller reset, or when downloading
Error attributes	Level	Partial fault	Recovery	Cycle the power supply or reset the Controller.	Log category	System
Effects	User program	Continues.	Operation	It will not be possible to perform axis control.		
System-defined variables	Variable		Data type		Name	
	_MC_COM.PFaultLvl.Active		BOOL		MC Common Partial Fault Occurrence	
Cause and correction	Assumed cause		Correction		Prevention	
	Power was interrupted during save processing for cam data		Download the cam data from the Sysmac Studio.		Do not turn OFF the power supply during save processing for the cam data.	
	Non-volatile memory failure		If the error occurs even after the above correction is performed, non-volatile memory has failed. After you replace the CPU Unit, download all settings including the Axis Settings from the Sysmac Studio.		None	
Attached information	None					
Precautions/Remarks	None					

Event name	Required Process Data Object Not Set		Event code	34600000 hex	
Meaning	The object that is required for the axis type is not allocated to PDO.				
Source	Motion Control Function Module		Source details	MC Common	Detection timing At power ON, at Controller reset, or when downloading
Error attributes	Level	Partial fault	Recovery	Cycle the power supply or reset the Controller.	Log category System
Effects	User program	Continues.	Operation	It will not be possible to perform axis control.	
System-defined variables	Variable		Data type		Name
	_MC_COM.PFaultLvl.Active		BOOL		MC Common Partial Fault Occurrence
Cause and correction	Assumed cause		Correction		Prevention
	The required PDOs are not mapped when the axis type is set to a servo axis or encoder axis.		<ul style="list-style-type: none"> Map the PDOs that are required for the relevant axis type. Refer to the description of the relevant Servo Drive Settings in the appendices of the motion control user's manual. When using the NX-series EtherCAT Coupler Unit, set the NX Unit I/O Data Active Status to the I/O data of the EtherCAT Coupler Unit. 		<ul style="list-style-type: none"> Map the PDOs that are required for the axis types that are used. Refer to the description of the relevant Servo Drive Settings in the appendices of the motion control user's manual. When using the NX-series EtherCAT Coupler Unit, set the NX Unit I/O Data Active Status to the I/O data of the EtherCAT Coupler Unit.
	Non-volatile memory failure		If the error occurs even after the above correction is performed, non-volatile memory has failed. After you replace the CPU Unit, download all settings including the Axis Parameter Settings from the Sysmac Studio.		None
Attached information	None				
Precautions/Remarks	None				

Event name	Axis Slave Disabled		Event code	34630000 hex		
Meaning	The slave to which the axis is assigned is disabled.					
Source	Motion Control Function Module		Source details	MC Common	Detection timing	At power ON, at Controller reset, or when downloading
Error attributes	Level	Partial fault	Recovery	Cycle the power supply or reset the Controller.	Log category	System
Effects	User program	Continues.	Operation	It will not be possible to perform axis control.		
System-defined variables	Variable		Data type		Name	
	_MC_COM.PFaultLvl.Active		BOOL		MC Common Partial Fault Occurrence	
Cause and correction	Assumed cause		Correction		Prevention	
	The slave to which the axis is assigned is disabled.		Enable the slave to which the axis is assigned in the EtherCAT settings. If there is no slave, set the axis type to a virtual axis .		Enable the slaves to which axes are assigned in the EtherCAT settings. If there are no slaves, set the axis type to a virtual axis when using an axis in the program.	
Attached information	None					
Precautions/Remarks	None					

Event name	Network Configuration Information Missing for Axis Slave		Event code	34640000 hex		
Meaning	The network configuration information is not registered for the slave to which the axis is assigned.					
Source	Motion Control Function Module		Source details	MC Common	Detection timing	At power ON, at Controller reset, when downloading, when starting Servo ON status, or when changing an unused axis to a used axis
Error attributes	Level	Partial fault	Recovery	Cycle the power supply or reset the Controller.	Log category	System
Effects	User program	Continues.	Operation	It will not be possible to perform axis control.		
System-defined variables	Variable		Data type		Name	
	_MC_COM.PFaultLvl.Active		BOOL		MC Common Partial Fault Occurrence	
Cause and correction	Assumed cause		Correction		Prevention	
	The EtherCAT network configuration information is not registered for the slave to which the axis is assigned.		Register the EtherCAT network configuration information for the slave to which the axis is assigned. Or, set the axis type to a virtual axis .		Register the network configuration information for the slaves to which axes are assigned.	
Attached information	None					
Precautions/Remarks	None					

Event name	Motion Control Initialization Error		Event code	44200000 hex	
Meaning	A fatal error occurred in the system and prevented initialization of the Motion Control Function Module.				
Source	Motion Control Function Module		Source details	MC Common	Detection timing
					At power ON, at Controller reset, or when downloading
Error attributes	Level	Partial fault	Recovery	Cycle the power supply.	Log category
					System
Effects	User program	Continues.	Operation	It will not be possible to perform axis control. It will not be possible to execute motion control instructions.	
System-defined variables	Variable		Data type		Name
	_MC_COM.PFaultLvl.Active		BOOL		MC Common Partial Fault Occurrence
Cause and correction	Assumed cause		Correction		Prevention
	Hardware has failed.		Replace the CPU Unit.		None
Attached information	Attached information 1: System information				
Precautions/Remarks	None				

Event name	Motion Control Period Exceeded		Event code	74200000 hex	
Meaning	Processing for the primary periodic task was not finished within two control periods.				
Source	Motion Control Function Module		Source details	MC Common	Detection timing
					Continuously
Error attributes	Level	Partial fault	Recovery	Error reset	Log category
					System
Effects	User program	Continues.	Operation	Operation is not possible for all axes. Axes in motion stop immediately.	
System-defined variables	Variable		Data type		Name
	_MC_COM.PFaultLvl.Active		BOOL		MC Common Partial Fault Occurrence
Cause and correction	Assumed cause		Correction		Prevention
	The processing load in the primary periodic task is too heavy.		Reduce the amount of processing in the primary periodic task or set the control period to a value that is long enough not to cause operation problems. Check the task period in the Task Period Monitor of the Sysmac Studio.		Write the programs for the primary periodic task so that they perform only the processes required in the specified period. Or, set the period of the primary periodic task to be long enough to complete all required processing.
Attached information	None				
Precautions/Remarks	None				

Event name	Cam Table Save Error		Event code	14630000 hex		
Meaning	Saving a cam table to a file failed.					
Source	Motion Control Function Module		Source details	MC Common	Detection timing	During instruction execution
Error attributes	Level	Minor fault	Recovery	Error reset or cycling power supply	Log category	System
Effects	User program	Continues.	Operation	This error may occur when you read a cam table because the cam data in non-volatile memory may be corrupted.		
System-defined variables	Variable		Data type		Name	
	_MC_COM.MFaultLvl.Active		BOOL		MC Common Minor Fault Occurrence	
Cause and correction	Assumed cause		Correction		Prevention	
	Saving a cam table to a file failed.		Save the file again. If the problem still occurs, non-volatile memory has failed. Replace the CPU Unit.		None	
Attached information	None					
Precautions/Remarks	None					

Event name	Cam Table Data Error during Cam Motion		Event code	54770000 hex		
Meaning	The phases are not in ascending order in the cam table.					
Source	Motion Control Function Module		Source details	Axis	Detection timing	During instruction execution
Error attributes	Level	Minor fault	Recovery	Error reset	Log category	System
Effects	User program	Continues.	Operation	Operation is not possible for relevant axis. Relevant axis decelerates to a stop if it is in motion.		
System-defined variables	Variable		Data type		Name	
	_MC_AX[*].MFaultLvl.Active		BOOL		Axis Minor Fault Occurrence	
Cause and correction	Assumed cause		Correction		Prevention	
	Data containing cam table phases that are not in ascending order was detected during cam motion.		Correct the cam table data so that the phases are in ascending order.		Place the phase data into ascending order in the cam table data.	
	The phase and displacement of the start point in the cam table were not 0 during cam operation.		Correct the cam table data so that the phase and displacement of the start point are 0.		Set the cam table data so that the phase and displacement of the start point are 0.	
	The phase of the end point in the cam table when converted to pulses was not 1 pulse or greater during cam operation.		Correct the cam table data so that the phase of the end point is 1 pulse or greater when it is converted to pulses.		Set the cam table data so that the phase of the end point is 1 pulse or greater when it is converted to pulses.	
Attached information	None					
Precautions/Remarks	None					

Event name	Immediate Stop Instruction Executed		Event code	54850000 hex		
Meaning	An Immediate Stop (MC_ImmediateStop) instruction was executed.					
Source	Motion Control Function Module		Source details	Axis	Detection timing	At instruction execution
Error attributes	Level	Minor fault	Recovery	Error reset	Log category	System
Effects	User program	Continues.	Operation	An immediate stop is performed according to the Stop Mode that is set in the <i>StopMode</i> input variable to the MC_ImmediateStop instruction. If the axis is part of an axes group in motion, all other axes will act according to the Axes Group Stop Mode Selection .		
System-defined variables	Variable		Data type		Name	
	_MC_AX[*].MFaultLvl.Active		BOOL		Axis Minor Fault Occurrence	
Cause and correction	Assumed cause		Correction		Prevention	
	An Immediate Stop instruction was executed.		---		---	
Attached information	None					
Precautions/Remarks	None					

Event name	Axes Group Immediate Stop Instruction Executed		Event code	54860000 hex		
Meaning	An Axes Group Immediate Stop (MC_GroupImmediateStop) instruction was executed.					
Source	Motion Control Function Module		Source details	Axes group	Detection timing	At instruction execution
Error attributes	Level	Minor fault	Recovery	Error reset	Log category	System
Effects	User program	Continues.	Operation	An immediate stop is performed for all axes in the axes group according to the Immediate Stop Input Stop Method axis parameter.		
System-defined variables	Variable		Data type		Name	
	_MC_GRP[*].MFaultLvl.Active		BOOL		Axes Group Minor Fault Occurrence	
Cause and correction	Assumed cause		Correction		Prevention	
	A Group Immediate Stop instruction was executed.		---		---	
Attached information	None					
Precautions/Remarks	None					

Event name	Positive Software Limit Exceeded		Event code	64450000 hex	
Meaning	The position exceeded the positive software limit while the axis is in motion.				
Source	Motion Control Function Module		Source details	Axis	Detection timing During instruction execution
Error attributes	Level	Minor fault	Recovery	Error reset	Log category System
Effects	User program	Continues.	Operation	Follows the setting of the Software Limit Function Selection .	
System-defined variables	Variable		Data type		Name
	_MC_AX[*].MFaultLvl.Active		BOOL		Axis Minor Fault Occurrence
Cause and correction	Assumed cause		Correction		Prevention
	The position exceeded the positive software limit.		Find the reason that the software limit was exceeded and make suitable corrections.		(The goal is to enable detecting the software limits when they are exceeded due to unanticipated causes. Preventative measures are not required.)
Attached information	None				
Precautions/Remarks	Whenever you change the positive software limit setting, make sure that the new setting is safe.				

Event name	Negative Software Limit Exceeded		Event code	64460000 hex	
Meaning	The position exceeded the negative software limit while the axis is in motion.				
Source	Motion Control Function Module		Source details	Axis	Detection timing During instruction execution
Error attributes	Level	Minor fault	Recovery	Error reset	Log category System
Effects	User program	Continues.	Operation	Follows the setting of the Software Limit Function Selection .	
System-defined variables	Variable		Data type		Name
	_MC_AX[*].MFaultLvl.Active		BOOL		Axis Minor Fault Occurrence
Cause and correction	Assumed cause		Correction		Prevention
	The position exceeded the negative software limit.		Find the reason that the software limit was exceeded and make suitable corrections.		(The goal is to enable detecting the software limits when they are exceeded due to unanticipated causes. Preventative measures are not required.)
Attached information	None				
Precautions/Remarks	Whenever you change the negative software limit setting, make sure that the new setting is safe.				

Event name	In-position Check Time Exceeded		Event code	64470000 hex		
Meaning	The in-position check was not completed within the monitoring time.					
Source	Motion Control Function Module		Source details	Axis	Detection timing	During instruction execution
Error attributes	Level	Minor fault	Recovery	Error reset	Log category	System
Effects	User program	Continues.	Operation	Operation is not possible for relevant axis. Relevant axis decelerates to a stop if it is in motion.		
System-defined variables	Variable		Data type		Name	
	_MC_AX[*].MFAultLvl.Active		BOOL		Axis Minor Fault Occurrence	
Cause and correction	Assumed cause		Correction		Prevention	
	Time is required to complete positioning.		Determine the cause of the slow positioning and remove the cause of the error. Or, adjust the Servo Drive or adjust the In-position Check Time or In-position Range. Increase the loop gain if you adjust the Servo Drive. However, make sure that you keep the loop gain low enough so that the control does not oscillate.		Remove the cause of poor following performance or oscillation/vibration in the positioning operation as much as possible.	
Attached information	None					
Precautions/Remarks	None					

Event name	Following Error Limit Exceeded		Event code	64480000 hex		
Meaning	The error between the command current position and actual current value exceeded the Following Error Over Value.					
Source	Motion Control Function Module		Source details	Axis	Detection timing	During instruction execution
Error attributes	Level	Minor fault	Recovery	Error reset	Log category	System
Effects	User program	Continues.	Operation	Operation is not possible for relevant axis. Relevant axis decelerates to a stop if it is in motion.		
System-defined variables	Variable		Data type		Name	
	_MC_AX[*].MFAultLvl.Active		BOOL		Axis Minor Fault Occurrence	
Cause and correction	Assumed cause		Correction		Prevention	
	The positioning operation has poor following performance and the actual motion is slower than the command.		Remove the cause of poor following performance in the positioning operation. Or increase the Following Error Over Value within the range that will not create problems.		Remove the cause of poor following performance in the positioning operation as best you can.	
Attached information	None					
Precautions/Remarks	None					

Event name	Immediate Stop Input		Event code	64490000 hex	
Meaning	The immediate stop input turned ON.				
Source	Motion Control Function Module		Source details	Axis	Detection timing Continuously
Error attributes	Level	Minor fault	Recovery	Error reset	Log category System
Effects	User program	Continues.	Operation	According to the Immediate Stop Input Stop Method .	
System-defined variables	Variable		Data type		Name
	_MC_AX[*].MFAultLvl.Active		BOOL		Axis Minor Fault Occurrence
Cause and correction	Assumed cause		Correction		Prevention
	An immediate stop input signal was detected.		Turn OFF the immediate stop input signal.		(The goal is to detect the immediate stop input. Preventative measures are not required.)
	The immediate stop input signal is not connected correctly or the logic setting for the immediate stop input is wrong.		If the error occurs even when the immediate stop input signal is OFF, correct the immediate stop signal connection and logic setting for the immediate stop input. Check the logic settings both in the axis parameters and in the slave settings.		Make sure that the immediate stop signal connection and logic setting for the immediate stop input are correct. Check the logic settings both in the axis parameters and in the slave settings.
Attached information	None				
Precautions/Remarks	You must turn OFF the immediate stop input signal before you reset the error.				

Event name	Positive Limit Input Detected		Event code	644A0000 hex	
Meaning	The positive limit input turned ON.				
Source	Motion Control Function Module		Source details	Axis	Detection timing Continuously
Error attributes	Level	Minor fault	Recovery	Error reset	Log category System
Effects	User program	Continues.	Operation	According to the Limit Input Stop Method .	
System-defined variables	Variable		Data type		Name
	_MC_AX[*].MFaultLvl.Active		BOOL		Axis Minor Fault Occurrence
Cause and correction	Assumed cause		Correction		Prevention
	A positive limit input signal was detected.		Reset the error and move the axis back in the negative direction before it exceeds the limit in the positive direction. If the error occurred during an axes group motion instruction, disable the axes group and then perform the above operation. Find the reason the limit was exceeded and make suitable corrections.		The goal is to detect the positive limit input. Preventative measures are not required. However, be sure not to exceed the positive limit input when making programs.
	The positive limit input signal is not connected correctly or the logic setting for the positive limit input is wrong.		If a positive limit input signal does not occur, correct the connection of the positive limit signal and the logic setting for the positive limit input. Check the logic settings both in the axis parameters and in the slave settings.		Make sure that the positive limit signal connection and logic setting for the positive limit input are correct. Check the logic settings both in the axis parameters and in the slave settings.
Attached information	None				
Precautions/Remarks	None				

Event name	Negative Limit Input Detected		Event code	644B0000 hex		
Meaning	The negative limit input turned ON.					
Source	Motion Control Function Module		Source details	Axis	Detection timing	Continuously
Error attributes	Level	Minor fault	Recovery	Error reset	Log category	System
Effects	User program	Continues.	Operation	According to the Limit Input Stop Method .		
System-defined variables	Variable		Data type		Name	
	_MC_AX[*].MFaultLvl.Active		BOOL		Axis Minor Fault Occurrence	
Cause and correction	Assumed cause		Correction		Prevention	
	A negative limit input signal was detected.		Reset the error and move the axis back in the positive direction before it exceeds the limit in the negative direction. If the error occurred during an axes group motion control instruction, disable the axes group and then perform the above operation. Find the reason the limit was exceeded and make suitable corrections.		The goal is to detect the negative limit input. Preventative measures are not required. However, be sure not to exceed the negative limit input when making programs.	
	The negative limit input signal is not connected correctly or the logic setting for the negative limit input is wrong.		If a negative limit input signal does not occur, correct the connection of the negative limit signal and the logic setting for the negative limit input. Check the logic settings both in the axis parameters and in the slave settings.		Make sure that the negative limit signal connection and logic setting for the negative limit input are correct. Check the logic settings both in the axis parameters and in the slave settings.	
Attached information	None					
Precautions/Remarks	None					

Event name	Illegal Following Error		Event code	64560000 hex		
Meaning	The difference between the command position and the actual current position exceeds the range of 30-bit data when converted to pulses.					
Source	Motion Control Function Module		Source details	Axis	Detection timing	Continuously
Error attributes	Level	Minor fault	Recovery	Error reset	Log category	System
Effects	User program	Continues.	Operation	The Servo for the axis turns OFF.		
System-defined variables	Variable		Data type		Name	
	_MC_AX[*].MFAultLvl.Active		BOOL		Axis Minor Fault Occurrence	
Cause and correction	Assumed cause		Correction		Prevention	
	The command current position was restricted so that the axis velocity would not exceed the axis maximum velocity for the specified travel distance.		Correct the program or correct the electronic gear ratio so that the axis does not exceed the maximum velocity.		Write the program or set the electronic gear ratio so that the axis does not exceed the maximum velocity.	
	Performance of positioning operation is poor and the actual motion is slower than the command.		Remove the cause of poor following performance in the positioning operation.		Remove the cause of poor following performance in the positioning operation as best you can.	
Attached information	None					
Precautions/Remarks	None					

Event name	Servo OFF Error		Event code	64570000 hex		
Meaning	The Servo was turned OFF for an axis due to an axes group error.					
Source	Motion Control Function Module		Source details	Axis	Detection timing	Continuously
Error attributes	Level	Minor fault	Recovery	Error reset	Log category	System
Effects	User program	Continues.	Operation	The Servo for the axis turns OFF.		
System-defined variables	Variable		Data type		Name	
	_MC_AX[*].MFAultLvl.Active		BOOL		Axis Minor Fault Occurrence	
Cause and correction	Assumed cause		Correction		Prevention	
	The Servo was turned OFF for an axis due to an axes group error.		Find the cause of the error and take suitable measures.		None	
Attached information	None					
Precautions/Remarks	This error occurs for axes for which the Servos are turned OFF for an axes group error to interlock the axes so that the Servos cannot be turned ON with the MC_Power (Power Servo) instruction. This error occurs only when an immediate stop of the command value and turning OFF Servo at same time (free-run stop) is specified for the Axes Group Stop Method Selection .					

Event name	Absolute Encoder Current Position Calculation Failed		Event code	64580000 hex		
Meaning	It was not possible to correctly restore the current position from the absolute encoder information that was saved when power was interrupted.					
Source	Motion Control Function Module		Source details	Axis	Detection timing	At power ON, at Controller reset, when downloading, when starting Servo ON status, or when changing an unused axis to a used axis
Error attributes	Level	Minor fault	Recovery	Error reset	Log category	System
Effects	User program	Continues.	Operation	Operation is not possible for relevant axis.		
System-defined variables	Variable		Data type		Name	
	_MC_AX[*].MFaultLvl.Active		BOOL		Axis Minor Fault Occurrence	
Cause and correction	Assumed cause		Correction		Prevention	
	<ul style="list-style-type: none"> The unit conversion settings, the ring counter setting in the Controller, or the ring counter setting in the Servo Drive settings was changed. The position to restore when converted to pulses exceeded the range of signed 40-bit data. 		Reset the error and perform homing. Perform homing near the position where the absolute encoder is set up so that the position to restore does not exceed the range of signed 40-bit data.		<p>Perform homing again if you changed any parameters related to position, such as the modulo maximum position setting value. Perform homing near the position where the absolute encoder is set up so that the position to restore does not exceed the range of signed 40-bit data.</p> <p>Also, do not execute the MC_Power (Power Servo) instruction, change an unused axis to a used axis, or cycle the power supply when the encoder position exceeds the range of signed 40-bit data.</p>	
Attached information	None					
Precautions/Remarks	None					

Event name	Home Undefined during Coordinated Motion		Event code	64590000 hex	
Meaning	Home of the logical axis became undefined during axes group motion or while decelerating to a stop.				
Source	Motion Control Function Module		Source details	Axes group	Detection timing During instruction execution
Error attributes	Level	Minor fault	Recovery	Error reset	Log category System
Effects	User program	Continues.	Operation	The axes group decelerates to a stop.	
System-defined variables	Variable		Data type		Name
	_MC_GRP[*].MFAultLvl.Active		BOOL		Axes Group Minor Fault Occurrence
Cause and correction	Assumed cause		Correction		Prevention
	The command position or actual position overflowed or underflowed for a logical axis in an axes group motion or a logical axis that was decelerating to a stop and the home definition was lost.		Correct the program so that the axis operates within ranges that do not cause overflows or underflows in the command position or actual position.		Write the program so that the axis operates within ranges that do not cause overflows or underflows in the command position or actual position.
	A slave communications error occurred for a logical axis and home became undefined during axes group motion or while decelerating to a stop.		Correct the slave communications error and define home.		None
	A slave for a logical axis left the network or was disabled and home became undefined during axes group motion or while decelerating to a stop.		Connect the disconnected or disabled slave to the network again and define home.		Do not disconnect or disable the slave of a logical axis during axes group motion or while decelerating to a stop.
Attached information	None				
Precautions/Remarks	None				

Event name	Servo Main Circuit Power OFF		Event code	74210000 hex	
Meaning	The main circuit power of the Servo Drive turned OFF while the Servo was ON.				
Source	Motion Control Function Module		Source details	Axis	Detection timing Whenever Servo is ON
Error attributes	Level	Minor fault	Recovery	Error reset	Log category System
Effects	User program	Continues.	Operation	The Servo for the axis turns OFF.	
System-defined variables	Variable		Data type		Name
	_MC_AX[*].MFAultLvl.Active		BOOL		Axis Minor Fault Occurrence
Cause and correction	Assumed cause		Correction		Prevention
	The main circuit power of the Servo Drive was interrupted while the Servo was ON.		Turn ON the main circuit power of the Servo Drive for the axis where the error occurred, reset the error, and then turn ON the Servo.		Turn OFF the Servo, then turn OFF the main circuit power of the Servo Drive.
Attached information	None				
Precautions/Remarks	None				

Event name	Interrupt Feeding Interrupt Signal Missing		Event code	74230000 hex	
Meaning	An interrupt input was not received during execution of an MC_MoveFeed (Interrupt Feeding) instruction.				
Source	Motion Control Function Module		Source details	Axis	Detection timing During instruction execution
Error attributes	Level	Minor fault	Recovery	Error reset	Log category System
Effects	User program	Continues.	Operation	The axis decelerates to a stop.	
System-defined variables	Variable		Data type		Name
	_MC_AX[*].MFAultLvl.Active		BOOL		Axis Minor Fault Occurrence
Cause and correction	Assumed cause		Correction		Prevention
	The latch enabled range specification is invalid.		If an invalid latch enabled range is specified to the instruction, correct it.		Specify a correct latch enabled range based on the relationship between the motion and sensor position.
	There is a problem with the wiring of the interrupt signal.		Correct any problems with the wiring for the interrupt signal for the instruction.		Make sure that the wiring of the interrupt signal is correct.
	The sensor that outputs the interrupt signal has failed.		If neither of the two causes listed above are applicable, the sensor that outputs the interrupt signal has failed. Replace the sensor that outputs the interrupt signal for the instruction where this error occurred.		None
Attached information	None				
Precautions/Remarks	None				

Event name	Homing Opposite Direction Limit Input Detected		Event code	74240000 hex	
Meaning	The limit signal in the direction opposite to the homing direction was detected during a homing operation.				
Source	Motion Control Function Module		Source details	Axis	Detection timing During instruction execution
Error attributes	Level	Minor fault	Recovery	Error reset	Log category System
Effects	User program	Continues.	Operation	The axis stops with the stop method for the homing execution status.	
System-defined variables	Variable		Data type		Name
	_MC_AX[*].MFAultLvl.Active		BOOL		Axis Minor Fault Occurrence
Cause and correction	Assumed cause		Correction		Prevention
	The Operation Selection at Negative Limit Input or Operation Selection at Positive Limit Input parameter is set to No reverse turn.		To prevent errors at the limit inputs, set the Operation Selection at Negative Limit Input and Operation Selection at Positive Limit Input parameters to Reverse turn.		Check to see if any of the conditions that are given as causes exist in advance.
	The location of the homing input signal sensors, homing settings, and homing start position cause a limit input to be reached.		Correct the location of the input signal sensors, homing settings, and homing start position so that a limit input is not reached.		
	The input signal sensor wiring is incorrect or the sensor is faulty.		Correct the wiring of the input signal sensor or replace the sensor.		
Attached information	None				
Precautions/Remarks	None				

Event name	Homing Direction Limit Input Detected		Event code	74250000 hex		
Meaning	The limit signal in the homing direction was detected during a homing operation.					
Source	Motion Control Function Module		Source details	Axis	Detection timing	During instruction execution
Error attributes	Level	Minor fault	Recovery	Error reset	Log category	System
Effects	User program	Continues.	Operation	The axis stops with the stop method for the homing execution status.		
System-defined variables	Variable		Data type		Name	
	_MC_AX[*].MFAultLvl.Active		BOOL		Axis Minor Fault Occurrence	
Cause and correction	Assumed cause		Correction		Prevention	
	The Operation Selection at Negative Limit Input or Operation Selection at Positive Limit Input parameter is set to No reverse turn.		To prevent errors at the limit inputs, set the Operation Selection at Negative Limit Input and Operation Selection at Positive Limit Input parameters to Reverse turn.		Check to see if any of the conditions that are given as causes exist in advance.	
	The location of the homing input signal sensors, homing settings, and homing start position cause a limit input to be reached.		Correct the location of the input signal sensors, homing settings, and homing start position so that a limit input is not reached.			
	The input signal sensor wiring is incorrect or the sensor is faulty.		Correct the wiring of the input signal sensor or replace the sensor.			
Attached information	None					
Precautions/Remarks	None					

Event name	Homing Limit Inputs Detected in Both Directions		Event code	74260000 hex		
Meaning	The limit signals in both directions were detected during a homing operation.					
Source	Motion Control Function Module		Source details	Axis	Detection timing	During instruction execution
Error attributes	Level	Minor fault	Recovery	Error reset	Log category	System
Effects	User program	Continues.	Operation	The axis stops with the stop method for the homing execution status.		
System-defined variables	Variable		Data type		Name	
	_MC_AX[*].MFAultLvl.Active		BOOL		Axis Minor Fault Occurrence	
Cause and correction	Assumed cause		Correction		Prevention	
	The wiring of the limit signal is incorrect.		Correct the wiring of the limit signal.		Check to see if any of the conditions that are given as causes exist in advance.	
	The limit sensor is installed in the wrong location.		Correct the installation locations of the limit sensors so that they do not turn ON at the same time.			
	The contact logic of the limit signal is not correct.		Correct the contact logic (N.C./N.O.) of the limit signal.			
The limit sensor failed.		Replace the limit sensor.				
Attached information	None					
Precautions/Remarks	None					

Event name	Home Proximity/Homing Opposite Direction Limit Input Detected		Event code	74270000 hex	
Meaning	The home proximity input and the limit signal in the direction opposite to the homing direction were detected at the same time during a homing operation.				
Source	Motion Control Function Module		Source details	Axis	Detection timing During instruction execution
Error attributes	Level	Minor fault	Recovery	Error reset	Log category System
Effects	User program	Continues.	Operation	The axis stops with the stop method for the homing execution status.	
System-defined variables	Variable		Data type		Name
	_MC_AX[*].MFAultLvl.Active		BOOL		Axis Minor Fault Occurrence
Cause and correction	Assumed cause		Correction		Prevention Check to see if any of the conditions that are given as causes exist in advance.
	The wiring of the home proximity signal or limit signal is incorrect.		Correct the wiring of the home proximity signal or limit signal.		
	The home proximity sensor or limit sensor is installed in the wrong location.		Correct the installation location of the home proximity sensor or limit sensor so that they do not turn ON at the same time.		
	The contact logic of the home proximity signal or limit signal is not correct.		Correct the contact logic (N.C./N.O.) of the home proximity sensor or limit sensor.		
	The home proximity sensor or limit sensor failed.		Replace the home proximity sensor or limit sensor.		
Attached information	None				
Precautions/Remarks	None				

Event name	Home Proximity/Homing Direction Limit Input Detected		Event code	74280000 hex		
Meaning	The home proximity input and the limit signal in the homing direction were detected at the same time during a homing operation.					
Source	Motion Control Function Module		Source details	Axis	Detection timing	During instruction execution
Error attributes	Level	Minor fault	Recovery	Error reset	Log category	System
Effects	User program	Continues.	Operation	The axis stops with the stop method for the homing execution status.		
System-defined variables	Variable		Data type		Name	
	_MC_AX[*].MFaultLvl.Active		BOOL		Axis Minor Fault Occurrence	
Cause and correction	Assumed cause		Correction		Prevention Check to see if any of the conditions that are given as causes exist in advance.	
	The wiring of the home proximity signal or limit signal is incorrect.		Correct the wiring of the home proximity signal or limit signal.			
	The home proximity sensor or limit sensor is installed in the wrong location.		Correct the installation location of the home proximity sensor or limit sensor so that they do not turn ON at the same time.			
	The contact logic of the home proximity signal or limit signal is not correct.		Correct the contact logic (N.C./N.O.) of the home proximity sensor or limit sensor.			
	The home proximity sensor or limit sensor failed.		Replace the home proximity sensor or limit sensor.			
Attached information	None					
Precautions/Remarks	None					

Event name	Home Input/Homing Opposite Direction Limit Input Detected		Event code	74290000 hex	
Meaning	The home input and the limit signal in the direction opposite to the homing direction were detected at the same time during a homing operation.				
Source	Motion Control Function Module		Source details	Axis	Detection timing
					During instruction execution
Error attributes	Level	Minor fault	Recovery	Error reset	Log category
					System
Effects	User program	Continues.	Operation	The axis stops with the stop method for the homing execution status.	
System-defined variables	Variable		Data type		Name
	_MC_AX[*].MFaultLvl.Active		BOOL		Axis Minor Fault Occurrence
Cause and correction	Assumed cause		Correction		Prevention
	The wiring of the home input signal or limit signal is incorrect.		Correct the wiring of the home input signal or limit signal.		
	The home input sensor or limit sensor is installed in the wrong location.		Correct the installation location of the home input sensor or limit sensor so that they do not turn ON at the same time.		
	The contact logic of the home input signal or limit signal is not correct.		Correct the contact logic (N.C./N.O.) of the home input signal or limit sensor.		
	The home input signal output device or limit sensor failed.		Replace the home input signal output device or limit sensor.		
Attached information	None				
Precautions/Remarks	None				

Event name	Home Input/Homing Direction Limit Input Detected		Event code	742A0000 hex		
Meaning	The home input and the limit signal in the homing direction were detected at the same time during a homing operation.					
Source	Motion Control Function Module		Source details	Axis	Detection timing	During instruction execution
Error attributes	Level	Minor fault	Recovery	Error reset	Log category	System
Effects	User program	Continues.	Operation	The axis stops with the stop method for the homing execution status.		
System-defined variables	Variable		Data type		Name	
	_MC_AX[*].MFAultLvl.Active		BOOL		Axis Minor Fault Occurrence	
Cause and correction	Assumed cause		Correction		Prevention	
	The wiring of the home input signal or limit signal is incorrect.		Correct the wiring of the home input signal or limit signal.		Check to see if any of the conditions that are given as causes exist in advance.	
	The home input sensor or limit sensor is installed in the wrong location.		Correct the installation location of the home input sensor or limit sensor so that they do not turn ON at the same time.			
	The contact logic of the home input signal or limit signal is not correct.		Correct the contact logic (N.C./N.O.) of the home input signal or limit sensor.			
	The home input signal output device or limit sensor failed.		Replace the home input signal output device or limit sensor.			
Attached information	None					
Precautions/Remarks	None					

Event name	Invalid Home Input Mask Distance		Event code	742B0000 hex		
Meaning	The setting of the home input mask distance is not suitable for the MC_Home or MC_HomeWithParameter instruction.					
Source	Motion Control Function Module		Source details	Axis	Detection timing	During instruction execution
Error attributes	Level	Minor fault	Recovery	Error reset	Log category	System
Effects	User program	Continues.	Operation	The axis stops with the stop method for the homing execution status.		
System-defined variables	Variable		Data type		Name	
	_MC_AX[*].MFAultLvl.Active		BOOL		Axis Minor Fault Occurrence	
Cause and correction	Assumed cause		Correction		Prevention	
	The set value of the home input mask distance when the operating mode of the MC_Home instruction is set to Proximity Reverse Turn/Home Input Mask Distance is insufficient to decelerate from the homing velocity to the homing approach velocity.		Check the home input mask distance, homing velocity, and homing approach velocity. Change the settings so that they provide sufficient travel distance to decelerate based on the operating specifications of the MC_Home or MC_HomeWithParameter instruction.		Check the operating specifications for the MC_Home or MC_HomeWithParameter instruction, then set the home input mask distance, homing velocity, and homing approach velocity so that they provide sufficient travel distance to decelerate.	
Attached information	None					
Precautions/Remarks	None					

3 Error Descriptions and Corrections

Event name	No Home Input		Event code	742C0000 hex		
Meaning	There was no home signal input during the homing operation. Or, a limit signal was detected before there was a home input.					
Source	Motion Control Function Module		Source details	Axis	Detection timing	During instruction execution
Error attributes	Level	Minor fault	Recovery	Error reset	Log category	System
Effects	User program	Continues.	Operation	The axis stops with the stop method for the homing execution status.		
System-defined variables	Variable		Data type		Name	
	_MC_AX[*].MFAultLvl.Active		BOOL		Axis Minor Fault Occurrence	
Cause and correction	Assumed cause		Correction		Prevention	
	<ul style="list-style-type: none"> There was no home signal input during the homing operation. A limit signal was detected before there was a home input. 		Check the home input settings and wiring and correct them so that the home signal is input during homing based on the operation specifications of the MC_Home or MC_HomeWithParameter instruction. Also, set the system so that the home signal is detected before the limit signals.		Set the system so that the home signal is input during the homing operation. Make sure that the home signal is detected before a limit signal. Also check to make sure there are no wiring problems with the home input.	
Attached information	None					
Precautions/Remarks	None					

Event name	No Home Proximity Input		Event code	742D0000 hex		
Meaning	There was no home proximity signal input during the homing operation.					
Source	Motion Control Function Module		Source details	Axis	Detection timing	During instruction execution
Error attributes	Level	Minor fault	Recovery	Error reset	Log category	System
Effects	User program	Continues.	Operation	The axis stops with the stop method for the homing execution status.		
System-defined variables	Variable		Data type		Name	
	_MC_AX[*].MFAultLvl.Active		BOOL		Axis Minor Fault Occurrence	
Cause and correction	Assumed cause		Correction		Prevention	
	There was no home proximity signal input during the homing operation when a home proximity input signal was specified.		Check the home proximity input settings and wiring and correct them so that the home proximity signal is input during homing based on the operation specifications of the MC_Home or MC_HomeWithParameter instruction.		Set the system so that the home proximity signal is input during the homing operation. Also check to make sure there are no wiring problems with the home proximity input.	
Attached information	None					
Precautions/Remarks	None					

Event name	Slave Error Detected		Event code	742F 0000 hex		
Meaning	An error was detected for the EtherCAT slave or NX Unit that is allocated to an axis.					
Source	Motion Control Function Module		Source details	Axis	Detection timing	Continuously
Error attributes	Level	Minor fault	Recovery	Error reset	Log category	System
Effects	User program	Continues.	Operation	The Servo for the axis turns OFF.		
System-defined variables	Variable		Data type		Name	
	_MC_AX[*].MFAultLvl.Active		BOOL		Axis Minor Fault Occurrence	
Cause and correction	Assumed cause		Correction		Prevention	
	An error was detected for the EtherCAT slave or NX Unit that is allocated to an axis.		Check the error at the slave and check the slave error code reported in Slave Error Code Report (94220000 hex) and perform the required corrections.		None	
Attached information	None					
Precautions/Remarks	None					

Event name	Axes Group Composition Axis Error		Event code	74300000 hex		
Meaning	An error occurred for an axis in an axes group.					
Source	Motion Control Function Module		Source details	Axes group	Detection timing	Continuously
Error attributes	Level	Minor fault	Recovery	Error reset	Log category	System
Effects	User program	Continues.	Operation	If an immediate stop is performed for one of the composition axes, operation will follow the setting of the Axes Group Stop Method Selection . Otherwise, an interpolated path stop is performed.		
System-defined variables	Variable		Data type		Name	
	_MC_GRP[*].MFAultLvl.Active		BOOL		Axes Group Minor Fault Occurrence	
Cause and correction	Assumed cause		Correction		Prevention	
	An error occurred for an axis in an axes group that was in motion.		Check the error code of the axes in the axes group and remove the cause of the error.		None	
Attached information	None					
Precautions/Remarks	When an axis error occurs, any axes group that contains that axis will not operate.					

Event name	MC Common Error Occurrence		Event code	74330000 hex		
Meaning	An MC common error occurred.					
Source	Motion Control Function Module		Source details	Axis	Detection timing	Continuously
Error attributes	Level	Minor fault	Recovery	Error reset	Log category	System
Effects	User program	Continues.	Operation	Operation is not possible for relevant axis.		
System-defined variables	Variable		Data type		Name	
	_MC_AX[*].MFAultLvl.Active		BOOL		Axis Minor Fault Occurrence	
Cause and correction	Assumed cause		Correction		Prevention	
	Partial fault level MC common error occurred.		Check the MC common error that occurred and remove the cause of the error.		None	
Attached information	None					
Precautions/Remarks	When a partial fault level MC common error occurs, the axis and axis group do not operate.					

Event name	Latch Position Overflow		Event code	74340000 hex		
Meaning	An overflow occurred for the latched position for the MC_TouchProbe (Enable External Latch) instruction.					
Source	Motion Control Function Module		Source details	Axis	Detection timing	During instruction execution
Error attributes	Level	Minor fault	Recovery	Error reset	Log category	System
Effects	User program	Continues.	Operation	The axis decelerates to a stop. The Enable External Latch instruction cannot retrieve the latch position.		
System-defined variables	Variable		Data type		Name	
	_MC_AX[*].MFAultLvl.Active		BOOL		Axis Minor Fault Occurrence	
Cause and correction	Assumed cause		Correction		Prevention	
	An overflow occurred for the latched position for the MC_TouchProbe (Enable External Latch) instruction.		Correct the program so that the axis position does not overflow.		Write the program so that the axis position does not overflow.	
Attached information	None					
Precautions/Remarks	None					

Event name	Latch Position Underflow		Event code	74350000 hex	
Meaning	An underflow occurred for the latched position for the MC_TouchProbe (Enable External Latch) instruction.				
Source	Motion Control Function Module		Source details	Axis	Detection timing During instruction execution
Error attributes	Level	Minor fault	Recovery	Error reset	Log category System
Effects	User program	Continues.	Operation	The axis decelerates to a stop. The Enable External Latch instruction cannot retrieve the latch position.	
System-defined variables	Variable		Data type		Name
	_MC_AX[*].MFAultLvl.Active		BOOL		Axis Minor Fault Occurrence
Cause and correction	Assumed cause		Correction		Prevention
	An underflow occurred for the latched position for the MC_TouchProbe (Enable External Latch) instruction.		Correct the program so that the axis position does not underflow.		Write the program so that the axis position does not underflow.
Attached information	None				
Precautions/Remarks	None				

Event name	Master Sync Direction Error		Event code	74360000 hex	
Meaning	The master axis continued to move in the direction opposite to the sync direction.				
Source	Motion Control Function Module		Source details	Axis	Detection timing During instruction execution
Error attributes	Level	Minor fault	Recovery	Error reset	Log category System
Effects	User program	Continues.	Operation	The axis decelerates to a stop.	
System-defined variables	Variable		Data type		Name
	_MC_AX[*].MFAultLvl.Active		BOOL		Axis Minor Fault Occurrence
Cause and correction	Assumed cause		Correction		Prevention
	The master axis continued to move in the direction opposite to the sync direction of the master and slave axes, resulting in an overflow.		Correct the program so that the movement direction and travel distance of the master axis are in the sync direction after the start of synchronization.		Write the program so that the movement direction and travel distance of the master axis is the sync direction after the start of synchronization.
Attached information	None				
Precautions/Remarks	None				

Event name	Slave Disconnection during Servo ON		Event code	74370000 hex		
Meaning	<p>One of the following occurred while the Servo was ON for the EtherCAT slave or NX Unit that is allocated to an axis.</p> <ul style="list-style-type: none"> • Disconnection or replacement • Disablement • Restart of the NX bus on the NX-series CPU Unit 					
Source	Motion Control Function Module		Source details	Axis	Detection timing	Whenever Servo is ON
Error attributes	Level	Minor fault	Recovery	Error reset	Log category	System
Effects	User program	Continues.	Operation	The Servo for the axis turns OFF.		
System-defined variables	Variable		Data type		Name	
	_MC_AX[*].MFAultLvl.Active		BOOL		Axis Minor Fault Occurrence	
Cause and correction	Assumed cause		Correction		Prevention	
	<p>One of the following occurred while the Servo was ON for the EtherCAT slave or NX Unit that is allocated to an axis.</p> <ul style="list-style-type: none"> • Disconnection or replacement • Disablement • Restart of the NX bus on the NX-series CPU Unit 		Reconnect the EtherCAT slave or NX Unit that is allocated to the axis to the network.		<p>Turn OFF the Servo before you perform any of the following for the EtherCAT slave or NX Unit.</p> <ul style="list-style-type: none"> • Disconnection or replacement • Disablement • Restart of the NX bus on the NX-series CPU Unit 	
Attached information	None					
Precautions/Remarks	None					

Event name	Feed Distance Overflow		Event code	74380000 hex		
Meaning	The target position after the interrupt input was received for the MC_MoveFeed (Interrupt Feeding) instruction overflowed or underflowed.					
Source	Motion Control Function Module		Source details	Axis	Detection timing	During instruction execution
Error attributes	Level	Minor fault	Recovery	Error reset	Log category	System
Effects	User program	Continues.	Operation	The axis decelerates to a stop.		
System-defined variables	Variable		Data type		Name	
	_MC_AX[*].MFAultLvl.Active		BOOL		Axis Minor Fault Occurrence	
Cause and correction	Assumed cause		Correction		Prevention	
	<p>The target position after the interrupt input was received for the MC_MoveFeed (Interrupt Feeding) instruction exceeded the range of signed 40-bit data when converted to pulses.</p>		Correct the input value for the command position in the program. The target value after the interrupt input is received must not exceed the valid range for the number of pulses when it is converted to pulses.		Write the program correctly. The input value for the command position must not cause the target value after the interrupt input is received to exceed the valid range. The valid range is signed 40-bit data for the number of pulses when the target value is converted to pulses.	
Attached information	None					
Precautions/Remarks	None					

Event name	Error in Changing Servo Drive Control Mode		Event code	74390000 hex	
Meaning	Changing the Control Mode was not completed within the specified time.				
Source	Motion Control Function Module		Source details	Axis	Detection timing During instruction execution
Error attributes	Level	Minor fault	Recovery	Error reset	Log category System
Effects	User program	Continues.	Operation	The Servo for the axis turns OFF.	
System-defined variables	Variable		Data type		Name
	_MC_AX[*].MFAultLvl.Active		BOOL		Axis Minor Fault Occurrence
Cause and correction	Assumed cause		Correction		Prevention
	When the MC_SyncMoveVelocity instruction was stopped, the actual current velocity was not reduced to 10% or less of the maximum velocity within 10 seconds for three consecutive periods after a command velocity of 0 was output.		Adjust the commands and load so that an error does not occur.		Adjust the commands and load so that an error does not occur.
	For an OMRON 1S-series Servo Drive or G5-series Servo Drive, the actual current velocity was not reduced to 10% or less of the maximum velocity within 10 seconds for three consecutive periods when the MC_TorqueControl instruction was stopped.				
	Changing the Control Mode of the Servo Drive between CSP, CSV, and CST was not completed within one second after the command was executed.		Check to see if there is an error in the Servo Drive and to see if settings are correct. Correct any problems that are found. When changing the control mode to perform control operations, set the PDO map to reference positions for CSP.		Make sure that there are no errors in the Servo Drives and make sure that the settings are correct. When changing the control mode to perform control operations, set the PDO map to reference positions for CSP.
Attached information	None				
Precautions/Remarks	None				

Event name	Master Axis Position Read Error		Event code	743A0000 hex		
Meaning	The synchronized control instruction was not executed because an error occurred in the position of the master axis of the synchronized control instruction.					
Source	Motion Control Function Module		Source details	Axis	Detection timing	At or during instruction execution
Error attributes	Level	Minor fault	Recovery	Error reset	Log category	System
Effects	User program	Continues.	Operation	Operation is not possible for relevant slave axis. Relevant slave axis decelerates to a stop if it is in motion.		
System-defined variables	Variable		Data type		Name	
	_MC_AX[*].MFaultLvl.Active		BOOL		Axis Minor Fault Occurrence	
Cause and correction	Assumed cause		Correction		Prevention	
	EtherCAT process data communications are not established for the master axis of the synchronized control instruction or the I/O data of the NX Unit cannot be used for control.		If the _EC_PDslavTbl (Process Data Communicating Slave Table) system-defined variable for the EtherCAT master of the master axis is FALSE, investigate the error in the master axis and remove the cause. If the master axis is assigned to an NX Unit, perform the same correction for the process data communicating status of the NX Unit.		If you execute synchronized control instructions after you turn ON the power supply, download data, or reset slave communications error, make sure that the _EC_PDslavTbl (Process Data Communicating Slave Table) system-defined variable for the EtherCAT master is TRUE for the node of the master axis before you execute the synchronized control instruction. If the master axis is assigned to an NX Unit, perform the same correction for the process data communicating status of the NX Unit.	
	The slave of the master axis for the synchronized control instruction was disconnected or disabled.		Check the slave of the master axis and reconnect it if it was disconnected or enable it if it was disabled.		Make sure that the slave of the master axis is not disconnected or disabled during execution of the synchronized control instruction.	
	An Absolute Encoder Current Position Calculation Failed error (64580000 hex) was detected for the master axis of the synchronized control instruction.		See if an Absolute Encoder Current Position Calculation Failed error (64580000 hex) occurred for the master axis and make suitable corrections to restore operation.		Do not use an axis with an Absolute Encoder Current Position Calculation Failed error (64580000 hex) as the master axis in the synchronized control instruction.	
	The master axis for the synchronized control instruction is an unused axis.		Set the master axis to a Used Axis.		Do not change the master axis to an unused axis when executing synchronized control instructions.	
Attached information	None					
Precautions/Remarks	None					

Event name	Auxiliary Axis Position Read Error		Event code	743B0000 hex		
Meaning	The synchronized control instruction was not executed because an error occurred in the position of the auxiliary axis of the synchronized control instruction.					
Source	Motion Control Function Module		Source details	Axis	Detection timing	At or during instruction execution
	Error attributes	Level		Minor fault		Recovery
Effects	User program	Continues.		Operation	Operation is not possible for relevant slave axis. Relevant slave axis decelerates to a stop if it is in motion.	
	System-defined variables	Variable	Data type		Name	
Cause and correction	_MC_AX[*].MFaultLvl.Active		BOOL		Axis Minor Fault Occurrence	
	Assumed cause		Correction		Prevention	
	EtherCAT process data communications are not established for the auxiliary axis of the synchronized control instruction or the I/O data of the NX Unit cannot be used for control.		If the _EC_PDslavTbl (Process Data Communicating Slave Table) system-defined variable for the EtherCAT master of the auxiliary axis is FALSE, investigate the error in the auxiliary axis and remove the cause. If the auxiliary axis is assigned to an NX Unit, perform the same correction for the process data communicating status of the NX Unit.		If you execute synchronized control instructions after you turn ON the power supply, download data, or reset slave communications error, make sure that the _EC_PDslavTbl (Process Data Communicating Slave Table) system-defined variable for the EtherCAT master is TRUE for the node of the auxiliary axis before you execute the synchronized control instruction. If If the auxiliary axis is assigned to an NX Unit, perform the same correction for the process data communicating status of the NX Unit.	
	The slave of the auxiliary axis for the synchronized control instruction was disconnected or disabled.		Check the slave of the auxiliary axis and reconnect if it was disconnected or enable it if it was disabled.		Make sure that the slave of the auxiliary axis is not disconnected or disabled during execution of the synchronized control instruction.	
	An Absolute Encoder Current Position Calculation Failed error (64580000 hex) was detected for the auxiliary axis of the synchronized control instruction.		See if an Absolute Encoder Current Position Calculation Failed error (64580000 hex) occurred for the auxiliary axis and make suitable corrections to restore operation.		Do not use an axis with a Absolute Encoder Current Position Calculation Failed error (64580000 hex) as the auxiliary axis in a synchronized control instruction.	
	The auxiliary axis for the synchronized control instruction is an unused axis.		Set the auxiliary axis to a Used Axis.		Do not change the auxiliary axis to an unused axis when executing synchronized control instructions.	
Attached information	None					
Precautions/Remarks	None					

Event name	EtherCAT Slave Communications Error		Event code	84400000 hex		
Meaning	A communications error occurred for the EtherCAT slave or NX Unit that is allocated to an axis.					
Source	Motion Control Function Module		Source details	Axis	Detection timing	Continuously
Error attributes	Level	Minor fault	Recovery	Error reset	Log category	System
Effects	User program	Continues.	Operation	The Servo for the axis turns OFF.		
System-defined variables	Variable		Data type		Name	
	_MC_AX[*].MFAultLvl.Active		BOOL		Axis Minor Fault Occurrence	
Cause and correction	Assumed cause		Correction		Prevention	
	A communications error occurred for the EtherCAT slave or NX Unit that is allocated to an axis.		Check the event log for the error that occurred in the EtherCAT Master Function Module or NX Bus Function Module. Remove the cause of the error and clear the relevant error.		None	
Attached information	None					
Precautions/Remarks	Even if this error is reset, the error in the EtherCAT Master Function Module or NX Bus Function Module that is connected with the slave or NX Unit allocated to an axis is not reset. This error can be reset without resetting the error in the EtherCAT Master Function Module or NX Bus Function Module, but the axis will still be disabled.					

Event name	Too Many Reset Motion Control Error Instructions		Event code	571D0000 hex*1		
Meaning	There are more than 100 instances of the ResetMCErr (Reset Motion Control Error) instruction.					
Source	Motion Control Function Module		Source details	MC Common	Detection timing	At power ON, Controller reset, download, or online editing
Error attributes	Level	Observation	Recovery	---	Log category	System
Effects	User program	Continues.	Operation	Not affected.		
System-defined variables	Variable		Data type		Name	
	_MC_COM.Obsr.Active		BOOL		MC Common Observation Active	
Cause and correction	Assumed cause		Correction		Prevention	
	There are more than 100 instances of the ResetMCErr (Reset Motion Control Error) instruction declared in the user program. Instances inside function blocks are included.		Correct the user program so that there are not more than 100 instances of the ResetMCErr (Reset Motion Control Error) instruction. Use the same instances, or use the MC_Reset (Reset Axis Error) instruction or the MC_GroupReset (Group Reset) instruction depending on the error.		Write the user program so that there are not more than 100 instances of the ResetMCErr (Reset Motion Control Error) instruction.	
Attached information	None					
Precautions/Remarks	None					

*1. This event occurs for a CPU Unit with unit version between 1.02 and 1.09.

Event name	Following Error Warning			Event code	644C0000 hex	
Meaning	The following error exceeded the Following Error Warning Value.					
Source	Motion Control Function Module		Source details	Axis	Detection timing	During instruction execution
Error attributes	Level	Observation	Recovery	---	Log category	System
Effects	User program	Continues.	Operation	Not affected.		
System-defined variables	Variable		Data type		Name	
	_MC_AX[*].Obsr.Active		BOOL		Axis Observation Occurrence	
Cause and correction	Assumed cause		Correction		Prevention	
	Performance of positioning operation is poor and the actual motion is slower than the command.		Remove the cause of poor following performance in the positioning operation. Or increase the Following Error Warning Value within the range that will not create problems.		Remove the cause of poor following performance in the positioning operation much as possible.	
Attached information	None					
Precautions/Remarks	None					

Event name	Velocity Warning			Event code	644D0000 hex	
Meaning	The command velocity exceeded the velocity warning value.					
Source	Motion Control Function Module		Source details	Axis/axes group	Detection timing	During instruction execution
Error attributes	Level	Observation	Recovery	---	Log category	System
Effects	User program	Continues.	Operation	Not affected.		
System-defined variables	Variable		Data type		Name	
	_MC_AX[*].Obsr.Active		BOOL		Axis Observation Occurrence	
	_MC_GRP[*].Obsr.Active		BOOL		Axes Group Observation Occurrence	
Cause and correction	Assumed cause		Correction		Prevention	
	The command velocity exceeded the velocity warning value.		Find the reason the velocity warning value was exceeded and make suitable corrections. Or increase the Velocity Warning Value within the range that will not create problems.		(The goal is to enable detecting when the velocity warning value is exceeded. Preventative measures are not required.)	
Attached information	None					
Precautions/Remarks	You can change the event level to the minor fault level. If you change the level to the minor fault level, the Recovery column above will be changed to "Error reset" and the Operation column will be "The axis/axes group decelerates to a stop."					

3 Error Descriptions and Corrections

Event name	Acceleration Warning		Event code	644E0000 hex	
Meaning	The command acceleration exceeded the acceleration warning value.				
Source	Motion Control Function Module		Source details	Axis/axes group	Detection timing During instruction execution
Error attributes	Level	Observation	Recovery	---	Log category System
Effects	User program	Continues.	Operation	Not affected.	
System-defined variables	Variable		Data type		Name
	_MC_AX[*].Obsr.Active		BOOL		Axis Observation Occurrence
		_MC_GRP[*].Obsr.Active		BOOL	Axes Group Observation Occurrence
Cause and correction	Assumed cause		Correction		Prevention
	The command acceleration rate exceeded the acceleration warning value.		Find the reason the acceleration warning value was exceeded and make suitable corrections. Or increase the Acceleration Warning Value within the range that will not create problems.		(The goal is to enable detecting when the acceleration warning value is exceeded. Preventative measures are not required.)
Attached information	None				
Precautions/Remarks	You can change the event level to the minor fault level. If you change the level to the minor fault level, the Recovery column above will be changed to "Error reset" and the Operation column will be "The axis/axes group decelerates to a stop."				

Event name	Deceleration Warning		Event code	644F0000 hex	
Meaning	The command deceleration exceeded the deceleration warning value.				
Source	Motion Control Function Module		Source details	Axis/axes group	Detection timing During instruction execution
Error attributes	Level	Observation	Recovery	---	Log category System
Effects	User program	Continues.	Operation	Not affected.	
System-defined variables	Variable		Data type		Name
	_MC_AX[*].Obsr.Active		BOOL		Axis Observation Occurrence
		_MC_GRP[*].Obsr.Active		BOOL	Axes Group Observation Occurrence
Cause and correction	Assumed cause		Correction		Prevention
	The command deceleration rate exceeded the deceleration warning value.		Find the reason the deceleration warning value was exceeded and make suitable corrections. Or increase the Deceleration Warning Value within the range that will not create problems.		(The goal is to enable detecting when the deceleration warning value is exceeded. Preventative measures are not required.)
Attached information	None				
Precautions/Remarks	You can change the event level to the minor fault level. If you change the level to the minor fault level, the Recovery column above will be changed to "Error reset" and the Operation column will be "The axis/axes group decelerates to a stop."				

Event name	Positive Torque Warning		Event code	64500000 hex	
Meaning	The torque command value exceeded the positive torque warning value.				
Source	Motion Control Function Module		Source details	Axis	Detection timing During instruction execution
Error attributes	Level	Observation	Recovery	---	Log category System
Effects	User program	Continues.	Operation	Not affected.	
System-defined variables	Variable		Data type		Name
	_MC_AX[*].Obsr.Active		BOOL		Axis Observation Occurrence
Cause and correction	Assumed cause		Correction		Prevention
	The torque command value exceeded the positive torque warning value.		Find the reason the torque warning value was exceeded and make suitable corrections. Or increase the Positive Torque Warning Value within the range that will not create problems.		(The goal is to enable detecting when the torque warning value is exceeded. Preventative measures are not required.)
Attached information	None				
Precautions/Remarks	You can change the event level to the minor fault level. If you change the level to the minor fault level, the Recovery column above will be changed to "Error reset" and the Operation column will be "The axis/axes group decelerates to a stop."				

Event name	Negative Torque Warning		Event code	64510000 hex	
Meaning	The torque command value exceeded the negative torque warning value.				
Source	Motion Control Function Module		Source details	Axis	Detection timing During instruction execution
Error attributes	Level	Observation	Recovery	---	Log category System
Effects	User program	Continues.	Operation	Not affected.	
System-defined variables	Variable		Data type		Name
	_MC_AX[*].Obsr.Active		BOOL		Axis Observation Occurrence
Cause and correction	Assumed cause		Correction		Prevention
	The torque command value exceeded the negative torque warning value.		Find the reason the torque warning value was exceeded and make suitable corrections. Or increase the Negative Torque Warning Value within the range that will not create problems.		(The goal is to enable detecting when the torque warning value is exceeded. Preventative measures are not required.)
Attached information	None				
Precautions/Remarks	You can change the event level to the minor fault level. If you change the level to the minor fault level, the Recovery column above will be changed to "Error reset" and the Operation column will be "The axis/axes group decelerates to a stop."				

3 Error Descriptions and Corrections

Event name	Command Position Overflow			Event code	64520000 hex
Meaning	The number of pulses for the command position overflowed.				
Source	Motion Control Function Module		Source details	Axis	Detection timing Continuously
Error attributes	Level	Observation	Recovery	---	Log category System
Effects	User program	Continues.	Operation	The position is not updated, but motion continues.	
System-defined variables	Variable		Data type		Name
	_MC_AX[*].Obsr.Active		BOOL		Axis Observation Occurrence
Cause and correction	Assumed cause		Correction		Prevention
	In Linear Mode, the command position when converted to pulses exceeded the upper limit of signed 40-bit data.		Correct the program so that the input value for the command position does not exceed the range for the number of pulses for the instruction. Or, change the electronic gear ratio settings. To recover from the overflow, change the current position or perform the homing operation.		Check the gear ratio setting and the target position setting value, and make sure that the converted number of pulses does not exceed the range of signed 40-bit data.
Attached information	None				
Precautions/Remarks	You can change the event level to the minor fault level. If you change the level to the minor fault level, the Recovery column above will be changed to "Error reset" and the Operation column will be "The axis/axes group decelerates to a stop."				

Event name	Command Position Underflow			Event code	64530000 hex
Meaning	The number of pulses for the command position exceeded the valid range. (It underflowed.)				
Source	Motion Control Function Module		Source details	Axis	Detection timing Continuously
Error attributes	Level	Observation	Recovery	---	Log category System
Effects	User program	Continues.	Operation	The position is not updated, but motion continues.	
System-defined variables	Variable		Data type		Name
	_MC_AX[*].Obsr.Active		BOOL		Axis Observation Occurrence
Cause and correction	Assumed cause		Correction		Prevention
	In Linear Mode, the command position when converted to pulses exceeded the lower limit of signed 40-bit data.		Correct the program so that the input value for the command position does not exceed the pulse number limit for the instruction. Or, change the electronic gear ratio settings. To recover from the underflow, change the current position or perform the homing operation.		Check the gear ratio setting and the target position setting value, and make sure that the converted number of pulses does not exceed the range of signed 40-bit data.
Attached information	None				
Precautions/Remarks	You can change the event level to the minor fault level. If you change the level to the minor fault level, the Recovery column above will be changed to "Error reset" and the Operation column will be "The axis/axes group decelerates to a stop."				

Event name	Actual Position Overflow		Event code	64540000 hex	
Meaning	The number of pulses for the actual position overflowed.				
Source	Motion Control Function Module		Source details	Axis	Detection timing Continuously
Error attributes	Level	Observation	Recovery	---	Log category System
Effects	User program	Continues.	Operation	The position is not updated, but motion continues.	
System-defined variables	Variable		Data type		Name
	_MC_AX[*].Obsr.Active		BOOL		Axis Observation Occurrence
Cause and correction	Assumed cause		Correction		Prevention
	The actual position when converted to pulses exceeded the upper limit of signed 40-bit data.		Correct the program so that the target position is well within the pulse number limit so that the actual position does not exceed the pulse number limit for the instruction. Or, change the electronic gear ratio settings. To recover from the overflow, change the current position or perform the homing operation.		Check the gear ratio setting and the target position setting value, and make sure that the converted number of pulses does not exceed the range of signed 40-bit data. Allow some leeway.
Attached information	None				
Precautions/Remarks	You can change the event level to the minor fault level. If you change the level to the minor fault level, the Recovery column above will be changed to "Error reset" and the Operation column will be "The axis/axes group decelerates to a stop."				

Event name	Actual Position Underflow		Event code	64550000 hex	
Meaning	The number of pulses for the actual position underflowed.				
Source	Motion Control Function Module		Source details	Axis	Detection timing Continuously
Error attributes	Level	Observation	Recovery	---	Log category System
Effects	User program	Continues.	Operation	The position is not updated, but motion continues.	
System-defined variables	Variable		Data type		Name
	_MC_AX[*].Obsr.Active		BOOL		Axis Observation Occurrence
Cause and correction	Assumed cause		Correction		Prevention
	The actual position when converted to pulses exceeded the lower limit of signed 40-bit data.		Correct the program so that the target position is well within the pulse number limit so that the actual position does not exceed the pulse number limit for the instruction. Or, change the electronic gear ratio settings. To recover from the underflow, change the current position or perform the homing operation.		Check the gear ratio setting and the target position setting value, and make sure that the converted number of pulses does not exceed the range of signed 40-bit data. Allow some leeway.
Attached information	None				
Precautions/Remarks	You can change the event level to the minor fault level. If you change the level to the minor fault level, the Recovery column above will be changed to "Error reset" and the Operation column will be "The axis/axes group decelerates to a stop."				

3 Error Descriptions and Corrections

Event name	Slave Observation Detected		Event code	74320000 hex		
Meaning	A warning was detected for an EtherCAT slave or NX Unit.					
Source	Motion Control Function Module		Source details	Axis	Detection timing	Continuously
Error attributes	Level	Observation	Recovery	---	Log category	System
Effects	User program	Continues.	Operation	Not affected.		
System-defined variables	Variable		Data type		Name	
	_MC_AX[*].Obsr.Active		BOOL		Axis Observation Occurrence	
Cause and correction	Assumed cause		Correction		Prevention	
	A warning was detected for the EtherCAT slave or NX Unit that is allocated to an axis.		Check the warning code for the EtherCAT slave and remove the cause of the warning.		None	
Attached information	Attached information 1: Drive warning code					
Precautions/Remarks	You can change the event level to the minor fault level. If you change the level to the minor fault level, the Recovery column above will be changed to "Error reset" and the Operation column will be "The axis/axes group decelerates to a stop."					

Event name	Cannot Execute Save Cam Table Instruction		Event code	743C0000 hex		
Meaning	You cannot save a cam table to a file when non-volatile memory is being accessed by another operation.					
Source	Motion Control Function Module		Source details	MC Common	Detection timing	At instruction execution
Error attributes	Level	Observation	Recovery	---	Log category	System
Effects	User program	Continues.	Operation	Not affected.		
System-defined variables	Variable		Data type		Name	
	_MC_COM.Obsr.Active		BOOL		MC Common Observation Active	
Cause and correction	Assumed cause		Correction		Prevention	
	An attempt was made to execute the MC_SaveCamTable instruction when another operation was accessing the non-volatile memory (e.g., transfer or data trace operation from the Sysmac Studio).		Execute the MC_SaveCamTable instruction again.		None	
Attached information	None					
Precautions/Remarks	None					

Event name	Notice of Insufficient Travel Distance to Achieve Blending Transit Velocity		Event code	94200000 hex		
Meaning	There is not sufficient travel distance to accelerate or decelerate to the transit velocity during blending operation.					
Source	Motion Control Function Module	Source details	Axis/axes group	Detection timing	At multi-execution of instructions	
Error attributes	Level	Observation	Recovery	---	Log category	System
Effects	User program	Continues.	Operation	Not affected.		
System-defined variables	Variable		Data type		Name	
	_MC_AX[*].Obsr.Active		BOOL		Axis Observation Occurrence	
	_MC_GRP[*].Obsr.Active		BOOL		Axes Group Observation Occurrence	
Cause and correction	Assumed cause		Correction		Prevention	
	When the Acceleration/Deceleration Over parameter was set to Use rapid acceleration/deceleration (Blending is changed to Buffered), the results of profile creation caused the acceleration/deceleration rate to be exceeded when blending was specified, so buffered was used.		Set the Acceleration/Deceleration Over parameter to a value other than Use rapid acceleration/deceleration (Blending is changed to Buffered) if you do not want to change to Buffered operation.		Set the Acceleration/Deceleration Over parameter to a value other than Use rapid acceleration/deceleration (Blending is changed to Buffered) if you do not want to change to Buffered operation.	
	Blending was specified, but the target position was already reached, so it was changed to Buffered because the profile could not be created.		If unanticipated operation occurs from the switch to Buffered operation, correct the program so that the causes given at the left do not occur.		If unanticipated operation occurs from the switch to Buffered operation, write the program so that the causes given at the left do not occur.	
Attached information	None					
Precautions/Remarks	You can change the event level to the minor fault level. If you change the level to the minor fault level, the Recovery column above will be changed to "Error reset" and the Operation column will be "The axis/axes group decelerates to a stop."					

Event name	Error Clear from MC Test Run Tab Page		Event code	94210000 hex		
Meaning	An error was cleared from the MC Test Run Pane of the Sysmac Studio.					
Source	Motion Control Function Module	Source details	MC Common	Detection timing	When MC Test Run error is reset	
Error attributes	Level	Information	Recovery	---	Log category	System
Effects	User program	Continues.	Operation	Not affected.		
System-defined variables	Variable		Data type		Name	
	None		---		---	
Cause and correction	Assumed cause		Correction		Prevention	
	An error was cleared from the MC Test Run Pane of the Sysmac Studio.		---		---	
Attached information	Attached information 1: Execution results (0000_0000 hex: All errors reset, 0000_0001 hex: Resetting all errors failed)					
Precautions/Remarks	None					

Event name	Slave Error Code Report		Event code	94220000 hex	
Meaning	The error code was reported by the slave when a Slave Error Detected error occurred.				
Source	Motion Control Function Module		Source details	Axis	Detection timing After Slave Error Detected error (742F0000 hex)
Error attributes	Level	Information	Recovery	---	Log category System
Effects	User program	Continues.	Operation	Not affected.	
System-defined variables	Variable		Data type		Name
	None		---		---
Cause and correction	Assumed cause		Correction		Prevention
	The error code was reported by the slave when a Slave Error Detected error (742F0000 hex) occurred.		This error accompanies a Slave Error Detected error (742F0000 hex). Check the slave error code in the attached information and make the required corrections.		None
Attached information	Attached information 1: Slave error code				
Precautions/Remarks	For an OMRON 1S-series Servo Drive or G5-series Servo Drive, the error code (the main part of the error display number) from the Servo Drive is included in the lower two digits of the attached information. For example, if the attached information is displayed as FF13, the error with display number 13 (Main Circuit Power Supply Undervoltage) occurred in the Servo Drive.				

Motion Control Instructions

This section provides a table of errors (events) that occur for motion control instructions. The upper four digits of the event code give the error code (ErrorID) for the motion control instruction. For descriptions of an error code, refer to the description of the corresponding event code. For example, if the error code for the motion control instruction is 16#3461, refer to the description for event code 34610000 hex.



Precautions for Correct Use

With CPU Unit with unit version 1.10 or later, a variable name that starts with `_MC_AX[*]` may start with `_MC1_AX[*]` or `_MC2_AX[*]` instead. In the same way, a variable name that starts with `_MC_GRP[*]` may start with `_MC1_GRP[*]` or `_MC2_GRP[*]` instead.

Event name	Process Data Object Setting Missing		Event code	34610000 hex	
Meaning	The PDO mapping is not correct.				
Source	Motion Control Function Module		Source details	Axis	Detection timing At instruction execution
Error attributes	Level	Minor fault	Recovery	Error reset	Log category System
Effects	User program	Continues.	Operation	Operation is not possible for relevant axis.	
System-defined variables	Variable		Data type	Name	
	<code>_MC_AX[*].MFaultLvl.Active</code>		BOOL	Axis Minor Fault Occurrence	
Cause and correction	Assumed cause		Correction	Prevention	
	The PDOs that are required for the motion control instruction are not mapped.		Map the PDOs that are required for the instruction. Refer to the <i>Function section</i> of the relevant instruction for the required PDOs.	Map the PDOs that are required for the instructions that are used. Refer to the <i>NJ/NX-series CPU Unit Motion Control User's Manual (Cat. No. W507)</i> for the PDOs (Servo Drive settings) that you must map for each instruction.	
	The relevant instruction was executed for a device that does not have an object that supports the instruction.		Some devices do not support the relevant instruction. Refer to the manual for the target device, check to see if the relevant instruction is supported, and correct the program so that unsupported instructions are not executed.	Refer to the manual for the target device and write the program so that unsupported instructions are not executed.	
	A motion control instruction that specifies phase Z (<code>_mcEncoderMark</code>) as the trigger conditions was executed for an axis that is mapped to an OMRON GXEC02□□ EtherCAT Encoder slave.		Use an external input (<code>_mcEXT</code>) as the trigger conditions for an axis that is mapped to an OMRON GX-EC02□□ EtherCAT Encoder slave.	Use an external input (<code>_mcEXT</code>) as the trigger conditions for an axis that is mapped to an OMRON GX-EC02□□ EtherCAT Encoder slave.	
Attached information	None				
Precautions/Remarks	None				

3 Error Descriptions and Corrections

Event name	Electronic Gear Ratio Numerator Setting Out of Range		Event code	54200000 hex		
Meaning	The parameter specified for the <i>RatioNumerator</i> input variable to a motion control instruction is out of range.					
Source	Motion Control Function Module		Source details	Axis	Detection timing	At instruction execution
Error attributes	Level	Minor fault	Recovery	Error reset	Log category	System
Effects	User program	Continues.	Operation	Operation is not possible for the slave axis. Relevant slave axis decelerates to a stop if it is in motion.		
System-defined variables	Variable	Data type		Name		
	_MC_AX[*].MFAultLvl.Active	BOOL		Axis Minor Fault Occurrence		
Cause and correction	Assumed cause		Correction		Prevention	
	Instruction input parameter exceeded the valid range of the input variable.		Correct the parameter so that the valid range of the input variable is not exceeded for the instruction.		Set the input parameter to the instruction so that the valid range of the input variable is not exceeded.	
Attached information	None					
Precautions/Remarks	None					

Event name	Electronic Gear Ratio Denominator Setting Out of Range		Event code	54210000 hex		
Meaning	The parameter specified for the <i>RatioDenominator</i> input variable to a motion control instruction is out of range.					
Source	Motion Control Function Module		Source details	Axis	Detection timing	At instruction execution
Error attributes	Level	Minor fault	Recovery	Error reset	Log category	System
Effects	User program	Continues.	Operation	Operation is not possible for relevant slave axis. Relevant slave axis decelerates to a stop if it is in motion.		
System-defined variables	Variable	Data type		Name		
	_MC_AX[*].MFAultLvl.Active	BOOL		Axis Minor Fault Occurrence		
Cause and correction	Assumed cause		Correction		Prevention	
	Instruction input parameter exceeded the valid range of the input variable.		Correct the parameter so that the valid range of the input variable is not exceeded for the relevant instruction.		Set the input parameter to the instruction so that the valid range of the input variable is not exceeded.	
Attached information	None					
Precautions/Remarks	None					

Event name	Target Velocity Setting Out of Range		Event code	54220000 hex		
Meaning	The parameter specified for the <i>Velocity</i> input variable to a motion control instruction is out of range.					
Source	Motion Control Function Module		Source details	Axis/axes group	Detection timing	At instruction execution
Error attributes	Level	Minor fault	Recovery	Error reset	Log category	System
Effects	User program	Continues.	Operation	If “axis” is given for the source details, operation is not possible for relevant axis. Relevant axis decelerates to a stop if it is in motion. If “axes group” is given for the source details, operation is not possible for relevant axes group. Relevant axes group decelerates to a stop if it is in motion.		
System-defined variables	Variable	Data type		Name		
	_MC_AX[*].MFaultLvl.Active	BOOL		Axis Minor Fault Occurrence		
	_MC_GRP[*].MFaultLvl.Active	BOOL		Axes Group Minor Fault Occurrence		
Cause and correction	Assumed cause		Correction		Prevention	
	Instruction input parameter exceeded the valid range of the input variable.		Correct the parameter so that the valid range of the input variable is not exceeded for the relevant instruction.		Set the input parameter to the instruction so that the valid range of the input variable is not exceeded.	
Attached information	None					
Precautions/Remarks	None					

Event name	Acceleration Setting Out of Range		Event code	54230000 hex		
Meaning	The parameter specified for the <i>Acceleration</i> input variable to a motion control instruction is out of range.					
Source	Motion Control Function Module		Source details	Axis/axes group	Detection timing	At instruction execution
Error attributes	Level	Minor fault	Recovery	Error reset	Log category	System
Effects	User program	Continues.	Operation	If “axis” is given for the source details, operation is not possible for relevant axis. Relevant axis decelerates to a stop if it is in motion. If “axes group” is given for the source details, operation is not possible for relevant axes group. Relevant axes group decelerates to a stop if it is in motion.		
System-defined variables	Variable	Data type		Name		
	_MC_AX[*].MFaultLvl.Active	BOOL		Axis Minor Fault Occurrence		
	_MC_GRP[*].MFaultLvl.Active	BOOL		Axes Group Minor Fault Occurrence		
Cause and correction	Assumed cause		Correction		Prevention	
	Instruction input parameter exceeded the valid range of the input variable.		Correct the parameter so that the valid range of the input variable is not exceeded for the relevant instruction.		Set the input parameter to the instruction so that the valid range of the input variable is not exceeded.	
Attached information	None					
Precautions/Remarks	None					

Event name	Deceleration Setting Out of Range		Event code	54240000 hex		
Meaning	The parameter specified for the <i>Deceleration</i> input variable to a motion control instruction is out of range.					
Source	Motion Control Function Module		Source details	Axis/axes group	Detection timing	At instruction execution
Error attributes	Level	Minor fault	Recovery	Error reset	Log category	System
Effects	User program	Continues.	Operation	<p>If “axis” is given for the source details, operation is not possible for relevant axis. Relevant axis decelerates to a stop if it is in motion.</p> <p>If “axes group” is given for the source details, operation is not possible for relevant axes group. Relevant axes group decelerates to a stop if it is in motion.</p>		
System-defined variables	Variable		Data type		Name	
	_MC_AX[*].MFAultLvl.Active		BOOL		Axis Minor Fault Occurrence	
	_MC_GRP[*].MFAultLvl.Active		BOOL		Axes Group Minor Fault Occurrence	
Cause and correction	Assumed cause		Correction		Prevention	
	Instruction input parameter exceeded the valid range of the input variable.		Correct the parameter so that the valid range of the input variable is not exceeded for the relevant instruction.		Set the input parameter to the instruction so that the valid range of the input variable is not exceeded.	
Attached information	None					
Precautions/Remarks	None					

Event name	Jerk Setting Out of Range		Event code	54250000 hex		
Meaning	The parameter specified for the <i>Jerk</i> input variable to a motion control instruction is out of range.					
Source	Motion Control Function Module		Source details	Axis/axes group	Detection timing	At instruction execution
Error attributes	Level	Minor fault	Recovery	Error reset	Log category	System
Effects	User program	Continues.	Operation	<p>If “axis” is given for the source details, operation is not possible for relevant axis. Relevant axis decelerates to a stop if it is in motion.</p> <p>If “axes group” is given for the source details, operation is not possible for relevant axes group. Relevant axes group decelerates to a stop if it is in motion.</p>		
System-defined variables	Variable		Data type		Name	
	_MC_AX[*].MFAultLvl.Active		BOOL		Axis Minor Fault Occurrence	
	_MC_GRP[*].MFAultLvl.Active		BOOL		Axes Group Minor Fault Occurrence	
Cause and correction	Assumed cause		Correction		Prevention	
	Instruction input parameter exceeded the valid range of the input variable.		Correct the parameter so that the valid range of the input variable is not exceeded for the relevant instruction.		Set the input parameter to the instruction so that the valid range of the input variable is not exceeded.	
Attached information	None					
Precautions/Remarks	None					

Event name	Torque Ramp Setting Out of Range		Event code	54270000 hex		
Meaning	The parameter specified for the <i>TorqueRamp</i> input variable to a motion control instruction is out of range.					
Source	Motion Control Function Module		Source details	Axis	Detection timing	At instruction execution
Error attributes	Level	Minor fault	Recovery	Error reset	Log category	System
Effects	User program	Continues.	Operation	Operation is not possible for relevant axis. Relevant axis decelerates to a stop if it is in motion.		
System-defined variables	Variable		Data type		Name	
	_MC_AX[*].MFAultLvl.Active		BOOL		Axis Minor Fault Occurrence	
Cause and correction	Assumed cause		Correction		Prevention	
	Instruction input parameter exceeded the valid range of the input variable.		Correct the parameter so that the valid range of the input variable is not exceeded for the relevant instruction.		Set the input parameter to the instruction so that the valid range of the input variable is not exceeded.	
Attached information	None					
Precautions/Remarks	None					

Event name	Master Coefficient Scaling Out of Range		Event code	54280000 hex		
Meaning	The parameter specified for the <i>MasterScaling</i> input variable to a motion control instruction is out of range.					
Source	Motion Control Function Module		Source details	Axis	Detection timing	At instruction execution
Error attributes	Level	Minor fault	Recovery	Error reset	Log category	System
Effects	User program	Continues.	Operation	Operation is not possible for relevant slave axis. Relevant slave axis decelerates to a stop if it is in motion.		
System-defined variables	Variable		Data type		Name	
	_MC_AX[*].MFAultLvl.Active		BOOL		Axis Minor Fault Occurrence	
Cause and correction	Assumed cause		Correction		Prevention	
	Instruction input parameter exceeded the valid range of the input variable.		Correct the parameter so that the valid range of the input variable is not exceeded for the relevant instruction.		Set the input parameter to the instruction so that the valid range of the input variable is not exceeded.	
Attached information	None					
Precautions/Remarks	None					

3 Error Descriptions and Corrections

Event name	Slave Coefficient Scaling Out of Range			Event code	54290000 hex	
Meaning	The parameter specified for the <i>SlaveScaling</i> input variable to a motion control instruction is out of range.					
Source	Motion Control Function Module		Source details	Axis	Detection timing	At instruction execution
Error attributes	Level	Minor fault	Recovery	Error reset	Log category	System
Effects	User program	Continues.	Operation	Operation is not possible for relevant slave axis. Relevant slave axis decelerates to a stop if it is in motion.		
System-defined variables	Variable		Data type		Name	
	_MC_AX[*].MFaultLvl.Active		BOOL		Axis Minor Fault Occurrence	
Cause and correction	Assumed cause		Correction		Prevention	
	Instruction input parameter exceeded the valid range of the input variable.		Correct the parameter so that the valid range of the input variable is not exceeded for the relevant instruction.		Set the input parameter to the instruction so that the valid range of the input variable is not exceeded.	
Attached information	None					
Precautions/Remarks	None					

Event name	Feeding Velocity Setting Out of Range			Event code	542A0000 hex	
Meaning	The parameter specified for the <i>FeedVelocity</i> input variable to a motion control instruction is out of range.					
Source	Motion Control Function Module		Source details	Axis	Detection timing	At instruction execution
Error attributes	Level	Minor fault	Recovery	Error reset	Log category	System
Effects	User program	Continues.	Operation	Operation is not possible for relevant axis. Relevant axis decelerates to a stop if it is in motion.		
System-defined variables	Variable		Data type		Name	
	_MC_AX[*].MFaultLvl.Active		BOOL		Axis Minor Fault Occurrence	
Cause and correction	Assumed cause		Correction		Prevention	
	The Feed Velocity (input variable <i>FeedVelocity</i>) is still at the default (0).		Specify a positive value for the Feed Velocity (input variable <i>FeedVelocity</i>).		Set the input parameter to the instruction so that the valid range of the input variable is not exceeded.	
Attached information	None					
Precautions/Remarks	None					

Event name	Buffer Mode Selection Out of Range		Event code	5420000 hex		
Meaning	The parameter specified for the <i>BufferMode</i> input variable to a motion control instruction is out of range.					
Source	Motion Control Function Module		Source details	Axis/axes group	Detection timing	At instruction execution
Error attributes	Level	Minor fault	Recovery	Error reset	Log category	System
Effects	User program	Continues.	Operation	If “axis” is given for the source details, operation is not possible for relevant axis. Relevant axis decelerates to a stop if it is in motion. If “axes group” is given for the source details, operation is not possible for relevant axes group. Relevant axes group decelerates to a stop if it is in motion.		
System-defined variables	Variable	Data type		Name		
	_MC_AX[*].MFAultLvl.Active	BOOL		Axis Minor Fault Occurrence		
	_MC_GRP[*].MFAultLvl.Active	BOOL		Axes Group Minor Fault Occurrence		
Cause and correction	Assumed cause		Correction		Prevention	
	Instruction input parameter exceeded the valid range of the input variable.		Correct the parameter so that the valid range of the input variable is not exceeded for the relevant instruction.		Set the input parameter to the instruction so that the valid range of the input variable is not exceeded.	
Attached information	None					
Precautions/Remarks	None					

Event name	Coordinate System Selection Out of Range		Event code	542C0000 hex		
Meaning	The parameter specified for the <i>CoordSystem</i> input variable to a motion control instruction is out of range.					
Source	Motion Control Function Module		Source details	Axes group	Detection timing	At instruction execution
Error attributes	Level	Minor fault	Recovery	Error reset	Log category	System
Effects	User program	Continues.	Operation	Operation is not possible for relevant axes group. Relevant axes group decelerates to a stop if it is in motion.		
System-defined variables	Variable	Data type		Name		
	_MC_GRP[*].MFAultLvl.Active	BOOL		Axes Group Minor Fault Occurrence		
Cause and correction	Assumed cause		Correction		Prevention	
	Instruction input parameter exceeded the valid range of the input variable.		Correct the parameter so that the valid range of the input variable is not exceeded for the relevant instruction.		Set the input parameter to the instruction so that the valid range of the input variable is not exceeded.	
Attached information	None					
Precautions/Remarks	None					

3 Error Descriptions and Corrections

Event name	Circular Interpolation Mode Selection Out of Range		Event code	542D0000 hex		
Meaning	The parameter specified for the <i>CircMode</i> input variable to a motion control instruction is out of range.					
Source	Motion Control Function Module		Source details	Axes group	Detection timing	At instruction execution
Error attributes	Level	Minor fault	Recovery	Error reset	Log category	System
Effects	User program	Continues.	Operation	Operation is not possible for relevant axes group. Relevant axes group decelerates to a stop if it is in motion.		
System-defined variables	Variable		Data type		Name	
	_MC_GRP[*].MFaultLvl.Active		BOOL		Axes Group Minor Fault Occurrence	
Cause and correction	Assumed cause		Correction		Prevention	
	Instruction input parameter exceeded the valid range of the input variable.		Correct the parameter so that the valid range of the input variable is not exceeded for the relevant instruction.		Set the input parameter to the instruction so that the valid range of the input variable is not exceeded.	
Attached information	None					
Precautions/Remarks	None					

Event name	Direction Selection Out of Range		Event code	542E0000 hex		
Meaning	The parameter specified for the <i>Direction</i> input variable to a motion control instruction is out of range.					
Source	Motion Control Function Module		Source details	Axis	Detection timing	At instruction execution
Error attributes	Level	Minor fault	Recovery	Error reset	Log category	System
Effects	User program	Continues.	Operation	Operation is not possible for relevant axis. Relevant axis decelerates to a stop if it is in motion.		
System-defined variables	Variable		Data type		Name	
	_MC_AX[*].MFaultLvl.Active		BOOL		Axis Minor Fault Occurrence	
Cause and correction	Assumed cause		Correction		Prevention	
	Instruction input parameter exceeded the valid range of the input variable.		Correct the parameter so that the valid range of the input variable is not exceeded for the relevant instruction.		Set the input parameter to the instruction so that the valid range of the input variable is not exceeded.	
Attached information	None					
Precautions/Remarks	None					

Event name	Path Selection Out of Range		Event code	542F0000 hex		
Meaning	The parameter specified for the <i>PathChoice</i> input variable to a motion control instruction is out of range.					
Source	Motion Control Function Module		Source details	Axes group	Detection timing	At instruction execution
Error attributes	Level	Minor fault	Recovery	Error reset	Log category	System
Effects	User program	Continues.	Operation	Operation is not possible for relevant axes group. Relevant axes group decelerates to a stop if it is in motion.		
System-defined variables	Variable		Data type		Name	
	_MC_GRP[*].MFAultLvl.Active		BOOL		Axes Group Minor Fault Occurrence	
Cause and correction	Assumed cause		Correction		Prevention	
	Instruction input parameter exceeded the valid range of the input variable.		Correct the parameter so that the valid range of the input variable is not exceeded for the relevant instruction.		Set the input parameter to the instruction so that the valid range of the input variable is not exceeded.	
Attached information	None					
Precautions/Remarks	None					

Event name	Position Type Selection Out of Range		Event code	54300000 hex		
Meaning	The parameter specified for the <i>ReferenceType</i> input variable to a motion control instruction is out of range.					
Source	Motion Control Function Module		Source details	MC common or axis	Detection timing	At instruction execution
Error attributes	Level	Minor fault	Recovery	Error reset	Log category	System
Effects	User program	Continues.	Operation	Operation is not possible for relevant axis. Relevant axis decelerates to a stop if it is in motion.		
System-defined variables	Variable		Data type		Name	
	_MC_COM.MFAultLvl.Active		BOOL		MC Common Minor Fault Occurrence	
	_MC_AX[*].MFAultLvl.Active		BOOL		Axis Minor Fault Occurrence	
Cause and correction	Assumed cause		Correction		Prevention	
	Instruction input parameter exceeded the valid range of the input variable.		Correct the parameter so that the valid range of the input variable is not exceeded for the relevant instruction.		Set the input parameter to the instruction so that the valid range of the input variable is not exceeded.	
Attached information	None					
Precautions/Remarks	None					

Event name	Travel Mode Selection Out of Range		Event code	54310000 hex	
Meaning	The parameter specified for the <i>MoveMode</i> input variable to a motion control instruction is out of range.				
Source	Motion Control Function Module		Source details	Axis/axes group	Detection timing At instruction execution
Error attributes	Level	Minor fault	Recovery	Error reset	Log category System
Effects	User program	Continues.	Operation	<p>If “axis” is given for the source details, operation is not possible for relevant axis. Relevant axis decelerates to a stop if it is in motion.</p> <p>If “axes group” is given for the source details, operation is not possible for relevant axes group. Relevant axes group decelerates to a stop if it is in motion.</p>	
System-defined variables	Variable		Data type	Name	
	_MC_AX[*].MFAultLvl.Active		BOOL	Axis Minor Fault Occurrence	
	_MC_GRP[*].MFAultLvl.Active		BOOL	Axes Group Minor Fault Occurrence	
Cause and correction	Assumed cause		Correction	Prevention	
	Instruction input parameter exceeded the valid range of the input variable.		Correct the parameter so that the valid range of the input variable is not exceeded for the relevant instruction.	Set the input parameter to the instruction so that the valid range of the input variable is not exceeded.	
Attached information	None				
Precautions/Remarks	None				

Event name	Transition Mode Selection Out of Range		Event code	54320000 hex		
Meaning	The parameter specified for the <i>TransitionMode</i> input variable to a motion control instruction is out of range.					
Source	Motion Control Function Module		Source details	Axes group	Detection timing	At instruction execution
Error attributes	Level	Minor fault	Recovery	Error reset	Log category	System
Effects	User program	Continues.	Operation	Operation is not possible for relevant axes group. Relevant axes group decelerates to a stop if it is in motion.		
System-defined variables	Variable	Data type		Name		
	_MC_GRP[*].MFAultLvl.Active	BOOL		Axes Group Minor Fault Occurrence		
Cause and correction	Assumed cause	Correction		Prevention		
	Instruction input parameter exceeded the valid range of the input variable.	Correct the parameter so that the valid range of the input variable is not exceeded for the relevant instruction.		Set the input parameter to the instruction so that the valid range of the input variable is not exceeded.		
	_mcAborting or _mcBuffered was specified for <i>BufferMode</i> and _mcTMCornerSuperimposed was specified for <i>TransitionMode</i> .	If you specify _mcAborting or _mcBuffered for <i>BufferMode</i> , specify _mcTMNone for <i>TransitionMode</i> . If you specify _mcTMCornerSuperimposed for <i>TransitionMode</i> , specify _mcBlendingLow, _mcBlendingPrevious, _mcBlendingNext, or _mcBlendingHigh for <i>BufferMode</i> .		If you specify _mcAborting or _mcBuffered for <i>BufferMode</i> , specify _mcTMNone for <i>TransitionMode</i> . If you specify _mcTMCornerSuperimposed for <i>TransitionMode</i> , specify _mcBlendingLow, _mcBlendingPrevious, _mcBlendingNext, or _mcBlendingHigh for <i>BufferMode</i> .		
Attached information	None					
Precautions/Remarks	None					

Event name	Continue Method Selection Out of Range		Event code	54330000 hex		
Meaning	The value of the reserved input variable <i>Continuous</i> to a motion control instruction changed.					
Source	Motion Control Function Module		Source details	Axis	Detection timing	At instruction execution
Error attributes	Level	Minor fault	Recovery	Error reset	Log category	System
Effects	User program	Continues.	Operation	Operation is not possible for relevant axis. Relevant axis decelerates to a stop if it is in motion.		
System-defined variables	Variable	Data type		Name		
	_MC_AX[*].MFAultLvl.Active	BOOL		Axis Minor Fault Occurrence		
Cause and correction	Assumed cause	Correction		Prevention		
	The value of the reserved input variable <i>Continuous</i> changed.	Correct the program so that the value of the reserved input variable <i>Continuous</i> does not change.		Write the user program so that the value of the reserved input variable <i>Continuous</i> does not change.		
Attached information	None					
Precautions/Remarks	None					

Event name	Combine Mode Selection Out of Range			Event code	54340000 hex	
Meaning	The parameter specified for the <i>CombineMode</i> input variable to a motion control instruction is out of range.					
Source	Motion Control Function Module		Source details	Axis	Detection timing	At instruction execution
Error attributes	Level	Minor fault	Recovery	Error reset	Log category	System
Effects	User program	Continues.	Operation	Operation is not possible for relevant axis. Relevant axis decelerates to a stop if it is in motion.		
System-defined variables	Variable		Data type		Name	
	_MC_AX[*].MFaultLvl.Active		BOOL		Axis Minor Fault Occurrence	
Cause and correction	Assumed cause		Correction		Prevention	
	Instruction input parameter exceeded the valid range of the input variable.		Correct the parameter so that the valid range of the input variable is not exceeded for the relevant instruction.		Set the input parameter to the instruction so that the valid range of the input variable is not exceeded.	
Attached information	None					
Precautions/Remarks	None					

Event name	Synchronization Start Condition Selection Out of Range			Event code	54350000 hex	
Meaning	The parameter specified for the <i>LinkOption</i> input variable to a motion control instruction is out of range.					
Source	Motion Control Function Module		Source details	Axis	Detection timing	At instruction execution
Error attributes	Level	Minor fault	Recovery	Error reset	Log category	System
Effects	User program	Continues.	Operation	Operation is not possible for relevant axis. Relevant axis decelerates to a stop if it is in motion.		
System-defined variables	Variable		Data type		Name	
	_MC_AX[*].MFaultLvl.Active		BOOL		Axis Minor Fault Occurrence	
Cause and correction	Assumed cause		Correction		Prevention	
	Instruction input parameter exceeded the valid range of the input variable.		Correct the parameter so that the valid range of the input variable is not exceeded for the relevant instruction.		Set the input parameter to the instruction so that the valid range of the input variable is not exceeded.	
Attached information	None					
Precautions/Remarks	None					

Event name	Master and Slave Defined as Same Axis		Event code	54360000 hex		
Meaning	The same axis is specified for the <i>Master</i> and <i>Slave</i> input variables to a motion control instruction.					
Source	Motion Control Function Module		Source details	MC common or axis	Detection timing	At instruction execution
Error attributes	Level	Minor fault	Recovery	Error reset	Log category	System
Effects	User program	Continues.	Operation	Operation is not possible for relevant slave axis. Relevant slave axis decelerates to a stop if it is in motion.		
System-defined variables	Variable	Data type		Name		
	_MC_COM.MFaultLvl.Active	BOOL		MC Common Minor Fault Occurrence		
	_MC_AX[*].MFaultLvl.Active	BOOL		Axis Minor Fault Occurrence		
Cause and correction	Assumed cause		Correction		Prevention	
	The parameter is the same for the <i>Master</i> and <i>Slave</i> input variables to the instruction.		Correct the parameters so that different axes are specified for the <i>Master</i> and <i>Slave</i> input variables to the instruction.		Specify different axes for the <i>Master</i> and <i>Slave</i> input variables to the instruction.	
Attached information	None					
Precautions/Remarks	None					

Event name	Master and Auxiliary Defined as Same Axis		Event code	54370000 hex		
Meaning	The same axis is specified for the <i>Master</i> and <i>Auxiliary</i> input variables to a motion control instruction.					
Source	Motion Control Function Module		Source details	Axis	Detection timing	At instruction execution
Error attributes	Level	Minor fault	Recovery	Error reset	Log category	System
Effects	User program	Continues.	Operation	Operation is not possible for relevant slave axis. Relevant slave axis decelerates to a stop if it is in motion.		
System-defined variables	Variable	Data type		Name		
	_MC_AX[*].MFaultLvl.Active	BOOL		Axis Minor Fault Occurrence		
Cause and correction	Assumed cause		Correction		Prevention	
	The parameter is the same for the <i>Master</i> and <i>Auxiliary</i> input variables to the instruction.		Correct the parameters so that different axes are specified for the <i>Master</i> and <i>Auxiliary</i> input variables to the instruction.		Specify different axes for the <i>Master</i> and <i>Auxiliary</i> input variables to the instruction.	
Attached information	None					
Precautions/Remarks	None					

3 Error Descriptions and Corrections

Event name	Master/Slave Axis Numbers Not in Ascending Order		Event code	54380000 hex		
Meaning	The axis numbers specified for the <i>Master</i> and <i>Slave</i> input variables to a motion control instruction are not in ascending order.					
Source	Motion Control Function Module		Source details	Axis	Detection timing	At instruction execution
Error attributes	Level	Minor fault	Recovery	Error reset	Log category	System
Effects	User program	Continues.	Operation	Operation is not possible for relevant slave axis. Relevant slave axis decelerates to a stop if it is in motion.		
System-defined variables	Variable		Data type		Name	
	_MC_AX[*].MFAultLvl.Active		BOOL		Axis Minor Fault Occurrence	
Cause and correction	Assumed cause		Correction		Prevention	
	The parameters for the <i>Master</i> and <i>Slave</i> input variables to the instruction were not in ascending order when <i>_mcLatestCommand</i> was specified for the <i>ReferenceType</i> input variable to the instruction.		When specifying <i>_mcLatestCommand</i> for the <i>ReferenceType</i> input variable to the instruction, correct the parameters so that the axis numbers specified for the <i>Master</i> and <i>Slave</i> input variables to the instruction are in ascending order. Or, specify <i>_mcCommand</i> for the Master Axis Position Type Selection.		When specifying <i>_mcLatestCommand</i> for the <i>ReferenceType</i> input variable, make sure to specify the master axis and slave axis input variables so that they are in ascending order.	
Attached information	None					
Precautions/Remarks	None					

Event name	Incorrect Cam Table Specification		Event code	54390000 hex		
Meaning	The parameter specified for the <i>CamTable</i> input variable to a motion control instruction is out of range.					
Source	Motion Control Function Module		Source details	MC common or axis	Detection timing	At instruction execution
Error attributes	Level	Minor fault	Recovery	Error reset	Log category	System
Effects	User program	Continues.	Operation	If "MC Common" is given for the source details, Not affected. If "axis" is given for the source details, operation is not possible for relevant slave axis.		
System-defined variables	Variable		Data type		Name	
	_MC_COM.MFAultLvl.Active		BOOL		MC Common Minor Fault Occurrence	
	_MC_AX[*].MFAultLvl.Active		BOOL		Axis Minor Fault Occurrence	
Cause and correction	Assumed cause		Correction		Prevention	
	Something other than a cam data variable was specified for the <i>CamTable</i> input variable to the instruction.		Correct the parameter specified for the <i>CamTable</i> input variable to the instruction so that it is a cam data variable.		Specify a cam data variable for the <i>CamTable</i> input variable to the instruction.	
Attached information	None					
Precautions/Remarks	None					

Event name	Synchronization Stopped		Event code	543A0000 hex	
Meaning	A synchronized control motion control instruction was executed, but conditions required for execution were not met.				
Source	Motion Control Function Module		Source details	Axis	Detection timing At instruction execution
Error attributes	Level	Minor fault	Recovery	Error reset	Log category System
Effects	User program	Continues.	Operation	Operation is not possible for relevant slave axis. Relevant slave axis decelerates to a stop if it is in motion.	
System-defined variables	Variable	Data type	Name		
	_MC_AX[*].MFaultLvl.Active	BOOL	Axis Minor Fault Occurrence		

Cause and correction	Assumed cause	Correction	Prevention
	<ul style="list-style-type: none"> • The MC_CamOut (End Cam Operation) instruction was executed even though the MC_CamIn (Start Cam Operation) or MC_CamInCurve (Start Cam Operation With Specified Curve) instruction is not being executed. • The MC_GearOut (End Gear Operation) instruction was executed even though the MC_GearIn (Start Gear Operation), MC_GearInPos (Positioning Gear Operation), or MC_GearInPos2 (Positioning Gear Operation2) instruction is not being executed. • The MC_Phasing (Shift Master Axis Phase) instruction was executed even though the MC_CamIn (Start Cam Operation), MC_CamInCurve (Start Cam Operation With Specified Curve), MC_GearIn (Start Gear Operation), MC_GearInPos (Positioning Gear Operation), MC_GearInPos2 (Positioning Gear Operation2), or MC_MoveLink (Synchronous Positioning) instruction is not being executed. <p>(NJ/NX-series)</p> <hr/> <ul style="list-style-type: none"> • The MC_CamOut (End Cam Operation) instruction was executed even though the MC_CamIn (Start Cam Operation) instruction is not being executed. • The MC_GearOut (End Gear Operation) instruction was executed even though the MC_GearIn (Start Gear Operation) or the MC_GearInPos (Positioning Gear Operation) instruction is not being executed. • The MC_Phasing (Shift Master Axis Phase) instruction was executed even though the MC_CamIn (Start Cam Operation), MC_GearIn (Start Gear Operation), MC_GearInPos (Start Gear Operation), or MC_MoveLink (Synchronous Positioning) instruction is not being executed. <p>(NY-series)</p>	<p>Correct the program so that required conditions are met when the instruction is executed.</p>	<p>Make sure that required conditions for execution are met when you execute synchronized control instructions.</p>

Attached information	None
Precautions/Remarks	None

Event name	Motion Control Instruction Re-execution Disabled		Event code	543B0000 hex	
Meaning	An attempt was made to re-execute a motion control instruction that cannot be re-executed.				
Source	Motion Control Function Module		Source details	MC common, axis, or axes group	Detection timing At instruction execution
Error attributes	Level	Minor fault	Recovery	Error reset	Log category System
Effects	User program	Continues.	Operation	<p>If “MC Common” is given for the source details, Not affected.</p> <p>If “axis” is given for the source details, operation is not possible for relevant axis. Relevant axis decelerates to a stop if it is in motion.</p> <p>If “axes group” is given for the source details, operation is not possible for relevant axes group. Relevant axes group decelerates to a stop if it is in motion.</p>	
System-defined variables	Variable	Data type		Name	
	_MC_COM.MFaultLvl.Active	BOOL		MC Common Minor Fault Occurrence	
	_MC_AX[*].MFaultLvl.Active	BOOL		Axis Minor Fault Occurrence	
	_MC_GRP[*].MFaultLvl.Active	BOOL		Axes Group Minor Fault Occurrence	
Cause and correction	Assumed cause	Correction		Prevention	
	A motion control instruction that cannot be re-executed was re-executed.	Correct the program so that the <i>Execute</i> input variable does not change to TRUE until the <i>Busy</i> output variable from the instruction changes to FALSE.		When using instructions that cannot be re-executed, include a condition for the <i>Execute</i> input variable so that it does not change to TRUE unless the <i>Busy</i> output variable for the previous instruction is FALSE. Or, stop the instruction before executing it again.	
Attached information	None				
Precautions/Remarks	None				

3 Error Descriptions and Corrections

Event name	Motion Control Instruction Multi-execution Disabled		Event code	543C0000 hex			
Meaning	Multiple functions that cannot be executed simultaneously were executed for the same target (MC common, axis, or axes group).						
Source	Motion Control Function Module		Source details	MC common, axis, or axes group	Detection timing	At multi-execution of instructions	
Error attributes	Level	Minor fault	Recovery	Error reset	Log category	System	
Effects	User program	Continues.	Operation	<p>If “MC Common” is given for the source details, Not affected.</p> <p>If “axis” is given for the source details, operation is not possible for relevant axis. Relevant axis decelerates to a stop if it is in motion.</p> <p>If “axes group” is given for the source details, operation is not possible for relevant axes group. Relevant axes group decelerates to a stop if it is in motion.</p>			
System-defined variables	Variable		Data type		Name		
	_MC_COM.MFaultLvl.Active		BOOL		MC Common Minor Fault Occurrence		
	_MC_AX[*].MFaultLvl.Active		BOOL		Axis Minor Fault Occurrence		
		_MC_GRP[*].MFaultLvl.Active		BOOL		Axes Group Minor Fault Occurrence	
Cause and correction	Assumed cause		Correction		Prevention		
	Multiple functions that cannot be executed simultaneously were executed for the same target (MC common, axis, or axes group).		Check the specifications of multi-execution of instructions for this instruction and correct the program so that instructions that cannot be executed at the same time are not executed simultaneously.		Check the specifications for multi-execution of instructions for the instruction and do not execute instructions that cannot be executed at the same time.		
Attached information	None						
Precautions/Remarks	None						

Event name	Instruction Not Allowed for Encoder Axis Type		Event code	543D0000 hex		
Meaning	An operation instruction was executed for an encoder axis.					
Source	Motion Control Function Module		Source details	Axis	Detection timing	At instruction execution
Error attributes	Level	Minor fault	Recovery	Error reset	Log category	System
Effects	User program	Continues.	Operation	Operation is not possible for relevant axis.		
System-defined variables	Variable		Data type		Name	
	_MC_AX[*].MFaultLvl.Active		BOOL		Axis Minor Fault Occurrence	
Cause and correction	Assumed cause		Correction		Prevention	
	An operation instruction was executed for an encoder axis.		Specify either a Servo axis or virtual Servo axis as the axis type for the instruction, or correct the program so that the instruction is not executed for an encoder axis.		Only execute motion instructions for Servo axes or virtual Servo axes.	
Attached information	None					
Precautions/Remarks	None					

Event name	Instruction Cannot Be Executed during Multi-axes Co-ordinated Control		Event code	543E0000 hex		
Meaning	<ul style="list-style-type: none"> An operation instruction was executed for an axis or an axes group that was in a coordinated multi-axes motion. A robot instruction that you cannot use for an axes group in a GroupEnable state was executed. 					
Source	Motion Control Function Module		Source details	Axis or axis group	Detection timing	At multi-execution of instructions
Error attributes	Level	Minor fault	Recovery	Error reset	Log category	System
Effects	User program	Continues.	Operation	The axes group decelerates to a stop.		
System-defined variables	Variable		Data type		Name	
	_MC_AX[*].MFAultLvl.Active		BOOL		Axis Minor Fault Occurrence	
	_MC_GRP[*].MFAultLvl.Active		BOOL		Axes Group Minor Fault Occurrence	
Cause and correction	Assumed cause		Correction		Prevention	
	An operation instruction was executed for an axis or an axes group that was in a coordinated multi-axes motion.		Correct the program so that axis operation instructions are executed only for axes or axes groups that are not in coordinated multi-axes motion.		Execute axis operation instructions only for axes or axes groups that are not in coordinated multi-axes motion.	
	The MC_SetKinTransform (Set Kinematics Transformation) instruction was executed for an axes group in a GroupEnable state.		Correct the program so that the instruction is executed only when the axes group is in a GroupDisable state.		Execute the instruction only when the axes group is in a GroupDisable state.	
Attached information	None					
Precautions/Remarks	None					

Event name	Multi-axes Coordinated Control Instruction Executed for Disabled Axes Group		Event code	543F0000 hex		
Meaning	A multi-axes coordinated control instruction was executed for an axes group that was in the Axes Group Disabled state.					
Source	Motion Control Function Module		Source details	Axes group	Detection timing	At instruction execution
Error attributes	Level	Minor fault	Recovery	Error reset	Log category	System
Effects	User program	Continues.	Operation	Operation is not possible for relevant axes group. Relevant axes group decelerates to a stop if it is in motion.		
System-defined variables	Variable	Data type		Name		
	_MC_GRP[*].MFAultLvl.Active	BOOL		Axes Group Minor Fault Occurrence		
Cause and correction	Assumed cause	Correction		Prevention		
	A multi-axes coordinated control instruction was executed for an axes group that was in the Axes Group Disabled state.	Correct the program so that the instruction is executed only after changing the axes group to the Axes Group Enabled state. Execute the MC_GroupEnable (Enable Axes Group) instruction to change an axes group to the Axes Group Enabled state.		Execute multi-axes coordinated operation instructions only after enabling the axes group. Execute the MC_GroupEnable (Enable Axes Group) instruction to change an axes group to the Axes Group Enabled state.		
	One of the following instructions was executed for an axes group that was in a GroupDisable state. <ul style="list-style-type: none"> • MC_MoveTimeAbsolute (Time-specified Absolute Positioning) instruction • MC_SyncLinearConveyor (Start Conveyor Synchronization) instruction • MC_SyncOut (End Synchronization) instruction • MC_RobotJog (Axes Group Jog) instruction 					
Attached information	None					
Precautions/Remarks	None					

Event name	Axes Group Cannot Be Enabled		Event code	54400000 hex	
Meaning	Execution of the MC_GroupEnable (Enable Axes Group) instruction failed.				
Source	Motion Control Function Module		Source details	Axes group	Detection timing At instruction execution
Error attributes	Level	Minor fault	Recovery	Error reset	Log category System
Effects	User program	Continues.	Operation	Operation is not possible for relevant axes group. The operation of the composition axes will continue.	
System-defined variables	Variable	Data type		Name	
	_MC_GRP[*].MFAultLvl.Active	BOOL		Axes Group Minor Fault Occurrence	
Cause and correction	Assumed cause	Correction		Prevention	
	When the MC_GroupEnable (Enable Axes Group) instruction was executed, there was a composition axis that was not stopped.	Correct the program so that the MC_GroupEnable (Enable Axes Group) instruction is executed only when all composition axes are stopped. An axis is stopped if <i>Status.Disabled</i> or <i>Status.Standstill</i> is TRUE in the Axis Variable.		Write the programs so that the MC_GroupEnable (Enable Axes Group) instruction is executed only when all composition axes are stopped. An axis is stopped if <i>Status.Disabled</i> or <i>Status.Standstill</i> is TRUE in the Axis Variable.	
	When the MC_GroupEnable (Enable Axes Group) instruction was executed, there was a composition axis for which the MC_TouchProbe (Enable External Latch) instruction was being executed.	Correct the program so that the MC_GroupEnable (Enable Axes Group) instruction is executed only when the MC_TouchProbe (Enable External Latch) instruction is not being executed for any of the composition axes.		Write the program so that the MC_GroupEnable (Enable Axes Group) instruction is executed only when the MC_TouchProbe (Enable External Latch) instruction is not being executed for any of the composition axes.	
Attached information	None				
Precautions/Remarks	None				

Event name	Impossible Axis Operation Specified when the Servo is OFF		Event code	54410000 hex		
Meaning	An operation instruction was executed for an axis for which the Servo is OFF.					
Source	Motion Control Function Module		Source details	Axis/axes group	Detection timing	At instruction execution
Error attributes	Level	Minor fault	Recovery	Error reset	Log category	System
Effects	User program	Continues.	Operation	The motion instruction will not start.		
System-defined variables	Variable		Data type		Name	
	_MC_AX[*].MFAultLvl.Active		BOOL		Axis Minor Fault Occurrence	
	_MC_GRP[*].MFAultLvl.Active		BOOL		Axes Group Minor Fault Occurrence	
Cause and correction	Assumed cause		Correction		Prevention	
	An operation instruction was executed for an axis for which the Servo is OFF.		Correct the program so that the instruction is executed after the Servo is turned ON.		Make sure to execute the axis operation instruction after the Servo is turned ON.	
Home was preset with the MC_Home or MC_HomeWithParameter instruction for an axis for which EtherCAT process data communications are not established.		If the <i>_EC_PDSlavTbl</i> (Process Data Communicating Slave Table) system-defined variable for the EtherCAT master of the master axis is FALSE, remove the cause and execute the MC_Home or MC_HomeWithParameter instruction to preset home after <i>_EC_PDSlavTbl</i> changes to TRUE.		If you execute the MC_Home or MC_HomeWithParameter instruction to preset home immediately after you turn ON the power supply to the Controller, download data, reset a slave communications error, disconnect the slave, reconnect the slave, enable the slave, or disable the slave, write the program to make sure that the <i>_EC_PDSlavTbl</i> (Process Data Communicating Slave Table) system-defined variable for the EtherCAT master is TRUE before you execute MC_Home or MC_HomeWithParameter.		
Attached information	Attached Information 1: Depends on the source details <ul style="list-style-type: none"> • Axis: 0 • Axes group: Number of the logical axis where the error occurred 					
Precautions/Remarks	None					

Event name	Composition Axis Stopped Error		Event code	54420000 hex		
Meaning	A motion instruction was executed for an axes group while the MC_Stop instruction was being executed for a composition axis.					
Source	Motion Control Function Module		Source details	Axes group	Detection timing	At instruction execution
Error attributes	Level	Minor fault	Recovery	Error reset	Log category	System
Effects	User program	Continues.	Operation	Operation is not possible for relevant axes group.		
System-defined variables	Variable		Data type		Name	
	_MC_GRP[*].MFAultLvl.Active		BOOL		Axes Group Minor Fault Occurrence	
Cause and correction	Assumed cause		Correction		Prevention	
	A motion instruction was executed for an axes group while the MC_Stop instruction was being executed for a composition axis.		Change the <i>Execute</i> input variable to the MC_Stop instruction for the composition axis to FALSE, reset the error, and then execute the motion control instruction.		Change the <i>Execute</i> input variables to the MC_Stop instructions for all of the composition axes to FALSE before you execute motion control instruction.	
Attached information	Attached information 1: Number of the logical axis that was stopped.					
Precautions/Remarks	None					

Event name	Motion Control Instruction Multi-execution Buffer Limit Exceeded		Event code	54430000 hex		
Meaning	The number of motion control instructions that is buffered for Buffered or Blending Buffer Modes exceeded the buffer limit.					
Source	Motion Control Function Module		Source details	Axis/axes group	Detection timing	At multi-execution of instructions
Error attributes	Level	Minor fault	Recovery	Error reset	Log category	System
Effects	User program	Continues.	Operation	If "axis" is given for the source details, operation is not possible for relevant axis. Relevant axis decelerates to a stop if it is in motion. If "axes group" is given for the source details, operation is not possible for relevant axes group. Relevant axes group decelerates to a stop if it is in motion.		
System-defined variables	Variable		Data type		Name	
	_MC_AX[*].MFAultLvl.Active		BOOL		Axis Minor Fault Occurrence	
	_MC_GRP[*].MFAultLvl.Active		BOOL		Axes Group Minor Fault Occurrence	
Cause and correction	Assumed cause		Correction		Prevention	
	An axis instruction was executed when there was already a current instruction and a buffered instruction for the same axis.		Correct the program so that the number of executed instructions does not exceed the buffer limit.		Do not execute an axis instruction when there is already a current instruction and a buffered instruction for the same axis.	
An axes group instruction was executed when there was already eight current instructions and buffered instructions for the same axis.		Do not execute an axes group instruction when there are already eight current and buffered instructions for the same axis.				
Attached information	None					
Precautions/Remarks	None					

Event name	Insufficient Travel Distance		Event code	54440000 hex		
Meaning	The specified motion cannot be executed for the deceleration rate or acceleration rate that was specified for multi-execution or re-execution of a positioning instruction.					
Source	Motion Control Function Module		Source details	Axis/axes group	Detection timing	At instruction execution
Error attributes	Level	Minor fault	Recovery	Error reset	Log category	System
Effects	User program	Continues.	Operation	<p>If “axis” is given for the source details, operation is not possible for relevant axis. Relevant axis decelerates to a stop if it is in motion.</p> <p>If “axes group” is given for the source details, operation is not possible for relevant axes group. Relevant axes group decelerates to a stop if it is in motion.</p>		
System-defined variables	Variable	Data type		Name		
	_MC_AX[*].MFAultLvl.Active	BOOL		Axis Minor Fault Occurrence		
	_MC_GRP[*].MFAultLvl.Active	BOOL		Axes Group Minor Fault Occurrence		
Cause and correction	Assumed cause		Correction		Prevention	
	<p>Stopping at the target position was not possible for the specified acceleration/deceleration rate for multi-execution or re-execution of a positioning instruction when the Acceleration/Deceleration Over parameter was set to generate a minor fault and stop.</p>		<p>Correct the program based on the operating specifications for the instruction so that the target position is not exceeded at the deceleration rate or acceleration rate specified for multi-execution or re-execution of the positioning instruction.</p> <p>Or, change the Acceleration/Deceleration Over parameter to a setting other than to generate a minor fault and stop.</p>		<p>Check the operating specifications for the relevant instruction and write the program so that this error does not occur.</p> <p>Or, change the Acceleration/Deceleration Over parameter to a setting other than to generate a minor fault and stop.</p>	
Attached information	None					
Precautions/Remarks	None					

Event name	Insufficient Travel Distance to Achieve Blending Transit Velocity		Event code	54450000 hex		
Meaning	There is not sufficient travel distance to accelerate or decelerate to the transit velocity.					
Source	Motion Control Function Module		Source details	Axis/axes group	Detection timing	At multi-execution of instructions
Error attributes	Level	Minor fault	Recovery	Error reset	Log category	System
Effects	User program	Continues.	Operation	If "axis" is given for the source details, operation is not possible for relevant axis. Relevant axis decelerates to a stop if it is in motion. If "axes group" is given for the source details, operation is not possible for relevant axes group. Relevant axes group decelerates to a stop if it is in motion.		
System-defined variables	Variable		Data type		Name	
	_MC_AX[*].MFAultLvl.Active		BOOL		Axis Minor Fault Occurrence	
		_MC_GRP[*].MFAultLvl.Active		BOOL		Axes Group Minor Fault Occurrence
Cause and correction	Assumed cause		Correction		Prevention	
	There was not sufficient travel distance to accelerate the current command to the transit velocity when the Acceleration/Deceleration Over parameter was set to generate a minor fault and stop.		Correct the program to allow a sufficient travel distance according to the operating specifications of the instruction. Or, change the Acceleration/Deceleration Over parameter to a setting other than to generate a minor fault and stop.		Check the operating specifications for the relevant instruction and write the program so that this error does not occur. Or, change the Acceleration/Deceleration Over parameter to a setting other than to generate a minor fault and stop.	
Attached information	None					
Precautions/Remarks	None					

Event name	Move Link Constant Velocity Insufficient Travel Distance		Event code	54460000 hex		
Meaning	The constant-velocity travel distance of the master axis is less than zero.					
Source	Motion Control Function Module		Source details	Axis	Detection timing	At instruction execution
Error attributes	Level	Minor fault	Recovery	Error reset	Log category	System
Effects	User program	Continues.	Operation	Operation is not possible for relevant axis. Relevant axis decelerates to a stop if it is in motion.		
System-defined variables	Variable		Data type		Name	
	_MC_AX[*].MFAultLvl.Active		BOOL		Axis Minor Fault Occurrence	
Cause and correction	Assumed cause		Correction		Prevention	
	The constant velocity travel distance of the master axis is below 0 for the MC_MoveLink (Synchronous Positioning) instruction.		Correct the program so that the master axis travel distance is greater than or equal to the master distance in acceleration plus the master distance in deceleration.		Check the operating specifications for the relevant instruction and write the program so that this error does not occur.	
Attached information	None					
Precautions/Remarks	None					

Event name	Positioning Gear Operation Insufficient Target Velocity		Event code	54470000 hex		
Meaning	For the MC_GearInPos (Positioning Gear Operation) or MC_GearInPos2 (Positioning Gear Operation2) instruction, the target velocity of the slave axis is too small to achieve the required velocity. (NJ/NX-series) For the MC_GearInPos (Positioning Gear Operation) instruction, the target velocity of the slave axis is too small to achieve the required velocity. (NY-series)					
Source	Motion Control Function Module		Source details	Axis	Detection timing	At instruction execution or during instruction execution
Error attributes	Level	Minor fault	Recovery	Error reset	Log category	System
Effects	User program	Continues.	Operation	Operation is not possible for relevant axis. Relevant axis decelerates to a stop if it is in motion.		
System-defined variables	Variable	Data type		Name		
	_MC_AX[*].MFAultLvl.Active	BOOL		Axis Minor Fault Occurrence		
Cause and correction	Assumed cause		Correction		Prevention	
	For the MC_GearInPos (Positioning Gear Operation) or MC_GearInPos2 (Positioning Gear Operation2) instruction, the value of the <i>Velocity (Target Velocity)</i> input variable is smaller than the master axis velocity multiplied by the gear ratio when the instruction was executed. (NJ/NX-series)		Set the value of the <i>Velocity (Target Velocity)</i> input variable to a value that is greater than the master axis velocity multiplied by the gear ratio when the instruction is executed based on the operating specifications of the instruction.		Check the operating specifications for the relevant instruction and write the program so that this error does not occur.	
	For the MC_GearInPos (Positioning Gear Operation) instruction, the value of the <i>Velocity (Target Velocity)</i> input variable is smaller than the master axis velocity multiplied by the gear ratio when the instruction was executed. (NY-series)					
Attached information	None					
Precautions/Remarks	None					

Event name	Same Start Point and End Point for Circular Interpolation		Event code	54480000 hex		
Meaning	The start point and end point were the same when the radius method was specified for the MC_MoveCircular2D (Circular 2D Interpolation) instruction. Or, the start point, end point, and border point were the same when the border point method was specified.					
Source	Motion Control Function Module		Source details	Axes group	Detection timing	At instruction execution
Error attributes	Level	Minor fault	Recovery	Error reset	Log category	System
Effects	User program	Continues.	Operation	Operation is not possible for relevant axes group. Relevant axes group decelerates to a stop if it is in motion.		
System-defined variables	Variable	Data type		Name		
	_MC_GRP[*].MFAultLvl.Active	BOOL		Axes Group Minor Fault Occurrence		
Cause and correction	Assumed cause	Correction		Prevention		
	The start point and end point were the same when the radius method was specified for the MC_MoveCircular2D (Circular 2D Interpolation) instruction.	Correct the program so that the radius specification is not used when the start point and end point for the instruction are the same.		Do not use the same start point and end point when you execute circular interpolation with a radius specification.		
	The start point, end point, and border point were the same when the border point method was specified for the MC_MoveCircular2D (Circular 2D Interpolation) instruction.	Correct the program so that border point specification is not used when the start point, end point, and border point for the instruction are the same.		Do not use the same start point, end point, and border point when you execute circular interpolation with a border point specification.		
Attached information	None					
Precautions/Remarks	None					

Event name	Circular Interpolation Center Specification Position Out of Range		Event code	54490000 hex		
Meaning	The position specified for the center point exceeded the allowed range when the center method was specified for the MC_MoveCircular2D (Circular 2D Interpolation) instruction.					
Source	Motion Control Function Module		Source details	Axes group	Detection timing	At instruction execution
Error attributes	Level	Minor fault	Recovery	Error reset	Log category	System
Effects	User program	Continues.	Operation	Operation is not possible for relevant axes group. Relevant axes group decelerates to a stop if it is in motion.		
System-defined variables	Variable	Data type		Name		
	_MC_GRP[*].MFAultLvl.Active	BOOL		Axes Group Minor Fault Occurrence		
Cause and correction	Assumed cause	Correction		Prevention		
	The difference between the distance from the start point to the center point and the distance between the end point to the center point exceeded the permitted value specified for the correction allowance ratio in the axes group settings when the center designation method was specified for the MC_MoveCircular2D (Circular 2D Interpolation) instruction.	Correct the center point so that the difference between the distance from the start point to the center point input variables and the distance between the end point to the center point input variables is less than the permitted value specified for the correction allowance ratio in the axes group settings.		Correct the difference between the distance from the start point to the center point and the distance between the end point to the center point so that it does not exceed the correction allowance ratio in the axes group settings.		
Attached information	None					
Precautions/Remarks	None					

Event name	Instruction Execution Error Caused by Count Mode Setting		Event code	544A0000 hex		
Meaning	An instruction that cannot be used when the Count Mode is set to Rotary Mode was executed for an axis that was set to Rotary Mode.					
Source	Motion Control Function Module		Source details	Axes group	Detection timing	At instruction execution
Error attributes	Level	Minor fault	Recovery	Error reset	Log category	System
Effects	User program	Continues.	Operation	Operation is not possible for relevant axes group. Relevant axes group decelerates to a stop if it is in motion.		
System-defined variables	Variable	Data type		Name		
	_MC_GRP[*].MFAultLvl.Active	BOOL		Axes Group Minor Fault Occurrence		
Cause and correction	Assumed cause	Correction		Prevention		
	An instruction that cannot be used when the Count Mode is set to Rotary Mode was executed for an axis that was set to Rotary Mode.	Change the Count Mode of the relevant axis to Linear Mode.		Confirm the Count Mode in which you can execute the instruction and set the correct Count Mode for the axis.		
Attached information	None					
Precautions/Remarks	None					

Event name	Parameter Selection Out of Range			Event code	544C0000 hex	
Meaning	The parameter specified for the <i>ParameterNumber</i> input variable to a motion control instruction is out of range.					
Source	Motion Control Function Module		Source details	MC Common	Detection timing	At instruction execution
Error attributes	Level	Minor fault	Recovery	Error reset	Log category	System
Effects	User program	Continues.	Operation	The instruction is not executed.		
System-defined variables	Variable		Data type		Name	
	_MC_COM.MFaultLvl.Active		BOOL		MC Common Minor Fault Occurrence	
Cause and correction	Assumed cause		Correction		Prevention	
	Instruction input parameter exceeded the valid range of the input variable.		Correct the parameter so that the valid range of the input variable is not exceeded for the relevant instruction.		Set the input parameter to the instruction so that the valid range of the input variable is not exceeded.	
Attached information	None					
Precautions/Remarks	None					

Event name	Stop Method Selection Out of Range			Event code	544D0000 hex	
Meaning	The parameter specified for the <i>StopMode</i> input variable to a motion control instruction is out of range.					
Source	Motion Control Function Module		Source details	Axis	Detection timing	At instruction execution
Error attributes	Level	Minor fault	Recovery	Error reset	Log category	System
Effects	User program	Continues.	Operation	Operation is not possible for relevant axis. Relevant axis decelerates to a stop if it is in motion.		
System-defined variables	Variable		Data type		Name	
	_MC_AX[*].MFaultLvl.Active		BOOL		Axis Minor Fault Occurrence	
Cause and correction	Assumed cause		Correction		Prevention	
	Instruction input parameter exceeded the valid range of the input variable.		Correct the parameter so that the valid range of the input variable is not exceeded for the relevant instruction.		Set the input parameter to the instruction so that the valid range of the input variable is not exceeded.	
Attached information	None					
Precautions/Remarks	None					

3 Error Descriptions and Corrections

Event name	Latch ID Selection Out of Range for Trigger Input Condition		Event code	544E0000 hex		
Meaning	The parameter specified for the <i>TriggerInput::LatchID</i> input variable to a motion control instruction is out of range.					
Source	Motion Control Function Module		Source details	Axis	Detection timing	At instruction execution
Error attributes	Level	Minor fault	Recovery	Error reset	Log category	System
Effects	User program	Continues.	Operation	Operation is not possible for relevant axis. Relevant axis decelerates to a stop if it is in motion.		
System-defined variables	Variable		Data type		Name	
	_MC_AX[*].MFAultLvl.Active		BOOL		Axis Minor Fault Occurrence	
Cause and correction	Assumed cause		Correction		Prevention	
	Instruction input parameter exceeded the valid range of the input variable.		Correct the parameter so that the valid range of the input variable is not exceeded for the relevant instruction.		Set the input parameter to the instruction so that the valid range of the input variable is not exceeded.	
Attached information	None					
Precautions/Remarks	None					

Event name	Setting Out of Range for Writing MC Setting		Event code	544F0000 hex		
Meaning	The parameter specified for the <i>SettingValue</i> input variable to a motion control instruction is out of range.					
Source	Motion Control Function Module		Source details	MC Common	Detection timing	At instruction execution
Error attributes	Level	Minor fault	Recovery	Error reset	Log category	System
Effects	User program	Continues.	Operation	The instruction is not executed.		
System-defined variables	Variable		Data type		Name	
	_MC_COM.MFAultLvl.Active		BOOL		MC Common Minor Fault Occurrence	
Cause and correction	Assumed cause		Correction		Prevention	
	Instruction input parameter exceeded the valid range of the input variable.		Correct the parameter so that the valid range of the input variable is not exceeded for the relevant instruction.		Set the input parameter to the instruction so that the valid range of the input variable is not exceeded.	
	The parameter specification and the data type of the setting value do not agree.		Make corrections so that the parameter settings and the data types of the settings agree.		Make sure the parameter settings and the data type of the setting values agree.	
Attached information	None					
Precautions/Remarks	None					

Event name	Trigger Input Condition Mode Selection Out of Range		Event code	54500000 hex		
Meaning	The parameter specified for the <i>TriggerInput::Mode</i> input variable to a motion control instruction is out of range.					
Source	Motion Control Function Module		Source details	Axis	Detection timing	At instruction execution
Error attributes	Level	Minor fault	Recovery	Error reset	Log category	System
Effects	User program	Continues.	Operation	Operation is not possible for relevant axis. Relevant axis decelerates to a stop if it is in motion.		
System-defined variables	Variable		Data type		Name	
	_MC_AX[*].MFAultLvl.Active		BOOL		Axis Minor Fault Occurrence	
Cause and correction	Assumed cause		Correction		Prevention	
	Instruction input parameter exceeded the valid range of the input variable.		Correct the parameter so that the valid range of the input variable is not exceeded for the relevant instruction.		Set the input parameter to the instruction so that the valid range of the input variable is not exceeded.	
Attached information	None					
Precautions/Remarks	None					

Event name	Drive Trigger Signal Selection Out of Range for Trigger Input Condition		Event code	54510000 hex		
Meaning	The parameter specified for the <i>TriggerInput::InputDrive</i> input variable to a motion control instruction is out of range.					
Source	Motion Control Function Module		Source details	Axis	Detection timing	At instruction execution
Error attributes	Level	Minor fault	Recovery	Error reset	Log category	System
Effects	User program	Continues.	Operation	Operation is not possible for relevant axis. Relevant axis decelerates to a stop if it is in motion.		
System-defined variables	Variable		Data type		Name	
	_MC_AX[*].MFAultLvl.Active		BOOL		Axis Minor Fault Occurrence	
Cause and correction	Assumed cause		Correction		Prevention	
	Instruction input parameter exceeded the valid range of the input variable.		Correct the parameter so that the valid range of the input variable is not exceeded for the relevant instruction.		Set the input parameter to the instruction so that the valid range of the input variable is not exceeded.	
Attached information	None					
Precautions/Remarks	None					

Event name	Motion Control Instruction Re-execution Disabled (Axis Specification)		Event code	54530000 hex		
Meaning	An attempt was made to change the parameter for the Axis input variable when re-executing a motion control instruction. (This input variable cannot be changed when re-executing an instruction.)					
Source	Motion Control Function Module		Source details	Axis	Detection timing	At instruction re-execution
Error attributes	Level	Minor fault	Recovery	Error reset	Log category	System
Effects	User program	Continues.	Operation	Operation is not possible for relevant axis. Relevant axis decelerates to a stop if it is in motion.		
System-defined variables	Variable		Data type		Name	
	_MC_AX[*].MFAultLvl.Active		BOOL		Axis Minor Fault Occurrence	
Cause and correction	Assumed cause		Correction		Prevention	
	A parameter for an input variable that cannot be changed for re-execution was changed.		Correct the program so that the parameter for the relevant input variable does not change when the relevant instruction is re-executed.		Check the manual to see if the input variables to the relevant motion control instruction can be changed by re-execution. Write the program so that the input parameters for any input variable that cannot be changed do not change upon re-execution.	
Attached information	None					
Precautions/Remarks	None					

Event name	Motion Control Instruction Re-execution Disabled (Buffer Mode Selection)		Event code	54540000 hex		
Meaning	An attempt was made to change the parameter for the <i>BufferMode</i> input variable when re-executing a motion control instruction. (This input variable cannot be changed when re-executing an instruction.)					
Source	Motion Control Function Module		Source details	Axis/axes group	Detection timing	At instruction re-execution
Error attributes	Level	Minor fault	Recovery	Error reset	Log category	System
Effects	User program	Continues.	Operation	If "axis" is given for the source details, operation is not possible for relevant axis. Relevant axis decelerates to a stop if it is in motion. If "axes group" is given for the source details, operation is not possible for relevant axes group. Relevant axes group decelerates to a stop if it is in motion.		
System-defined variables	Variable	Data type		Name		
	_MC_AX[*].MFAultLvl.Active	BOOL		Axis Minor Fault Occurrence		
	_MC_GRP[*].MFAultLvl.Active	BOOL		Axes Group Minor Fault Occurrence		
Cause and correction	Assumed cause		Correction		Prevention	
	A parameter for an input variable that cannot be changed for re-execution was changed.		Correct the program so that the parameter for the relevant input variable does not change when the relevant instruction is re-executed.		Check the manual to see if the input variables to the relevant motion control instruction can be changed by re-execution. Write the program so that the input parameters for any input variable that cannot be changed do not change upon re-execution.	
Attached information	None					
Precautions/Remarks	None					

Event name	Motion Control Instruction Re-execution Disabled (Direction Selection)		Event code	54550000 hex		
Meaning	An attempt was made to change the parameter for the <i>Direction</i> input variable when re-executing a motion control instruction. (This input variable cannot be changed when re-executing an instruction.)					
Source	Motion Control Function Module		Source details	Axis	Detection timing	At instruction re-execution
Error attributes	Level	Minor fault	Recovery	Error reset	Log category	System
Effects	User program	Continues.	Operation	Operation is not possible for relevant axis. Relevant axis decelerates to a stop if it is in motion.		
System-defined variables	Variable		Data type		Name	
	_MC_AX[*].MFAultLvl.Active		BOOL		Axis Minor Fault Occurrence	
Cause and correction	Assumed cause		Correction		Prevention	
	An input variable that cannot be changed for re-execution was changed.		Correct the program so that the parameter for the relevant input variable does not change when the relevant instruction is re-executed.		Check the manual to see if the input variables to the relevant motion control instruction can be changed by re-execution. Write the program so that the input parameters for any input variable that cannot be changed do not change upon re-execution.	
Attached information	None					
Precautions/Remarks	None					

Event name	Motion Control Instruction Re-execution Disabled (Execution Mode)		Event code	54560000 hex		
Meaning	An attempt was made to change the parameter for the <i>Periodic</i> input variable when re-executing a motion control instruction. (This input variable cannot be changed when re-executing an instruction.)					
Source	Motion Control Function Module		Source details	Axis	Detection timing	At instruction re-execution
Error attributes	Level	Minor fault	Recovery	Error reset	Log category	System
Effects	User program	Continues.	Operation	Operation is not possible for relevant axis. Relevant axis decelerates to a stop if it is in motion.		
System-defined variables	Variable		Data type		Name	
	_MC_AX[*].MFAultLvl.Active		BOOL		Axis Minor Fault Occurrence	
Cause and correction	Assumed cause		Correction		Prevention	
	A parameter for an input variable that cannot be changed for re-execution was changed.		Correct the program so that the parameter for the relevant input variable does not change when the relevant instruction is re-executed.		Check the manual to see if the input variables to the relevant motion control instruction can be changed by re-execution. Write the program so that the input parameters for any input variable that cannot be changed do not change upon re-execution.	
Attached information	None					
Precautions/Remarks	None					

Event name	Motion Control Instruction Re-execution Disabled (Axes Group Specification)		Event code	54570000 hex		
Meaning	An attempt was made to change the parameter for the <i>AxesGroup</i> input variable when re-executing a motion control instruction. (This input variable cannot be changed when re-executing an instruction.)					
Source	Motion Control Function Module		Source details	Axes group	Detection timing	At instruction re-execution
Error attributes	Level	Minor fault	Recovery	Error reset	Log category	System
Effects	User program	Continues.	Operation	Operation is not possible for relevant axes group. Relevant axes group decelerates to a stop if it is in motion.		
System-defined variables	Variable	Data type		Name		
	_MC_GRP[*].MFAultLvl.Active	BOOL		Axes Group Minor Fault Occurrence		
Cause and correction	Assumed cause		Correction		Prevention	
	A parameter for an input variable that cannot be changed for re-execution was changed.		Correct the program so that the parameter for the relevant input variable does not change when the relevant instruction is re-executed.		Check the manual to see if the input variables to the relevant motion control instruction can be changed by re-execution. Write the program so that the input parameters for any input variable that cannot be changed do not change upon re-execution.	
Attached information	None					
Precautions/Remarks	None					

Event name	Motion Control Instruction Re-execution Disabled (Jerk Setting)		Event code	54580000 hex		
Meaning	An attempt was made to change the parameter for the <i>Jerk</i> input variable when re-executing a motion control instruction. (This input variable cannot be changed when re-executing an instruction.)					
Source	Motion Control Function Module		Source details	Axis/axes group	Detection timing	At instruction re-execution
Error attributes	Level	Minor fault	Recovery	Error reset	Log category	System
Effects	User program	Continues.	Operation	<p>If “axis” is given for the source details, operation is not possible for relevant axis. Relevant axis decelerates to a stop if it is in motion.</p> <p>If “axes group” is given for the source details, operation is not possible for relevant axes group. Relevant axes group decelerates to a stop if it is in motion.</p>		
System-defined variables	Variable	Data type		Name		
	_MC_AX[*].MFAultLvl.Active	BOOL		Axis Minor Fault Occurrence		
	_MC_GRP[*].MFAultLvl.Active	BOOL		Axes Group Minor Fault Occurrence		
Cause and correction	Assumed cause		Correction		Prevention	
	A parameter for an input variable that cannot be changed for re-execution was changed.		Correct the program so that the parameter for the relevant input variable does not change when the relevant instruction is re-executed.		Check the manual to see if the input variables to the relevant motion control instruction can be changed by re-execution. Write the program so that the input parameters for any input variable that cannot be changed do not change upon re-execution.	
Attached information	None					
Precautions/Remarks	None					

Event name	Motion Control Instruction Re-execution Disabled (Master Axis)		Event code	54590000 hex		
Meaning	An attempt was made to change the parameter for the <i>Master</i> input variable when re-executing a motion control instruction. (This input variable cannot be changed when re-executing an instruction.)					
Source	Motion Control Function Module		Source details	Axis	Detection timing	At instruction re-execution
Error attributes	Level	Minor fault	Recovery	Error reset	Log category	System
Effects	User program	Continues.	Operation	Operation is not possible for relevant axis. Relevant axis decelerates to a stop if it is in motion.		
System-defined variables	Variable	Data type		Name		
	_MC_AX[*].MFAultLvl.Active	BOOL		Axis Minor Fault Occurrence		
Cause and correction	Assumed cause		Correction		Prevention	
	A parameter for an input variable that cannot be changed for re-execution was changed.		Correct the program so that the parameter for the relevant input variable does not change when the relevant instruction is re-executed.		Check the manual to see if the input variables to the relevant motion control instruction can be changed by re-execution. Write the program so that the input parameters for any input variable that cannot be changed do not change upon re-execution.	
Attached information	None					
Precautions/Remarks	None					

Event name	Motion Control Instruction Re-execution Disabled (MasterOffset)		Event code	545A0000 hex		
Meaning	An attempt was made to change the parameter for the <i>MasterOffset</i> input variable when re-executing a motion control instruction. (This input variable cannot be changed when re-executing an instruction.)					
Source	Motion Control Function Module		Source details	Axis	Detection timing	At instruction re-execution
Error attributes	Level	Minor fault	Recovery	Error reset	Log category	System
Effects	User program	Continues.	Operation	Operation is not possible for relevant axis. Relevant axis decelerates to a stop if it is in motion.		
System-defined variables	Variable	Data type		Name		
	_MC_AX[*].MFAultLvl.Active	BOOL		Axis Minor Fault Occurrence		
Cause and correction	Assumed cause		Correction		Prevention	
	A parameter for an input variable that cannot be changed for re-execution was changed.		Correct the program so that the parameter for the relevant input variable does not change when the relevant instruction is re-executed.		Check the manual to see if the input variables to the relevant motion control instruction can be changed by re-execution. Write the program so that the input parameters for any input variable that cannot be changed do not change upon re-execution.	
Attached information	None					
Precautions/Remarks	None					

Event name	Motion Control Instruction Re-execution Disabled (MasterScaling)		Event code	545B0000 hex		
Meaning	An attempt was made to change the parameter for the <i>MasterScaling</i> input variable when re-executing a motion control instruction. (This input variable cannot be changed when re-executing an instruction.)					
Source	Motion Control Function Module		Source details	Axis	Detection timing	At instruction re-execution
Error attributes	Level	Minor fault	Recovery	Error reset	Log category	System
Effects	User program	Continues.	Operation	Operation is not possible for relevant axis. Relevant axis decelerates to a stop if it is in motion.		
System-defined variables	Variable		Data type		Name	
	_MC_AX[*].MFAultLvl.Active		BOOL		Axis Minor Fault Occurrence	
Cause and correction	Assumed cause		Correction		Prevention	
	A parameter for an input variable that cannot be changed for re-execution was changed.		Correct the program so that the parameter for the relevant input variable does not change when the relevant instruction is re-executed.		Check the manual to see if the input variables to the relevant motion control instruction can be changed by re-execution. Write the program so that the input parameters for any input variable that cannot be changed do not change upon re-execution.	
Attached information	None					
Precautions/Remarks	None					

Event name	Motion Control Instruction Re-execution Disabled (MasterStartDistance)		Event code	545C0000 hex		
Meaning	An attempt was made to change the parameter for the <i>MasterStartDistance</i> input variable when re-executing a motion control instruction. (This input variable cannot be changed when re-executing an instruction.)					
Source	Motion Control Function Module		Source details	Axis	Detection timing	At instruction re-execution
Error attributes	Level	Minor fault	Recovery	Error reset	Log category	System
Effects	User program	Continues.	Operation	Operation is not possible for relevant axis. Relevant axis decelerates to a stop if it is in motion.		
System-defined variables	Variable		Data type		Name	
	_MC_AX[*].MFAultLvl.Active		BOOL		Axis Minor Fault Occurrence	
Cause and correction	Assumed cause		Correction		Prevention	
	A parameter for an input variable that cannot be changed for re-execution was changed.		Correct the program so that the parameter for the relevant input variable does not change when the relevant instruction is re-executed.		Check the manual to see if the input variables to the relevant motion control instruction can be changed by re-execution. Write the program so that the input parameters for any input variable that cannot be changed do not change upon re-execution.	
Attached information	None					
Precautions/Remarks	None					

Event name	Motion Control Instruction Re-execution Disabled (Continuous)		Event code	545D0000 hex		
Meaning	An attempt was made to change the parameter for the <i>Continuous</i> input variable when re-executing a motion control instruction. (This input variable cannot be changed when re-executing an instruction.)					
Source	Motion Control Function Module		Source details	Axis	Detection timing	At instruction re-execution
Error attributes	Level	Minor fault	Recovery	Error reset	Log category	System
Effects	User program	Continues.	Operation	Operation is not possible for relevant axis. Relevant axis decelerates to a stop if it is in motion.		
System-defined variables	Variable	Data type		Name		
	_MC_AX[*].MFAultLvl.Active	BOOL		Axis Minor Fault Occurrence		
Cause and correction	Assumed cause		Correction		Prevention	
	A parameter for an input variable that cannot be changed for re-execution was changed.		Correct the program so that the parameter for the relevant input variable does not change when the relevant instruction is re-executed.		Check the manual to see if the input variables to the relevant motion control instruction can be changed by re-execution. Write the program so that the input parameters for any input variable that cannot be changed do not change upon re-execution.	
Attached information	None					
Precautions/Remarks	None					

Event name	Motion Control Instruction Re-execution Disabled (MoveMode)		Event code	545E0000 hex		
Meaning	An attempt was made to change the parameter for the <i>MoveMode</i> input variable when re-executing a motion control instruction. (This input variable cannot be changed when re-executing an instruction.)					
Source	Motion Control Function Module		Source details	Axis	Detection timing	At instruction re-execution
Error attributes	Level	Minor fault	Recovery	Error reset	Log category	System
Effects	User program	Continues.	Operation	Operation is not possible for relevant axis. Relevant axis decelerates to a stop if it is in motion.		
System-defined variables	Variable	Data type		Name		
	_MC_AX[*].MFAultLvl.Active	BOOL		Axis Minor Fault Occurrence		
Cause and correction	Assumed cause		Correction		Prevention	
	A parameter for an input variable that cannot be changed for re-execution was changed.		Correct the program so that the parameter for the relevant input variable does not change when the relevant instruction is re-executed.		Check the manual to see if the input variables to the relevant motion control instruction can be changed by re-execution. Write the program so that the input parameters for any input variable that cannot be changed do not change upon re-execution.	
Attached information	None					
Precautions/Remarks	None					

Event name	Illegal Auxiliary Axis Specification			Event code	545F0000 hex
Meaning	The axis specified for the <i>Auxiliary</i> input variable to a motion control instruction does not exist.				
Source	Motion Control Function Module		Source details	Axis	Detection timing At instruction execution
Error attributes	Level	Minor fault	Recovery	Error reset	Log category System
Effects	User program	Continues.	Operation	Operation is not possible for relevant slave axis. The slave axis decelerates to a stop if it is in motion.	
System-defined variables	Variable		Data type		Name
	_MC_AX[*].MFAultLvl.Active		BOOL		Axis Minor Fault Occurrence
Cause and correction	Assumed cause		Correction		Prevention
	An axis does not exist for the variable specified for the <i>Auxiliary</i> input variable to the instruction.		Correct the instruction so that the variable exists for the axis that was specified for the instruction.		Make sure to specify variables that exist when specifying variables for the input parameters to an instruction.
Attached information	None				
Precautions/Remarks	None				

Event name	Illegal Axis Specification			Event code	54600000 hex
Meaning	The axis specified for the <i>Axis</i> input variable to a motion control instruction does not exist.				
Source	Motion Control Function Module		Source details	MC Common	Detection timing At instruction execution
Error attributes	Level	Minor fault	Recovery	Error reset	Log category System
Effects	User program	Continues.	Operation	The instruction is not executed.	
System-defined variables	Variable		Data type		Name
	_MC_COM.MFAultLvl.Active		BOOL		MC Common Minor Fault Occurrence
Cause and correction	Assumed cause		Correction		Prevention
	An axis does not exist for the variable specified for the <i>Axis</i> input variable to the instruction.		Correct the instruction so that the variable exists for the axis that was specified for the instruction.		Make sure to specify a variable that exists when specifying a variable for an input parameter to an instruction.
Attached information	None				
Precautions/Remarks	None				

Event name	Illegal Axes Group Specification		Event code	54610000 hex	
Meaning	The axes group specified for the <i>AxesGroup</i> input variable to a motion control instruction does not exist or is not a used group.				
Source	Motion Control Function Module		Source details	MC Common	Detection timing At instruction execution
Error attributes	Level	Minor fault	Recovery	Error reset	Log category System
Effects	User program	Continues.	Operation	The instruction is not executed.	
System-defined variables	Variable		Data type		Name
	_MC_COM.MFaultLvl.Active		BOOL		MC Common Minor Fault Occurrence
Cause and correction	Assumed cause		Correction		Prevention
	An axes group does not exist for the variable specified for the <i>AxesGroup</i> input variable to the instruction.		Correct the specification for the instruction so that the specified axes group exists.		Specify a variable that exists when specifying a variable for an input parameter to an instruction.
	The axes group specified for the <i>AxesGroup</i> input variable to the instruction is not specified as a used group.		Correct the axes group specified by the instruction to a used group.		Set a used axes group for the <i>AxesGroup</i> input variable to the instruction.
Attached information	None				
Precautions/Remarks	None				

Event name	Illegal Master Axis Specification			Event code	54620000 hex	
Meaning	The axis that is specified for the <i>Master</i> input variable to a motion control instruction is not correct.					
Source	Motion Control Function Module	Source details	MC common or axis	Detection timing	At instruction execution	
Error attributes	Level	Minor fault	Recovery	Error reset	Log category	System
Effects	User program	Continues.	Operation	Operation is not possible for relevant slave axis. The slave axis decelerates to a stop if it is in motion.		
System-defined variables	Variable	Data type		Name		
	_MC_COM.MFaultLvl.Active	BOOL		MC Common Minor Fault Occurrence		
	_MC_AX[*].MFaultLvl.Active	BOOL		Axis Minor Fault Occurrence		
Cause and correction	Assumed cause	Correction		Prevention		
	An axis does not exist for the variable specified for the <i>Master</i> input variable to the instruction.	Correct the instruction so that the variable exists for the axis that was specified for the instruction.		Specify a variable that exists when specifying a variable for an input parameter to an instruction.		
	The axis that was specified for the <i>Master</i> input variable to the MC_Phasing (Shift Master Axis Phase) instruction is not the master axis for syncing.	Correct the variable that is input to the <i>Master</i> input variable of the MC_Phasing (Shift Master Axis Phase) instruction to the axis variable that is specified as the master axis of the synchronized control instruction.		Set the variable that is input to the <i>Master</i> input variable of the MC_Phasing (Shift Master Axis Phase) instruction to the axis variable that is specified as the master axis of the synchronized control instruction.		
	The master axis and a slave axis are not assigned to the same task.	Assign the axes that are input to the <i>Master</i> and <i>Slave</i> input variables to the instruction to the same task.		Specify axes that are assigned to the same tasks for the master and slave axes.		
Attached information	None					
Precautions/Remarks	None					

Event name	Motion Control Instruction Re-execution Disabled (SlaveOffset)		Event code	54630000 hex		
Meaning	An attempt was made to change the <i>SlaveOffset</i> input variable when re-executing a motion control instruction. (This input variable cannot be changed when re-executing an instruction.)					
Source	Motion Control Function Module		Source details	Axis	Detection timing	At instruction re-execution
Error attributes	Level	Minor fault	Recovery	Error reset	Log category	System
Effects	User program	Continues.	Operation	Operation is not possible for relevant axis. Relevant axis decelerates to a stop if it is in motion.		
System-defined variables	Variable	Data type		Name		
	_MC_AX[*].MFaultLvl.Active	BOOL		Axis Minor Fault Occurrence		
Cause and correction	Assumed cause		Correction		Prevention	
	A parameter for an input variable that cannot be changed for re-execution was changed.		Correct the program so that the parameter for the relevant input variable does not change when the relevant instruction is re-executed.		Check the manual to see if the input variables to the relevant motion control instruction can be changed by re-execution. Write the program so that the input parameters for any input variable that cannot be changed do not change upon re-execution.	
Attached information	None					
Precautions/Remarks	None					

Event name	Motion Control Instruction Re-execution Disabled (SlaveScaling)		Event code	54640000 hex		
Meaning	An attempt was made to change the <i>SlaveScaling</i> input variable when re-executing a motion control instruction. (This input variable cannot be changed when re-executing an instruction.)					
Source	Motion Control Function Module		Source details	Axis	Detection timing	At instruction re-execution
Error attributes	Level	Minor fault	Recovery	Error reset	Log category	System
Effects	User program	Continues.	Operation	Operation is not possible for relevant axis. Relevant axis decelerates to a stop if it is in motion.		
System-defined variables	Variable	Data type		Name		
	_MC_AX[*].MFaultLvl.Active	BOOL		Axis Minor Fault Occurrence		
Cause and correction	Assumed cause		Correction		Prevention	
	A parameter for an input variable that cannot be changed for re-execution was changed.		Correct the program so that the parameter for the relevant input variable does not change when the relevant instruction is re-executed.		Check the manual to see if the input variables to the relevant motion control instruction can be changed by re-execution. Write the program so that the input parameters for any input variable that cannot be changed do not change upon re-execution.	
Attached information	None					
Precautions/Remarks	None					

Event name	Motion Control Instruction Re-execution Disabled (StartPosition)		Event code	54650000 hex		
Meaning	An attempt was made to change the <i>StartPosition</i> input variable when re-executing a motion control instruction. (This input variable cannot be changed when re-executing an instruction.)					
Source	Motion Control Function Module		Source details	Axis	Detection timing	At instruction re-execution
Error attributes	Level	Minor fault	Recovery	Error reset	Log category	System
Effects	User program	Continues.	Operation	Operation is not possible for relevant axis. Relevant axis decelerates to a stop if it is in motion.		
System-defined variables	Variable		Data type		Name	
	_MC_AX[*].MFAultLvl.Active		BOOL		Axis Minor Fault Occurrence	
Cause and correction	Assumed cause		Correction		Prevention	
	A parameter for an input variable that cannot be changed for re-execution was changed.		Correct the program so that the parameter for the relevant input variable does not change when the relevant instruction is re-executed.		Check the manual to see if the input variables to the relevant motion control instruction can be changed by re-execution. Write the program so that the input parameters for any input variable that cannot be changed do not change upon re-execution.	
Attached information	None					
Precautions/Remarks	None					

Event name	Instruction Execution Error with Undefined Home		Event code	54660000 hex		
Meaning	High-speed homing or an interpolation instruction was executed when home was undefined.					
Source	Motion Control Function Module		Source details	Axis/axes group	Detection timing	At instruction execution
Error attributes	Level	Minor fault	Recovery	Error reset	Log category	System
Effects	User program	Continues.	Operation	<p>If "axis" is given for the source details, operation is not possible for relevant axis. Relevant axis decelerates to a stop if it is in motion.</p> <p>If "axes group" is given for the source details, operation is not possible for relevant axes group. Relevant axes group decelerates to a stop if it is in motion.</p>		
System-defined variables	Variable	Data type		Name		
	_MC_AX[*].MFAultLvl.Active	BOOL		Axis Minor Fault Occurrence		
	_MC_GRP[*].MFAultLvl.Active	BOOL		Axes Group Minor Fault Occurrence		
Cause and correction	Assumed cause	Correction		Prevention		
	High-speed homing was executed when home was undefined.	Execute the high-speed homing operation only after homing to define home.		Execute the high-speed homing instruction only after home is defined by homing.		
	<p>An interpolation instruction was executed for an axes group that includes an axis with no defined home.</p> <p>One of the following robot instructions was executed for an axes group that includes a logical axis with no defined home.</p> <ul style="list-style-type: none"> • MC_SetKinTransform (Set Kinematics Transformation) instruction • MC_MoveTimeAbsolute (Time-specified Absolute Positioning) instruction • MC_SyncLinearConveyor (Start Conveyor Synchronization) instruction • MC_SyncOut (End Synchronization) instruction • MC_GroupMon (Group Monitor) instruction • MC_RobotJog (Axes Group Jog) instruction 	Perform homing to define home for all axes in the axes group before executing the interpolation instruction.		Perform homing to define home for all axes in the axes group before executing the interpolation instruction.		
Attached information	<p>Attached Information 1: Depends on the source details</p> <ul style="list-style-type: none"> • Axis: 0 • Axes group: Logical axis number 					
Precautions/Remarks	If you execute the Set Position instruction after performing homing, home will again be undefined. You must perform homing again to define home in this case.					

Event name	Motion Control Instruction Re-execution Disabled (Position Type)		Event code	54670000 hex		
Meaning	An attempt was made to change the <i>ReferenceType</i> input variable when re-executing a motion control instruction. (This input variable cannot be changed when re-executing an instruction.)					
Source	Motion Control Function Module		Source details	Axis	Detection timing	At instruction re-execution
Error attributes	Level	Minor fault	Recovery	Error reset	Log category	System
Effects	User program	Continues.	Operation	Operation is not possible for relevant axis. Relevant axis decelerates to a stop if it is in motion.		
System-defined variables	Variable	Data type		Name		
	_MC_AX[*].MFAultLvl.Active	BOOL		Axis Minor Fault Occurrence		
Cause and correction	Assumed cause		Correction		Prevention	
	A parameter for an input variable that cannot be changed for re-execution was changed.		Correct the program so that the parameter for the relevant input variable does not change when the relevant instruction is re-executed.		Check the manual to see if the input variables to the relevant motion control instruction can be changed by re-execution. Write the program so that the input parameters for any input variable that cannot be changed do not change upon re-execution.	
Attached information	None					
Precautions/Remarks	None					

Event name	Unused Axis Specification for Master Axis		Event code	54680000 hex		
Meaning	The master axis specified for a motion control instruction is an unused axis.					
Source	Motion Control Function Module		Source details	Axis	Detection timing	At instruction execution
Error attributes	Level	Minor fault	Recovery	Error reset	Log category	System
Effects	User program	Continues.	Operation	Operation is not possible for relevant slave axis. Relevant slave axis decelerates to a stop if it is in motion.		
System-defined variables	Variable	Data type		Name		
	_MC_AX[*].MFAultLvl.Active	BOOL		Axis Minor Fault Occurrence		
Cause and correction	Assumed cause		Correction		Prevention	
	The master axis specified for a motion control instruction is an unused axis.		Set a used axis for the master axis that is specified for the instruction.		Make sure the master axis specified for the motion control instruction is a used axis.	
Attached information	None					
Precautions/Remarks	None					

Event name	First Position Setting Out of Range			Event code	54690000 hex	
Meaning	The parameter specified for the <i>FirstPosition</i> input variable to a motion control instruction is out of range.					
Source	Motion Control Function Module		Source details	Axis	Detection timing	At instruction execution
Error attributes	Level	Minor fault	Recovery	Error reset	Log category	System
Effects	User program	Continues.	Operation	Operation is not possible for relevant axis. Relevant axis decelerates to a stop if it is in motion.		
System-defined variables	Variable		Data type		Name	
	_MC_AX[*].MFAultLvl.Active		BOOL		Axis Minor Fault Occurrence	
Cause and correction	Assumed cause		Correction		Prevention	
	Instruction input parameter exceeded the valid range of the input variable.		Correct the parameter so that the valid range of the input variable is not exceeded for the relevant instruction.		Set the input parameter to the instruction so that the valid range of the input variable is not exceeded.	
Attached information	None					
Precautions/Remarks	None					

Event name	Last Position Setting Out of Range			Event code	546A0000 hex	
Meaning	The parameter specified for the <i>LastPosition</i> input variable to a motion control instruction is out of range.					
Source	Motion Control Function Module		Source details	Axis	Detection timing	At instruction execution
Error attributes	Level	Minor fault	Recovery	Error reset	Log category	System
Effects	User program	Continues.	Operation	Operation is not possible for relevant axis. Relevant axis decelerates to a stop if it is in motion.		
System-defined variables	Variable		Data type		Name	
	_MC_AX[*].MFAultLvl.Active		BOOL		Axis Minor Fault Occurrence	
Cause and correction	Assumed cause		Correction		Prevention	
	Instruction input parameter exceeded the valid range of the input variable.		Correct the parameter so that the valid range of the input variable is not exceeded for the relevant instruction.		Set the input parameter to the instruction so that the valid range of the input variable is not exceeded.	
Attached information	None					
Precautions/Remarks	None					

Event name	Illegal First/Last Position Size Relationship (Linear Mode)		Event code	546B0000 hex		
Meaning	The parameter specified for the <i>LastPosition</i> input variable to a motion control instruction is smaller than the parameter specified for the <i>FirstPosition</i> input variable.					
Source	Motion Control Function Module		Source details	Axis	Detection timing	At instruction execution
Error attributes	Level	Minor fault	Recovery	Error reset	Log category	System
Effects	User program	Continues.	Operation	Operation is not possible for relevant axis. Relevant axis decelerates to a stop if it is in motion.		
System-defined variables	Variable	Data type		Name		
	_MC_AX[*].MFaultLvl.Active	BOOL		Axis Minor Fault Occurrence		
Cause and correction	Assumed cause	Correction		Prevention		
	The value of the <i>LastPosition</i> input parameter is less than the value of the <i>FirstPosition</i> input variable for the instruction when the Count Mode is set to Linear Mode.	Correct the program so that the value of the <i>LastPosition</i> specified for the instruction is larger than the value of the <i>FirstPosition</i> . Or, change the value of the Count Mode to Rotary Mode.		Write the program so that the value of the <i>LastPosition</i> specified for the instruction is larger than the value of the <i>FirstPosition</i> . Or, check to make sure that the Count Mode of the relevant axis is set to Rotary Mode.		
Attached information	None					
Precautions/Remarks	None					

Event name	Master Sync Start Position Setting Out of Range		Event code	546C0000 hex		
Meaning	The parameter specified for the <i>MasterSyncPosition</i> input variable to a motion control instruction is out of range.					
Source	Motion Control Function Module		Source details	Axis	Detection timing	At instruction execution
Error attributes	Level	Minor fault	Recovery	Error reset	Log category	System
Effects	User program	Continues.	Operation	Operation is not possible for relevant slave axis. Relevant slave axis decelerates to a stop if it is in motion.		
System-defined variables	Variable	Data type		Name		
	_MC_AX[*].MFaultLvl.Active	BOOL		Axis Minor Fault Occurrence		
Cause and correction	Assumed cause	Correction		Prevention		
	Instruction input parameter exceeded the valid range of the input variable.	Correct the parameter so that the valid range of the input variable is not exceeded for the relevant instruction.		Set the input parameter to the instruction so that the valid range of the input variable is not exceeded.		
Attached information	None					
Precautions/Remarks	None					

Event name	Slave Sync Start Position Setting Out of Range		Event code	546D0000 hex		
Meaning	The parameter specified for the <i>SlaveSyncPosition</i> input variable to a motion control instruction is out of range.					
Source	Motion Control Function Module		Source details	Axis	Detection timing	At instruction execution
Error attributes	Level	Minor fault	Recovery	Error reset	Log category	System
Effects	User program	Continues.	Operation	Operation is not possible for relevant axis. Relevant axis decelerates to a stop if it is in motion.		
System-defined variables	Variable	Data type		Name		
	_MC_AX[*].MFAultLvl.Active	BOOL		Axis Minor Fault Occurrence		
Cause and correction	Assumed cause		Correction		Prevention	
	Instruction input parameter exceeded the valid range of the input variable.		Correct the parameter so that the valid range of the input variable is not exceeded for the relevant instruction.		Set the input parameter to the instruction so that the valid range of the input variable is not exceeded.	
Attached information	None					
Precautions/Remarks	None					

Event name	Duplicate Latch ID for Trigger Input Condition		Event code	546E0000 hex		
Meaning	The same latch ID was specified for more than one motion control instruction.					
Source	Motion Control Function Module		Source details	Axis	Detection timing	At instruction execution
Error attributes	Level	Minor fault	Recovery	Error reset	Log category	System
Effects	User program	Continues.	Operation	Operation is not possible for relevant axis. Relevant axis decelerates to a stop if it is in motion.		
System-defined variables	Variable	Data type		Name		
	_MC_AX[*].MFAultLvl.Active	BOOL		Axis Minor Fault Occurrence		
Cause and correction	Assumed cause		Correction		Prevention	
	The same latch ID is used simultaneously for more than one of the following instructions: MC_TouchProbe (Enable External Latch) instruction, MC_MoveLink (Synchronous Positioning) instruction, and MC_MoveFeed (Interrupt Feeding) instruction.		Correct the program so that the same latch ID is not used by another instruction at the same time as this instruction. Either use a different latch ID or do not execute any instructions that use the same latch ID at the same time. Both latch 1 and latch 2 are treated as being in use during execution of the MC_Home or MC_HomeWithParameter instruction.		Do not use the same latch ID simultaneously for more than one of the following instructions: MC_TouchProbe (Enable External Latch) instruction, MC_MoveLink (Synchronous Positioning) instruction, and MC_MoveFeed (Interrupt Feeding) instruction.	
	The MC_AbortTrigger (Disable External Latch) instruction was executed to cancel a latch that was used by an instruction other than the MC_TouchProbe (Enable External Latch) instruction.		Do not use the Disable External Latch instruction to cancel a latch that is used by an instruction other than the Enable External Latch instruction.		Do not execute the Disable External Latch instruction for a latch that is used by an instruction other than the Enable External Latch instruction.	
Attached information	None					
Precautions/Remarks	If you decide to change the latch ID, make sure that same latch ID is not used by any other instructions.					

Event name	Jerk Override Factor Out of Range		Event code	546F0000 hex		
Meaning	The parameter specified for the <i>JerkFactor</i> input variable to a motion control instruction is out of range.					
Source	Motion Control Function Module		Source details	Axis/axes group	Detection timing	At instruction execution
Error attributes	Level	Minor fault	Recovery	Error reset	Log category	System
Effects	User program	Continues.	Operation	Operation is not possible for relevant axis. Relevant axis decelerates to a stop if it is in motion.		
System-defined variables	Variable		Data type		Name	
	_MC_AX[*].MFaultLvl.Active		BOOL		Axis Minor Fault Occurrence	
Cause and correction	Assumed cause		Correction		Prevention	
	Instruction input parameter exceeded the valid range of the input variable.		Correct the parameter so that the valid range of the input variable is not exceeded for the relevant instruction.		Set the input parameter to the instruction so that the valid range of the input variable is not exceeded.	
Attached information	None					
Precautions/Remarks	None					

Event name	Acceleration/Deceleration Override Factor Out of Range		Event code	54700000 hex		
Meaning	The parameter specified for the <i>AccFactor</i> input variable to a motion control instruction is out of range.					
Source	Motion Control Function Module		Source details	Axis/axes group	Detection timing	At instruction execution
Error attributes	Level	Minor fault	Recovery	Error reset	Log category	System
Effects	User program	Continues.	Operation	Operation is not possible for relevant axis. Relevant axis decelerates to a stop if it is in motion.		
System-defined variables	Variable		Data type		Name	
	_MC_AX[*].MFaultLvl.Active		BOOL		Axis Minor Fault Occurrence	
Cause and correction	Assumed cause		Correction		Prevention	
	Instruction input parameter exceeded the valid range of the input variable.		Correct the parameter so that the valid range of the input variable is not exceeded for the relevant instruction.		Set the input parameter to the instruction so that the valid range of the input variable is not exceeded.	
Attached information	None					
Precautions/Remarks	None					

Event name	First Position Method Specification Out of Range		Event code	54710000 hex		
Meaning	The parameter specified for the <i>StartMode</i> input variable to a motion control instruction is out of range.					
Source	Motion Control Function Module		Source details	Axis	Detection timing	At instruction execution
Error attributes	Level	Minor fault	Recovery	Error reset	Log category	System
Effects	User program	Continues.	Operation	Operation is not possible for relevant axis. Relevant axis decelerates to a stop if it is in motion.		
System-defined variables	Variable		Data type		Name	
	_MC_AX[*].MFAultLvl.Active		BOOL		Axis Minor Fault Occurrence	
Cause and correction	Assumed cause		Correction		Prevention	
	Instruction input parameter exceeded the valid range of the input variable.		Correct the parameter so that the valid range of the input variable is not exceeded for the relevant instruction.		Set the input parameter to the instruction so that the valid range of the input variable is not exceeded.	
Attached information	None					
Precautions/Remarks	None					

Event name	Motion Control Instruction Re-execution Disabled (First Position Method)		Event code	54720000 hex		
Meaning	An attempt was made to change the <i>StartMode</i> input variable when re-executing a motion control instruction. (This input variable cannot be changed when re-executing an instruction.)					
Source	Motion Control Function Module		Source details	Axis	Detection timing	At instruction re-execution
Error attributes	Level	Minor fault	Recovery	Error reset	Log category	System
Effects	User program	Continues.	Operation	Operation is not possible for relevant axis. Relevant axis decelerates to a stop if it is in motion.		
System-defined variables	Variable		Data type		Name	
	_MC_AX[*].MFAultLvl.Active		BOOL		Axis Minor Fault Occurrence	
Cause and correction	Assumed cause		Correction		Prevention	
	A parameter for an input variable that cannot be changed for re-execution was changed.		Correct the program so that the parameter for the relevant input variable does not change when the relevant instruction is re-executed.		Check the manual to see if the input variables to the relevant motion control instruction can be changed by re-execution. Write the program so that the input parameters for any input variable that cannot be changed do not change upon re-execution.	
Attached information	None					
Precautions/Remarks	None					

3 Error Descriptions and Corrections

Event name	Unused Axis Specification for Auxiliary Axis		Event code	54740000 hex		
Meaning	The axis specified for the <i>Auxiliary</i> input variable to a motion control instruction is an unused axis.					
Source	Motion Control Function Module		Source details	Axis	Detection timing	At instruction execution
Error attributes	Level	Minor fault	Recovery	Error reset	Log category	System
Effects	User program	Continues.	Operation	Operation is not possible for relevant slave axis. Relevant slave axis decelerates to a stop if it is in motion.		
System-defined variables	Variable	Data type		Name		
	_MC_AX[*].MFaultLvl.Active	BOOL		Axis Minor Fault Occurrence		
Cause and correction	Assumed cause		Correction		Prevention	
	The axis specified for the <i>Auxiliary</i> input variable to the instruction is an unused axis.		Set a used axis for the axis that is specified for the instruction. Or, correct the parameter so that it specifies a used axis.		Make sure that the axis specified for the instruction is a used axis.	
Attached information	None					
Precautions/Remarks	None					

Event name	Position Gear Value Error		Event code	54750000 hex		
Meaning	Synchronized motion is not possible for the velocity, acceleration rate, and deceleration rate that were input to a motion control instruction.					
Source	Motion Control Function Module		Source details	Axis	Detection timing	At instruction execution or during instruction execution
Error attributes	Level	Minor fault	Recovery	Error reset	Log category	System
Effects	User program	Continues.	Operation	Operation is not possible for relevant slave axis. Relevant slave axis decelerates to a stop if it is in motion.		
System-defined variables	Variable	Data type		Name		
	_MC_AX[*].MFaultLvl.Active	BOOL		Axis Minor Fault Occurrence		
Cause and correction	Assumed cause		Correction		Prevention	
	The specified synchronized motion cannot be performed at the velocity, acceleration rate, or deceleration rate that is input to the instruction.		Correct the program to enable synchronized motion according to the operating specifications of the MC_GearInPos (Positioning Gear Operation) or MC_GearInPos2 (Positioning Gear Operation2) instruction. (NJ/NX-series)		Check the processing of the relevant instruction and set a value that allows for synchronized motion.	
			Correct the program to enable synchronized motion according to the operating specifications of the MC_GearInPos (Positioning Gear Operation) instruction. (NY-series)			
Attached information	None					
Precautions/Remarks	None					

Event name	Position Gear Master Axis Zero Velocity		Event code	54760000 hex		
Meaning	The velocity of the master axis was zero when a motion control instruction was started.					
Source	Motion Control Function Module		Source details	Axis	Detection timing	At instruction execution or during instruction execution
Error attributes	Level	Minor fault	Recovery	Error reset	Log category	System
Effects	User program	Continues.	Operation	Operation is not possible for relevant slave axis. Relevant slave axis decelerates to a stop if it is in motion.		
System-defined variables	Variable	Data type		Name		
	_MC_AX[*].MFAultLvl.Active	BOOL		Axis Minor Fault Occurrence		
Cause and correction	Assumed cause		Correction		Prevention	
	The velocity of the master axis was 0 when the instruction was started.		Correct the program so that the velocity of the master axis is not 0 when the instruction is started.		Write the program so that the velocity of the master axis is not 0 when the instruction is started.	
Attached information	None					
Precautions/Remarks	None					

Event name	Target Position Setting Out of Range		Event code	54780000 hex		
Meaning	The parameter specified for the <i>Position</i> input variable to a motion control instruction is out of range.					
Source	Motion Control Function Module		Source details	Axis/axes group	Detection timing	At instruction execution
Error attributes	Level	Minor fault	Recovery	Error reset	Log category	System
Effects	User program	Continues.	Operation	If "axis" is given for the source details, operation is not possible for relevant axis. Relevant axis decelerates to a stop if it is in motion. If "axes group" is given for the source details, operation is not possible for relevant axes group. Relevant axes group decelerates to a stop if it is in motion.		
System-defined variables	Variable	Data type		Name		
	_MC_AX[*].MFAultLvl.Active	BOOL		Axis Minor Fault Occurrence		
	_MC_GRP[*].MFAultLvl.Active	BOOL		Axes Group Minor Fault Occurrence		
Cause and correction	Assumed cause		Correction		Prevention	
	Instruction input parameter exceeded the valid range of the input variable.		Correct the parameter so that the valid range of the input variable is not exceeded for the relevant instruction.		Set the input parameter to the instruction so that the valid range of the input variable is not exceeded.	
	The target position of a Rotary Mode axis is not within the ring setting range.		Correct the target position of the Rotary Mode axis to within the ring setting range.		Set the target position of the Rotary Mode axis to within the ring setting range.	
Attached information	Attached Information 1: Depends on the source details <ul style="list-style-type: none"> • Axis: 0 • Axes group: Element number that is out of range in the <i>Position</i> input variable to the instruction. 					
Precautions/Remarks	None					

Event name	Travel Distance Out of Range		Event code	54790000 hex		
Meaning	The parameter that was specified for the <i>Distance</i> input variable to a motion control instruction is out of range or the target position with the value of <i>Distance</i> added is out of range.					
Source	Motion Control Function Module		Source details	Axis/axes group	Detection timing	At instruction execution
Error attributes	Level	Minor fault	Recovery	Error reset	Log category	System
Effects	User program	Continues.	Operation	<p>If “axis” is given for the source details, operation is not possible for relevant axis. Relevant axis decelerates to a stop if it is in motion.</p> <p>If “axes group” is given for the source details, operation is not possible for relevant axes group. Relevant axes group decelerates to a stop if it is in motion.</p>		
System-defined variables	Variable		Data type		Name	
	_MC_AX[*].MFAultLvl.Active		BOOL		Axis Minor Fault Occurrence	
	_MC_GRP[*].MFAultLvl.Active		BOOL		Axes Group Minor Fault Occurrence	
Cause and correction	Assumed cause		Correction		Prevention	
	<p>The absolute value of the instruction input parameter exceeded the range of 40-bit data when it is converted to pulses.</p> <p>For a Linear Mode axis, the target position with the travel distance added exceeded signed 40-bit data when the absolute value is converted to pulses.</p>		Correct the input parameter specified for the <i>Distance</i> input variable of the instruction so that the travel distance and the target position are not out of range.		Write the program so that the travel distance and the target position for the instruction are not out of range.	
Attached information	None					
Precautions/Remarks	None					

Event name	Cam Table Start Point Setting Out of Range		Event code	547A0000 hex		
Meaning	The parameter specified for the <i>StartPosition</i> input variable to a motion control instruction is out of range.					
Source	Motion Control Function Module		Source details	Axis	Detection timing	At instruction execution
Error attributes	Level	Minor fault	Recovery	Error reset	Log category	System
Effects	User program	Continues.	Operation	Operation is not possible for relevant axis. Relevant axis decelerates to a stop if it is in motion.		
System-defined variables	Variable		Data type		Name	
	_MC_AX[*].MFAultLvl.Active		BOOL		Axis Minor Fault Occurrence	
Cause and correction	Assumed cause		Correction		Prevention	
	Instruction input parameter exceeded the valid range of the input variable.		Correct the parameter so that the valid range of the input variable is not exceeded for the relevant instruction.		Set the input parameter to the instruction so that the valid range of the input variable is not exceeded.	
Attached information	None					
Precautions/Remarks	None					

Event name	Cam Master Axis Following First Position Setting Out of Range		Event code	547B0000 hex		
Meaning	The parameter specified for the <i>MasterStartDistance</i> input variable to a motion control instruction is out of range.					
Source	Motion Control Function Module		Source details	Axis	Detection timing	At instruction execution
Error attributes	Level	Minor fault	Recovery	Error reset	Log category	System
Effects	User program	Continues.	Operation	Operation is not possible for relevant axis. Relevant axis decelerates to a stop if it is in motion.		
System-defined variables	Variable	Data type		Name		
	_MC_AX[*].MFaultLvl.Active	BOOL		Axis Minor Fault Occurrence		
Cause and correction	Assumed cause		Correction		Prevention	
	Instruction input parameter exceeded the valid range of the input variable.		Correct the parameter so that the valid range of the input variable is not exceeded for the relevant instruction.		Set the input parameter to the instruction so that the valid range of the input variable is not exceeded.	
Attached information	None					
Precautions/Remarks	None					

Event name	Circular Interpolation Radius Setting Error		Event code	547C0000 hex		
Meaning	It was not possible to create a circular path for the specified radius when the radius method was specified for the MC_MoveCircular2D (Circular 2D Interpolation) instruction.					
Source	Motion Control Function Module		Source details	Axes group	Detection timing	At instruction execution
Error attributes	Level	Minor fault	Recovery	Error reset	Log category	System
Effects	User program	Continues.	Operation	Operation is not possible for relevant axes group. Relevant axes group decelerates to a stop if it is in motion.		
System-defined variables	Variable	Data type		Name		
	_MC_GRP[*].MFaultLvl.Active	BOOL		Axes Group Minor Fault Occurrence		
Cause and correction	Assumed cause		Correction		Prevention	
	For the MC_MoveCircular2D (Circular 2D Interpolation) instruction, it was not possible to create a circular path for the specified radius when the radius method was specified for circular interpolation.		Correct the radius so that the circular path can be created.		Check the processing of the relevant instruction and set a radius that allows the creation of a circular path.	
Attached information	None					
Precautions/Remarks	None					

3 Error Descriptions and Corrections

Event name	Circular Interpolation Radius Overflow		Event code	547D0000 hex		
Meaning	For the MC_MoveCircular2D (Circular 2D Interpolation) instruction, the radius of the circle exceeded the maximum value for the border point or center specification method.					
Source	Motion Control Function Module		Source details	Axes group	Detection timing	At instruction execution
Error attributes	Level	Minor fault	Recovery	Error reset	Log category	System
Effects	User program	Continues.	Operation	Operation is not possible for relevant axes group. Relevant axes group decelerates to a stop if it is in motion.		
System-defined variables	Variable		Data type		Name	
	_MC_GRP[*].MFAultLvl.Active		BOOL		Axes Group Minor Fault Occurrence	
Cause and correction	Assumed cause		Correction		Prevention	
	For the MC_MoveCircular2D (Circular 2D Interpolation) instruction, the radius of the circle exceeded 40-bit data when it is converted to pulses for the border point or center specification method.		Correct the input parameter so that the circle radius does not exceed 40-bit data when it is converted to pulses based on the operating specifications of the instruction. Border point specification: Start point, border point, and end point Center point specification: Start point, end point, and center point		Check the processing of the instruction and correct the input parameters so that the circle radius does not exceed 40-bit data it is when converted to pulses.	
Attached information	None					
Precautions/Remarks	If the maximum radius is exceeded when the radius specification method is used, a Border Point/Center Position/Radius Specification Out of Range error occurs.					

Event name	Circular Interpolation Setting Out of Range		Event code	547E0000 hex		
Meaning	The parameter specified for the <i>CircAxes</i> input variable to a motion control instruction is out of range.					
Source	Motion Control Function Module		Source details	Axes group	Detection timing	At instruction execution
Error attributes	Level	Minor fault	Recovery	Error reset	Log category	System
Effects	User program	Continues.	Operation	Operation is not possible for relevant axes group. Relevant axes group decelerates to a stop if it is in motion.		
System-defined variables	Variable		Data type		Name	
	_MC_GRP[*].MFAultLvl.Active		BOOL		Axes Group Minor Fault Occurrence	
Cause and correction	Assumed cause		Correction		Prevention	
	Instruction input parameter exceeded the valid range of the input variable.		Correct the parameter so that the valid range of the input variable is not exceeded for the relevant instruction.		Set the input parameters to the instruction so that the valid range of the input variables is not exceeded.	
	The axes that were specified in <i>CircAxes</i> are not included in the composition axes in the Axes Group Settings.		Set the axes that are specified for <i>CircAxes</i> so that they are in an axes group configuration.		Make sure that the axes that are specified for <i>CircAxes</i> are in an axes group configuration.	
	The same axis was specified for both axes of <i>CircAxes</i> .		Correct the settings so that the two axes specified for <i>CircAxes</i> are different axes.		Write the program so that the two axes specified for <i>CircAxes</i> are different axes.	
Attached information	None					
Precautions/Remarks	None					

Event name	Auxiliary/Slave Axis Numbers Not in Ascending Order		Event code	547F0000 hex		
Meaning	The values of the parameters for the <i>Auxiliary</i> and <i>Slave</i> input variables to a motion control instruction are not in ascending order.					
Source	Motion Control Function Module		Source details	Axis	Detection timing	At instruction execution
Error attributes	Level	Minor fault	Recovery	Error reset	Log category	System
Effects	User program	Continues.	Operation	Operation is not possible for relevant axis. Relevant axis decelerates to a stop if it is in motion.		
System-defined variables	Variable	Data type		Name		
	_MC_AX[*].MFAultLvl.Active	BOOL		Axis Minor Fault Occurrence		
Cause and correction	Assumed cause		Correction		Prevention	
	The parameters for the <i>Auxiliary</i> and <i>Slave</i> input variables to the instruction are not in ascending order.		Correct the axis numbers specified for the <i>Auxiliary</i> and <i>Slave</i> input parameters to the instruction so that they are in ascending order.		Write the program so that the axis numbers specified for <i>Auxiliary</i> and <i>Slave</i> are in ascending order.	
Attached information	None					
Precautions/Remarks	None					

Event name	Cam Table Property Ascending Data Error at Update		Event code	54800000 hex		
Meaning	A phase that was not in ascending order was found during calculating the number of valid data. Or, after calculations, the number of valid data is 0.					
Source	Motion Control Function Module		Source details	MC Common	Detection timing	During instruction execution
Error attributes	Level	Minor fault	Recovery	Error reset	Log category	System
Effects	User program	Continues.	Operation	Not affected.		
System-defined variables	Variable	Data type		Name		
	_MC_COM.MFAultLvl.Active	BOOL		MC Common Minor Fault Occurrence		
Cause and correction	Assumed cause		Correction		Prevention	
	A phase that was not in ascending order was found when calculating the number of valid data.		Place the phase data into ascending order in the cam table data.		Place the phase data into ascending order in the cam table data.	
	After calculations, the number of valid data is 0.		Correct the cam table data so that it includes phases that are not 0.		Create the cam table data so that it includes phases that are not 0.	
Attached information	None					
Precautions/Remarks	None					

Event name	MC_Write Target Out of Range		Event code	54810000 hex	
Meaning	The parameter specified for the <i>Target</i> input variable to a motion control instruction is out of range.				
Source	Motion Control Function Module		Source details	MC Common	Detection timing At instruction execution
Error attributes	Level	Minor fault	Recovery	Error reset	Log category System
Effects	User program	Continues.	Operation	Not affected.	
System-defined variables	Variable		Data type		Name
	_MC_COM.MFaultLvl.Active		BOOL		MC Common Minor Fault Occurrence
Cause and correction	Assumed cause		Correction		Prevention
	Instruction input parameter exceeded the valid range of the input variable.		Correct the parameter so that the valid range of the input variable is not exceeded for the relevant instruction.		Set the input parameter to the instruction so that the valid range of the input variable is not exceeded.
Attached information	None				
Precautions/Remarks	None				

Event name	Master Travel Distance Specification Out of Range		Event code	54820000 hex	
Meaning	The parameter specified for the <i>MasterDistance</i> input variable to a motion control instruction is out of range.				
Source	Motion Control Function Module		Source details	Axis	Detection timing At instruction execution
Error attributes	Level	Minor fault	Recovery	Error reset	Log category System
Effects	User program	Continues.	Operation	Operation is not possible for relevant slave axis. Relevant slave axis decelerates to a stop if it is in motion.	
System-defined variables	Variable		Data type		Name
	_MC_AX[*].MFaultLvl.Active		BOOL		Axis Minor Fault Occurrence
Cause and correction	Assumed cause		Correction		Prevention
	Instruction input parameter exceeded the valid range of the input variable.		Correct the parameter so that the valid range of the input variable is not exceeded for the relevant instruction.		Set the input parameter to the instruction so that the valid range of the input variable is not exceeded.
Attached information	None				
Precautions/Remarks	None				

Event name	Master Distance in Acceleration Specification Out of Range		Event code	54830000 hex		
Meaning	The parameter specified for the <i>MasterDistanceACC</i> input variable to a motion control instruction is out of range.					
Source	Motion Control Function Module		Source details	Axis	Detection timing	At instruction execution
Error attributes	Level	Minor fault	Recovery	Error reset	Log category	System
Effects	User program	Continues.	Operation	Operation is not possible for relevant slave axis. Relevant slave axis decelerates to a stop if it is in motion.		
System-defined variables	Variable	Data type		Name		
	_MC_AX[*].MFAultLvl.Active	BOOL		Axis Minor Fault Occurrence		
Cause and correction	Assumed cause		Correction		Prevention	
	Instruction input parameter exceeded the valid range of the input variable.		Correct the parameter so that the valid range of the input variable is not exceeded for the relevant instruction.		Set the input parameter to the instruction so that the valid range of the input variable is not exceeded.	
Attached information	None					
Precautions/Remarks	None					

Event name	Master Distance in Deceleration Specification Out of Range		Event code	54840000 hex		
Meaning	The parameter specified for the <i>MasterDistanceDEC</i> input variable to a motion control instruction is out of range.					
Source	Motion Control Function Module		Source details	Axis	Detection timing	At instruction execution
Error attributes	Level	Minor fault	Recovery	Error reset	Log category	System
Effects	User program	Continues.	Operation	Operation is not possible for relevant slave axis. Relevant slave axis decelerates to a stop if it is in motion.		
System-defined variables	Variable	Data type		Name		
	_MC_AX[*].MFAultLvl.Active	BOOL		Axis Minor Fault Occurrence		
Cause and correction	Assumed cause		Correction		Prevention	
	Instruction input parameter exceeded the valid range of the input variable.		Correct the parameter so that the valid range of the input variable is not exceeded for the relevant instruction.		Set the input parameter to the instruction so that the valid range of the input variable is not exceeded.	
Attached information	None					
Precautions/Remarks	None					

Event name	Execution Mode Selection Out of Range		Event code	54870000 hex		
Meaning	The parameter specified for the <i>ExecutionMode</i> input variable to a motion control instruction is out of range.					
Source	Motion Control Function Module		Source details	Axis	Detection timing	At instruction execution
Error attributes	Level	Minor fault	Recovery	Error reset	Log category	System
Effects	User program	Continues.	Operation	Operation is not possible for relevant axis. Relevant axis decelerates to a stop if it is in motion.		
System-defined variables	Variable		Data type		Name	
	_MC_AX[*].MFAultLvl.Active		BOOL		Axis Minor Fault Occurrence	
Cause and correction	Assumed cause		Correction		Prevention	
	Instruction input parameter exceeded the valid range of the input variable.		Correct the parameter so that the valid range of the input variable is not exceeded for the relevant instruction.		Set the input parameter to the instruction so that the valid range of the input variable is not exceeded.	
Attached information	None					
Precautions/Remarks	None					

Event name	Permitted Following Error Out of Range		Event code	54880000 hex		
Meaning	The parameter specified for the <i>PermittedDeviation</i> input variable to a motion control instruction is out of range.					
Source	Motion Control Function Module		Source details	MC Common	Detection timing	At instruction execution
Error attributes	Level	Minor fault	Recovery	Error reset	Log category	System
Effects	User program	Continues.	Operation	The instruction is not executed.		
System-defined variables	Variable		Data type		Name	
	_MC_COM.MFAultLvl.Active		BOOL		MC Common Minor Fault Occurrence	
Cause and correction	Assumed cause		Correction		Prevention	
	Instruction input parameter exceeded the valid range of the input variable.		Correct the parameter so that the valid range of the input variable is not exceeded for the relevant instruction.		Set the input parameter to the instruction so that the valid range of the input variable is not exceeded.	
Attached information	None					
Precautions/Remarks	None					

Event name	Border Point/Center Position/Radius Specification Out of Range		Event code	54890000 hex		
Meaning	The parameter specified for the <i>AuxPoint</i> input variable to a motion control instruction is out of range.					
Source	Motion Control Function Module		Source details	Axes group	Detection timing	At instruction execution
Error attributes	Level	Minor fault	Recovery	Error reset	Log category	System
Effects	User program	Continues.	Operation	Operation is not possible for relevant axes group. Relevant axes group decelerates to a stop if it is in motion.		
System-defined variables	Variable	Data type		Name		
	_MC_GRP[*].MFAultLvl.Active	BOOL		Axes Group Minor Fault Occurrence		
Cause and correction	Assumed cause		Correction		Prevention	
	The value of <i>AuxPoint</i> exceeded signed 40-bit data when converted to pulses for the border point or center specification method.		Correct the parameter so that the valid range of the input variable is not exceeded for the relevant instruction.		Set the input parameter to the instruction so that the valid range of the input variable is not exceeded.	
	For a radius specifications, the absolute value of <i>AuxPoint[0]</i> exceeded 40-bit data when it is converted to pulses.					
Attached information	None					
Precautions/Remarks	None					

Event name	End Point Specification Out of Range		Event code	548A0000 hex		
Meaning	The parameter specified for the <i>EndPoint</i> input variable to a motion control instruction is out of range.					
Source	Motion Control Function Module		Source details	Axes group	Detection timing	At instruction execution
Error attributes	Level	Minor fault	Recovery	Error reset	Log category	System
Effects	User program	Continues.	Operation	Operation is not possible for relevant axes group. Relevant axes group decelerates to a stop if it is in motion.		
System-defined variables	Variable	Data type		Name		
	_MC_GRP[*].MFAultLvl.Active	BOOL		Axes Group Minor Fault Occurrence		
Cause and correction	Assumed cause		Correction		Prevention	
	The instruction input parameter exceeded the range of signed 40-bit data when it is converted to pulses.		Correct the parameter so that the valid range of the input variable is not exceeded for the relevant instruction.		Set the input parameter to the instruction so that the valid range of the input variable is not exceeded.	
Attached information	None					
Precautions/Remarks	None					

3 Error Descriptions and Corrections

Event name	Slave Travel Distance Specification Out of Range		Event code	548B0000 hex		
Meaning	The parameter specified for the <i>SlaveDistance</i> input variable to a motion control instruction is out of range.					
Source	Motion Control Function Module		Source details	Axis	Detection timing	At instruction execution
Error attributes	Level	Minor fault	Recovery	Error reset	Log category	System
Effects	User program	Continues.	Operation	Operation is not possible for relevant slave axis. Relevant slave axis decelerates to a stop if it is in motion.		
System-defined variables	Variable		Data type		Name	
	_MC_AX[*].MFAultLvl.Active		BOOL		Axis Minor Fault Occurrence	
Cause and correction	Assumed cause		Correction		Prevention	
	The instruction input parameter exceeded the range of 40-bit data when it is converted to pulses.		Correct the parameter so that the valid range of the input variable is not exceeded for the relevant instruction.		Set the input parameter to the instruction so that the valid range of the input variable is not exceeded.	
Attached information	None					
Precautions/Remarks	None					

Event name	Phase Shift Amount Out of Range		Event code	548C0000 hex		
Meaning	The parameter specified for the <i>PhaseShift</i> input variable to a motion control instruction is out of range.					
Source	Motion Control Function Module		Source details	Axis	Detection timing	At instruction execution
Error attributes	Level	Minor fault	Recovery	Error reset	Log category	System
Effects	User program	Continues.	Operation	Operation is not possible for relevant slave axis. Relevant slave axis decelerates to a stop if it is in motion.		
System-defined variables	Variable		Data type		Name	
	_MC_AX[*].MFAultLvl.Active		BOOL		Axis Minor Fault Occurrence	
Cause and correction	Assumed cause		Correction		Prevention	
	The absolute value of the instruction input parameter exceeded the range of 40-bit data when it is converted to pulses.		Correct the parameter so that the valid range of the input variable is not exceeded for the relevant instruction.		Set the input parameter to the instruction so that the valid range of the input variable is not exceeded.	
Attached information	None					
Precautions/Remarks	None					

Event name	Feeding Distance Out of Range			Event code	548D0000 hex	
Meaning	The parameter specified for the <i>FeedDistance</i> input variable to a motion control instruction is out of range.					
Source	Motion Control Function Module		Source details	Axis	Detection timing	At instruction execution
Error attributes	Level	Minor fault	Recovery	Error reset	Log category	System
Effects	User program	Continues.	Operation	Operation is not possible for relevant axis. Relevant axis decelerates to a stop if it is in motion.		
System-defined variables	Variable		Data type		Name	
	_MC_AX[*].MFAultLvl.Active		BOOL		Axis Minor Fault Occurrence	
Cause and correction	Assumed cause		Correction		Prevention	
	The absolute value of the instruction input parameter exceeded the range of 40-bit data when it is converted to pulses.		Correct the parameter so that the valid range of the input variable is not exceeded for the relevant instruction.		Set the input parameter to the instruction so that the valid range of the input variable is not exceeded.	
Attached information	None					
Precautions/Remarks	None					

Event name	Auxiliary and Slave Defined as Same Axis			Event code	548E0000 hex	
Meaning	The same axis is specified for the <i>Auxiliary</i> and <i>Slave</i> input variables to a motion control instruction.					
Source	Motion Control Function Module		Source details	Axis	Detection timing	At instruction execution
Error attributes	Level	Minor fault	Recovery	Error reset	Log category	System
Effects	User program	Continues.	Operation	Operation is not possible for relevant slave axis. Relevant slave axis decelerates to a stop if it is in motion.		
System-defined variables	Variable		Data type		Name	
	_MC_AX[*].MFAultLvl.Active		BOOL		Axis Minor Fault Occurrence	
Cause and correction	Assumed cause		Correction		Prevention	
	The parameter was the same for the <i>Auxiliary</i> and <i>Slave</i> input variables to the instruction.		Correct the parameters so that different axes are specified for the <i>Auxiliary</i> and <i>Slave</i> input variables to the instruction.		Specify different axes for the auxiliary axis and slave axis for a motion control instruction.	
Attached information	None					
Precautions/Remarks	None					

Event name	Relative Position Selection Out of Range		Event code	548F0000 hex		
Meaning	The parameter specified for the <i>Relative</i> input variable to a motion control instruction is out of range.					
Source	Motion Control Function Module		Source details	Axis	Detection timing	At instruction execution
Error attributes	Level	Minor fault	Recovery	Error reset	Log category	System
Effects	User program	Continues.	Operation	Operation is not possible for relevant axis. Relevant axis decelerates to a stop if it is in motion.		
System-defined variables	Variable		Data type		Name	
	_MC_AX[*].MFAultLvl.Active		BOOL		Axis Minor Fault Occurrence	
Cause and correction	Assumed cause		Correction		Prevention	
	Instruction input parameter exceeded the valid range of the input variable.		Correct the parameter so that the valid range of the input variable is not exceeded for the relevant instruction.		Set the input parameter to the instruction so that the valid range of the input variable is not exceeded.	
Attached information	None					
Precautions/Remarks	None					

Event name	Cam Transition Specification Out of Range		Event code	54900000 hex		
Meaning	The parameter specified for the <i>CamTransition</i> input variable to a motion control instruction is out of range.					
Source	Motion Control Function Module		Source details	Axis	Detection timing	At instruction execution
Error attributes	Level	Minor fault	Recovery	Error reset	Log category	System
Effects	User program	Continues.	Operation	Operation is not possible for relevant slave axis. Relevant slave axis decelerates to a stop if it is in motion.		
System-defined variables	Variable		Data type		Name	
	_MC_AX[*].MFAultLvl.Active		BOOL		Axis Minor Fault Occurrence	
Cause and correction	Assumed cause		Correction		Prevention	
	Instruction input parameter exceeded the valid range of the input variable.		Correct the parameter so that the valid range of the input variable is not exceeded for the relevant instruction.		Set the input parameter to the instruction so that the valid range of the input variable is not exceeded.	
Attached information	None					
Precautions/Remarks	None					

Event name	Synchronized Control End Mode Selection Out of Range		Event code	54910000 hex		
Meaning	The parameter specified for the <i>OutMode</i> input variable to a motion control instruction is out of range.					
Source	Motion Control Function Module		Source details	Axis	Detection timing	At instruction execution
Error attributes	Level	Minor fault	Recovery	Error reset	Log category	System
Effects	User program	Continues.	Operation	Operation is not possible for relevant slave axis. Relevant slave axis decelerates to a stop if it is in motion.		
System-defined variables	Variable	Data type		Name		
	<code>_MC_AX[*].MFAultLvl.Active</code>	BOOL		Axis Minor Fault Occurrence		
Cause and correction	Assumed cause		Correction		Prevention	
	Instruction input parameter exceeded the valid range of the input variable.		Correct the parameter so that the valid range of the input variable is not exceeded for the relevant instruction.		Set the input parameter to the instruction so that the valid range of the input variable is not exceeded.	
Attached information	None					
Precautions/Remarks	None					

Event name	Enable External Latch Instruction Execution Disabled		Event code	54920000 hex		
Meaning	<code>_mclImmediateStop (Immediate Stop)</code> was specified for the <i>StopMode</i> input variable when the MC_TouchProbe (Enable External Latch) instruction was executed in Drive Mode for an encoder axis.					
Source	Motion Control Function Module		Source details	Axis	Detection timing	At instruction execution
Error attributes	Level	Minor fault	Recovery	Error reset	Log category	System
Effects	User program	Continues.	Operation	Operation is not possible for relevant axis. Relevant axis decelerates to a stop if it is in motion.		
System-defined variables	Variable	Data type		Name		
	<code>_MC_AX[*].MFAultLvl.Active</code>	BOOL		Axis Minor Fault Occurrence		
Cause and correction	Assumed cause		Correction		Prevention	
	<code>_mclImmediateStop (Immediate Stop)</code> was specified for the <i>StopMode</i> input variable when the MC_TouchProbe (Enable External Latch) instruction was executed in Drive Mode for an encoder axis.		Correct the program so that <code>_mclImmediateStop (Immediate Stop)</code> is not specified for <i>StopMode</i> for the encoder axis.		If you specify <code>_mclImmediateStop (Immediate Stop)</code> and use Drive Mode, execute the MC_TouchProbe (Enable External Latch) instruction only for a servo axis.	
Attached information	None					
Precautions/Remarks	None					

Event name	Master Axis Offset Out of Range			Event code	54930000 hex	
Meaning	The parameter specified for the <i>MasterOffset</i> input variable to a motion control instruction is out of range.					
Source	Motion Control Function Module		Source details	Axis	Detection timing	At instruction execution
Error attributes	Level	Minor fault	Recovery	Error reset	Log category	System
Effects	User program	Continues.	Operation	Operation is not possible for relevant slave axis. Relevant slave axis decelerates to a stop if it is in motion.		
System-defined variables	Variable		Data type		Name	
	_MC_AX[*].MFAultLvl.Active		BOOL		Axis Minor Fault Occurrence	
Cause and correction	Assumed cause		Correction		Prevention	
	The instruction input parameter exceeded the range of signed 40-bit data when it is converted to pulses.		Correct the parameter so that the valid range of the input variable is not exceeded for the relevant instruction.		Set the input parameter to the instruction so that the valid range of the input variable is not exceeded.	
Attached information	None					
Precautions/Remarks	None					

Event name	Slave Axis Offset Out of Range			Event code	54940000 hex	
Meaning	The parameter specified for the <i>SlaveOffset</i> input variable to a motion control instruction is out of range.					
Source	Motion Control Function Module		Source details	Axis	Detection timing	At instruction execution
Error attributes	Level	Minor fault	Recovery	Error reset	Log category	System
Effects	User program	Continues.	Operation	Operation is not possible for relevant slave axis. Relevant slave axis decelerates to a stop if it is in motion.		
System-defined variables	Variable		Data type		Name	
	_MC_AX[*].MFAultLvl.Active		BOOL		Axis Minor Fault Occurrence	
Cause and correction	Assumed cause		Correction		Prevention	
	The instruction input parameter exceeded the range of signed 40-bit data when it is converted to pulses.		Correct the parameter so that the valid range of the input variable is not exceeded for the relevant instruction.		Set the input parameter to the instruction so that the valid range of the input variable is not exceeded.	
Attached information	None					
Precautions/Remarks	None					

Event name	Command Current Position Count Selection Out of Range		Event code	54950000 hex		
Meaning	The parameter specified for the <i>CmdPosMode</i> input variable to a motion control instruction is out of range.					
Source	Motion Control Function Module		Source details	Axis	Detection timing	At instruction execution
Error attributes	Level	Minor fault	Recovery	Error reset	Log category	System
Effects	User program	Continues.	Operation	Operation is not possible for relevant axis. Relevant axis decelerates to a stop if it is in motion.		
System-defined variables	Variable		Data type		Name	
	_MC_AX[*].MFaultLvl.Active		BOOL		Axis Minor Fault Occurrence	
Cause and correction	Assumed cause		Correction		Prevention	
	Instruction input parameter exceeded the valid range of the input variable.		Correct the parameter so that the valid range of the input variable is not exceeded for the relevant instruction.		Set the input parameter to the instruction so that the valid range of the input variable is not exceeded.	
Attached information	None					
Precautions/Remarks	None					

Event name	Master Axis Gear Ratio Numerator Out of Range		Event code	54960000 hex		
Meaning	The parameter specified for the <i>RatioNumeratorMaster</i> input variable to a motion control instruction is out of range.					
Source	Motion Control Function Module		Source details	Axis	Detection timing	At instruction execution
Error attributes	Level	Minor fault	Recovery	Error reset	Log category	System
Effects	User program	Continues.	Operation	Operation is not possible for relevant slave axis. Relevant slave axis decelerates to a stop if it is in motion.		
System-defined variables	Variable		Data type		Name	
	_MC_AX[*].MFaultLvl.Active		BOOL		Axis Minor Fault Occurrence	
Cause and correction	Assumed cause		Correction		Prevention	
	Instruction input parameter exceeded the valid range of the input variable.		Correct the parameter so that the valid range of the input variable is not exceeded for the relevant instruction.		Set the input parameter to the instruction so that the valid range of the input variable is not exceeded.	
Attached information	None					
Precautions/Remarks	None					

3 Error Descriptions and Corrections

Event name	Master Axis Gear Ratio Denominator Out of Range		Event code	54970000 hex		
Meaning	The parameter specified for the <i>RatioDenominatorMaster</i> input variable to a motion control instruction is out of range.					
Source	Motion Control Function Module		Source details	Axis	Detection timing	At instruction execution
Error attributes	Level	Minor fault	Recovery	Error reset	Log category	System
Effects	User program	Continues.	Operation	Operation is not possible for relevant slave axis. Relevant slave axis decelerates to a stop if it is in motion.		
System-defined variables	Variable		Data type		Name	
	_MC_AX[*].MFaultLvl.Active		BOOL		Axis Minor Fault Occurrence	
Cause and correction	Assumed cause		Correction		Prevention	
	Instruction input parameter exceeded the valid range of the input variable.		Correct the parameter so that the valid range of the input variable is not exceeded for the relevant instruction.		Set the input parameter to the instruction so that the valid range of the input variable is not exceeded.	
Attached information	None					
Precautions/Remarks	None					

Event name	Auxiliary Axis Gear Ratio Numerator Out of Range		Event code	54980000 hex		
Meaning	The parameter specified for the <i>RatioNumeratorAuxiliary</i> input variable to a motion control instruction is out of range.					
Source	Motion Control Function Module		Source details	Axis	Detection timing	At instruction execution
Error attributes	Level	Minor fault	Recovery	Error reset	Log category	System
Effects	User program	Continues.	Operation	Operation is not possible for relevant slave axis. Relevant slave axis decelerates to a stop if it is in motion.		
System-defined variables	Variable		Data type		Name	
	_MC_AX[*].MFaultLvl.Active		BOOL		Axis Minor Fault Occurrence	
Cause and correction	Assumed cause		Correction		Prevention	
	Instruction input parameter exceeded the valid range of the input variable.		Correct the parameter so that the valid range of the input variable is not exceeded for the relevant instruction.		Set the input parameter to the instruction so that the valid range of the input variable is not exceeded.	
Attached information	None					
Precautions/Remarks	None					

Event name	Auxiliary Axis Gear Ratio Denominator Out of Range		Event code	54990000 hex		
Meaning	The parameter specified for the <i>RatioDenominatorAuxiliary</i> input variable to a motion control instruction is out of range.					
Source	Motion Control Function Module		Source details	Axis	Detection timing	At instruction execution
Error attributes	Level	Minor fault	Recovery	Error reset	Log category	System
Effects	User program	Continues.	Operation	Operation is not possible for relevant slave axis. Relevant slave axis decelerates to a stop if it is in motion.		
System-defined variables	Variable		Data type		Name	
	_MC_AX[*].MFAultLvl.Active		BOOL		Axis Minor Fault Occurrence	
Cause and correction	Assumed cause		Correction		Prevention	
	Instruction input parameter exceeded the valid range of the input variable.		Correct the parameter so that the valid range of the input variable is not exceeded for the relevant instruction.		Set the input parameter to the instruction so that the valid range of the input variable is not exceeded.	
Attached information	None					
Precautions/Remarks	None					

Event name	Master Axis Position Type Selection Out of Range		Event code	549A0000 hex		
Meaning	The parameter specified for the <i>ReferenceTypeMaster</i> input variable to a motion control instruction is out of range.					
Source	Motion Control Function Module		Source details	Axis	Detection timing	At instruction execution
Error attributes	Level	Minor fault	Recovery	Error reset	Log category	System
Effects	User program	Continues.	Operation	Operation is not possible for relevant slave axis. Relevant slave axis decelerates to a stop if it is in motion.		
System-defined variables	Variable		Data type		Name	
	_MC_AX[*].MFAultLvl.Active		BOOL		Axis Minor Fault Occurrence	
Cause and correction	Assumed cause		Correction		Prevention	
	Instruction input parameter exceeded the valid range of the input variable.		Correct the parameter so that the valid range of the input variable is not exceeded for the relevant instruction.		Set the input parameter to the instruction so that the valid range of the input variable is not exceeded.	
Attached information	None					
Precautions/Remarks	None					

3 Error Descriptions and Corrections

Event name	Auxiliary Axis Position Type Selection Out of Range		Event code	549B0000 hex		
Meaning	The parameter specified for the <i>ReferenceTypeAuxiliary</i> input variable to a motion control instruction is out of range.					
Source	Motion Control Function Module		Source details	Axis	Detection timing	At instruction execution
Error attributes	Level	Minor fault	Recovery	Error reset	Log category	System
Effects	User program	Continues.	Operation	Operation is not possible for relevant slave axis. Relevant slave axis decelerates to a stop if it is in motion.		
System-defined variables	Variable		Data type		Name	
	_MC_AX[*].MFAultLvl.Active		BOOL		Axis Minor Fault Occurrence	
Cause and correction	Assumed cause		Correction		Prevention	
	Instruction input parameter exceeded the valid range of the input variable.		Correct the parameter so that the valid range of the input variable is not exceeded for the relevant instruction.		Set the input parameter to the instruction so that the valid range of the input variable is not exceeded.	
Attached information	None					
Precautions/Remarks	None					

Event name	Target Position Ring Counter Out of Range		Event code	549C0000 hex		
Meaning	Operation is not possible because the target position is out of range for the ring counter of the executed instruction.					
Source	Motion Control Function Module		Source details	Axis	Detection timing	At instruction execution
Error attributes	Level	Minor fault	Recovery	Error reset	Log category	System
Effects	User program	Continues.	Operation	Operation is not possible for relevant axis. Relevant axis decelerates to a stop if it is in motion.		
System-defined variables	Variable		Data type		Name	
	_MC_AX[*].MFAultLvl.Active		BOOL		Axis Minor Fault Occurrence	
Cause and correction	Assumed cause		Correction		Prevention	
	High-speed homing was executed when 0 was not included in the ring counter.		High-speed homing cannot be executed when the ring counter range does not include 0. Correct the program so that high-speed homing is not performed. Or change the settings so that the ring counter range includes 0.		High-speed homing cannot be executed when the ring counter range does not include 0. Write the program so that high-speed homing is not performed. Or make the settings so that the ring counter range includes 0.	
Attached information	None					
Precautions/Remarks	None					

Event name	Axes Group Composition Axis Setting Out of Range		Event code	549D0000 hex*1	
Meaning	The parameter specified for the <i>Axes</i> input variable to a motion control instruction is out of range.				
Source	Motion Control Function Module		Source details	Axes group	Detection timing At instruction execution
Error attributes	Level	Minor fault	Recovery	Error reset	Log category System
Effects	User program	Continues.	Operation	Operation is not possible for relevant axes group. Relevant axes group decelerates to a stop if the axes are in motion.	
System-defined variables	Variable	Data type		Name	
	_MC_GRP[*].MFAultLvl.Active	BOOL		Axes Group Minor Fault Occurrence	
Cause and correction	Assumed cause		Correction		Prevention
	Instruction input parameter exceeded the valid range of the input variable.		Correct the parameter so that the valid range of the input variable is not exceeded for the relevant instruction.		Set the input parameter to the instruction so that the valid range of the input variable is not exceeded.
	The composition axes in the axes group are not assigned to the same task.		Assign all of the axes that are specified for the <i>Axes</i> input variable to the instruction to the same task.		Specify axes that are assigned to the same task for all of the composition axes in an axes group.
Attached information	Attached Information 1: Error Details 01 hex: There is a type specification error. 02 hex: The number of elements in the array is lower than the number of composition axes. 03 hex: The same axis number is specified twice, the axis type of the specified axis number is not supported, or the specified axis number is out of range. 04 hex: The axis with the specified axis number cannot be set as the composition axis because it is a single-axis position control axis.				
Precautions/Remarks	None				

*1. This event code occurs for a CPU Unit with unit version 1.01 or later.

Event name	Axis Use Setting Out of Range		Event code	549E0000 hex*1	
Meaning	The parameter specified for the <i>AxisUse</i> input variable to a motion control instruction is out of range.				
Source	Motion Control Function Module		Source details	MC common or axis	Detection timing At instruction execution
Error attributes	Level	Minor fault	Recovery	Error reset	Log category System
Effects	User program	Continues.	Operation	Not affected.	
System-defined variables	Variable	Data type		Name	
	_MC_COM.MFAultLvl.Active	BOOL		MC Common Minor Fault Occurrence	
	_MC_AX[*].MFAultLvl.Active	BOOL		Axis Minor Fault Occurrence	
Cause and correction	Assumed cause		Correction		Prevention
	Instruction input parameter exceeded the valid range of the input variable.		Correct the parameter so that the valid range of the input variable is not exceeded for the relevant instruction.		Set the input parameter to the instruction so that the valid range of the input variable is not exceeded.
Attached information	None				
Precautions/Remarks	If an error occurs in executing an instruction for a used axis, an axis error will occur. If an error occurs in executing an instruction for an unused axis, an MC common error will occur.				

*1. This event code occurs for a CPU Unit with unit version 1.04 or later.

Event name	Homing Parameter Setting Out of Range		Event code	57000000 hex ^{*1}	
Meaning	The parameter specified for the <i>HomingParameter</i> input variable to a motion control instruction is out of range.				
Source	Motion Control Function Module		Source details	Axis	Detection timing
					At instruction execution
Error attributes	Level	Minor fault	Recovery	Error reset	Log category
					System
Effects	User program	Continues.	Operation	Not affected.	
System-defined variables	Variable	Data type		Name	
	_MC_COM.MFaultLvl.Active	BOOL		MC Common Minor Fault Occurrence	
Cause and correction	Assumed cause		Correction		Prevention
	Instruction input parameter exceeded the valid range of the input variable.		Correct the parameter so that the valid range of the input variable is not exceeded for the relevant instruction.		Set the input parameter to the instruction so that the valid range of the input variable is not exceeded.
Attached information	<p>Attached Information 1: Error Details</p> <p>1: Homing Method out of range, 2: Home Input Signal out of range, 3: Homing Start Direction out of range, 4: Home Input Detection Direction out of range, 5: Operation Selection at Positive Limit Input out of range, 6: Operation Selection at Negative Limit Input out of range, 7: Homing Velocity out of range, 8: Homing Approach Velocity out of range, 9: Homing Acceleration out of range, 10: Homing Deceleration out of range, 11: Homing Jerk out of range, 12: Home Input Mask Distance out of range, 13: Absolute Encoder Home Offset out of range, 14: Homing Holding Time out of range, 15: Homing Compensation Value out of range, 16: Homing Compensation Velocity out of range, 100: Home Input Mask Distance exceeded 40-bit range when converted to pulses, 101: Home Input Mask Distance exceeded modulo length, 102: Homing Compensation Value exceeded 40-bit range when converted to pulses, 103: Homing Compensation Value exceeded modulo length, 104: Home Offset exceeded 40-bit range when converted to pulses, 105: Home Offset exceeded modulo range, 106: Homing Velocity exceeded maximum velocity, 107: Homing Approach Velocity exceeded maximum velocity, 108: Homing Approach Velocity was not less than or equal to Homing Velocity, 109: Homing Compensation Velocity is not less than or equal to Maximum Velocity, 110: Homing Acceleration exceeded maximum acceleration rate, 111: Homing Deceleration exceeded maximum deceleration rate</p>				
Precautions/Remarks	None				

*1. This event code occurs for a CPU Unit with unit version 1.03 or later.

Event name	Axis Use Change Error		Event code	57020000 hex*1	
Meaning	The MC_ChangeAxisUse (Change Axis Use) instruction was executed when the axis was not stopped or when the command velocity of the axis was saturated.				
Source	Motion Control Function Module		Source details	Axis	Detection timing At instruction execution
Error attributes	Level	Minor fault	Recovery	Error reset	Log category System
Effects	User program	Continues.	Operation	Not affected.	
System-defined variables	Variable	Data type		Name	
	_MC_AX[*].MFAultLvl.Active	BOOL		Axis Minor Fault Occurrence	
Cause and correction	Assumed cause		Correction		Prevention
	The MC_ChangeAxisUse (Change Axis Use) instruction was executed when the axis was not stopped or when the command velocity of the axis was saturated.		Reset the error and execute the MC_ChangeAxisUse (Change Axis Use) instruction when the axis is stopped or when the command velocity of the axis is not saturated. An axis is stopped if <i>Status.Disabled</i> or <i>Status.Standstill</i> is TRUE in the Axis Variable. The command velocity for an axis is saturated if <i>Details.VelLimit</i> is TRUE in the Axis Variable.		Execute the MC_ChangeAxisUse (Change Axis Use) instruction when the axis is stopped and the command velocity is not saturated.
Attached information	None				
Precautions/Remarks	None				

*1. This event code occurs for a CPU Unit with unit version 1.04 or later.

Event name	Cannot Change Axis Use		Event code	57030000 hex ^{*1}		
Meaning	The MC_ChangeAxisUse (Change Axis Use) instruction was executed in a way that would cause the maximum number of used real axes or the maximum number of used motion control servo axes to be exceeded.					
Source	Motion Control Function Module		Source details	MC Common	Detection timing	At instruction execution
Error attributes	Level	Minor fault	Recovery	Error reset	Log category	System
Effects	User program	Continues.	Operation	Not affected.		
System-defined variables	Variable	Data type		Name		
	_MC_COM.MFaultLvl.Active	BOOL		MC Common Minor Fault Occurrence		
Cause and correction	Assumed cause		Correction		Prevention	
	The MC_ChangeAxisUse (Change Axis Use) instruction was executed in a way that would cause the maximum number of used real axes to be exceeded.		Correct the program so that the maximum number of real axes used by the CPU Unit is not exceeded.		Write the program so that the maximum number of real axes used by the CPU Unit is not exceeded.	
	The MC_ChangeAxisUse (Change Axis Use) instruction was executed in a way that would cause the maximum number of used motion control servo axes to be exceeded.		Correct the program so that the maximum number of used motion control servo axes that can be used by the CPU Unit is not exceeded.		Write the program so that the maximum number of used motion control servo axes that can be used by the CPU Unit is not exceeded.	
Attached information	Attached Information 1: Cause of the Error <ul style="list-style-type: none"> • 1: Maximum number of used real axes exceeded • 2: Maximum number of used motion control servo axes exceeded 					
Precautions/Remarks	None					

*1. This event code occurs for a CPU Unit with unit version 1.06 or later.

Event name	Motion Control Parameter Setting Error When Changing Axis Use		Event code	57200000 hex*1		
Meaning	The motion control parameter settings for the axis that was changed to a used axis are incorrect.					
Source	Motion Control Function Module		Source details	MC Common	Detection timing	At instruction execution
Error attributes	Level	Minor fault	Recovery	Error reset	Log category	System
Effects	User program	Continues.	Operation	Not affected.		
System-defined variables	Variable		Data type		Name	
	_MC_COM.MFaultLvl.Active		BOOL		MC Common Minor Fault Occurrence	
Cause and correction	Assumed cause		Correction		Prevention	
	The MC_ChangeAxisUse (Change Axis Use) instruction was used to change an unused axis to a used axis, but the motion control parameter settings of the axis are not correct.		Use the Sysmac Studio to change the Axis Use of the axis where the error occurred to a Used Axis , and then check and correct the error location. If an error does not occur, change the setting to an Unused Axis and then download the settings again.		Make sure that operation is correct when the axis is set to a Used Axis and then download the settings with it set to an Unused Axis .	
	The power supply was interrupted while a download of the motion control parameter settings was in progress.		Download the MC parameters from the Sysmac Studio.		Do not interrupt the power supply while saving the parameter settings.	
	The non-volatile memory is faulty or the life of the non-volatile memory has been exceeded.		If this error remains even after making the above corrections, replace the CPU Unit.		None	
Attached information	None					
Precautions/Remarks	None					

*1. This event code occurs for a CPU Unit with unit version 1.04 or later.

Event name	Required Process Data Object Not Set When Changing Axis Use		Event code	57210000 hex ^{*1}		
Meaning	The objects that are required for the axis type of the axis that was changed to a used axis are not set.					
Source	Motion Control Function Module		Source details	MC Common	Detection timing	At instruction execution
Error attributes	Level	Minor fault	Recovery	Error reset	Log category	System
Effects	User program	Continues.	Operation	Not affected.		
System-defined variables	Variable		Data type		Name	
	_MC_COM.MFaultLvl.Active		BOOL		MC Common Minor Fault Occurrence	
Cause and correction	Assumed cause		Correction		Prevention	
	The objects that are required for the axis type of the axis that was changed to a used axis are not set in the PDO map settings.		Edit the PDO map settings on the Sysmac Studio and set the objects that are required for the axis where the error occurred. Refer to PDO Mapping on page 2-35 for the required objects.		Make sure that operation is correct when the axis is set to a Used Axis and then download the settings with it set to an Unused Axis .	
	The power supply was interrupted while a download of the motion control parameter settings was in progress.		Download the MC parameters from the Sysmac Studio.		Do not interrupt the power supply while saving the parameter settings.	
	The non-volatile memory is faulty or the life of the non-volatile memory has been exceeded.		If this error remains even after making the above corrections, replace the CPU Unit.		None	
	The MC_ChangeAxisUse (Change Axis Use) instruction was executed for an axis that Axis Use is set to Unused axis (unchangeable to used axis) .		Correct the program so that the MC_ChangeAxisUse (Change Axis Use) instruction is not executed for an axis that Axis Use is set to Unused axis (unchangeable to used axis) .		Write the program so that the MC_ChangeAxisUse (Change Axis Use) instruction is not executed for an axis that Axis Use is set to Unused axis (unchangeable to used axis) .	
Attached information	None					
Precautions/Remarks	None					

*1. This event code occurs for a CPU Unit with unit version 1.04 or later.

Event name	Motion Control Instruction Multi-execution Disabled (Master Axis)		Event code	572F0000 hex*1		
Meaning	A <i>Master</i> in-out variable that cannot be changed during multi-execution of instructions was changed.					
Source	Motion Control Function Module		Source details	Axis	Detection timing	At multi-execution of instructions
Error attributes	Level	Minor fault	Recovery	Error reset	Log category	System
Effects	User program	Continues.	Operation	Not affected.		
System-defined variables	Variable	Data type		Name		
	_MC_AX[*].MFAultLvl.Active	BOOL		Axis Minor Fault Occurrence		
Cause and correction	Assumed cause		Correction		Prevention	
	A <i>Master</i> in-out variable that cannot be changed during multi-execution of instructions was changed.		Correct the program so that the value of the <i>Master</i> in-out variable is not changed during multi-execution of the relevant instructions.		Write the program so that the value of the <i>Master</i> in-out variable is not changed during multi-execution of the relevant instructions.	
Attached information	None					
Precautions/Remarks	None					

*1. This event code occurs for a CPU Unit with unit version 1.06 or later.

Event name	Motion Control Instruction Multi-execution Disabled (Position Type Selection)		Event code	57300000 hex*1		
Meaning	A <i>ReferenceType</i> in-out variable that cannot be changed during multi-execution of instructions was changed.					
Source	Motion Control Function Module		Source details	Axis	Detection timing	At multi-execution of instructions
Error attributes	Level	Minor fault	Recovery	Error reset	Log category	System
Effects	User program	Continues.	Operation	Not affected.		
System-defined variables	Variable	Data type		Name		
	_MC_AX[*].MFAultLvl.Active	BOOL		Axis Minor Fault Occurrence		
Cause and correction	Assumed cause		Correction		Prevention	
	A <i>ReferenceType</i> in-out variable that cannot be changed during multi-execution of instructions was changed.		Correct the program so that the value of the <i>ReferenceType</i> in-out variable is not changed during multi-execution of the relevant instructions.		Write the program so that the value of the <i>ReferenceType</i> in-out variable is not changed during multi-execution of the relevant instructions.	
Attached information	None					
Precautions/Remarks	None					

*1. This event code occurs for a CPU Unit with unit version 1.06 or later.

Event name	Cannot Write Axis Parameters		Event code	573A0000 hex*1		
Meaning	The instruction was executed for an axis that is not an unused axis.					
Source	Motion Control Function Module		Source details	MC Common	Detection timing	At instruction execution
Error attributes	Level	Minor fault	Recovery	Error reset	Log category	System
Effects	User program	Continues.	Operation	Not affected.		
System-defined variables	Variable		Data type		Name	
	_MC_COM.MFaultLvl.Active		BOOL		MC Common Minor Fault Occurrence	
Cause and correction	Assumed cause		Correction		Prevention	
	The instruction was executed for a used axis or an undefined axis.		Correct the program so that the MC_ChangeAxisUse (Change Axis Use) instruction is executed after the specified axis is changed to an unused axis.		Write the program so that the specified axis is an unused axis when the instruction is executed.	
Attached information	None					
Precautions/Remarks	None					

*1. This event code occurs for a CPU Unit with unit version 1.08 or later.

Event name	Axis Parameter Setting Out of Range		Event code	573B0000 hex*1	
Meaning	The parameter specified for the <i>AxisParameter</i> input variable to a motion control instruction is outside of the valid range.				
Source	Motion Control Function Module		Source details	MC Common	Detection timing At instruction execution
Error attributes	Level	Minor fault	Recovery	Error reset	Log category System
Effects	User program	Continues.	Operation	Not affected.	
System-defined variables	Variable		Data type		Name
	_MC_COM.MFaultLvl.Active		BOOL		MC Common Minor Fault Occurrence
Cause and correction	Assumed cause		Correction		Prevention
	The parameter specified for the <i>AxisParameter</i> input variable to the instruction is out of range for the input variable.		Correct the parameter so that the valid range of the input variable is not exceeded for the instruction. Confirm which parameter exceeded the range or what parameters are inconsistent in the attached information.		Set the input parameter to the instruction so that the valid range of the input variable is not exceeded. Refer to information on the MC_WriteAxisParameter (Write Axis Parameters) instruction for the valid ranges of the input variables.

<p>Attached information</p>	<p>Attached Information 1: Error Details</p> <ul style="list-style-type: none"> Range Check Detail Codes <p>0000 hex: Unit of Display out of range, 0001 hex: Command Pulse Count Per Motor Rotation out of range, 0002 hex: Work Travel Distance Per Motor Rotation out of range, 0003 hex: Work Travel Distance Per Rotation out of range, 0004 hex: Work Gear Ratio out of range, 0005 hex: Motor Gear Ratio out of range, 0100 hex: Maximum Velocity out of range, 0101 hex: Start Velocity out of range, 0102 hex: Maximum Jog Velocity out of range, 0103 hex: Maximum Acceleration out of range, 0104 hex: Maximum Deceleration out of range, 0105 hex: Acceleration/Deceleration Over out of range, 0106 hex: Operation Selection at Reversing out of range, 0107 hex: Velocity Warning Value out of range, 0108 hex: Acceleration Warning Value out of range, 0109 hex: Deceleration Warning Value out of range, 010A hex: Positive Torque Warning Value out of range, 010B hex: Negative Torque Warning Value out of range, 010C hex: In-position Range out of range, 010D hex: In-position Check Time out of range, 010E hex: Actual Velocity Filter Time Constant out of range, 010F hex: Zero Position Range out of range, 0200 hex: Immediate Stop Input Stop Method out of range, 0201 hex: Limit Input Stop Method out of range, 0202 hex: Drive Error Reset Monitoring Time out of range, 0203 hex: Maximum Positive Torque Limit out of range, 0204 hex: Maximum Negative Torque Limit out of range, 0300 hex: Software Limits out of range, 0301 hex: Positive Software Limit out of range, 0302 hex: Negative Software Limit out of range, 0303 hex: Following Error Over Limit Value out of range, 0304 hex: Following Error Warning Value out of range, 0400 hex: Count Mode out of range, 0401 hex: Modulo Maximum Position Setting Value out of range, 0402 hex: Modulo Minimum Position Setting Value out of range, 0500 hex: Homing Method out of range, 0501 hex: Home Input Signal out of range, 0502 hex: Homing Start Direction out of range, 0503 hex: Home Input Detection Direction out of range, 0504 hex: Operation Selection at Positive Limit Input out of range, 0505 hex: Operation Selection at Negative Limit Input out of range, 0506 hex: Homing Velocity out of range, 0507 hex: Homing Approach Velocity out of range, 0508 hex: Homing Acceleration out of range, 0509 hex: Homing Deceleration out of range, 050A hex: Homing Jerk out of range, 050B hex: Home Input Mask Distance out of range, 050C hex: Home Offset out of range, 050D hex: Homing Holding Time out of range, 050E hex: Homing Compensation Value out of range, 050F hex: Homing Compensation Velocity out of range</p> <ul style="list-style-type: none"> Consistency Check Detail Codes <p>1000 hex: The value found by the following calculation was out of the range between 0.000000001 and $2^{32}-1$: Work Travel Distance Per Rotation \times Work Gear Ratio/Motor Gear Ratio, 1001 hex: The value found by the following formula exceeded 40-bit range: Command Pulse Count Per Motor Rotation \times Motor Gear Ratio, 1100 hex: Maximum Velocity exceeded the upper limit*² when converted to pluses, 1101 hex: Start Velocity exceeded Maximum Velocity, 1102 hex: Maximum Jog Velocity exceeded Maximum Velocity, 1103 hex: In-position Range exceeded 40-bit range when converted to pulses, 1104 hex: Zero Position Range exceeded 40-bit range when converted to pulses, 1300 hex: Positive Software Limit exceeded 40-bit range when converted to pulses, 1301 hex: Negative Software Limit exceeded 40-bit range when converted to pulses, 1302 hex: Positive Software Limit was not greater than Negative Software Limit, 1303 hex: Following Error Over Value exceeded 40-bit range when converted to pulses, 1304 hex: Following Error Over Value was not greater than or equal to Following Error Warning Value, 1400 hex: Modulo Maximum Position Setting Value exceeded 40-bit range when converted to pulses, 1401 hex: Modulo Minimum Position Setting Value exceeded 40-bit range when converted to pulses, 1402 hex: Modulo Maximum Position Setting Value was not greater than Modulo Minimum Position Setting Value, 1403 hex: Absolute value of Modulo Maximum Position Setting Value minus Modulo Minimum Position Setting Value was not 2 or greater after conversion to pulses, 1500 hex: Homing Velocity exceeded Maximum Velocity, 1501 hex: Homing Approach Velocity was not less than or equal to Homing Velocity, 1502 hex: Homing Acceleration exceeded Maximum Acceleration, 1503 hex: Homing Deceleration exceeded Maximum Deceleration, 1504 hex: Home Input Mask Distance exceeded 40-bit range when converted to pulses, 1505 hex: Home Input Mask Distance exceeded modulo length, 1506 hex: Home Offset exceeded 40-bit range when converted to pulses, 1507 hex: Home Offset exceeded modulo length, 1508 hex: Absolute value of Homing Compensation Value exceeded 40-bit range when converted to pulses, 1509 hex: Absolute value of Homing Compensation Value exceeded modulo length, 150A hex: Homing Compensation Velocity was not less than or equal to Maximum Velocity</p> <p>Note Only one error code is given even if more than one error occurs. The range check detail codes are given priority over the consistency check detail codes.</p>
<p>Precautions/Remarks</p>	<p>None</p>

*1. This event code occurs for a CPU Unit with unit version 1.08 or later.

*2. The upper limit of the Maximum Velocity is 500 MHz for unit version 1.10 or earlier and 2,147,483,647 Hz for unit version 1.11 or later.

Event name	Cam Property Setting Out of Range		Event code	573C0000 hex*1		
Meaning	The parameter specified for the <i>CamProperty</i> input variable to a motion control instruction is outside of the valid range.					
Source	Motion Control Function Module		Source details	MC Common	Detection timing	At instruction execution
Error attributes	Level	Minor fault	Recovery	Error reset	Log category	System
Effects	User program	Continues.	Operation	Not affected.		
System-defined variables	Variable	Data type		Name		
	_MC_COM.MFaultLvl.Active	BOOL		MC Common Minor Fault Occurrence		
Cause and correction	Assumed cause		Correction		Prevention	
	The parameter specified for the <i>CamProperty</i> input variable to the instruction is out of range for the input variable.		Correct the parameter so that the valid range of the input variable is not exceeded for the instruction. Confirm which parameter exceeded the range in the attached information.		Set the input parameter to the instruction so that the valid range of the input variable is not exceeded.	
Attached information	Attached Information 1: Error Details <ul style="list-style-type: none"> • 0000 hex: Initial Velocity out of range • 0001 hex: Initial Acceleration out of range • 0002 hex: Cycle Time out of range 					
Precautions/Remarks	None					

*1. This event code occurs for a CPU Unit with unit version 1.08 or later.

Event name	Cam Node Setting Out of Range		Event code	573D0000 hex*1		
Meaning	The parameter specified for the <i>CamNodes</i> input variable to a motion control instruction is outside of the valid range.					
Source	Motion Control Function Module		Source details	MC Common	Detection timing	At instruction execution
Error attributes	Level	Minor fault	Recovery	Error reset	Log category	System
Effects	User program	Continues.	Operation	Not affected.		
System-defined variables	Variable	Data type		Name		
	_MC_COM.MFaultLvl.Active	BOOL		MC Common Minor Fault Occurrence		
Cause and correction	Assumed cause		Correction		Prevention	
	The parameter specified for the <i>CamNodes</i> input variable to the instruction is out of range for the input variable.		Correct the parameter so that the valid range of the input variable is not exceeded for the instruction. Confirm which parameter exceeded the range in the attached information.		Set the input parameter to the instruction so that the valid range of the input variable is not exceeded.	
Attached information	Attached Information 1: Error Details <ul style="list-style-type: none"> • 0000 hex: Master Axis Phase out of range • 0001 hex: Slave Axis Displacement out of range • 0002 hex: Curve Shape out of range • 0003 hex: Connecting Velocity out of range • 0004 hex: Connecting Acceleration out of range • 0005 hex: Phase Pitch out of range Attached Information 2: Element Number of Error Node Point					
Precautions/Remarks	None					

*1. This event code occurs for a CPU Unit with unit version 1.08 or later.

Event name	Incorrect Cam Node Type Specification		Event code	573E0000 hex ^{*1}		
Meaning	The parameter specified for the <i>CamNodes</i> input variable to a motion control instruction is not an <i>_sMC_CAM_NODE</i> array variable.					
Source	Motion Control Function Module		Source details	MC Common	Detection timing	At instruction execution
Error attributes	Level	Minor fault	Recovery	Error reset	Log category	System
Effects	User program	Continues.	Operation	Not affected.		
System-defined variables	Variable		Data type		Name	
	<i>_MC_COM.MFaultLvl.Active</i>		BOOL		MC Common Minor Fault Occurrence	
Cause and correction	Assumed cause		Correction		Prevention	
	The parameter specified for the <i>CamNodes</i> input variable to the instruction is not an <i>_sMC_CAM_NODE</i> array variable.		Correct the program to specify an <i>sMC_CAM_NODE</i> array variable for the input variable to the instruction.		Write the program to specify an <i>sMC_CAM_NODE</i> array variable for the input variable to the instruction.	
Attached information	None					
Precautions/Remarks	None					

*1. This event code occurs for a CPU Unit with unit version 1.08 or later.

Event name	Insufficient Nodes in Cam Table		Event code	573F0000 hex ^{*1}		
Meaning	The array variable of the parameter specified for the <i>CamNodes</i> input variable to a motion control instruction has a <i>Phase</i> value of 0 for element number 0.					
Source	Motion Control Function Module		Source details	MC Common	Detection timing	At instruction execution
Error attributes	Level	Minor fault	Recovery	Error reset	Log category	System
Effects	User program	Continues.	Operation	Not affected.		
System-defined variables	Variable		Data type		Name	
	<i>_MC_COM.MFaultLvl.Active</i>		BOOL		MC Common Minor Fault Occurrence	
Cause and correction	Assumed cause		Correction		Prevention	
	The array variable of the parameter specified for <i>CamNodes</i> input variable to the instruction has a <i>Phase</i> (master axis phase) value of 0 for element number 0.		Correct the program so that the value of <i>Phase</i> (master axis phase) for element number 0 in the array variable for the parameter specified for the <i>CamNodes</i> input variable is not 0.		Write the program so that the value of <i>Phase</i> (master axis phase) for element number 0 in the array variable for the parameter specified for the <i>CamNodes</i> input variable is not 0.	
Attached information	None					
Precautions/Remarks	None					

*1. This event code occurs for a CPU Unit with unit version 1.08 or later.

Event name	Cam Node Master Axis Phase Not in Ascending Order		Event code	57400000 hex*1		
Meaning	The values of <i>Phase</i> in the array variable of the parameter specified for the <i>CamNodes</i> input variable to a motion control instruction are not in ascending order according to the element numbers.					
Source	Motion Control Function Module		Source details	MC Common	Detection timing	At instruction execution
Error attributes	Level	Minor fault	Recovery	Error reset	Log category	System
Effects	User program	Continues.	Operation	Not affected.		
System-defined variables	Variable		Data type		Name	
	_MC_COM.MFaultLvl.Active		BOOL		MC Common Minor Fault Occurrence	
Cause and correction	Assumed cause		Correction		Prevention	
	The values of <i>Phase</i> (master axis phase) in the array variable of the parameter specified for the instruction are not in ascending order according to the element numbers. Or, truncating the digits that are not effective more than seven digits caused the phases not to be in ascending order.		Correct the program so that the values of <i>Phase</i> (master axis phase) in the array variable for the parameter specified for the <i>CamNodes</i> input variable are in ascending order according to the element numbers.		Write the program so that the values of <i>Phase</i> (master axis phase) in the array variable for the parameter specified for the <i>CamNodes</i> input variable are in ascending order according to the element numbers.	
Attached information	Attached Information 1: Element Number of Error Node Point					
Precautions/Remarks	None					

*1. This event code occurs for a CPU Unit with unit version 1.08 or later.

Event name	Too Many Data Points in Cam Table		Event code	57410000 hex ^{*1}		
Meaning	The number of generated cam data points exceeded the number of elements in the array in the cam data variable that is specified for the <i>CamTable</i> input variable to a motion control instruction.					
Source	Motion Control Function Module		Source details	MC Common	Detection timing	At instruction execution
Error attributes	Level	Minor fault	Recovery	Error reset	Log category	System
Effects	User program	Continues.	Operation	Not affected.		
System-defined variables	Variable	Data type		Name		
	_MC_COM.MFaultLvl.Active	BOOL		MC Common Minor Fault Occurrence		
Cause and correction	Assumed cause	Correction		Prevention		
	The number of cam data points in the generated cam table exceeded the number of elements in the array in the cam data variable that is specified for the <i>CamTable</i> input variable to the instruction.	Correct the program so that the number of cam data points in the generated cam table does not exceed the number of elements in the array in the cam data variable that is specified for the <i>CamTable</i> input variable to the instruction. Refer to information on the MC_GenerateCamTable (Generate Cam Table) instruction for the number of cam data points in generated cam tables.		Write the program so that the number of cam data points in the generated cam table does not exceed the number of elements in the array in the cam data variable that is specified for the <i>CamTable</i> input variable to the instruction. Refer to information on the MC_GenerateCamTable (Generate Cam Table) instruction for the number of cam data points in generated cam tables.		
Attached information	Attached Information 1: Element Number of Error Node Point					
Precautions/Remarks	None					

*1. This event code occurs for a CPU Unit with unit version 1.08 or later.

Event name	Cam Table Displacement Overflow		Event code	57420000 hex*1		
Meaning	<i>Distance</i> in the generated cam table exceeded the range of REAL data.					
Source	Motion Control Function Module	Source details	MC Common	Detection timing	At or during instruction execution	
Error attributes	Level	Minor fault	Recovery	Error reset	Log category	System
Effects	User program	Continues.	Operation	Not affected.		
System-defined variables	Variable	Data type		Name		
	_MC_COM.MFaultLvl.Active	BOOL		MC Common Minor Fault Occurrence		
Cause and correction	Assumed cause	Correction		Prevention		
	<i>Distance</i> in the generated cam table exceeded the range of REAL data.	Correct the values of <i>InitVel</i> (initial velocity), <i>ConnectingVel</i> (connecting velocity), and <i>ConnectingAcc</i> (connecting acceleration) so that <i>Distance</i> does not overflow when a polynomial 3 curve or polynomial 5 curve is specified for <i>Curve</i> (curve shape) in the <i>CamNodes</i> input variable. Refer to information on the MC_GenerateCamTable (Generate Cam Table) instruction for the method to calculate <i>Distance</i> .		Specify the values of <i>InitVel</i> (initial velocity), <i>ConnectingVel</i> (connecting velocity), and <i>ConnectingAcc</i> (connecting acceleration) so that <i>Distance</i> does not overflow when a polynomial 3 curve or polynomial 5 curve is specified for <i>Curve</i> (curve shape) in the <i>CamNodes</i> input variable. Refer to information on the MC_GenerateCamTable (Generate Cam Table) instruction for the method to calculate <i>Distance</i> .		
Attached information	Attached Information 1: Element Number of Error Node Point					
Precautions/Remarks	None					

*1. This event code occurs for a CPU Unit with unit version 1.08 or later.

Event name	Aborted Cam Table Used		Event code	57430000 hex*1		
Meaning	A cam data variable that was aborted during generation was specified for the <i>CamTable</i> input variable to an instruction.					
Source	Motion Control Function Module		Source details	MC common or axis	Detection timing	At instruction execution
Error attributes	Level	Minor fault	Recovery	Error reset	Log category	System
Effects	User program	Continues.	Operation	Not affected.		
System-defined variables	Variable	Data type		Name		
	_MC_COM.MFaultLvl.Active	BOOL		MC Common Minor Fault Occurrence		
	_MC_AX[*].MFaultLvl.Active	BOOL		Axis Minor Fault Occurrence		
Cause and correction	Assumed cause	Correction		Prevention		
	A cam data variable that was aborted during generation due to an error in the MC_GenerateCamTable (Generate Cam Table) instruction was specified for the <i>CamTable</i> input variable to the instruction.	Check the <i>ErrorID</i> (error code), <i>ErrorParameterCode</i> (parameter detail code), and <i>ErrorNodePointIndex</i> (node point element number) output variables from the MC_GenerateCamTable (Generate Cam Table) instruction and correct the program so that correct cam table variables are created.		Write the program so that the MC_GenerateCamTable (Generate Cam Table) instruction creates correct cam data variables. Or, write the program so that the relevant instruction is executed only when the MC_GenerateCamTable (Generate Cam Table) instruction ends normally.		
Attached information	None					
Precautions/Remarks	None					

*1. This event code occurs for a CPU Unit with unit version 1.08 or later.

Event name	Execution ID Setting Out of Range		Event code	57490000 hex*1		
Meaning	The parameter specified for the <i>ExecID</i> input variable to a motion control instruction is out of range.					
Source	Motion Control Function Module		Source details	Axis	Detection timing	At instruction execution
Error attributes	Level	Minor fault	Recovery	Error reset	Log category	System
Effects	User program	Continues.	Operation	Relevant axis decelerates to a stop if it is in motion.		
System-defined variables	Variable	Data type		Name		
	_MC_AX[*].MFaultLvl.Active	BOOL		Axis Minor Fault Occurrence		
Cause and correction	Assumed cause	Correction		Prevention		
	The parameter specified for the <i>ExecID</i> input variable to the instruction is out of range for the input variable.	Correct the program so that the input parameter specified for the <i>ExecID</i> input variable to the instruction is within the setting range.		Create the program so that the input parameter specified for the <i>ExecID</i> input variable to the instruction is within the setting range.		
Attached information	None					
Precautions/Remarks	None					

*1. This event code occurs for a CPU Unit with unit version 1.10 or later.

Event name	Position Offset Out of Range		Event code	574A0000 hex*1	
Meaning	The parameter specified for the <i>OffsetPosition</i> input variable to a motion control instruction is out of range.				
Source	Motion Control Function Module	Source details	Axis	Detection timing	At instruction execution
Error attributes	Level	Minor fault	Recovery	Error reset	Log category System
Effects	User program	Continues.	Operation	Operation is not possible for relevant axis. Relevant axis decelerates to a stop if it is in motion.	
System-defined variables	Variable	Data type		Name	
	_MC_AX[*].MFAultLvl.Active	BOOL		Axis Minor Fault Occurrence	
Cause and correction	Assumed cause		Correction		Prevention
	The instruction input parameter exceeded the range of signed 40-bit data when it is converted to pulses.		Correct the parameter so that the valid range of the input variable is not exceeded for the instruction.		Set the input parameter to the instruction so that the valid range of the input variable is not exceeded.
Attached information	None				
Precautions/Remarks	None				

*1. This event code occurs for a CPU Unit with unit version 1.10 or later.

Event name	PDS State Transition Command Selection Out of Range		Event code	574B0000 hex*1	
Meaning	The parameter specified for the <i>TransitionCmd</i> input variable to a motion control instruction is out of range.				
Source	Motion Control Function Module	Source details	Axis	Detection timing	At instruction execution
Error attributes	Level	Minor fault	Recovery	Error reset	Log category System
Effects	User program	Continues.	Operation	Operation is not possible for relevant axis. Relevant axis decelerates to a stop if it is in motion.	
System-defined variables	Variable	Data type		Name	
	_MC_AX[*].MFAultLvl.Active	BOOL		Axis Minor Fault Occurrence	
Cause and correction	Assumed cause		Correction		Prevention
	Instruction input parameter exceeded the valid range of the input variable.		Correct the parameter so that the valid range of the input variable is not exceeded for the instruction.		Set the input parameter to the instruction so that the valid range of the input variable is not exceeded.
Attached information	None				
Precautions/Remarks	None				

*1. This event code occurs for a CPU Unit with unit version 1.10 or later.

Event name	Single-axis Position Control Axis Motion Control Instruction Execution Disabled		Event code	574C0000 hex*1		
Meaning	An operation instruction was executed for a single-axis position control axis.					
Source	Motion Control Function Module		Source details	Axis	Detection timing	At instruction execution
Error attributes	Level	Minor fault	Recovery	Error reset	Log category	System
Effects	User program	Continues.	Operation	Operation is not possible for relevant axis. Relevant axis decelerates to a stop if it is in motion.		
System-defined variables	Variable		Data type		Name	
	_MC_AX[*].MFAultLvl.Active		BOOL		Axis Minor Fault Occurrence	
Cause and correction	Assumed cause		Correction		Prevention	
	An operation instruction was executed for a single-axis position control axis.		In the Axis Basic Settings for the axis specified in the instruction, set the Control Function parameter to 0: All. Or specify the axis for which the Control Function parameter is set to 0: All in the Axis Basic Settings.		Same as at the left.	
Attached information	None					
Precautions/Remarks	None					

*1. This event code occurs for unit version 1.13 or later of the CPU Unit.

Event name	Cam Monitor Mode Selection Out of Range		Event code	57510000 hex *1		
Meaning	The cam monitor mode selection specified for the <i>CamMonitorMode</i> input variable to a motion control instruction is out of range.					
Source	Motion Control Function Module		Source details	Axis	Detection timing	At instruction execution
Error attributes	Level	Minor fault	Recovery	Error reset	Log category	System
Effects	User program	Continues.	Operation	Operation is not possible for relevant axis. Relevant axis decelerates to a stop if it is in motion.		
System-defined variable	Variable		Data type		Name	
	_MC_AX[*].MFAultLvl.Active		BOOL		Axis Minor Fault Occurrence	
Cause and correction	Assumed cause		Correction		Prevention	
	The cam monitor mode selection is out of the valid range.		Make a correction so that the cam monitor mode selection is within the valid range.		Make a setting so that the cam monitor mode selection is within the valid range.	
Attached information	None					
Precautions/Remarks	None					

*1. This event code occurs for an NX102-□□□□ CPU Unit with unit version 1.32 or later and NX701-□□□00 CPU Unit, NX1P2-□□□□□ CPU Unit, NJ501-□□□□ CPU Unit (excluding NJ501-□□□20), NJ301-□□□□ CPU Unit, and NJ101-□□□00 CPU Unit with unit version 1.21 or later.

Event name	Data Type of Cam Monitor Values Mismatch		Event code	57520000 hex *1		
Meaning	The data type of the cam monitor values specified for the <i>CamMonitorValue</i> in-out variable to a motion control instruction does not match the cam monitor mode selection.					
Source	Motion Control Function Module		Source details	Axis	Detection timing	At instruction execution
Error attributes	Level	Minor fault	Recovery	Error reset	Log category	System
Effects	User program	Continues.	Operation	Operation is not possible for relevant axis. Relevant axis decelerates to a stop if it is in motion.		
system-defined variable	Variable	Data type		Name		
	_MC_AX[*].MFAultLvl.Active	BOOL		Axis Minor Fault Occurrence		
Cause and correction	Assumed cause		Correction		Prevention	
	The data type of the variable specified for the cam monitor values does not match the cam monitor mode selection.		Make a correction of the data type of the variable specified for the cam monitor values.		Set the data type of the variable specified for the cam monitor values correctly.	
Attached information	None					
Precautions/Remarks	None					

*1. This event code occurs for an NX102-□□□□ CPU Unit with unit version 1.32 or later and NX701-□□□□ CPU Unit, NX1P2-□□□□ CPU Unit, NJ501-□□□□ CPU Unit (excluding NJ501-□□□□20), NJ301-□□□□ CPU Unit, and NJ101-□□□□ CPU Unit with unit version 1.21 or later.

Event name	Sync Mode Setting Out of Range		Event code	57530000 hex *1		
Meaning	The parameter specified for the <i>SyncMode</i> input variable to a motion control instruction is out of range.					
Source	Motion Control Function Module		Source details	Axis	Detection timing	At instruction execution
Error attributes	Level	Minor fault	Recovery	Error reset	Log category	System
Effects	User program	Continues.	Operation	Operation is not possible for relevant slave axis. Relevant slave axis decelerates to a stop if it is in motion.		
System-defined variables	Variable	Data type		Name		
	_MC_AX[*].MFAultLvl.Active	BOOL		Axis Minor Fault Occurrence		
Cause and correction	Assumed cause		Correction		Prevention	
	Instruction input parameter exceeded the valid range of the input variable.		Correct the parameter so that the valid range of the input variable is not exceeded for the relevant instruction.		Set the input parameter to the instruction so that the valid range of the input variable is not exceeded.	
Attached information	None					
Precautions/Remarks	None					

*1. The event occurs for an NJ-series, NX102, NX1P2, or NX502 CPU Unit with unit version 1.70 or later and an NX701 CPU Unit with unit version 1.37 or later.

3 Error Descriptions and Corrections

Event name	Gear Master Axis Following First Position Setting Out of Range		Event code	57540000 hex *1		
Meaning	The parameter specified for the <i>MasterStartDistance</i> input variable to a motion control instruction is out of range.					
Source	Motion Control Function Module		Source details	Axis	Detection timing	At instruction execution
Error attributes	Level	Minor fault	Recovery	Error reset	Log category	System
Effects	User program	Continues.	Operation	Operation is not possible for relevant slave axis. Relevant slave axis decelerates to a stop if it is in motion.		
System-defined variables	Variable		Data type		Name	
	_MC_AX[*].MFAultLvl.Active		BOOL		Axis Minor Fault Occurrence	
Cause and correction	Assumed cause		Correction		Prevention	
	Instruction input parameter exceeded the valid range of the input variable.		Correct the parameter so that the valid range of the input variable is not exceeded for the relevant instruction.		Set the input parameter to the instruction so that the valid range of the input variable is not exceeded.	
Attached information	None					
Precautions/Remarks	None					

*1. The event occurs for an NJ-series, NX102, NX1P2, or NX502 CPU Unit with unit version 1.70 or later and an NX701 CPU Unit with unit version 1.37 or later.

Event name	Torque Limit Mode Setting Out of Range		Event code	57550000 hex *1		
Meaning	The parameter specified for the <i>TorqueLimitMode</i> input variable to a motion control instruction is out of range.					
Source	Motion Control Function Module		Source details	Axis	Detection timing	At instruction execution
Error attributes	Level	Minor fault	Recovery	Error reset	Log category	System
Effects	User program	Continues.	Operation	Operation is not possible for relevant slave axis. Relevant slave axis decelerates to a stop if it is in motion.		
System-defined variables	Variable		Data type		Name	
	_MC_AX[*].MFAultLvl.Active		BOOL		Axis Minor Fault Occurrence	
Cause and correction	Assumed cause		Correction		Prevention	
	Instruction input parameter exceeded the valid range of the input variable.		Correct the parameter so that the valid range of the input variable is not exceeded for the relevant instruction.		Set the input parameter to the instruction so that the valid range of the input variable is not exceeded.	
Attached information	None					
Precautions/Remarks	None					

*1. The event occurs for an NJ-series, NX102, NX1P2, or NX502 CPU Unit with unit version 1.70 or later and an NX701 CPU Unit with unit version 1.37 or later.

Event name	Insufficient Cam Nodes		Event code	57560000 hex *1		
Meaning	The array variable of the parameter specified for the <i>CamNodes</i> input variable to a motion control instruction has a <i>Phase</i> value of 0 for element number 0.					
Source	Motion Control Function Module		Source details	Axis	Detection timing	At instruction execution
Error attributes	Level	Minor fault	Recovery	Error reset	Log category	System
Effects	User program	Continues.	Operation	Operation is not possible for relevant slave axis. Relevant slave axis decelerates to a stop if it is in motion.		
System-defined variables	Variable	Data type		Name		
	_MC_AX[*].MFaultLvl.Active	BOOL		Axis Minor Fault Occurrence		
Cause and correction	Assumed cause		Correction		Prevention	
	The array variable of the parameter specified for <i>CamNodes</i> input variable to the instruction has a <i>Phase</i> (master axis phase) value of 0 for element number 0.		Correct the program so that the value of <i>Phase</i> (master axis phase) for element number 0 in the array variable for the parameter specified for the <i>CamNodes</i> input variable is not 0.		Write the program so that the value of <i>Phase</i> (master axis phase) for element number 0 in the array variable for the parameter specified for the <i>CamNodes</i> input variable is not 0.	
Attached information	None					
Precautions/Remarks	None					

*1. The event occurs for an NJ-series, NX102, NX1P2, or NX502 CPU Unit with unit version 1.70 or later and an NX701 CPU Unit with unit version 1.37 or later.

Event name	Cam Node Start Point Position Out of Range		Event code	57570000 hex *1		
Meaning	The parameter specified for the <i>StartPosition</i> input variable to a motion control instruction is out of range.					
Source	Motion Control Function Module		Source details	Axis	Detection timing	At instruction execution
Error attributes	Level	Minor fault	Recovery	Error reset	Log category	System
Effects	User program	Continues.	Operation	Operation is not possible for relevant slave axis. Relevant slave axis decelerates to a stop if it is in motion.		
System-defined variables	Variable	Data type		Name		
	_MC_AX[*].MFaultLvl.Active	BOOL		Axis Minor Fault Occurrence		
Cause and correction	Assumed cause		Correction		Prevention	
	Instruction input parameter exceeded the valid range of the input variable.		Correct the parameter so that the valid range of the input variable is not exceeded for the relevant instruction.		Set the input parameter to the instruction so that the valid range of the input variable is not exceeded.	
Attached information	None					
Precautions/Remarks	None					

*1. The event occurs for an NJ-series, NX102, NX1P2, or NX502 CPU Unit with unit version 1.70 or later and an NX701 CPU Unit with unit version 1.37 or later.

Event name	Cam Operation Displacement Overflow		Event code	57580000 hex *1	
Meaning	The displacement calculated for the cam operation is out of range.				
Source	Motion Control Function Module		Source details	Axis	Detection timing At instruction execution or during instruction execution
Error attributes	Level	Minor fault	Recovery	Error reset	Log category System
Effects	User program	Continues.	Operation	Operation is not possible for relevant slave axis. Relevant slave axis decelerates to a stop if it is in motion.	
System-defined variables	Variable	Data type		Name	
	_MC_AX[*].MFAultLvl.Active	BOOL		Axis Minor Fault Occurrence	
Cause and correction	Assumed cause	Correction		Prevention	
	The absolute value of the product of the cam profile curve displacement and the <i>SlaveScaling</i> input variable when it is converted to pulses exceeds the range of 40-bit data.	Make corrections so that the product of the cam profile curve displacement and the <i>SlaveScaling</i> input variable is not out of range. When a polynomial 3 or polynomial 5 curve is specified for the <i>Curve</i> in the <i>CamNodes</i> input variable, make adjustments so that the displacement is within range based on the equations described in the MC_CamInCurve (Start Cam Operation With Specified Curve) instruction.		Make corrections so that the product of the cam profile curve displacement and the <i>SlaveScaling</i> input variable is not out of range. When a polynomial 3 or polynomial 5 curve is specified for the <i>Curve</i> in the <i>CamNodes</i> input variable, make adjustments so that the displacement is within range based on the equations described in the MC_CamInCurve (Start Cam Operation With Specified Curve) instruction.	
Attached information	None				
Precautions/Remarks	None				

*1. The event occurs for an NJ-series, NX102, NX1P2, or NX502 CPU Unit with unit version 1.70 or later and an NX701 CPU Unit with unit version 1.37 or later.

Event name	Reversing Operation Not Possible		Event code	57590000 hex *1		
Meaning	When Slave axis reversing not possible is specified in the <i>SyncMode</i> input variable to a motion control instruction, the slave axis has entered an operation pattern causing reversing motion.					
Source	Motion Control Function Module		Source details	Axis	Detection timing	At instruction execution or during instruction execution
Error attributes	Level	Minor fault	Recovery	Error reset	Log category	System
Effects	User program	Continues.	Operation	Operation is not possible for relevant slave axis. Relevant slave axis decelerates to a stop if it is in motion.		
System-defined variables	Variable	Data type		Name		
	_MC_AX[*].MFAultLvl.Active	BOOL		Axis Minor Fault Occurrence		
Cause and correction	Assumed cause		Correction		Prevention	
	When Slave axis reversing not possible is specified in the <i>SyncMode</i> input variable, the slave axis has entered an operation causing reversing motion due to the difference in the direction of velocity at the start of catching and during synchronization.		Correct the program based on the operating specifications of the MC_GearInPos2 (Positioning Gear Operation2) instruction so that the direction of velocity at the start of catching and during synchronization matches.		Correct the program based on the operating specifications of the MC_GearInPos2 (Positioning Gear Operation2) instruction so that the direction of velocity at the start of catching and during synchronization matches.	
Attached information	None					
Precautions/Remarks	None					

*1. The event occurs for an NJ-series, NX102, NX1P2, or NX502 CPU Unit with unit version 1.70 or later and an NX701 CPU Unit with unit version 1.37 or later.

Event name	Target Position Positive Software Limit Exceeded		Event code	64400000 hex		
Meaning	The specified position exceeds the positive software limit.					
Source	Motion Control Function Module		Source details	Axis/axes group	Detection timing	At instruction execution
Error attributes	Level	Minor fault	Recovery	Error reset	Log category	System
Effects	User program	Continues.	Operation	<p>If “axis” is given for the source details, operation is not possible for relevant axis. Relevant axis decelerates to a stop if it is in motion.</p> <p>If “axes group” is given for the source details, operation is not possible for relevant axes group. Relevant axes group decelerates to a stop if it is in motion.</p>		
System-defined variables	Variable		Data type	Name		
		_MC_AX[*].MFAultLvl.Active	BOOL	Axis Minor Fault Occurrence		
		_MC_GRP[*].MFAultLvl.Active	BOOL	Axes Group Minor Fault Occurrence		
Cause and correction	Assumed cause		Correction	Prevention		
		The parameter specified for the <i>Position</i> input variable to the instruction is beyond the positive software limit.	Correct the parameter specified for the <i>Position</i> input variable to the instruction so that it is within the positive software limit.	Set the parameter specified for the <i>Position</i> input variable to the instruction so that it is within the positive software limit.		
		The starting position is beyond the positive software limit and an instruction that specifies motion in the opposite direction of the software limit was executed.	Correct the program so that the travel direction for the instruction is towards the positive software limit.	If the starting position is beyond the positive software limit, write the program so that the travel direction is in the direction of the positive software limit.		
	The parameter that was specified for the <i>AuxPoint</i> input variable to a border point MC_MoveCircular2D (Circular 2D Interpolation) instruction is beyond the positive software limit.	Correct the parameter specified for the <i>AuxPoint</i> input variable to the instruction so that it is within the positive software limit.	Set the parameter specified for the <i>AuxPoint</i> input variable to the border point MC_MoveCircular2D (Circular 2D Interpolation) instruction so that it is within the negative software limit.			
Attached information	Attached Information 1: Depends on the source details. <ul style="list-style-type: none"> • Axis: 0 • Axes group: Logical axis number 					
Precautions/Remarks	None					

Event name	Target Position Negative Software Limit Exceeded		Event code	64410000 hex		
Meaning	The specified position exceeds the negative software limit.					
Source	Motion Control Function Module		Source details	Axis/axes group	Detection timing	At instruction execution
Error attributes	Level	Minor fault	Recovery	Error reset	Log category	System
Effects	User program	Continues.	Operation	<p>If “axis” is given for the source details, operation is not possible for relevant axis. Relevant axis decelerates to a stop if it is in motion.</p> <p>If “axes group” is given for the source details, operation is not possible for relevant axes group. Relevant axes group decelerates to a stop if it is in motion.</p>		
System-defined variables	Variable		Data type	Name		
		_MC_AX[*].MFAultLvl.Active	BOOL	Axis Minor Fault Occurrence		
		_MC_GRP[*].MFAultLvl.Active	BOOL	Axes Group Minor Fault Occurrence		
Cause and correction	Assumed cause		Correction	Prevention		
		The parameter specified for the <i>Position</i> input variable to the instruction is beyond the negative software limit.	Correct the parameter specified for the <i>Position</i> input variable to the instruction so that it is within the negative software limit.	Correct the input parameter specified for the <i>Position</i> input variable to the instruction so that it is within the negative software limit.		
		The starting position is beyond the negative software limit and an instruction that specifies motion in the opposite direction of the software limit was executed.	Correct the program so that the travel direction for the instruction is towards the negative software limit.	If the starting position is beyond the negative software limit, write the program so that the travel direction is in the direction of the negative software limit.		
	The parameter that was specified for the <i>AuxPoint</i> input variable to a border point MC_MoveCircular2D (Circular 2D Interpolation) instruction is beyond the negative software limit.	Correct the parameter specified for the <i>AuxPoint</i> input variable to the instruction so that it is within the negative software limit.	Set the parameter specified for the <i>AuxPoint</i> input variable to the border point MC_MoveCircular2D (Circular 2D Interpolation) instruction so that it is within the negative software limit.			
Attached information	Attached Information 1: Depends on the source details. <ul style="list-style-type: none"> • Axis: 0 • Axes group: Logical axis number 					
Precautions/Remarks	None					

Event name	Command Position Overflow/Underflow		Event code	64420000 hex	
Meaning	Positioning, an instruction in the underflow/overflow direction, or an instruction for which the direction is not specified was executed when there was an underflow/overflow in the command position.				
Source	Motion Control Function Module		Source details	Axis	Detection timing At instruction execution
Error attributes	Level	Minor fault	Recovery	Error reset	Log category System
Effects	User program	Continues.	Operation	Operation is not possible for relevant axis. Relevant axis decelerates to a stop if it is in motion.	
System-defined variables	Variable	Data type		Name	
	_MC_AX[*].MFAultLvl.Active	BOOL		Axis Minor Fault Occurrence	
Cause and correction	Assumed cause		Correction		Prevention
	<p>One of the following was executed when there was a command position overflow/underflow.</p> <ul style="list-style-type: none"> • A positioning instruction • A continuous control instruction in the underflow/overflow direction • An instruction for which the direction is not specified (syncing or torque control) 		Execute an error reset and then clear the overflow/underflow state by executing homing or presetting the actual position.		Make sure that overflow or underflow does not occur.
Attached information	None				
Precautions/Remarks	None				

Event name	Positive Limit Input		Event code	64430000 hex		
Meaning	An instruction was executed for a motion in the positive direction when the positive limit input was ON.					
Source	Motion Control Function Module		Source details	Axis/axes group	Detection timing	At instruction execution
Error attributes	Level	Minor fault	Recovery	Error reset	Log category	System
Effects	User program	Continues.	Operation	If "axis" is given for the source details, operation is not possible for relevant axis. If "axes group" is given for the source details, operation is not possible for relevant axes group.		
System-defined variables	Variable		Data type	Name		
		_MC_AX[*].MFAultLvl.Active	BOOL	Axis Minor Fault Occurrence		
		_MC_GRP[*].MFAultLvl.Active	BOOL	Axes Group Minor Fault Occurrence		
Cause and correction	Assumed cause	Correction		Prevention		
	An instruction for a motion in the positive direction was executed when the positive limit input was ON, or an instruction for a motion with no direction specification was executed when the positive limit input was ON. An axes group motion control instruction was executed when the positive limit input was ON.	Execute an error reset and then perform a recovery operation in the negative direction. If the error occurred during an axes group motion control instruction, disable the axes group and then perform the above operation. If this error occurs again, check the connection of the positive limit signal, the logic setting for the positive limit input, and the execution conditions for the start command, and correct any mistakes. Check the logic settings both in the axis parameters and in the slave settings.		Check to make sure there are no problems with the positive limit signal connection, the logic setting for the positive limit input, and the execute conditions for the instruction. Check the logic settings both in the axis parameters and in the slave settings.		
Attached information	Attached Information 1: Depends on the source details. <ul style="list-style-type: none"> • Axis: 0 • Axes group: Logical axis number 					
Precautions/Remarks	None					

3 Error Descriptions and Corrections

Event name	Negative Limit Input			Event code	64440000 hex	
Meaning	An instruction for a motion in the negative direction was executed when the negative limit input was ON.					
Source	Motion Control Function Module		Source details	Axis/axes group	Detection timing	At instruction execution
Error attributes	Level	Minor fault	Recovery	Error reset	Log category	System
Effects	User program	Continues.	Operation	<p>If “axis” is given for the source details, operation is not possible for relevant axis.</p> <p>If “axes group” is given for the source details, operation is not possible for relevant axes group.</p>		
System-defined variables	Variable		Data type		Name	
	_MC_AX[*].MFaultLvl.Active		BOOL		Axis Minor Fault Occurrence	
	_MC_GRP[*].MFaultLvl.Active		BOOL		Axes Group Minor Fault Occurrence	
Cause and correction	Assumed cause		Correction		Prevention	
	<p>An instruction for a motion in the negative direction was executed when the negative limit input was ON, or an instruction for a motion with no direction specification was executed when the negative limit input was ON. An axes group motion control instruction was executed when the negative limit input was ON.</p>		<p>Execute an error reset and then perform a recovery operation in the positive direction. If the error occurred during an axes group motion control instruction, disable the axes group and then perform the above operation. If this error occurs again, check the connection of the negative limit signal, the logic setting for the negative limit input, and the execution conditions for the start command, and correct any mistakes.</p> <p>Check the logic settings both in the axis parameters and in the slave settings.</p>		<p>Check to make sure there are no problems with the negative limit signal connection, the logic setting for the negative limit input, and the execute conditions for the instruction.</p> <p>Check the logic settings both in the axis parameters and in the slave settings.</p>	
Attached information	<p>Attached Information 1: Depends on the source details.</p> <ul style="list-style-type: none"> • Axis: 0 • Axes group: Logical axis number 					
Precautions/Remarks	None					

Event name	Servo Main Circuits OFF			Event code	74220000 hex	
Meaning	An attempt was made to turn ON the Servo when the main circuit power supply to the Servo Drive was OFF.					
Source	Motion Control Function Module		Source details	Axis	Detection timing	At instruction execution
Error attributes	Level	Minor fault	Recovery	Error reset	Log category	System
Effects	User program	Continues.	Operation	The Servo for the axis turns OFF.		
System-defined variables	Variable		Data type		Name	
	_MC_AX[*].MFaultLvl.Active		BOOL		Axis Minor Fault Occurrence	
Cause and correction	Assumed cause		Correction		Prevention	
	<p>An attempt was made to turn ON the Servo when the main circuit power supply to the Servo Drive was OFF.</p>		<p>Turn ON the Servo after turning ON the main circuit power of the Servo Drive for the axis where the error occurred.</p>		<p>Turn ON the Servo after turning ON the main circuit power supply to the Servo Drive.</p>	
Attached information	None					
Precautions/Remarks	None					

Event name	Actual Position Overflow/Underflow		Event code	57220000 hex*1		
Meaning	An instruction was executed that is not supported during an actual position overflow/underflow.					
Source	Motion Control Function Module	Source details	Axis	Detection timing	At instruction execution	
Error attributes	Level	Observation	Recovery	---	Log category	System
Effects	User program	Continues.	Operation	Not affected.		
System-defined variables	Variable	Data type		Name		
	_MC_AX[*].Obsr.Active	BOOL		Axis Observation Occurrence		
Cause and correction	Assumed cause	Correction		Prevention		
	An instruction was executed that is not supported during an actual position overflow or underflow.	Execute an error reset and then clear the overflow or underflow state by changing the current position or homing.		Write the program so that overflows and underflows do not occur.		
Attached information	None					
Precautions/Remarks	None					

*1. This event code occurs for a CPU Unit with unit version 1.06 or later.

Event name	Switch Structure Track Number Setting Out of Range		Event code	57230000 hex*1		
Meaning	The value of <i>TrackNumber</i> that is specified in the <i>Switches</i> in-out variable to a motion control instruction is out of range.					
Source	Motion Control Function Module	Source details	Axis	Detection timing	At instruction execution	
Error attributes	Level	Observation	Recovery	---	Log category	System
Effects	User program	Continues.	Operation	Not affected.		
System-defined variables	Variable	Data type		Name		
	_MC_AX[*].Obsr.Active	BOOL		Axis Observation Occurrence		
Cause and correction	Assumed cause	Correction		Prevention		
	The value of the member of the structure variable that was specified for the in-out variable of the instruction is out of range.	Correct the value of the member of the structure variable that is specified for the in-out variable of the relevant instruction so that it is in the valid range.		Make sure that the value of the member of the structure variable that is specified for the in-out variable of the relevant instruction is in the valid range.		
Attached information	None					
Precautions/Remarks	None					

*1. This event code occurs for a CPU Unit with unit version 1.06 or later.

3 Error Descriptions and Corrections

Event name	Switch Structure First ON Position Setting Out of Range		Event code	57240000 hex ^{*1}		
Meaning	The value of <i>FirstOnPosition</i> that is specified in the <i>Switches</i> in-out variable to a motion control instruction is out of range.					
Source	Motion Control Function Module		Source details	Axis	Detection timing	At instruction execution
Error attributes	Level	Observation	Recovery	---	Log category	System
Effects	User program	Continues.	Operation	Not affected.		
System-defined variables	Variable		Data type		Name	
	_MC_AX[*].Obsr.Active		BOOL		Axis Observation Occurrence	
Cause and correction	Assumed cause		Correction		Prevention	
	The value of the member of the structure variable that was specified for the in-out variable of the instruction is out of range.		Correct the value of the member of the structure variable that is specified for the in-out variable of the relevant instruction so that it is in the valid range.		Make sure that the value of the member of the structure variable that is specified for the in-out variable of the relevant instruction is in the valid range.	
Attached information	None					
Precautions/Remarks	None					

*1. This event code occurs for a CPU Unit with unit version 1.06 or later.

Event name	Switch Structure Last ON Position Setting Out of Range		Event code	57250000 hex ^{*1}		
Meaning	The value of <i>LastOnPosition</i> that is specified in the <i>Switches</i> in-out variable to a motion control instruction is out of range.					
Source	Motion Control Function Module		Source details	Axis	Detection timing	At instruction execution
Error attributes	Level	Observation	Recovery	---	Log category	System
Effects	User program	Continues.	Operation	Not affected.		
System-defined variables	Variable		Data type		Name	
	_MC_AX[*].Obsr.Active		BOOL		Axis Observation Occurrence	
Cause and correction	Assumed cause		Correction		Prevention	
	The value of the member of the structure variable that was specified for the in-out variable of the instruction is out of range.		Correct the value of the member of the structure variable that is specified for the in-out variable of the relevant instruction so that it is in the valid range.		Make sure that the value of the member of the structure variable that is specified for the in-out variable of the relevant instruction is in the valid range.	
Attached information	None					
Precautions/Remarks	None					

*1. This event code occurs for a CPU Unit with unit version 1.06 or later.

Event name	Switch Structure Axis Direction Out of Range		Event code	57260000 hex*1	
Meaning	The value of <i>AxisDirection</i> that is specified in the <i>Switches</i> in-out variable to a motion control instruction is out of range.				
Source	Motion Control Function Module		Source details	Axis	Detection timing At instruction execution
Error attributes	Level	Observation	Recovery	---	Log category System
Effects	User program	Continues.	Operation	Not affected.	
System-defined variables	Variable		Data type		Name
	_MC_AX[*].Obsr.Active		BOOL		Axis Observation Occurrence
Cause and correction	Assumed cause		Correction		Prevention
	The value of the member of the structure variable that was specified for the in-out variable of the instruction is out of range.		Correct the value of the member of the structure variable that is specified for the in-out variable of the relevant instruction so that it is in the valid range.		Make sure that the value of the member of the structure variable that is specified for the in-out variable of the relevant instruction is in the valid range.
Attached information	None				
Precautions/Remarks	None				

*1. This event code occurs for a CPU Unit with unit version 1.06 or later.

Event name	Switch Structure Cam Switch Mode Out of Range		Event code	57270000 hex*1	
Meaning	The value of <i>CamSwitchMode</i> that is specified in the <i>Switches</i> in-out variable to a motion control instruction is out of range.				
Source	Motion Control Function Module		Source details	Axis	Detection timing At instruction execution
Error attributes	Level	Observation	Recovery	---	Log category System
Effects	User program	Continues.	Operation	Not affected.	
System-defined variables	Variable		Data type		Name
	_MC_AX[*].Obsr.Active		BOOL		Axis Observation Occurrence
Cause and correction	Assumed cause		Correction		Prevention
	The value of the member of the structure variable that was specified for the in-out variable of the instruction is out of range.		Correct the value of the member of the structure variable that is specified for the in-out variable of the relevant instruction so that it is in the valid range.		Make sure that the value of the member of the structure variable that is specified for the in-out variable of the relevant instruction is in the valid range.
Attached information	None				
Precautions/Remarks	None				

*1. This event code occurs for a CPU Unit with unit version 1.06 or later.

3 Error Descriptions and Corrections

Event name	Switch Structure Duration Setting Out of Range		Event code	57280000 hex ^{*1}		
Meaning	The value of <i>Duration</i> that is specified in the <i>Switches</i> in-out variable to a motion control instruction is out of range.					
Source	Motion Control Function Module	Source details	Axis	Detection timing	At instruction execution	
Error attributes	Level	Observation	Recovery	---	Log category	System
Effects	User program	Continues.	Operation	Not affected.		
System-defined variables	Variable	Data type		Name		
	_MC_AX[*].Obsr.Active	BOOL		Axis Observation Occurrence		
Cause and correction	Assumed cause	Correction		Prevention		
	The value of the member of the structure variable that was specified for the in-out variable of the instruction is out of range.	Correct the value of the member of the structure variable that is specified for the in-out variable of the relevant instruction so that it is in the valid range.		Make sure that the value of the member of the structure variable that is specified for the in-out variable of the relevant instruction is in the valid range.		
Attached information	None					
Precautions/Remarks	None					

*1. This event code occurs for a CPU Unit with unit version 1.06 or later.

Event name	Track Option Structure ON Compensation Setting Out of Range		Event code	57290000 hex ^{*1}		
Meaning	The value of <i>OnCompensation</i> that is specified in the <i>TrackOptions</i> in-out variable to a motion control instruction is out of range.					
Source	Motion Control Function Module	Source details	Axis	Detection timing	At instruction execution	
Error attributes	Level	Observation	Recovery	---	Log category	System
Effects	User program	Continues.	Operation	Not affected.		
System-defined variables	Variable	Data type		Name		
	_MC_AX[*].Obsr.Active	BOOL		Axis Observation Occurrence		
Cause and correction	Assumed cause	Correction		Prevention		
	The value of the member of the structure variable that was specified for the in-out variable of the instruction is out of range.	Correct the value of the member of the structure variable that is specified for the in-out variable of the relevant instruction so that it is in the valid range.		Make sure that the value of the member of the structure variable that is specified for the in-out variable of the relevant instruction is in the valid range.		
Attached information	None					
Precautions/Remarks	None					

*1. This event code occurs for a CPU Unit with unit version 1.06 or later.

Event name	Track Option Structure OFF Compensation Setting Out of Range		Event code	572A0000 hex*1		
Meaning	The value of <i>OffCompensation</i> that is specified in the <i>TrackOptions</i> in-out variable to a motion control instruction is out of range.					
Source	Motion Control Function Module		Source details	Axis	Detection timing	At instruction execution
Error attributes	Level	Observation	Recovery	---	Log category	System
Effects	User program	Continues.	Operation	Not affected.		
System-defined variables	Variable	Data type		Name		
	_MC_AX[*].Obsr.Active	BOOL		Axis Observation Occurrence		
Cause and correction	Assumed cause	Correction		Prevention		
	The value of the member of the structure variable that was specified for the in-out variable of the instruction is out of range.	Correct the value of the member of the structure variable that is specified for the in-out variable of the relevant instruction so that it is in the valid range.		Make sure that the value of the member of the structure variable that is specified for the in-out variable of the relevant instruction is in the valid range.		
Attached information	None					
Precautions/Remarks	None					

*1. This event code occurs for a CPU Unit with unit version 1.06 or later.

Event name	Number of Array Elements in Switch Structure Variable Out of Range		Event code	572B0000 hex*1		
Meaning	The number of elements in an array in the structure variable that is specified in the <i>Switches</i> in-out variable to a motion control instruction is out of range.					
Source	Motion Control Function Module		Source details	Axis	Detection timing	At instruction execution
Error attributes	Level	Observation	Recovery	Error reset	Log category	System
Effects	User program	Continues.	Operation	Not affected.		
System-defined variables	Variable	Data type		Name		
	_MC_AX[*].Obsr.Active	BOOL		Axis Observation Occurrence		
Cause and correction	Assumed cause	Correction		Prevention		
	The number of elements in an array of the structure variable that was specified for the in-out variable of the instruction is out of range.	Correct the number of elements in the array in the structure variable that is specified for the in-out variable of the relevant instruction so that it is in the valid range.		Make sure that the number of elements in the array in the structure variable that is specified for the in-out variable of the relevant instruction is in the valid range.		
Attached information	None					
Precautions/Remarks	None					

*1. This event code occurs for a CPU Unit with unit version 1.06 or later.

3 Error Descriptions and Corrections

Event name	Number of Array Elements in Output Signal Structure Variable Out of Range		Event code	572C0000 hex*1		
Meaning	The number of elements in an array in the structure variable that is specified in the <i>Outputs</i> in-out variable to a motion control instruction is out of range.					
Source	Motion Control Function Module		Source details	Axis	Detection timing	At instruction execution
Error attributes	Level	Observation	Recovery	---	Log category	System
Effects	User program	Continues.	Operation	Not affected.		
System-defined variables	Variable		Data type		Name	
	_MC_AX[*].Obsr.Active		BOOL		Axis Observation Occurrence	
Cause and correction	Assumed cause		Correction		Prevention	
	The number of elements in an array of the structure variable that was specified for the in-out variable of the instruction is out of range.		Correct the number of elements in the array in the structure variable that is specified for the in-out variable of the relevant instruction so that it is in the valid range.		Make sure that the number of elements in the array in the structure variable that is specified for the in-out variable of the relevant instruction is in the valid range.	
Attached information	None					
Precautions/Remarks	None					

*1. This event code occurs for a CPU Unit with unit version 1.06 or later.

Event name	Number of Array Elements in Track Option Structure Variable Out of Range		Event code	572D0000 hex*1		
Meaning	The number of elements in an array in the structure variable that is specified in the <i>TrackOptions</i> in-out variable to a motion control instruction is out of range.					
Source	Motion Control Function Module		Source details	Axis	Detection timing	At instruction execution
Error attributes	Level	Observation	Recovery	---	Log category	System
Effects	User program	Continues.	Operation	Not affected.		
System-defined variables	Variable		Data type		Name	
	_MC_AX[*].Obsr.Active		BOOL		Axis Observation Occurrence	
Cause and correction	Assumed cause		Correction		Prevention	
	The number of elements in an array of the structure variable that was specified for the in-out variable of the instruction is out of range.		Correct the number of elements in the array in the structure variable that is specified for the in-out variable of the relevant instruction so that it is in the valid range.		Make sure that the number of elements in the array in the structure variable that is specified for the in-out variable of the relevant instruction is in the valid range.	
Attached information	None					
Precautions/Remarks	None					

*1. This event code occurs for a CPU Unit with unit version 1.06 or later.

Event name	Numbers of Elements in Output Signals and Track Option Arrays Not Matched		Event code	572E0000 hex*1		
Meaning	The arrays in the structure variables that are specified for the <i>Outputs</i> and <i>TrackOptions</i> in-out variables to a motion control instruction do not have the same number of elements.					
Source	Motion Control Function Module		Source details	Axis	Detection timing	At instruction execution
Error attributes	Level	Observation	Recovery	---	Log category	System
Effects	User program	Continues.	Operation	Not affected.		
System-defined variables	Variable	Data type		Name		
	_MC_AX[*].Obsr.Active	BOOL		Axis Observation Occurrence		
Cause and correction	Assumed cause	Correction		Prevention		
	The arrays in the output signal structure variable and track option structure variable that are specified for the in-out variables to the instruction do not have the same number of elements.	Correct the output signal structure variable and track option structure variable that are specified for the in-out variables to the relevant instruction so that the arrays in them have the same number of elements.		Make sure that the arrays in the output signal structure variable and track option structure variable that are specified for the in-out variables to the relevant instruction have the same number of elements.		
Attached information	None					
Precautions/Remarks	None					

*1. This event code occurs for a CPU Unit with unit version 1.06 or later.

Event name	Same Track Number Setting in Switch Structure Out of Range		Event code	57310000 hex*1		
Meaning	The same track number was specified more than the allowable number of times for the <i>TrackNumber</i> in the <i>Switches</i> in-out variable to a motion control instruction.					
Source	Motion Control Function Module		Source details	Axis	Detection timing	At instruction execution
Error attributes	Level	Observation	Recovery	---	Log category	System
Effects	User program	Continues.	Operation	Not affected.		
System-defined variables	Variable	Data type		Name		
	_MC_AX[*].Obsr.Active	BOOL		Axis Observation Occurrence		
Cause and correction	Assumed cause	Correction		Prevention		
	The same track number was specified more than the allowable number of times for the <i>TrackNumber</i> in the <i>Switches</i> in-out variable to a motion control instruction.	Correct the values in the <i>TrackNumber</i> so that the same track number is not specified more than the maximum number of times.		Set the values in the <i>TrackNumber</i> so that the same track number is not specified more than the maximum number of times.		
Attached information	None					
Precautions/Remarks	None					

*1. This event code occurs for a CPU Unit with unit version 1.06 or later.

3-6-3 Other Troubles and Corrections

This section describes remedial actions to take when problems occur the first time you use the MC Function Module or after starting operation.

Preliminary Check Items

If an error occurs, check the items below to investigate the problem.

Category	Item to check
Installation conditions	Is there dust in the ambient environment?
	Are there conductive foreign matters (metal, carbon, etc.) in the ambient environment that might enter the Controller?
	Is the ambient temperature higher than the ambient operating temperature in the specifications?
	Is the ambient area humid (due to moisture in the air, use of water, etc.)?
	Does the ambient air contain corrosive gases (acid, salt, sulfur, etc.)?
	Are there sources of noise around the Controller (welders, inverters, etc.)?
Wiring	Are power supply lines wired in the same duct as the signal lines?
	Is the Controller grounded properly?
	Is there a noise filter in the power supply?
Changes	Was any extension work (welding work) done lately?
	Was any power supply facility added lately?
	Was the system (including its program) modified in any way (including additions)?
Accidents	Was there a lightning strike nearby?
	Was there a ground-fault accident or was the earth leakage breaker tripped?
	Was there a power outage?

Problems and Countermeasures

This section describes troubleshooting when the MC Function Module is used in combination with an OMRON 1S-series Servo Drive or G5-series Servo Drive.

If an unexpected operation is performed, data such as parameter settings or cam data may not have been transferred properly to the CPU Unit from the Sysmac Studio.

Furthermore, variables may not be working properly between the user program and the MC Function Module.

Use the data tracing function of Sysmac Studio to check if variables are exchanged at the correct timings.

Problem	Cause	Item to check	Countermeasure
Motor does not lock.	The MC Function Module does not output operation commands to the Servo Drive.	Make sure that you execute the MC_Power instruction.	Correct the program.
	Servo Drive setting error	Check the Servo Drive settings.	Set the Servo Drives correctly.

Problem	Cause	Item to check	Countermeasure
Motor does not run.	The drive prohibit input of the Servo Drive is enabled.	Use the Servo Drive software to check the drive prohibit input.	Cancel the drive prohibit input of the Servo Drive. Change the setting so that you do not use the drive prohibit input of the Servo Drive.
	Servo Drive error	Check for a Servo Drive error.	If there is an error, follow troubleshooting procedures for it.
	Mechanical axis is locked.	Check for contact with mechanical limits and check to see if mechanical parts are caught on something.	Manually release the locked mechanical axis.
	CPU Unit failure	---	Replace the CPU Unit.
Homing cannot be performed.	Error	Check the nature of the error.	If there is an error, follow troubleshooting procedures for it.
	Incorrect wiring of the home proximity input.	Check the axis input information in the Axis Variables to see if the home proximity input sensor turns ON/OFF.	Wire all connections correctly.
	Incorrect wiring of the home input.	Check the wiring of the home input.	Wire all connections correctly.
	The rotation direction and limit input direction are inconsistent.	If the axis moves to the mechanical limit without reversing at the limit, check the axis input information in the Axis Variables to see if the limit input turns ON and OFF.	Wire the limit inputs correctly.
	Incorrect wiring of the limit input	Check the wiring of the limit inputs.	Wire all connections correctly.
	InPosWaiting does not change to FALSE.	Check to see if the Servo Drive gain is too low. Check to see if the in-position range is too narrow.	Increase the Servo Drive gain. Increase the in-position range.
	Homing approach velocity is too high.	Check the homing approach velocity.	Lower the homing approach velocity of the MC Function Module.
	Axis parameters are not set correctly.	Check the axis parameters in the Sysmac Studio.	After setting the axis parameters correctly, download them to the MC Function Module.
The position of home defined with homing changes occasionally.	CPU Unit failure	---	Replace the CPU Unit.
	Loose mechanical parts, such as couplings	Use a marker pen to mark the motor shafts, couplings, and other mechanical connections to check for shifting.	Securely tighten the connections that shifted.
	Insufficient leeway for Z phase Insufficient leeway for home input signal	If the value is close to the setting per Servomotor rotation (number of pulses per encoder rotation) or near zero, the home may be shifted by one motor rotation due to slight changes in the timing of reading the sensor input.	Remove the motor coupling and shift the position by around one-quarter of a turn so that the Z phase pulse occurs at around one half of a Servomotor rotation (number of pulses per encoder rotation), and then perform homing again.

Problem	Cause	Item to check	Countermeasure
Unstable motor rotation	Incorrect wiring of Servomotor power line/ encoder line, missing phase, etc.	Check the wiring of the motor power line and encoder line.	Wire all connections correctly.
	Load torque variation due to gear meshing or not tightening the coupling eccentric screw connecting the motor axis with the mechanical system	Check the machine. Turn the coupling under a no-load condition (with the mechanical part after the coupling removed).	Review and adjust the machine.
	Insufficient gain adjustment	---	Perform auto-tuning of the Servomotor. Manually adjust the Servomotor gain.
	Incorrect Servomotor selection (adjustment not possible)	Select another motor (check the torque and inertia ratio).	Change to an optimal motor.
	Damaged Servomotor bearings	Turn OFF the Servo Drive power supply, and also turn ON the brake power supply and release the brake if the motor comes with a brake. Then manually turn the motor output shaft with the motor power line disconnected (because the dynamic brake may be applied).	Replace the Servomotor.
	Broken Servomotor winding	Use a tester to check the resistance between phases U, V, and W of the motor power line. If the balance is off, there is a problem.	Replace the Servomotor.
Rotation direction is reversed.	The Servo Drive is set to the opposite rotation direction.	Jog the machine. If the rotation direction of the Servo Drive is opposite the jogging direction, the rotation direction of the Servo Drive is reversed. Also check for reversed feedback signals (phases A and B) and reverse rotation setting of the parameter.	Set the rotation direction of the Servo Drive correctly.
	(During homing) The axis parameters that set the polarity of the home proximity sensor and the polarity of the home proximity input do not match.	Check the axis parameters and sensor polarity again.	Set the correct axis parameters.
	(During homing) Incorrect wiring of the home proximity input	Check the axis input information in the Axis Variables to see if the home proximity input sensor turns ON/OFF.	Wire the home proximity input correctly.

Problem	Cause	Item to check	Countermeasure
Operation cannot be started, positioning is not completed, or positioning takes too much time to complete.	The in-position range of the Servo Drive is too narrow, and thus the current position does not enter the in-position range. (The current operation does not complete until the current position enters the in-position range, so you cannot start the next motion.)	---	Increase the in-position range.
	Servo Drive gain is low.	---	Adjust the Servo Drive gain.
	The axis does not remain in the in-position range due to an external force.	Check the axis input information for the Axis Variables to see if the difference between the command current position and the actual current position is within the in-position range.	If you stop the axis so that a position inside the inposition range is not achieved, such as holding control, you can use the following error reset output to forcibly achieve the inposition range.
Abnormal noise	Mechanical vibration	Check the moving parts of the machine for intrusion of foreign matter, damage, deformation, and loosening.	Correct the problem.
	Insufficient adjustment of the Servo Drive gain (high gain)	---	Perform auto-tuning. Manually lower the gain.
	Incorrect Servomotor selection (adjustment not possible).	Select another motor (check the torque and inertia ratio).	Change to an optimal motor.
	Misalignment of the coupling that connects the motor shaft and machine	---	Adjust the motor and machine installation.
Motor shaft shakes.	Insufficient adjustment of the gain (low gain)	---	Perform auto-tuning. Manually increase the gain.
	Gain cannot be adjusted due to low machine rigidity.	In particular, this condition occurs on vertical axes, SCARA robots, palletizers, and other systems whose axes are subject to bending or tensional loads.	Increase the machine rigidity. Readjust the gain.
	Mechanical configuration prone to stick slip (highly sticky static friction)	---	Perform auto-tuning. Manually adjust the gain.
	Incorrect Servomotor selection (adjustment not possible).	Select an appropriate motor (check the torque and inertia ratio).	Change to an optimal motor.

Problem	Cause	Item to check	Countermeasure
	Failure	---	Replace the Servo Drive. Replace the Servomotor.
Position shift	The home position was already shifted before positioning.	Refer to The position of home defined with homing changes occasionally.	Refer to The position of home defined with homing changes occasionally.
	Malfunction due to noise from a welder, inverter, etc.	Check if a welder, inverter, or other similar device is located nearby.	Isolate the Controller from any nearby welders, inverters, etc.
	Mechanical shift	Check if dimensional shifts accumulated. (Mark the mechanical connections to check for shifting.)	Securely tighten the mechanical tightening points.
An MC Test Run is not possible from the Sysmac Studio.	An MC Test Run is being executed from another installation of the Sysmac Studio.	Check to see if there is another installation of the Sysmac Studio connected to the same CPU Unit.	End all MC Test Run operation for other installations of the Sysmac Studio.

3-7 Errors in the EtherNet/IP Function Module

3-7-1 Error Tables

EtherNet/IP

Event code	Event name	Meaning	Assumed cause	Level					Reference
				M a j	P r t	M i n	O b s	I n f o	
04200000 hex [NJ-series]	Communications Controller Error	A hardware error was detected in the communications controller of the built-in EtherNet/IP port.	<ul style="list-style-type: none"> Communications Controller hardware error 		○				page 3-686
14200000 hex [NJ-series]	MAC Address Error	The MAC address in non-volatile memory was not read correctly.	<ul style="list-style-type: none"> Non-volatile memory failure 		○				page 3-686
14220000 hex	EtherNet/IP Processing Error	A fatal error was detected in the EtherNet/IP Function Module.	<ul style="list-style-type: none"> Hardware has failed. 		○				page 3-687
34210000 hex [NJ-series]	Basic Ethernet Setting Error	An error was detected in the Ethernet settings.	<ul style="list-style-type: none"> Setting error Power was interrupted when a download was in progress for the built-in EtherNet/IP port settings. Memory error 		○				page 3-687
34220000 hex [NJ-series]	IP Address Setting Error	An error was detected in the IP address settings.	<ul style="list-style-type: none"> Setting error Power was interrupted when a download was in progress for the built-in EtherNet/IP port settings. The IP address acquired from BOOTP server is illegal. Memory error 		○				page 3-688
84010000 hex [NJ-series]	IP Address Duplication Error	The same IP address is used more than once.	<ul style="list-style-type: none"> The IP address of the built-in EtherNet/IP port is also used as the IP address of another node. 		○				page 3-689
84020000 hex [NJ-series]	BOOTP Server Connection Error	Connection with the BOOTP server failed.	<ul style="list-style-type: none"> Server setting error The server went down. An error occurred in the communications path. 		○				page 3-690

Event code	Event name	Meaning	Assumed cause	Level					Reference
				M a j	P r t	M i n	O b s	I n f o	
04210000 hex (Ver. 1.10 or later) [NX-series]	Communications Controller Error	A hardware error was detected in the communications controller of the built-in EtherNet/IP port.	<ul style="list-style-type: none"> Hardware error in the communications controller 			○			page 3-691
14210000 hex	Identity Error	The CIP identity information in non-volatile memory was not read correctly.	<ul style="list-style-type: none"> Non-volatile memory failure 			○			page 3-692
14230000 hex (Ver. 1.10 or later)	MAC Address Error	The MAC address in non-volatile memory was not read correctly.	<ul style="list-style-type: none"> Non-volatile memory failure 			○			page 3-693
34200000 hex	Tag Data Link Setting Error	An error was detected in the communications settings for tag data links.	<ul style="list-style-type: none"> Power was interrupted when a download was in progress for the data link settings. Memory error 			○			page 3-694
34230000 hex	IP Route Table Setting Error	An IP routing setting error was detected.	<ul style="list-style-type: none"> Setting error Power was interrupted when a download was in progress for the built-in EtherNet/IP port settings. Memory error 			○			page 3-695
34240000 hex	FTP Server Setting Error	An error was detected in the FTP server settings.	<ul style="list-style-type: none"> Setting error Power was interrupted when a download was in progress for the FTP server settings. Memory error 			○			page 3-696
34250000 hex	NTP Client Setting Error	An error was detected in the NTP client settings.	<ul style="list-style-type: none"> Setting error Power was interrupted when a download was in progress for the NTP client settings. Memory error 			○			page 3-697
34260000 hex	SNMP Setting Error	An error was detected in the SNMP agent/trap settings.	<ul style="list-style-type: none"> Setting error Power was interrupted when a download was in progress for the SNMP agent/trap settings. Memory error 			○			page 3-698

Event code	Event name	Meaning	Assumed cause	Level					Reference
				M a j	P r t	M i n	O b s	I n f o	
34270000 hex	Tag Name Resolution Error	Resolution of a tag used in a tag data link failed.	<ul style="list-style-type: none"> The size of the network variable is different from the tag settings. The I/O direction set for a tag data link and the I/O direction of the Controller variable do not match. There are no network variables for the Controller tag settings. A variable in the Controller that is set for a tag data link has the Network Publish attribute set to Input but also has the Constant attribute. 			○			page 3-699
34280000 hex (Ver. 1.10 or later) [NX-series]	Basic Ethernet Setting Error	An error was detected in the Ethernet settings.	<ul style="list-style-type: none"> Parameter error Power was interrupted when a download was in progress for the built-in EtherNet/IP port settings. A memory error occurred. 			○			page 3-700
34290000 hex (Ver. 1.10 or later) [NX-series]	IP Address Setting Error	An error was detected in the IP address settings.	<ul style="list-style-type: none"> Parameter error Power was interrupted when a download was in progress for the built-in EtherNet/IP port settings. The IP address acquired from BOOTP server is illegal. A memory error occurred. 			○			page 3-701
342A0000 hex (Ver. 1.10 or later) [NX-series]	DNS Setting Error	An error was detected in the DNS settings or Hosts settings.	<ul style="list-style-type: none"> Parameter error Power was interrupted when a download was in progress for the built-in EtherNet/IP port settings. A memory error occurred. 			○			page 3-702
342B0000 hex	Link Setting Not Supported	Unsupported LINK settings. The Controller is operating with LINK setting set to Auto.	<ul style="list-style-type: none"> An item other than Auto is selected for LINK settings on the CPU Unit whose hardware revision supports only Auto setting of LINK settings. 			○			page 3-703
50010000 hex (Ver. 1.02 or later)	Controller Insufficient Memory Warning	The amount of data for the EtherCAT slave configuration, network-published information, or other data exceeds the value that is specified for the CPU Unit. You may not be able to perform online editing or other operations.	<ul style="list-style-type: none"> The amount of data for the EtherCAT slave configuration, network-published information, or other data exceeds the value that is specified for the CPU Unit. 			○			page 3-704

Event code	Event name	Meaning	Assumed cause	Level					Reference
				M a j	P r t	M i n	O b s	I n f o	
84030000 hex	DNS Server Connection Error	Connection with the DNS server failed.	<ul style="list-style-type: none"> Parameter error The server went down. An error occurred in the communications path. 			○			page 3-705
84040000 hex	NTP Server Connection Error	Connection with the NTP server failed.	<ul style="list-style-type: none"> Parameter error The server went down. An error occurred in the communications path. 			○	◐		page 3-706
84070000 hex	Tag Data Link Connection Failed	Establishing a tag data link connection failed.	<ul style="list-style-type: none"> The tag data link connection information is not the same for the originator and target. Insufficient connections CIP message communications at the target node are stopped. Setting to use tag data link communications was made to the NX-series EtherNet/IP Unit that is included in the CIP Safety connection settings (for NX-series EtherNet/IP Units). The NX-series EtherNet/IP Unit with tag data link communications was added to the CIP Safety connection settings (for NX-series EtherNet/IP Units). 			○			page 3-707

Event code	Event name	Meaning	Assumed cause	Level					Reference
				M a j	P r t	M i n	O b s	I n f o	
84080000 hex	Tag Data Link Timeout	A timeout occurred in a tag data link.	<ul style="list-style-type: none"> The power supply to the target node is OFF. Communications at the target node are stopped. The Ethernet cable for EtherNet/IP is disconnected. The Ethernet cable for EtherNet/IP is broken. The link to the built-in EtherNet/IP port is OFF. CIP message communications at the target node are stopped. When the Packet Filter function is enabled in the Built-in EtherNet/IP Port Settings, packets from the target are not allowed.*1 CIP communications are not allowed by the Packet Filter (Simple) or Packet Filter functions on the target node or the devices on the communication path. The packet loss occurred on the path due to the network communications load. Noise 					○	page 3-709
84090000 hex (Version 1.04 or later)	Tag Data Link Connection Timeout	A timeout occurred while trying to establish a tag data link connection.	<ul style="list-style-type: none"> The power supply to the target node is OFF. Communications at the target node are stopped. CIP message communications are stopped at the target node or built-in EtherNet/IP port.*1 The Ethernet cable connector for EtherNet/IP is disconnected. The Ethernet cable for EtherNet/IP is broken. CIP communications are not allowed by the Packet Filter (Simple) or Packet Filter functions on the target node or the devices on the communication path. An error occurred in the communications path. 					○ ○	page 3-711
840A0000 hex (Ver. 1.10 or later) [NX-series]	IP Address Duplication Error	The same IP address is used more than once.	<ul style="list-style-type: none"> The IP address of the built-in EtherNet/IP port is also used as the IP address of another node. 					○	page 3-713

Event code	Event name	Meaning	Assumed cause	Level					Reference
				M a j	P r t	M i n	O b s	I n f o	
840B0000 hex (Ver. 1.10 or later) [NX-series]	BOOTP Server Con- nection Error	Connection with the BOOTP server failed.	<ul style="list-style-type: none"> Server setting error The server went down. An error occurred in the com- munications path. 			○			page 3-714
840C0000 hex (Ver. 1.10 or later) [NX-series]	Allowed Communica- tions Band- width per Unit Exceed- ed	The total bandwidth for the connections that are set or estab- lished exceeded the allowed communica- tions bandwidth of tag data links and CIP Safety communica- tions per Unit for all of the built-in EtherNet/IP ports.	<ul style="list-style-type: none"> An attempt was made to es- tablish a connection that would cause the used bandwidth (PPS) total of the packet trans- fer rates of the tag data links and CIP Safety communica- tions that use all of the built-in EtherNet/IP ports to exceed the allowed communications bandwidth per Unit. 			○			page 3-715
840E0000 hex	Number of Tag Sets for Tag Data Links Ex- ceeded	The total number of tag sets for tag data links for all ports of the built-in Ethernet/IP port ex- ceeds the upper limit.	<ul style="list-style-type: none"> The total number for all ports of tag sets for tag data links that are set for each built-in Ethernet/IP port exceeds the total number the product al- lows. 			○			page 3-716
54E00000 hex	Access De- tected Out- side Range of Variable	Accessing a value that is out of range was detected for a tag variable that is used in a tag data link.	<ul style="list-style-type: none"> An out-of-range value was written by an EtherNet/IP tag data link for a variable with a specified range. A value that does not specify an enumera- tor was written by an EtherNet/IP tag data link for an enumeration variable. 				○		page 3-717
84050000 hex	Packet Dis- carded Due to Full Re- ception Buf- fer	A packet was dis- carded.	<ul style="list-style-type: none"> A network convergence occur- red. 				○		page 3-718
84060000 hex	Link OFF Detected	An Ethernet link OFF was detected.	<ul style="list-style-type: none"> An Ethernet cable is broken, disconnected, or loose. The Ethernet switch's power supply is turned OFF. Communications speed mis- matched. Noise The Identity object was reset. Settings for EtherNet/IP were downloaded from the Network Configurator or Sysmac Stu- dio, or the Clear All Memory operation was performed. EtherNet/IP was restarted. If an Ethernet link off is detect- ed on port 2, the Use Port 2 check box is not selected. 			○	○		page 3-719

Event code	Event name	Meaning	Assumed cause	Level					Reference
				M a j	P r t	M i n	O b s	I n f o	
840F0000 hex (Ver. 1.60 or later) [NX502-1□□□]	DHCP Server Connection Error	Connection to the DHCP server failed.	<ul style="list-style-type: none"> The server is misconfigured. The server went down. Abnormalities occurred in the communication path. 				○		page 3-720
940F0000 hex (Ver. 1.46 or later) [NX102-□□00, NX1P2-□□□□□□] (Ver. 1.37 or later) [NX102-□□20] (Ver. 1.60 or later) [NX502-1□□□]	Secure Socket Communications Log Saving Failed	Secure socket communications log could not be saved to the SD Memory Card.	<ul style="list-style-type: none"> An SD Memory Card is not inserted. The SD Memory Card type is not correct. The SD Memory Card format is invalid. The SD Memory Card is write protected. The SD Memory Card does not have sufficient available space. The SD Memory Card is damaged. 				○		page 3-721
94010000 hex	Tag Data Link Download Started	Changing the tag data link settings started.	<ul style="list-style-type: none"> Changing the tag data link settings started. 					○	page 3-722
94020000 hex	Tag Data Link Download Finished	Changing the tag data link settings finished.	<ul style="list-style-type: none"> Changing the tag data link settings finished. 					○	page 3-723
94030000 hex	Tag Data Link Stopped	Tag data links were stopped by the Network Configurator, Sysmac Studio, special instructions or manipulation of a system-defined variable. Or, the data link table was downloaded from Network Configurator or Sysmac Studio.	<ul style="list-style-type: none"> Tag data links were stopped by the Network Configurator, Sysmac Studio, special instructions or manipulation of a system-defined variable. 					○	page 3-724
94040000 hex	Tag Data Link Started	Tag data links were started by the Network Configurator, Sysmac Studio, special instructions or manipulation of a system-defined variable. Or, the data link table was downloaded from Network Configurator or Sysmac Studio.	<ul style="list-style-type: none"> Tag data links were started by the Network Configurator, Sysmac Studio, special instructions or manipulation of a system-defined variable. 					○	page 3-725
94050000 hex	Link Detected	Establishment of an Ethernet link was detected.	<ul style="list-style-type: none"> Establishment of an Ethernet link was detected. 					○	page 3-726

Event code	Event name	Meaning	Assumed cause	Level					Reference
				M a j	P r t	M i n	O b s	I n f o	
94060000 hex	Restarting Ethernet Port	The built-in EtherNet/IP port was restarted.	• The built-in EtherNet/IP port was restarted.					○	page 3-726
94070000 hex	Tag Data Link All Run	Tag data link connections to all nodes have been normally established.	• Tag data link connections to all target nodes have been normally established.					○	page 3-727
94080000 hex	IP Address Fixed	The correct IP address has been determined and Ethernet communications can start.	• The correct IP address has been determined and Ethernet communications can start.					○	page 3-728
94090000 hex	BOOTP Client Started	The BOOTP client started requesting an IP address.	• The BOOTP client started requesting an IP address.					○	page 3-728
940A0000 hex	FTP Server Started	The FTP agent started normally.	• The FTP agent started normally.					○	page 3-729
940B0000 hex	NTP Client Started	The NTP client started normally and a request for the NTP server to obtain the time started.	• The NTP client started normally and a request for the NTP server to obtain the time started.					○	page 3-729
940C0000 hex	SNMP Started	The SNMP agent started normally.	• The SNMP agent started normally.					○	page 3-730
940E0000 hex (Ver. 1.46 or later) [NX102-□□00, NX1P2-□□□□□□] (Ver. 1.37 or later) [NX102-□□20] (Ver.1.60 or later) [NX502-1□□□]	Secure Socket Communications Log Started/ Stopped	Secure socket communications logging has started or stopped.	Secure socket communications logging has started or stopped.					○	page 3-730
94100000 hex (Ver.1.46 or later and Ver.1.48 or earlier) [NX102-□□00, NX1P2-□□□□□□] (Ver. 1.37 or later) [NX102-□□20] (Ver.1.60 or later) [NX502-1□□□]	Access to Secure Socket Setting	Settings have been changed or read from the Secure Socket Settings dialog box.	Settings have been changed or read from the Secure Socket Settings dialog box.					○	page 3-731
94110000 hex (Ver. 1.49 or later) [NX102-□□00, NX1P2-□□□□□□, and NX102-□□20] (Ver. 1.60 or later) [NX502-1□□□]	Access to Secure Socket Setting	Secure socket setting was changed or read.	Secure socket setting was changed or read.					○	page 3-732

Event code	Event name	Meaning	Assumed cause	Level					Reference
				M a j	P r t	M i n	O b s	I n f o	
94120000 hex (Ver. 1.49 or later) [NX102-□□00, NX1P2- □□□□□□, and NX102-□□20] (Ver. 1.60 or later) [NX502-1□□□]	Change or Reading of Secure Socket Set- ting	Secure socket setting was changed or read.	Secure socket setting was changed or read.					○	page 3-733
94130000 hex (Ver. 1.49 or later) [NJ-series, NX102, NX1P2] (Ver. 1.60 or later) [NX502] (Ver. 1.29 or later) [NX701]	IP Address Changed	The IP address was changed.	The IP address was changed.					○	page 3-734
94140000 hex (Ver. 1.49 or later) [NJ-series, NX102, NX1P2] (Ver. 1.60 or later) [NX502] (Ver. 1.29 or later) [NX701]	SNMP Set- tings Changed	SNMP Settings were changed.	SNMP Settings were changed.					○	page 3-735
94150000 hex (Ver. 1.49 or later) [NJ-series, NX102, NX1P2] (Ver. 1.60 or later) [NX502] (Ver. 1.29 or later) [NX701]	Subnet Mask Changed	The subnet mask was changed.	The subnet mask was changed.					○	page 3-736
96450000 hex	Restarting Ethernet Port	The EtherNet/IP port was restarted.	The EtherNet/IP port was restart- ed.					○	page 3-736

- *1. Assumed cause for the following CPU Units.
- NJ-series, NX102, NX1P2 CPU Unit: Version 1.49 or later
 - NX502 CPU Unit: Version 1.60 or later
 - NX701 CPU Unit: Version 1.29 or later

3-7-2 Error Descriptions

EtherNet/IP

Event name	Communications Controller Error		Event code	04200000 hex		
Meaning	A hardware error was detected in the communications controller of the built-in EtherNet/IP port.					
Source	EtherNet/IP Function Module		Source details	Communica- tions port	Detection tim- ing	Continuously
Error attributes	Level	Partial fault	Recovery	Cycle the power supply.	Log category	System
Effects	User program	Continues.	Operation	EtherNet/IP communications will not operate.		
Indicators	EtherNet/IP NET RUN		EtherNet/IP NET ERR		EtherNet/IP LINK/ACT	
	OFF		Lights.		---	
System-de- fined variables	Variable		Data type		Name	
	_EIP_LanHwErr		BOOL		Communications Controller Error	
Cause and cor- rection	Assumed cause		Correction		Prevention	
	Communications Controller hard- ware error		Replace the CPU Unit.		None	
Attached infor- mation	None					
Precautions/ Remarks	After the _EIP_LanHwErr system-defined variable changes to TRUE, it will not change to FALSE unless the power supply to the Controller is cycled.					

Event name	MAC Address Error		Event code	14200000 hex		
Meaning	The MAC address in non-volatile memory was not read correctly.					
Source	EtherNet/IP Function Module		Source details	Communica- tions port	Detection tim- ing	At power ON or Controller reset
Error attributes	Level	Partial fault	Recovery	Cycle the power supply.	Log category	System
Effects	User program	Continues.	Operation	EtherNet/IP communications will not operate.		
Indicators	EtherNet/IP NET RUN		EtherNet/IP NET ERR		EtherNet/IP LINK/ACT	
	OFF		Lights.		---	
System-de- fined variables	Variable		Data type		Name	
	_EIP_MacAdrErr		BOOL		MAC Address Error	
Cause and cor- rection	Assumed cause		Correction		Prevention	
	Non-volatile memory failure		Replace the CPU Unit.		None	
Attached infor- mation	None					
Precautions/ Remarks	After the _EIP_MacAdrErr system-defined variable changes to TRUE, it will not change to FALSE unless the power supply to the Controller is cycled.					

Event name	EtherNet/IP Processing Error			Event code	14220000 hex	
Meaning	A fatal error was detected in the EtherNet/IP Function Module.					
Source	EtherNet/IP Function Module		Source details	Communications port	Detection timing	Continuously
Error attributes	Level	Partial fault	Recovery	Cycle the power supply.	Log category	System
Effects	User program	Continues.	Operation	EtherNet/IP communications will not operate.		
Indicators	EtherNet/IP NET RUN		EtherNet/IP NET ERR		EtherNet/IP LINK/ACT	
	OFF		Lights.		---	
System-defined variables	Variable		Data type		Name	
	None		---		---	
Cause and correction	Assumed cause		Correction		Prevention	
	Hardware has failed.		Replace the CPU Unit.		None	
Attached information	Attached information 1: System information Attached information 2: System information Attached information 3: System information Attached information 4: System information					
Precautions/Remarks	None					

Event name	Basic Ethernet Setting Error			Event code	34210000 hex	
Meaning	An error was detected in the Ethernet settings.					
Source	EtherNet/IP Function Module		Source details	Communications port	Detection timing	At power ON or Controller reset
Error attributes	Level	Partial fault	Recovery	Automatic recovery, cycle the power supply, or reset the Controller.	Log category	System
Effects	User program	Continues.	Operation	EtherNet/IP communications will not operate.		
Indicators	EtherNet/IP NET RUN		EtherNet/IP NET ERR		EtherNet/IP LINK/ACT	
	OFF		Flashes at 1-s intervals.		---	
System-defined variables	Variable		Data type		Name	
	_EIP_EtnCfgErr		BOOL		Basic Ethernet Setting Error	
Cause and correction	Assumed cause		Correction		Prevention	
	Setting error		Identify the error from the attached information, correct the setting, and then download the settings again.		None	
	Power was interrupted when a download was in progress for the built-in EtherNet/IP port settings.		Perform the Clear All Memory operation or download the settings.		Do not turn OFF the power supply to the Controller while a download is in progress for the built-in EtherNet/IP port settings.	
	Memory error		If operation is not recovered by the above, replace the CPU Unit.		None	
Attached information	Attached information 1: Type of errors (01 hex: Non-volatile memory access error, 02 hex: Inconsistency in settings) Attached information 2: Error details (00 hex: Non-volatile memory access error, 11 hex: Incorrect baud rate setting, 12 hex: Unsupported baud rate)					
Precautions/Remarks	The cause of error can be identified with the attached information.					

3 Error Descriptions and Corrections

Event name	IP Address Setting Error		Event code	34220000 hex		
Meaning	An error was detected in the IP address settings.					
Source	EtherNet/IP Function Module		Source details	Communica- tions port	Detection tim- ing	At power ON or Controller reset
Error attributes	Level	Partial fault	Recovery	Automatic re- covery (after downloading the settings), cycle the power sup- ply, or reset Controller.	Log category	System
Effects	User program	Continues.	Operation	EtherNet/IP communications will not operate.		
Indicators	EtherNet/IP NET RUN		EtherNet/IP NET ERR		EtherNet/IP LINK/ACT	
	OFF		Flashes at 1-s intervals.		---	
System-de- fined variables	Variable		Data type		Name	
	_EIP_IPAdrCfgErr		BOOL			
Cause and cor- rection	Assumed cause	Correction	Prevention			
	Setting error	Identify the error from the attached information, correct the setting, and then download the settings again.	None			
	Power was interrupted when a download was in progress for the built-in EtherNet/IP port settings.	Perform the Clear All Memory operation or download the settings again.	Do not turn OFF the power supply to the Controller while a download is in progress for the built-in EtherNet/IP port settings.			
	The IP address acquired from BOOTP server is illegal.	Correct the IP address that was provided to this port by the BOOTP server so that it is within the range specified for an NJ-series Controller.	Set the IP address that was provided to this port by the BOOTP server so that it is within the range specified for an NJ-series Controller.			
	Memory error	If operation is not recovered by the above, replace the CPU Unit.	None			
Attached infor- mation	Attached information 1: Type of errors (01 hex: Non-volatile memory access error, 02 hex: Inconsistency in settings) Attached information 2: Error details (00 hex: Non-volatile memory access error When the settings are inconsistent (11 hex: Illegal IP address, 12 hex: Illegal subnet mask, 13 hex: Illegal default gateway, 14 hex: Preferred DNS setting error, 15 hex: Alternate DNS setting error, 16 hex: Illegal domain name)					
Precautions/ Remarks	The cause of error can be identified with the attached information.					

Event name	IP Address Duplicated		Event code	84010000 hex		
Meaning	The same IP address is used more than once.					
Source	EtherNet/IP Function Module		Source details	Communica- tions port	Detection tim- ing	After link is es- tablished
Error attributes	Level	Partial fault	Recovery	Automatic re- covery (after downloading the IP address set- tings), cycle the power supply, or reset Controller.	Log category	System
Effects	User program	Continues.	Operation	EtherNet/IP communications will not operate. Packets addressed to the local IP address are discarded.		
Indicators	EtherNet/IP NET RUN		EtherNet/IP NET ERR		EtherNet/IP LINK/ACT	
	OFF		Flashes at 1-s intervals.		---	
System-de- fined variables	Variable		Data type		Name	
	_EIP_IPAdrDupErr		BOOL		IP Address Duplication Error	
Cause and cor- rection	Assumed cause		Correction		Prevention	
	The IP address of the built-in EtherNet/IP port is also used as the IP address of another node.		Perform either of the following corrections. <ul style="list-style-type: none"> • Check the IP addresses of other nodes and correct the IP address settings so that the same address is not used by more than one node. • Remove the other node that has the duplicate IP address from the network and then cycle the power supply to the Controller or reset the Controller. 		Perform allocations so that IP addresses of nodes on the network are used for only one node.	
Attached infor- mation	Attached information 1: Duplicated IP address (example: C0A8FA01 hex = address 192.168.250.1)					
Precautions/ Remarks	A duplicated address error occurs if an ARP is sent with the set IP address and there is an ARP response.					

Event name	BOOTP Server Connection Error		Event code	84020000 hex		
Meaning	Connection with the BOOTP server failed.					
Source	EtherNet/IP Function Module		Source details	Communica- tions port	Detection tim- ing	At BOOTP oper- ation
Error attributes	Level	Partial fault	Recovery	Automatic re- covery	Log category	System
Effects	User program	Continues.	Operation	EtherNet/IP communications will not operate. Requests to the BOOTP server will continue until there is a response from the BOOTP server. Data re- freshing with the PLC Function Module will continue. An IP address was not set for the EtherNet/IP port when it was supposed to be set from the BOOTP server.		
Indicators	EtherNet/IP NET RUN		EtherNet/IP NET ERR		EtherNet/IP LINK/ACT	
	OFF		Flashes at 1-s intervals.		---	
System-de- fined variables	Variable		Data type		Name	
	_EIP_BootpErr		BOOL		BOOTP Server Error	
Cause and cor- rection	Assumed cause		Correction		Prevention	
	Server setting error		Correct the server settings at the remote connection.		Check to make sure that the server settings at the remote connection are correct.	
	Server is down.		Check if the server at the remote connection is operating normally and set it to operate normally if it is not.		Check to make sure that the server at the remote connection is operating normally.	
	An error occurred in the communi- cations path.		Check the communications path to the server and take corrective measures if there are any prob- lems.		None	
Attached infor- mation	None					
Precautions/ Remarks	None					

Event name	Communications Controller Error		Event code	04210000 hex*1	
Meaning	A hardware error was detected in the communications controller of the built-in EtherNet/IP port.				
Source	EtherNet/IP Function Module		Source details	Communications port 1 or 2	Detection timing Continuously
Error attributes	Level	Minor fault	Recovery	Cycle the power supply.	Log category System
Effects	User program	Continues.	Operation	EtherNet/IP communications are not possible for the relevant communications port.	
Indicators	EtherNet/IP NET RUN		EtherNet/IP NET ERR		EtherNet/IP LINK/ACT
	OFF		Lights.		---
System-defined variables	Variable		Data type		Name
	_EIP1_LanHwErr		BOOL		Port1 Communications Controller Error
	_EIP2_LanHwErr		BOOL		Port2 Communications Controller Error
Cause and correction	Assumed cause		Correction		Prevention
	Hardware error in the communications controller		Replace the CPU Unit.		None
Attached information	None				
Precautions/Remarks	After the _EIP1_LanHwErr or _EIP2_LanHwErr system-defined variable changes to TRUE, it will not change to FALSE unless the power supply to the Controller is cycled.				

*1. This event code occurs for a CPU Unit with unit version 1.10 or later.

Event name	Identity Error		Event code	14210000 hex		
Meaning	The CIP identity information in non-volatile memory was not read correctly.					
Source	In the CPU Unit, EtherNet/IP Function Module. For the X Bus Unit, X Bus Ethernet/IP Function Module	Source details	CIP ^{*1} /CIP1 ^{*2} / CIP2 ^{*2} /1 to 4: <i>Mounting position of the X Bus Unit and CIP1 /CIP2 are given in combination.*4</i>	Detection timing	At power ON or Controller reset	
Error attributes	Level	Minor fault	Recovery	Cycle the power supply.	Log category	System
Effects	User program	Continues.	Operation	EtherNet/IP communications are not possible for the relevant communications port.		
Indicators	EtherNet/IP NET RUN		EtherNet/IP NET ERR		EtherNet/IP LINK/ACT	
	---		Lights.		---	
System-defined variable	Variable	Data type	Name			
	_EIP_IdentityErr ^{*1} ^{*3}	BOOL	Identity Error			
	_EIP1_IdentityErr ^{*2} ^{*3}	BOOL	CIP Communications1 Identity Error			
	_EIP2_IdentityErr ^{*2} ^{*3}	BOOL	CIP Communications2 Identity Error			
	EIP_Comm1Status.IdentityErr ^{*4}	BOOL	CIP Communications1 Identity Error			
	EIP_Comm2Status.IdentityErr ^{*4}	BOOL	CIP Communications2 Identity Error			
Cause and correction	Assumed cause		Correction		Prevention	
	Non-volatile memory failure		Replace the CPU Unit.		None	
Attached information	None					
Precautions/Remarks	None					

*1. This applies to an NJ-series CPU Unit.

*2. This applies to an NX-series CPU Unit.

*3. This applies to a Unit other than NX-series EtherNet/IP Unit.

*4. This applies to an NX-series EtherNet/IP Unit.

Event name	MAC Address Error		Event code	14230000 hex*1		
Meaning	The MAC address in non-volatile memory was not read correctly.					
Source	EtherNet/IP Function Module		Source details	Communica- tions port 1 or 2	Detection tim- ing	At power ON or Controller reset
Error attributes	Level	Minor fault	Recovery	Cycle the power supply.	Log category	System
Effects	User program	Continues.	Operation	EtherNet/IP communications are not possible for the relevant communications port.		
Indicators	EtherNet/IP NET RUN		EtherNet/IP NET ERR		EtherNet/IP LINK/ACT	
	OFF		Lights.		---	
System-de- fined variables	Variable		Data type		Name	
	_EIP1_MacAdrErr		BOOL		Port 1 MAC Address Error	
	_EIP2_MacAdrErr		BOOL		Port2 MAC Address Error	
Cause and cor- rection	Assumed cause		Correction		Prevention	
	Non-volatile memory failure		Replace the CPU Unit.		None	
Attached infor- mation	None					
Precautions/ Remarks	After the _EIP1_MacAdrErr or _EIP2_MacAdrErr system-defined variable changes to TRUE, it will not change to FALSE unless the power supply to the Controller is cycled.					

*1. This event code occurs for unit version 1.10 or later of the CPU Unit.

Event name	Tag Data Link Setting Error		Event code	34200000 hex		
Meaning	An error was detected in the communications settings for tag data links.					
Source	In the CPU Unit, EtherNet/IP Function Module. For the X Bus Unit, X Bus Ethernet/IP Function Module	Source details	CIP ^{*1} /CIP1 ^{*2} / CIP2 ^{*2} /1 to 4: <i>Mounting position of the X Bus Unit and CIP1 /CIP2 are given in combination.*4</i>	Detection timing	At power ON or Controller reset	
Error attributes	Level	Minor fault	Recovery	Automatic recovery (after downloading the tag data link settings), cycle the power supply, or reset Controller.	Log category	System
Effects	User program	Continues.	Operation	Tag data link communications will not operate.		
Indicators	EtherNet/IP NET RUN		EtherNet/IP NET ERR		EtherNet/IP LINK/ACT	
	Flashes at 1-s intervals.		Flashes at 1-s intervals.		---	
System-defined variable	Variable	Data type	Name			
	_EIP_TDLINKCfgErr ^{*1} ^{*3}	BOOL	Tag Data Link Setting Error			
	_EIP1_TDLINKCfgErr ^{*2} ^{*3}	BOOL	CIP Communications1 Tag Data Link Setting Error			
	_EIP2_TDLINKCfgErr ^{*2} ^{*3}	BOOL	CIP Communications2 Tag Data Link Setting Error			
	EIP_Comm1Status.TDLINKCfgErr ^{*4}	BOOL	CIP Communications1 Tag Data Link Setting Error			
	EIP_Comm2Status.TDLINKCfgErr ^{*4}	BOOL	CIP Communications2 Tag Data Link Setting Error			
Cause and correction	Assumed cause	Correction		Prevention		
	Power was interrupted when a download was in progress for the data link settings.	Implement one of the following measures. • Clear All Memory • Download the tag data link settings again. • Clear the tag data link settings.		Do not turn OFF the power supply to the Controller while a download is in progress for the tag data link settings.		
	Memory error	If the above measures do not work, replace the CPU Unit.		None		
Attached information	Attached information 1: Type of errors (01 hex: Non-volatile memory access error, 02 hex: Inconsistency in settings)					
Precautions/Remarks	None					

*1. This applies to an NJ-series CPU Unit.

*2. This applies to an NX-series CPU Unit.

*3. This applies to a unit other than NX-series EtherNet/IP Unit.

*4. This applies to an NX-series EtherNet/IP Unit.

Event name	IP Rout Table Setting Error		Event code	34230000 hex	
Meaning	An IP routing setting error was detected.				
Source	EtherNet/IP Function Module		Source details	Communications port	Detection timing At power ON or Controller reset
Error attributes	Level	Minor fault	Recovery	Automatic recovery (after downloading the settings), cycle the power supply, or reset Controller.	Log category System
Effects	User program	Continues.	Operation	Communications that use the relevant IP routing settings are not possible.	
Indicators	EtherNet/IP NET RUN		EtherNet/IP NET ERR		EtherNet/IP LINK/ACT
	---		Flashes at 1-s intervals.		---
System-defined variables	Variable		Data type		Name
	_EIP_IPRTblErr		BOOL		IP Route Table Error
Cause and correction	Assumed cause		Correction		Prevention
	Setting error		Identify the error from the attached information, correct the setting, and then download the settings again.		None
	Power was interrupted when a download was in progress for the built-in EtherNet/IP port settings.		Perform the Clear All Memory operation or download the settings again.		Do not turn OFF the power supply to the Controller while a download is in progress for the built-in EtherNet/IP port settings.
	Memory error		If operation is not recovered by the above, replace the CPU Unit.		None
Attached information	Attached information 1: Type of errors (01 hex: Non-volatile memory access error, 02 hex: Inconsistency in settings) Attached information 2: Error Details (00 hex: Non-volatile memory access error When the settings are inconsistent (11 hex: Illegal IP router table settings, 12 hex: Illegal Hosts setting, 13 hex: Invalid default gateway, 14 hex: Illegal IPForward settings, 15 hex: Illegal NAT settings, 16 hex: Illegal PacketFilter settings)				
Precautions/Remarks	The cause of error can be identified with the attached information.				

Event name	FTP Server Setting Error		Event code	34240000 hex		
Meaning	An error was detected in the FTP server settings.					
Source	EtherNet/IP Function Module		Source details	FTP	Detection timing	At power ON or Controller reset
Error attributes	Level	Minor fault	Recovery	Automatic recovery (after downloading the FTP settings), cycle the power supply, or reset Controller	Log category	System
Effects	User program	Continues.	Operation	FTP will not operate.		
Indicators	EtherNet/IP NET RUN		EtherNet/IP NET ERR		EtherNet/IP LINK/ACT	
	---		Flashes at 1-s intervals.		---	
System-defined variables	Variable		Data type		Name	
	None		---		---	
Cause and correction	Assumed cause		Correction		Prevention	
	Setting error		Identify the error from the attached information, correct the setting, and then download the settings again.		None	
	Power was interrupted when a download was in progress for the FTP server settings.		Perform the Clear All Memory operation or download the settings again.		Do not turn OFF the power supply to the Controller while a download is in progress for the FTP server settings.	
	Memory error		If operation is not recovered by the above, replace the CPU Unit.		None	
Attached information	Attached information 1: Type of errors (01 hex: Non-volatile memory access error, 02 hex: Inconsistency in settings)					
Precautions/Remarks	The cause of error can be identified with the attached information.					

Event name	NTP Client Setting Error		Event code	34250000 hex	
Meaning	An error was detected in the NTP client settings.				
Source	EtherNet/IP Function Module		Source details	NTP	Detection timing At power ON or Controller reset
Error attributes	Level	Minor fault	Recovery	Automatic recovery (after downloading the NTP settings), cycle the power supply, or reset Controller	Log category System
Effects	User program	Continues.	Operation	NTP operation stops.	
Indicators	EtherNet/IP NET RUN		EtherNet/IP NET ERR		EtherNet/IP LINK/ACT
	---		Flashes at 1-s intervals.		---
System-defined variables	Variable		Data type		Name
	None		---		---
Cause and correction	Assumed cause		Correction		Prevention
	Setting error		Identify the error from the attached information, correct the setting, and then download the settings again.		None
	Power was interrupted when a download was in progress for the NTP client settings.		Perform the Clear All Memory operation or download the settings again.		Do not turn OFF the power supply to the Controller while a download is in progress for the NTP client settings.
	Memory error		If operation is not recovered by the above, replace the CPU Unit.		None
Attached information	Attached information 1: Type of errors (01 hex: Non-volatile memory access error, 02 hex: Inconsistency in settings)				
Precautions/Remarks	The cause of error can be identified with the attached information.				

Event name	SNMP Setting Error		Event code	34260000 hex	
Meaning	An error was detected in the SNMP agent/trap settings.				
Source	EtherNet/IP Function Module		Source details	SNMP	Detection timing At power ON or Controller reset
Error attributes	Level	Minor fault	Recovery	Automatic recovery (after downloading the SNMP settings), cycle the power supply, or reset Controller	Log category System
Effects	User program	Continues.	Operation	SNMP operation stops.	
Indicators	EtherNet/IP NET RUN		EtherNet/IP NET ERR		EtherNet/IP LINK/ACT
	---		Flashes at 1-s intervals.		---
System-defined variables	Variable		Data type		Name
	None		---		---
Cause and correction	Assumed cause		Correction		Prevention
	Setting error		Identify the error from the attached information, correct the setting, and then download the settings again.		None
	Power was interrupted when a download was in progress for the SNMP agent/trap settings.		Perform the Clear All Memory operation or download the settings again.		Do not turn OFF the power supply to the Controller while a download is in progress for the SNMP agent/trap settings.
	Memory error		If operation is not recovered by the above, replace the CPU Unit.		None
Attached information	Attached information 1: Type of errors (01 hex: Non-volatile memory access error, 02 hex: Inconsistency in settings) Attached Information 2: Error Location When the settings are inconsistent (01 hex: SNMP agent settings, 02 hex: SNMP trap settings)				
Precautions/Remarks	The cause of error can be identified with the attached information.				

Event name	Tag Name Resolution Error		Event code	34270000 hex		
Meaning	Resolution of a tag used in a tag data link failed.					
Source	In the CPU Unit, EtherNet/IP Function Module. For the X Bus Unit, X Bus Ethernet/IP Function Module	Source details	CIP *1/CIP1 *2/ CIP2 *2/1 to 4: <i>Mounting position of the X Bus Unit</i> and CIP1 /CIP2 are given in combination.*4	Detection timing	At power ON, at Controller reset, when variables are changed from the Sysmac Studio, or when the data link table is changed from the Network Configurator	
Error attributes	Level	Minor fault	Recovery	Automatic recovery (after downloading the tag settings)	Log category	System
Effects	User program	Continues.	Operation	Data links will not operate for unresolved tags. Data links for other tags will operate.		
Indicators	EtherNet/IP NET RUN		EtherNet/IP NET ERR		EtherNet/IP LINK/ACT	
	Flashes at 1-s intervals.		Flashes at 1-s intervals.		---	
System-defined variable	Variable	Data type	Name			
	_EIP_TagAdrErr *1 *3	BOOL	Tag Name Resolution Error			
	_EIP1_TagAdrErr *2 *3	BOOL	CIP Communications1 Tag Name Resolution Error			
	_EIP2_TagAdrErr *2 *3	BOOL	CIP Communications2 Tag Name Resolution Error			
	EIP_Comm1Status.TagAdrErr *4	BOOL	CIP Communications1 Tag Name Resolution Error			
	EIP_Comm2Status.TagAdrErr *4	BOOL	CIP Communications2 Tag Name Resolution Error			
Cause and correction	Assumed cause	Correction	Prevention			
	The size of the network variable is different from the tag settings.	Correct the sizes in the tag settings to match the network variables.	Set the sizes in the tag settings to match the network variables.			
	The I/O direction set for a tag data link and the I/O direction of the Controller variable do not match.	Correct the tag settings or the settings of the Controller variables so that the I/O direction for the tag data links match the I/O direction of the Controller variables.	Set the tag settings or the settings of the Controller variables so that the I/O directions for the tag data links match the I/O directions of the Controller variables.			
	There are no network variables for the Controller tag settings.	Correct the tag settings so that existing network variables are set for the tags.	Set the tag settings so that existing network variables are set for the tags.			
	A variable in the Controller that is set for a tag data link has the Network Publish attribute set to Input but also has the Constant attribute.	Remove the Constant attribute from the Controller variable that has the Network Publish attribute set to Input .	Do not set the Constant attribute for a Controller variable that has the Network Publish attribute set to Input .			
Attached information	None					
Precautions/Remarks	None					

*1. This applies to an NJ-series CPU Unit.

*2. This applies to an NX-series CPU Unit.

*3. This applies to a unit other than NX-series EtherNet/IP Unit.

*4. This applies to an NX-series EtherNet/IP Unit.

Event name	Basic Ethernet Setting Error		Event code	34280000 hex ^{*1}		
Meaning	An error was detected in the Ethernet settings.					
Source	EtherNet/IP Function Module		Source details	Communications port 1 or 2	Detection timing	At power ON or Controller reset
Error attributes	Level	Minor fault	Recovery	Automatic recovery, cycle the power supply, or reset the Controller.	Log category	System
Effects	User program	Continues.	Operation	EtherNet/IP communications are not possible for the relevant communications port.		
Indicators	EtherNet/IP NET RUN		EtherNet/IP NET ERR		EtherNet/IP LINK/ACT	
	OFF		Flashes at 1-s intervals.		---	
System-defined variables	Variable		Data type		Name	
	_EIP1_EtnCfgErr		BOOL		Port1 Basic Ethernet Setting Error	
	_EIP2_EtnCfgErr		BOOL		Port2 Basic Ethernet Setting Error	
Cause and correction	Assumed cause		Correction		Prevention	
	Setting error		Identify the error from the attached information, correct the setting, and then download the settings again.		None	
	Power was interrupted when a download was in progress for the built-in EtherNet/IP port settings.		Perform the Clear All Memory operation or download the settings.		Do not turn OFF the power supply to the Controller while a download is in progress for the built-in EtherNet/IP port settings.	
	Memory error		If operation is not recovered by the above, replace the CPU Unit.		None	
Attached information	Attached information 1: Type of errors (01 hex: Non-volatile memory access error, 02 hex: Inconsistency in settings) Attached information 2: Error details (00 hex: Non-volatile memory access error, 11 hex: Incorrect baud rate setting, 12 hex: Unsupported baud rate)					
Precautions/Remarks	The cause of error can be identified with the attached information.					

*1. This event code occurs for unit version 1.10 or later of the CPU Unit.

Event name	IP Address Setting Error		Event code	34290000 hex*1		
Meaning	An error was detected in the IP address settings.					
Source	EtherNet/IP Function Module		Source details	Communications port 1 or 2, or Internal port 1	Detection timing	At power ON, at Controller reset, or at user operation
Error attributes	Level	Minor fault	Recovery	Automatic recovery (after downloading the settings), cycle the power supply, or reset Controller.	Log category	System
Effects	User program	Continues.	Operation	EtherNet/IP communications are not possible for the relevant communications port.		
Indicators	EtherNet/IP NET RUN		EtherNet/IP NET ERR		EtherNet/IP LINK/ACT	
	OFF		Flashes at 1-s intervals.		---	
System-defined variable	Variable		Data type		Name	
	_EIP1_IPAdrCfgErr		BOOL		Port1 IP Address Setting Error	
	_EIP2_IPAdrCfgErr		BOOL		Port2 IP Address Setting Error	
	_EIPIn1_IPAdrCfgErr		BOOL		Internal Port1 IP Address Setting Error	
Cause and correction	Assumed cause		Correction		Prevention	
	Setting error		Identify the error from the attached information, correct the setting, and then download the settings again.		None	
	Power was interrupted when a download was in progress for the built-in EtherNet/IP port settings.		Perform the Clear All Memory operation or download the settings again.		Do not turn OFF the power supply to the Controller while a download is in progress for the built-in EtherNet/IP port settings.	
	The IP address acquired from BOOTP server is illegal.		Correct the IP address that was provided to this port by the BOOTP server so that it is within the range specified for an NX-series Controller.		Set the IP address that was provided to this port by the BOOTP server so that it is within the range specified for an NX-series Controller.	
	Memory error		If operation is not recovered by the above replace the CPU Unit.		None	
Attached information	Attached information 1: Type of errors (01 hex: Non-volatile memory access error, 02 hex: Inconsistency in settings) Attached information 2: Error Details (00 hex: Non-volatile memory access error When the settings are inconsistent (11 hex: Illegal IP address, 12 hex: Illegal subnet mask)					
Precautions/Remarks	The cause of error can be identified with the attached information.					

*1. This event code occurs for unit version 1.10 or later of the CPU Unit.

Event name	DNS Setting Error		Event code	342A0000 hex *1		
Meaning	An error was detected in the DNS settings or Hosts settings.					
Source	EtherNet/IP Function Module		Source details	Communica- tions port	Detection tim- ing	At power ON or Controller reset
Error attributes	Level	Minor fault	Recovery	Automatic re- covery (after downloading the settings), cycle the power sup- ply, or reset Controller.	Log category	System
Effects	User program	Continues.	Operation	EtherNet/IP communications will not operate.		
Indicators	EtherNet/IP NET RUN		EtherNet/IP NET ERR		EtherNet/IP LINK/ACT	
	OFF		Flashes at 1-s intervals.		---	
System-de- fined variables	Variable	Data type	Name			
	_EIP_DNSCfgErr	BOOL	DNS Setting Error			
Cause and cor- rection	Assumed cause		Correction		Prevention	
	Setting error		Identify the error from the attached information, correct the setting, and then download the settings again.		None	
	Power was interrupted when a download was in progress for the built-in EtherNet/IP port settings.		Perform the Clear All Memory operation or download the settings again.		Do not turn OFF the power supply to the Controller while a download is in progress for the built-in EtherNet/IP port settings.	
	Memory error		If operation is not recovered by the above replace the CPU Unit.		None	
Attached information	<p>Attached information 1: Type of errors (01 hex: Non-volatile memory access error, 02 hex: Inconsistency in settings)</p> <p>Attached information 2: Error Details (00 hex: Non-volatile memory access error When the settings are inconsistent 14 hex: Preferred DNS setting error, 15 hex: Alternate DNS setting error, 16 hex: Illegal domain name, 17Hex: Illegal Hosts setting)</p>					

Precautions/Remarks	The cause of error can be identified with the attached information.
----------------------------	---

*1. This event code occurs for unit version 1.10 or later of the CPU Unit.

Event name	Link Setting Not Supported		Event code	342B0000 hex		
Meaning	Unsupported LINK settings. The Controller is operating with LINK setting set to Auto.					
Source	EtherNet/IP Function Module		Source details	Communica- tions port, com- munications port 1 or 2	Detection tim- ing	At power ON, Controller reset, or synchroniza- tion transfer / re- storage from the Sysmac Stu- dio
Error attributes	Level	Minor fault	Recovery	Automatic re- covery (after downloading the settings)	Log category	System
Effects	User program	Continues.	Operation	Not affected.		
Indicators	EtherNet/IP NET RUN		EtherNet/IP NET ERR		EtherNet/IP LINK/ACT	
	---		Flashes at 1-s intervals.		---	
System-de- fined variables	Variable		Data type		Name	
	None		---		---	
Cause and cor- rection	Assumed cause		Correction		Prevention	
	An item other than Auto is selected for LINK settings on the CPU Unit whose hardware revision supports only Auto setting of LINK settings.		Change the setting to Auto from the Sysmac Studio and download the project.		None	
Attached infor- mation	None					
Precautions/ Remarks	LINK setting must be set to Auto for some hardware revisions of the CPU Units. Refer to <i>LINK Settings Display</i> in the <i>NJ/NX-series CPU Unit Built-in EtherNet/IP Port User's Manual (Cat. No. W506)</i> for details.					

Event name	Controller Insufficient Memory Warning		Event code	50010000 hex ^{*1}		
Meaning	The amount of data for the EtherCAT slave configuration, network-published information, or other data exceeds the value that is specified for the CPU Unit. You may not be able to perform online editing or other operations.					
Source	EtherCAT Master Function Module or EtherNet/IP Function Module		Source details	Master or CIP	Detection timing	At power ON, download, or online editing
Error attributes	Level	Minor fault	Recovery	Automatic recovery	Log category	System
Effects	User program	Continues.	Operation	Not affected.		
Indicators	EtherNet/IP NET RUN		EtherNet/IP NET ERR		EtherNet/IP LINK/ACT	
	---		---		---	
System-defined variables	Variable	Data type		Name		
	None	---		---		
Cause and correction	Assumed cause		Correction		Prevention	
	The amount of data for the EtherCAT slave configuration, network-published information, or other data exceeds the value that is specified for the CPU Unit.		Reduce the number of PDOs that are used by the EtherCAT slaves. Reduce the number of data types that are used for network variables or reduce the length of the text strings that are used for names.		None	
Attached information	None					
Precautions/Remarks	You may not be able to perform online editing or other operations.					

*1. This event code occurs for unit version 1.02 or later of the CPU Unit.

Event name	DNS Server Connection Error		Event code	84030000 hex		
Meaning	Connection with the DNS server failed.					
Source	EtherNet/IP Function Module		Source details	Communica- tions port	Detection tim- ing	At DNS opera- tion
Error attributes	Level	Minor fault	Recovery	Automatic re- covery (after downloading the DNS settings)	Log category	System
Effects	User program	Continues.	Operation	Communications using DNS stop.		
Indicators	EtherNet/IP NET RUN		EtherNet/IP NET ERR		EtherNet/IP LINK/ACT	
	---		Flashes at 1-s intervals.		---	
System-de- fined variables	Variable		Data type		Name	
	_EIP_DNSSrvErr		BOOL		DNS Server Connection Error	
Cause and cor- rection	Assumed cause		Correction		Prevention	
	Setting error		If there is a mistake with the speci- fications of the connected server, correct the server specifications and download them again.		Make sure that the connected serv- er is specified correctly.	
	The server is down.		Check if the server at the remote connection is operating normally and set it to operate normally if it is not.		Check to make sure that the server at the remote connection is operat- ing normally.	
	An error occurred in the communi- cations path.		Check the communications path to the server and take corrective measures if there are any prob- lems.		None	
Attached infor- mation	None					
Precautions/ Remarks	None					

Event name	NTP Server Connection Error		Event code	84040000 hex	
Meaning	Connection with the NTP server failed.				
Source	EtherNet/IP Function Module		Source details	NTP	Detection timing At NTP operation
Error attributes	Level	Minor fault	Recovery	Automatic recovery (after downloading the NTP settings)	Log category System
Effects	User program	Continues.	Operation	Time cannot be acquired from NTP.	
Indicators	EtherNet/IP NET RUN		EtherNet/IP NET ERR		EtherNet/IP LINK/ACT
	---		Flashes at 1-s intervals.		---
System-defined variables	Variable		Data type		Name
	_EIP_NTPSrvErr		BOOL		NTP Server Connection Error
Cause and correction	Assumed cause		Correction		Prevention
	Setting error		If there is a mistake with the specifications of the connected server, correct the server specifications and download them again.		Make sure that the connected server is specified correctly.
	The server is down.		Check if the server at the remote connection is operating normally and set it to operate normally if it is not.		Check to make sure that the server at the remote connection is operating normally.
	An error occurred in the communications path.		Check the communications path to the server and take corrective measures if there are any problems.		None
Attached information	None				
Precautions/Remarks	<p>For CPU Units with unit version 1.37 or later (NX701-□□□□) or unit version 1.70 or later (other than NX701-□□□□), you can change the event level to observation. If you change to the observation level, the <i>EtherNet/IP NET ERR</i> column above will be changed to --- (<i>no change</i>).</p> <p>If you change to the observation level, you can check whether the NTP Server Connection Error is persisting using the <i>_EIP_NTPSrvErr</i> system-defined variable.</p>				

Event name	Tag Data Link Connection Failed		Event code	84070000 hex	
Meaning	Establishing a tag data link connection failed.				
Source	In the CPU Unit, EtherNet/IP Function Module. For the X Bus Unit, X Bus Ethernet/IP Function Module	Source details	CIP ^{*1} /CIP1 ^{*2} / CIP2 ^{*2} /1 to 4: <i>Mounting position of the X Bus Unit and CIP1 /CIP2 are given in combination.*4</i>	Detection timing	When establishing tag data link connection
Error attributes	Level	Minor fault	Recovery	Automatic recovery	Log category System
Effects	User program	Continues.	Operation	Data links will not operate for connections that could not be established. Data links for other connections will operate.	
Indicators	EtherNet/IP NET RUN		EtherNet/IP NET ERR		EtherNet/IP LINK/ACT
	Flashes at 1-s intervals.		Flashes at 1-s intervals.		---
System-defined variable	Variable	Data type	Name		
	_EIP_TDLINKOpnErr ^{*1} ^{*3}	BOOL	Tag Data Link Connection Failed		
	_EIP1_TDLINKOpnErr ^{*2} ^{*3}	BOOL	CIP Communications1 Tag Data Link Connection Failed		
	_EIP2_TDLINKOpnErr ^{*2} ^{*3}	BOOL	CIP Communications2 Tag Data Link Connection Failed		
	EIP_Comm1Status.TDLINKOpnErr ^{*4}	BOOL	CIP Communications1 Tag Data Link Connection Failed		
	EIP_Comm2Status.TDLINKOpnErr ^{*4}	BOOL	CIP Communications2 Tag Data Link Connection Failed		
Cause and correction	Assumed cause	Correction		Prevention	
	The tag data link connection information is not the same for the originator and target.	Correct the tag data link connection information, and then download the device parameters or connection settings from the Network Configurator or Sysmac Studio.		Before you use the tag data links, make sure that the tag data link connection information in the originator and target are suitable.	
	Insufficient connections	Reduce the number of class-3 messages.		Reduce the number of data links and class-3 messages that are used.	
	CIP message communications at the target node are stopped. (for NJ/NX-series CPU Units)	Make the device start normal CIP message communications.		Make the device start normal CIP message communications before you use a tag data link.	
	Setting to use tag data link communications was made to the NX-series EtherNet/IP Unit that is included in the CIP Safety connection settings (for NX-series EtherNet/IP Units).	Do not configure the NX-series EtherNet/IP Unit, which is included in the CIP Safety connection settings, to use tag data link communications (for NX-series EtherNet/IP Units).		Do not configure the NX-series EtherNet/IP Unit, which is included in the CIP Safety connection settings, to use tag data link communications (for NX-series EtherNet/IP Units).	
	The NX-series EtherNet/IP Unit with tag data link communications was added to the CIP Safety connection settings (for NX-series EtherNet/IP Units).	Do not add the NX-series EtherNet/IP Unit, for which tag data link communications are set to use, to the CIP Safety connection settings (for NX-series EtherNet/IP Units).		Do not add the NX-series EtherNet/IP Unit, for which tag data link communications are set to use, to the CIP Safety connection settings (for NX-series EtherNet/IP Units).	
Attached information	Attached information 1: Target node IP address (example: C0A8FA01 hex = address 192.168.250.1) Attached information 2: Connection instance No. 0 to 255 ^{*5} Attached information 3: Connection status (example: 01000117 hex for General Status 01 and Additional Status 0117) ^{*5}				

Precautions/ Remarks	<ul style="list-style-type: none">• You can investigate a detailed cause from the connection status. Refer to the Connection Status Codes and Troubleshooting described in the <i>NJ/NX-series CPU Unit Built-in EtherNet/IP Port User's Manual (Cat. No. W506)</i>.• This event occurs only once even if this error occurred simultaneously in several connections for the same target node.
---------------------------------	--

- *1. This applies to an NJ-series CPU Unit.
- *2. This applies to an NX-series CPU Unit.
- *3. This applies to a unit other than NX-series EtherNet/IP Unit.
- *4. This applies to an NX-series EtherNet/IP Unit.
- *5. Attached information 2 and 3 are not available for a CPU Unit with unit version 1.10 or earlier.

Event name	Tag Data Link Timeout		Event code	84080000 hex	
Meaning	A timeout occurred in a tag data link.				
Source	In the CPU Unit, EtherNet/IP Function Module. For the X Bus Unit, X Bus Ethernet/IP Function Module	Source details	CIP ^{*1} /CIP1 ^{*2} / CIP2 ^{*2} /1 to 4: <i>Mounting position of the X Bus Unit</i> and CIP1 /CIP2 are given in combination. ^{*4}	Detection timing	Continuously after starting tag data link communications
Error attributes	Level	Minor fault	Recovery	Automatic recovery	Log category System
Effects	User program	Continues.	Operation	The relevant data link connection will stop. Reconnection processing is periodically repeated for the tag data link error target.	
Indicators	EtherNet/IP NET RUN		EtherNet/IP NET ERR		EtherNet/IP LINK/ACT
	Flashes at 1-s intervals.		Flashes at 1-s intervals.		---
System-defined variable	Variable	Data type	Name		
	_EIP_TDLinkErr ^{*1 *3}	BOOL	Tag Data Link Communications Error		
	_EIP1_TDLinkErr ^{*2 *3}	BOOL	CIP Communications1 Tag Data Link Communications Error		
	_EIP2_TDLinkErr ^{*2 *3}	BOOL	CIP Communications2 Tag Data Link Communications Error		
	EIP_Comm1Status.TDLinkErr ^{*4}	BOOL	CIP Communications1 Tag Data Link Communications Error		
	EIP_Comm2Status.TDLinkErr ^{*4}	BOOL	CIP Communications2 Tag Data Link Communications Error		

Cause and correction	Assumed cause	Correction	Prevention
	The power supply to the target node is OFF.	Check the status of the target node and start it normally.	Use the tag data link after you confirm that the target node is normal.
	Communications with the target node stop.		
	The Ethernet cable connector for EtherNet/IP is disconnected.	Reconnect the connector and make sure it is connected correctly.	Connect the connector securely.
	The Ethernet cable for EtherNet/IP is broken.	Replace the Ethernet cable.	None
	The link to the built-in EtherNet/IP port is OFF.	Refer to the Link OFF Detected error (84060000 hex) for the assumed causes and other information on link OFF.	Refer to the Link OFF Detected error (84060000 hex) for the assumed causes and other information on link OFF.
	CIP message communications at the target node are stopped. (for NJ/NX-series CPU Units)	Make the device start normal CIP message communications.	Make the device start normal CIP message communications before you use a tag data link.
	When the Packet Filter function is enabled in the Built-in EtherNet/IP Port Settings, packets from the target are not allowed. (for NJ/NX-series CPU Units) ^{*5}	Allow packets from the target in the Packet Filter settings of the Built-in EtherNet/IP Port Settings.	Make sure that packets from the target are allowed in the Packet Filter settings of the Built-in EtherNet/IP Port Settings before you use a tag data link.
	CIP communications are not allowed by the Packet Filter (Simple) or Packet Filter functions on the target node or the devices on the communication path. (for NJ/NX-series CPU Units)	Allow CIP communications in the Packet Filter (Simple) or Packet Filter functions on the target node or the devices on the communication path.	Make sure that CIP communications are allowed in the Packet Filter (Simple) or Packet Filter functions on the target node or the devices on the communication path to use tag data links.
	The packet loss occurred on the path due to the network communications load.	Increase the timeout value or RPI. Or, review the network environment and network devices.	Design the network so that there is not too much load on the network.
Noise	Implement noise countermeasures if there is excessive noise.	Implement noise countermeasures if there is excessive noise.	
Attached information	Attached information 1: Connection instance No. 0 to 255 Attached information 2: Target node IP address (example: C0A8FA01 hex = address 192.168.250.1)		
Precautions/Remarks	<ul style="list-style-type: none"> The following cases are not included in this error. Connections as a target This event occurs only once even if this error occurred simultaneously in several connections for the same target node. 		

*1. This applies to an NJ-series CPU Unit.

*2. This applies to an NX-series CPU Unit.

*3. This applies to a unit other than NX-series EtherNet/IP Unit.

*4. This applies to an NX-series EtherNet/IP Unit.

*5. Assumed cause for the following CPU Units.

- NJ-series, NX102, NX1P2 CPU Unit: Version 1.49 or later
- NX502 CPU Unit: Version 1.60 or later
- NX701 CPU Unit: Version 1.29 or later

Event name	Tag Data Link Connection Timeout		Event code	84090000 hex*1		
Meaning	A timeout occurred while trying to establish a tag data link connection.					
Source	In the CPU Unit, EtherNet/IP Function Module. For the X Bus Unit, X Bus Ethernet/IP Function Module		Source details	CIP *2/CIP1 *3/ CIP2 *3/1 to 4: <i>Mounting position of the X Bus Unit</i> and CIP1 /CIP2 are given in combination.*5	Detection timing	When establishing tag data link connection
Error attributes	Level	Minor fault	Recovery	Automatic recovery	Log category	System
Effects	User program	Continues.	Operation	Data links will not operate for connections that timed out. Reconnection processing is periodically repeated for the connection that timed out.		
Indicators	EtherNet/IP NET RUN		EtherNet/IP NET ERR		EtherNet/IP LINK/ACT	
	Flashes at 1-s intervals.		Flashes at 1-s intervals.		---	
System-defined variable	Variable	Data type	Name			
	_EIP_TDLINKOpnErr *2 *4	BOOL	Tag Data Link Connection Failed			
	_EIP1_TDLINKOpnErr *3 *4	BOOL	CIP Communications1 Tag Data Link Connection Failed			
	_EIP2_TDLINKOpnErr *3 *4	BOOL	CIP Communications2 Tag Data Link Connection Failed			
	EIP_Comm1Status.TDLINKOpnErr *5	BOOL	CIP Communications1 Tag Data Link Connection Failed			
	EIP_Comm2Status.TDLINKOpnErr *5	BOOL	CIP Communications2 Tag Data Link Connection Failed			
Cause and correction	Assumed cause	Correction		Prevention		
	The power supply to the target node is OFF.	Check the status of the target node and start it normally.		Use the tag data link after you confirm that the target node is normal.		
	Communications at the target node are stopped.					
	CIP message communications are stopped at the target node or built-in EtherNet/IP Port. (for NJ/NX-series CPU Units)*6	Make the device start normal CIP message communications.		Make the device start normal CIP message communications before you use a tag data link.		
	The Ethernet cable connector for EtherNet/IP is disconnected.	Reconnect the connector and make sure it is connected correctly.		Connect the connector securely.		
	The Ethernet cable for EtherNet/IP is broken.	Replace the Ethernet cable.		None		
	CIP communications are not allowed by the Packet Filter (Simple) or Packet Filter functions on the target node or the devices on the communication path. (for NJ/NX-series CPU Units)	Allow CIP communications in the Packet Filter (Simple) or Packet Filter functions on the target node or the devices on the communication path.		Make sure that CIP communications are allowed in the Packet Filter (Simple) or Packet Filter functions on the target node or the devices on the communication path to use tag data links.		
	An error occurred in the communications path.	Check the communications path and take corrective measures if there are any problems.		None		
Attached information	Attached information 1: Target node IP address (example: C0A8FA01 hex = address 192.168.250.1)					

Precautions/ Remarks	<ul style="list-style-type: none">• You can change the event level to the observation level. If you change the level to the observation level, the EtherNet/IP NET ERR column above will be changed to “---” (no change) and recovery will not be necessary.• The following cases are not included in this error. Connections as a target Connection timeouts due to a Link OFF detection for an Ethernet switch• This event occurs only once even if this error occurred simultaneously in several connections for the same target node.
---------------------------------	---

*1. This event code occurs for unit version 1.04 or later of the CPU Unit.

*2. This applies to an NJ-series CPU Unit.

*3. This applies to an NX-series CPU Unit.

*4. This applies to a unit other than NX-series EtherNet/IP Unit.

*5. This applies to an NX-series EtherNet/IP Unit.

*6. Assumed cause for the following CPU Units.

- NJ-series, NX102, NX1P2 CPU Unit: Version 1.49 or later
- NX502 CPU Unit: Version 1.60 or later
- NX701 CPU Unit: Version 1.29 or later

Event name	IP Address Duplication Error		Event code	840A0000 hex *1	
Meaning	The same IP address is used more than once.				
Source	EtherNet/IP Function Module		Source details	Communications port 1 or 2, or Internal port 1	Detection timing After link is established
Error attributes	Level	Minor fault	Recovery	Automatic recovery (after downloading the IP address settings), cycle the power supply, or reset Controller.	Log category System
Effects	User program	Continues.	Operation	EtherNet/IP communications are not possible for the relevant communications port. Packets addressed to the local IP address of the relevant communications port are discarded.	
Indicators	EtherNet/IP NET RUN		EtherNet/IP NET ERR		EtherNet/IP LINK/ACT
	OFF		Flashes at 1-s intervals.		---
System-defined variable	Variable		Data type		Name
	_EIP1_IPAdrDupErr		BOOL		Port1 IP Address Duplication Error
	_EIP2_IPAdrDupErr		BOOL		Port2 IP Address Duplication Error
	_EIPIn1_IPAdrDupErr		BOOL		Internal Port1 IP Address Duplication Error
Cause and correction	Assumed cause		Correction		Prevention
	The IP address of the built-in EtherNet/IP port is also used as the IP address of another node.		Perform either of the following corrections. <ul style="list-style-type: none"> • Check the IP addresses of other nodes and correct the IP address settings so that the same address is not used by more than one node. • Remove the other node that has the duplicate IP address from the network and then cycle the power supply to the Controller or reset the Controller. 		Perform allocations so that IP addresses of nodes on the network are used for only one node.
Attached information	Attached information 1: Duplicated IP address (example: C0A8FA01 hex = address 192.168.250.1)				
Precautions/Remarks	A duplicated address error occurs if an ARP is sent with the set IP address and there is an ARP response.				

*1. This event code occurs for unit version 1.10 or later of the CPU Unit.

Event name	BOOTP Server Connection Error		Event code	840B0000 hex *1		
Meaning	Connection with the BOOTP server failed.					
Source	EtherNet/IP Function Module		Source details	Communications port 1 or 2	Detection timing	At BOOTP operation
Error attributes	Level	Minor fault	Recovery	Automatic recovery	Log category	System
Effects	User program	Continues.	Operation	EtherNet/IP communications are not possible for the relevant communications port. Requests to the BOOTP server will continue until there is a response from the BOOTP server. Data refreshing with the PLC Function Module will continue. An IP address was not set for the EtherNet/IP port when it was supposed to be set from the BOOTP server.		
Indicators	EtherNet/IP NET RUN		EtherNet/IP NET ERR		EtherNet/IP LINK/ACT	
	OFF		Flashes at 1-s intervals.		---	
System-defined variables	Variable	Data type		Name		
	_EIP1_BootpErr	BOOL		Port1 BOOTP Server Error		
	_EIP2_BootpErr	BOOL		Port2 BOOTP Server Error		
Cause and correction	Assumed cause		Correction		Prevention	
	Server setting error		Correct the server settings at the remote connection.		Check to make sure that the server settings at the remote connection are correct.	
	The server is down.		Check if the server at the remote connection is operating normally and set it to operate normally if it is not.		Check to make sure that the server at the remote connection is operating normally.	
	An error occurred in the communications path.		Check the communications path to the server and take corrective measures if there are any problems.		None	
Attached information	None					
Precautions/Remarks	None					

*1. This event code occurs for unit version 1.10 or later of the CPU Unit.

Event name	Allowed Communications Bandwidth per Unit Exceeded		Event code	840C0000 hex *1		
Meaning	The total bandwidth for the connections that are set or established exceeded the allowed communications bandwidth of tag data links and CIP Safety communications*2 per Unit for all of the built-in EtherNet/IP ports.					
Source	In the CPU Unit, EtherNet/IP Function Module. For the X Bus Unit, X Bus Ethernet/IP Function Module		Source details	CIP1/CIP2/ 1 to 4: <i>Mounting position of the X Bus Unit</i> and CIP1 /CIP2 are given in combination.*4	Detection timing	When establishing tag data link connection or CIP Safety connection
Error attributes	Level	Minor fault	Recovery	Automatic recovery (after downloading the settings), cycle the power supply, or reset Controller.	Log category	System
Effects	User program	Continues.	Operation	Tag data links and CIP Safety communications*2 will not operate in the bandwidth that exceeds the allowed communications bandwidth per Unit.		
Indicators	EtherNet/IP NET RUN		EtherNet/IP NET ERR		EtherNet/IP LINK/ACT	
	Flashes at 1-s intervals.		Flashes at 1-s intervals.		---	
System-defined variable	Variable		Data type		Name	
	_EIP_TDLinkOpnErr *3		BOOL		Tag Data Link Connection Failed	
	_EIP1_TDLinkOpnErr *3		BOOL		CIP Communications1 Tag Data Link Connection Failed	
	_EIP2_TDLinkOpnErr *3		BOOL		CIP Communications2 Tag Data Link Connection Failed	
	EIP_Comm1Status.TDLinkOpnErr *4		BOOL		CIP Communications1 Tag Data Link Connection Failed	
	EIP_Comm2Status.TDLinkOpnErr *4		BOOL		CIP Communications2 Tag Data Link Connection Failed	
Cause and correction	Assumed cause		Correction		Prevention	
	An attempt was made to establish a connection that would cause the used bandwidth (PPS) total of the packet transfer rates of the tag data links and CIP Safety communications*2 that use all of the built-in EtherNet/IP ports to exceed the allowed communications bandwidth per Unit.		Change the settings at the originator node for the tag data links and CIP Safety communications*2 so that the total PPS for all of the built-in EtherNet/IP ports does not exceed the allowed communications bandwidth per Unit, and then cycle the power supply to the Controller or reset the Controller.		Set the tag data links and CIP Safety communications*2 so that the total PPS for all of the built-in EtherNet/IP ports does not exceed the allowed communications bandwidth per Unit.	
Attached information	None					
Precautions/Remarks	You can confirm the bandwidth (PPS) of the tag data link for EtherNet/IP ports in the Ethernet Information Tab Page on the Network Configurator. Refer to <i>Ethernet Information Tab Page</i> section in <i>Checking Status with the Network Configurator</i> in the for how to confirm the bandwidth (PPS) on the Network Configurator.					

*1. This event code occurs for unit version 1.10 or later of the CPU Unit.

*2. This applies for a CPU Unit that supports CIP Safety communications.

*3. This applies to a Unit other than NX-series EtherNet/IP Unit.

*4. This applies to an NX-series EtherNet/IP Unit.

Event name	Number of Tag Sets for Tag Data Links Exceeded		Event code	840E0000 hex*1		
Meaning	The total number of tag sets for tag data links for all ports of the built-in Ethernet/IP port exceeds the upper limit.					
Source	In the CPU Unit, EtherNet/IP Function Module. For the X Bus Unit, X Bus Ethernet/IP Function Module		Source details	CIP1/CIP2/ 1 to 4: <i>Mounting position of the X Bus Unit</i> and CIP1 /CIP2 are given in combination.*3	Detection timing	At power ON, Controller reset, download from the Sysmac Studio, or download from the Network Configurator
Error attributes	Level	Minor fault	Recovery	Automatic recovery	Log category	System
Effects	User program	Continues.	Operation	Tag data link communications for the relevant port were stopped.		
Indicators	EtherNet/IP NET RUN		EtherNet/IP NET ERR		EtherNet/IP LINK/ACT	
	Flashes at 1-s intervals.		Flashes at 1-s intervals.		---	
System-defined variable	Variable	Data type		Name		
	_EIP_TDLINKCfgErr	BOOL		Tag Data Link Setting Error		
	_EIP1_TDLINKCfgErr	BOOL		CIP Communications1 Tag Data Link Setting Error		
	_EIP2_TDLINKCfgErr	BOOL		CIP Communications2 Tag Data Link Setting Error		
	EIP_Comm1Status.TDLINKCfgErr*3	BOOL		CIP Communications1 Tag Data Link Setting Error		
	EIP_Comm2Status.TDLINKCfgErr*3	BOOL		CIP Communications2 Tag Data Link Setting Error		
Cause and correction	Assumed cause	Correction		Prevention		
	The total number for all ports of tag sets for tag data links that are set for each built-in Ethernet/IP port exceeds the total number of which the product can be allowed.	Change the number of tag sets so that the total number for all ports of tag sets for tag data links that are set for each built-in Ethernet/IP port does not exceed the total number of which the product can be allowed.		When the number of tag sets for tag data links that are set for each built-in Ethernet/IP port is changed, check that the total number of tag sets for all ports does not exceed the total number of which the product can be allowed in advance.		
Attached information	Attached information 1: The number of tag sets that are set for the port. Attached information 2: Total number of tag sets that are set for the product. Attached information 3: Total number of tag sets that the product can be allowed.					
Precautions/Remarks	None					

*1. This event code occurs for an NX102 CPU Unit.

*2. This applies to a unit other than NX-series EtherNet/IP Unit.

*3. This applies to an NX-series EtherNet/IP Unit.

Event name	Access Detected Outside Range of Variable		Event code	54E0000Hex		
Meaning	Accessing a value that is out of range was detected for a tag variable that is used in a tag data link.					
Source	In the CPU Unit, EtherNet/IP Function Module. For the X Bus Unit, X Bus Ethernet/IP Function Module		Source details	Communications port/ <i>CIP1 /CIP2</i> ^{*1}	Detection timing	When variable is written
Error attributes	Level	Observation	Recovery	---	Log category	System
Effects	User program	Continues.	Operation	Not affected.		
Indicators	EtherNet/IP NET RUN		EtherNet/IP NET ERR		EtherNet/IP LINK/ACT	
	---		---		---	
System-defined variables	Variable		Data type		Name	
	None		---		---	
Cause and correction	Assumed cause		Correction		Prevention	
	An out-of-range value was written by an EtherNet/IP tag data link for a variable with a specified range. A value that does not specify an enumerator was written by an EtherNet/IP tag data link for an enumeration variable.		Correct the value that is written to the variable with a specified range so that the value is in the range. Correct the value that is written to the enumeration variable so that the value specifies an enumerator.		Write values that are in range for variables with specified ranges. Write values that specify enumerators to enumeration variables.	
Attached information	None					
Precautions/Remarks	<ul style="list-style-type: none"> • Write operations for out-of-range values or values that do not specify enumerators do not end normally. • Write operations for in-range values or values that specify enumerators end normally. 					

*1. This applies to an NX-series EtherNet/IP Unit.

Event name	Packet Discarded Due to Full Receive Buffer		Event code	84050000 hex		
Meaning	A packet was discarded.					
Source	EtherNet/IP Function Module		Source details	Communica- tions port, ^{*1} communications port 1, ^{*2} or com- munications port 2 ^{*2}	Detection tim- ing	After link is es- tablished
Error attributes	Level	Observation	Recovery	---	Log category	System
Effects	User program	Continues.	Operation	Not affected.		
Indicators	EtherNet/IP NET RUN		EtherNet/IP NET ERR		EtherNet/IP LINK/ACT	
	---		---		---	
System-de- fined variables	Variable	Data type		Name		
	None	---		---		
Cause and cor- rection	Assumed cause		Correction		Prevention	
	A network convergence occurred.		The load on the network is too high. Check whether there are nodes that send unnecessary broadcast frames on the network and remove them. After that, check that the received number of frames has reduced in the network statistical information.		Make sure that unnecessary broadcast frames are not sent on the network. Do not connect the Ethernet cable in a loop.	
Attached infor- mation	None					
Precautions/ Remarks	None					

*1. This applies to an NJ-series CPU Unit.

*2. This applies to an NX-series CPU Unit.

Event name	Link OFF Detected		Event code	84060000 hex		
Meaning	An Ethernet link OFF was detected.					
Source	EtherNet/IP Function Module	Source details	Communica- tions port *1/ Communica- tions port 1 *2/ Communica- tions port 2 *2/ Internal port 1	Detection tim- ing	Continuously	
Error attributes	Level	Observation	Recovery	---	Log category	System
Effects	User program	Continues.	Operation	EtherNet/IP communications will not operate.		
Indicators	EtherNet/IP NET RUN		EtherNet/IP NET ERR		EtherNet/IP LINK/ACT	
	---		---		OFF	
System-de- fined variables	Variable	Data type		Name		
	None	---		---		
Cause and cor- rection	Assumed cause		Correction		Prevention	
	An Ethernet cable is broken, dis- connected, or loose.		Firmly connect the Ethernet cable. Replace the cable if it is broken.		Firmly connect the Ethernet cable. Also, make sure that the cable to be used is not disconnected.	
	The Ethernet switch's power sup- ply is turned OFF.		Turn ON the power supply to the Ethernet switch. Replace the Ethernet switch if it fails.		Do not turn OFF the Ethernet switch.	
	Communications speed mismatch- ed.		Modify the setting so that the com- munication speed is the same as that of the remote node.		Set the same communication speed as that on the remote node.	
	Noise		Implement noise countermeasures if there is excessive noise.		Implement noise countermeasures.	
	One of the following operations was performed. <ul style="list-style-type: none"> The Identity object was reset. Settings for EtherNet/IP were downloaded from the Network Configurator or Sysmac Studio, or the Clear All Memory opera- tion was performed. EtherNet/IP was restarted. 		None. This error occurs when the operations on the left are per- formed.		None. This error occurs when the operations on the left are per- formed.	
	If an Ethernet link off is detected on port 2, Use Port 2 check box is not selected.		When using port2, select the Use Port 2 Check Box and configure the settings.		Make sure that the Use Port 2 set- ting is correct.	
Attached infor- mation	None					
Precautions/ Remarks	The level can be changed to minor fault. When it is changed to minor fault, the recovery method used is "auto- matic recovery".					

*1. This applies to an NJ-series CPU Unit.

*2. This applies to an NX-series CPU Unit.

Event name	DHCP Server Connection Error		Event code	840F0000 hex		
Meaning	Connection to the DHCP server failed.					
Source	EtherNet/IP Function Module		Source details	Communica- tions port 1 or 2	Detection tim- ing	When DHCP is in operation
Error attributes	Level	Minor fault	Recovery	Automatic re- covery	Log category	System
Effects	User program	Continues.	Operation	EtherNet/IP communications are not possible for the relevant communications port. Requests to the DHCP server will continue until there is a response from the DHCP server. Data refreshing with the PLC Function Module will continue. An IP address was not set for the EtherNet/IP port for which the DHCP server attempted to set an IP address.		
Indicators	EtherNet/IP NET RUN		EtherNet/IP NET ERR		EtherNet/IP LINK/ACT	
	OFF		Flashes at 1-s intervals.		---	
System-de- fined variables	Variable		Data type		Name	
	_EIP1_DhcpErr		BOOL		Port1 DHCP Server Error	
	_EIP2_DhcpErr		BOOL		Port2 DHCP Server Error	
Cause and cor- rection	Assumed cause		Correction		Prevention	
	The server is misconfigured.		Correct the server settings at the remote connection.		Check to make sure that the server settings at the remote connection are correct.	
	The server went down.		Check if the server at the remote connection is operating normally and set it to operate normally if it is not.		Check to make sure that the server at the remote connection is operating normally.	
	An error occurred in the communi- cations path.		Check the communications path to the server and take corrective measures if there are any prob- lems.		None	
Attached infor- mation	None					
Precautions/ Remarks	None					

Event name	TLS Log Saving Failed		Event code	940F0000 hex*1		
Meaning	Failed to save the TLS log to the SD Memory Card.					
Source	EtherNet/IP Function Module		Source details	Communica- tions port	Detection tim- ing	When TLS log- ging is enabled but the log could not be saved.
Error attributes	Level	Observation	Recovery	---	Log category	System
Effects	User program	Continues.	Operation	Not affected.		
Indicators	EtherNet/IP NET RUN		EtherNet/IP NET ERR		EtherNet/IP LINK/ACT	
	---		---		---	
System-de- fined variables	Variable	Data type		Name		
	None	---		---		
Cause and cor- rection	Assumed cause		Correction		Prevention	
	An SD Memory Card is not insert- ed.		Insert an SD Memory Card.		Insert an SD Memory Card.	
	The SD Memory Card type is not correct.		Replace the SD Memory Card with an SD or SDHC card.		Use an SD or SDHC card.	
	The SD Memory Card format is in- valid.		Format the SD Memory Card with the Sysmac Studio.		Use a formatted SD Memory Card. Do not turn OFF the power supply or remove the SD Memory Card while the SD BUSY indicator is lit.	
	The SD Memory Card is write pro- tected.		Remove write protection from the SD Memory Card.		Make sure that the SD Memory Card is not write protected.	
	The SD Memory Card does not have sufficient available space.		Replace the SD Memory Card for one with sufficient available space.		Use an SD Memory Card that has sufficient available space.	
	The SD Memory Card is damaged.		Replace the SD Memory Card.		Do not remove the SD Memory Card or turn OFF the power supply while the SD BUSY indicator is lit. Or, replace the SD Memory Card periodically according to the write life of the SD Memory Card. Do not remove the SD Memory Card while the SD PWR indicator is lit.	
Attached infor- mation	None					
Precautions/ Remarks	None					

*1. This event code occurs for the following CPU Units.

- NX102-□□00, NX1P2-□□□□□□: Version 1.46 or later
- NX102-□□20: Version 1.37 or later
- NX502-1□□□: Version 1.60 or later

Event name	Tag Data Link Download Started		Event code	94010000 hex	
Meaning	Changing the tag data link settings started.				
Source	In the CPU Unit, EtherNet/IP Function Module. For the X Bus Unit, X Bus Ethernet/IP Function Module	Source details	CIP ^{*1} /CIP1 ^{*2} / CIP2 ^{*2} /1 to 4: <i>Mounting position of the X Bus Unit and CIP1 /CIP2 are given in combination.*3</i>	Detection timing	At user operation
Error attributes	Level	Information	Recovery	---	Log category Access
Effects	User program	Continues.	Operation	Not affected.	
Indicators	EtherNet/IP NET RUN		EtherNet/IP NET ERR		EtherNet/IP LINK/ACT
	Flashes at 1-s intervals.		---		---
System-defined variables	Variable	Data type		Name	
	None	---		---	
Cause and correction	Assumed cause		Correction		Prevention
	Changing the tag data link settings started.		---		---
Attached information	Attached information 1: Controller status (01 hex: PROGRAM mode, 02 hex: RUN mode)				
Precautions/Remarks	None				

*1. This applies to an NJ-series CPU Unit.

*2. This applies to an NX-series CPU Unit.

*3. This applies to an NX-series EtherNet/IP Unit.

Event name	Tag Data Link Download Finished		Event code	94020000 hex	
Meaning	Changing the tag data link settings finished.				
Source	In the CPU Unit, EtherNet/IP Function Module. For the X Bus Unit, X Bus Ethernet/IP Function Module	Source details	CIP *1/CIP1 *2/ CIP2 *2/1 to 4: <i>Mounting position of the X Bus Unit and CIP1 /CIP2 are given in combination.*3</i>	Detection timing	At user operation
Error attributes	Level	Information	Recovery	---	Log category Access
Effects	User program	Continues.	Operation	Not affected.	
Indicators	EtherNet/IP NET RUN	EtherNet/IP NET ERR		EtherNet/IP LINK/ACT	
	Flashes at 1-s intervals.	---		---	
System-defined variables	Variable	Data type		Name	
	None	---		---	
Cause and correction	Assumed cause	Correction		Prevention	
	Changing the tag data link settings finished.	---		---	
Attached information	Attached information 1: Controller status (01 hex: PROGRAM mode, 02 hex: RUN mode)				
Precautions/Remarks	None				

*1. This applies to an NJ-series CPU Unit.

*2. This applies to an NX-series CPU Unit.

*3. This applies to an NX-series EtherNet/IP Unit.

Event name	Tag Data Link Stopped		Event code	94030000 hex		
Meaning	Tag data links were stopped by the Network Configurator, Sysmac Studio, special instructions or manipulation of a system-defined variable. Or, the data link table was downloaded from Network Configurator or Sysmac Studio.					
Source	In the CPU Unit, EtherNet/IP Function Module. For the X Bus Unit, X Bus Ethernet/IP Function Module		Source details	CIP ^{*1} /CIP1 ^{*2} / CIP2 ^{*2} /1 to 4: <i>Mounting position of the X Bus Unit</i> and CIP1 /CIP2 are given in combination. ^{*4}	Detection timing	At user operation
Error attributes	Level	Information	Recovery	---	Log category	Access
Effects	User program	Continues.	Operation	Not affected.		
Indicators	EtherNet/IP NET RUN		EtherNet/IP NET ERR		EtherNet/IP LINK/ACT	
	Flashes at 1-s intervals.		---		---	
System-defined variables	Variable		Data type	Name		
	_EIP_TDLINKStopCmd ^{*1} ^{*3}		BOOL	Tag Data Link Communications Stop Switch		
	_EIP1_TDLINKStopCmd ^{*2} ^{*3}		BOOL	CIP Communications1 Tag Data Link Communications Stop Switch		
	_EIP2_TDLINKStopCmd ^{*2} ^{*3}		BOOL	CIP Communications2 Tag Data Link Communications Stop Switch		
Cause and correction	Assumed cause		Correction		Prevention	
	Tag data links were stopped by the Network Configurator, Sysmac Studio, special instructions or manipulation of a system-defined variable.		---		---	
Attached information	Attached information 1: Controller status (01 hex: PROGRAM mode, 02 hex: RUN mode) Attached information 2: Operation method (01 hex: Operation by Network Configurator or Sysmac Studio, 02 hex: Manipulation by a system defined variable, 03 hex: Manipulation by special instructions) Attached information 3: <ul style="list-style-type: none"> • When attached information 2 is 03 hex IP address of the target node • When attached information 2 is a value other than 03 hex 0 					
Precautions/Remarks	None					

*1. This applies to an NJ-series CPU Unit.

*2. This applies to an NX-series CPU Unit.

*3. This applies to a unit other than NX-series EtherNet/IP Unit.

*4. This applies to an NX-series EtherNet/IP Unit.

Event name	Tag Data Link Started		Event code	94040000 hex	
Meaning	Tag data links were started by the Network Configurator, Sysmac Studio, special instructions or manipulation of a system-defined variable. Or, the data link table was downloaded from Network Configurator or Sysmac Studio.				
Source	In the CPU Unit, EtherNet/IP Function Module. For the X Bus Unit, X Bus Ethernet/IP Function Module	Source details	CIP ^{*1} /CIP1 ^{*2} / CIP2 ^{*2} /1 to 4: <i>Mounting position of the X Bus Unit</i> and CIP1 /CIP2 are given in combination.* ⁴	Detection timing	At user operation
Error attributes	Level	Information	Recovery	---	Log category Access
Effects	User program	Continues.	Operation	Not affected.	
Indicators	EtherNet/IP NET RUN		EtherNet/IP NET ERR		EtherNet/IP LINK/ACT
	Flashes at 1-s intervals.		---		---
System-defined variables	Variable	Data type	Name		
	_EIP_TDLINKStartCmd ^{*1} ^{*3}	BOOL	Tag Data Link Communications Start Switch		
	_EIP1_TDLINKStartCmd ^{*2} ^{*3}	BOOL	CIP Communications1 Tag Data Link Communications Start Switch		
	_EIP2_TDLINKStartCmd ^{*2} ^{*3}	BOOL	CIP Communications2 Tag Data Link Communications Start Switch		
Cause and correction	Assumed cause	Correction		Prevention	
	Tag data links were started by the Network Configurator, Sysmac Studio, special instructions or manipulation of a system-defined variable.	---		---	
Attached information	Attached information 1: Controller status (01 hex: PROGRAM mode, 02 hex: RUN mode) Attached information 2: Operation method (01 hex: Operation by Network Configurator or Sysmac Studio, 02 hex: Manipulation by a system defined variable, 03 hex: Manipulation by special instructions) Attached information 3: <ul style="list-style-type: none"> When attached information 2 is 03 hex IP address of the target node When attached information 2 is a value other than 03 hex 0 				
Precautions/Remarks	None				

*1. This applies to an NJ-series CPU Unit.

*2. This applies to an NX-series CPU Unit.

*3. This applies to a unit other than NX-series EtherNet/IP Unit.

*4. This applies to an NX-series EtherNet/IP Unit.

Event name	Link Detected		Event code	94050000 hex		
Meaning	Establishment of an Ethernet link was detected.					
Source	EtherNet/IP Function Module		Source details	Communica- tions port *1/ Communica- tions port 1 *2/ Communica- tions port 2 *2/ Internal port 1	Detection tim- ing	When links are established
Error attributes	Level	Information	Recovery	---	Log category	System
Effects	User program	Continues.	Operation	Not affected.		
Indicators	EtherNet/IP NET RUN		EtherNet/IP NET ERR		EtherNet/IP LINK/ACT	
	---		---		Lights.	
System-de- fined variables	Variable	Data type		Name		
	None	---		---		
Cause and cor- rection	Assumed cause		Correction		Prevention	
	Establishment of an Ethernet link was detected.		---		---	
Attached infor- mation	None					
Precautions/ Remarks	None					

*1. This applies to an NJ-series CPU Unit.

*2. This applies to an NX-series CPU Unit.

Event name	Restarting Ethernet Port		Event code	94060000 hex		
Meaning	The built-in EtherNet/IP port was restarted.					
Source	EtherNet/IP Function Module		Source details	Communica- tions port *1/ Communica- tions port 1 *2/ Communica- tions port 2 *2/ Internal port 1	Detection tim- ing	At user opera- tion
Error attributes	Level	Information	Recovery	---	Log category	Access
Effects	User program	Continues.	Operation	Not affected.		
Indicators	EtherNet/IP NET RUN		EtherNet/IP NET ERR		EtherNet/IP LINK/ACT	
	---		---		---	
System-de- fined variables	Variable	Data type		Name		
	None	---		---		
Cause and cor- rection	Assumed cause		Correction		Prevention	
	The built-in EtherNet/IP port was restarted.		---		---	
Attached infor- mation	None					
Precautions/ Remarks	None					

*1. This applies to an NJ-series CPU Unit.

*2. This applies to an NX-series CPU Unit.

Event name	Tag Data Link All Run		Event code	94070000 hex		
Meaning	Tag data link connections to all nodes have been normally established.					
Source	In the CPU Unit, EtherNet/IP Function Module. For the X Bus Unit, X Bus Ethernet/IP Function Module	Source details	CIP ^{*1} /CIP1 ^{*2} / CIP2 ^{*2} /1 to 4: <i>Mounting position of the X Bus Unit and CIP1 /CIP2 are given in combination.*4</i>	Detection timing	When establishing tag data link connection	
Error attributes	Level	Information	Recovery	---	Log category	System
Effects	User program	Continues.	Operation	Not affected.		
Indicators	EtherNet/IP NET RUN		EtherNet/IP NET ERR		EtherNet/IP LINK/ACT	
	Lights.		---		---	
System-defined variable	Variable	Data type	Name			
	_EIP_TDLINKAllRunSta ^{*1 *3}	BOOL	All Tag Data Link Communications Status			
	_EIP1_TDLINKAllRunSta ^{*2 *3}	BOOL	CIP Communications1 All Tag Data Link Communications Status			
	_EIP2_TDLINKAllRunSta ^{*2 *3}	BOOL	CIP Communications2 All Tag Data Link Communications Status			
	EIP_Comm1Status.TDLINKAllRunSta ^{*4}	BOOL	CIP Communications1 All Tag Data Link Communications Status			
	EIP_Comm2Status.TDLINKAllRunSta ^{*4}	BOOL	CIP Communications2 All Tag Data Link Communications Status			
Cause and correction	Assumed cause	Correction		Prevention		
	Tag data link connections to all target nodes have been established.	---		---		
Attached information	None					
Precautions/Remarks	None					

*1. This applies to an NJ-series CPU Unit.

*2. This applies to an NX-series CPU Unit.

*3. This applies to a unit other than NX-series EtherNet/IP Unit.

*4. This applies to an NX-series EtherNet/IP Unit.

Event name	IP Address Fixed		Event code	94080000 hex	
Meaning	The correct IP address has been determined and Ethernet communications can start.				
Source	EtherNet/IP Function Module	Source details	Communications port *1/ Communications port 1 *2/ Communications port 2 *2/ Internal port 1	Detection timing	At power ON or Controller reset
Error attributes	Level	Information	Recovery	---	Log category System
Effects	User program	Continues.	Operation	Not affected.	
Indicators	EtherNet/IP NET RUN		EtherNet/IP NET ERR		EtherNet/IP LINK/ACT
	Lights.		---		---
System-defined variables	Variable	Data type		Name	
	None	---		---	
Cause and correction	Assumed cause		Correction		Prevention
	The correct IP address has been determined and Ethernet communications can start.		---		---
Attached information	Attached Information 1: IP address (example: C0A8FA01 hex = address 192.168.250.1)				
Precautions/Remarks	None				

*1. This applies to an NJ-series CPU Unit.

*2. This applies to an NX-series CPU Unit.

Event name	BOOTP Client Started		Event code	94090000 hex	
Meaning	The BOOTP client started requesting an IP address.				
Source	EtherNet/IP Function Module	Source details	Communications port,*1 communications port 1,*2 or communications port 2*2	Detection timing	At power ON or Controller reset
Error attributes	Level	Information	Recovery	---	Log category System
Effects	User program	Continues.	Operation	Not affected.	
Indicators	EtherNet/IP NET RUN		EtherNet/IP NET ERR		EtherNet/IP LINK/ACT
	---		---		---
System-defined variables	Variable	Data type		Name	
	None	---		---	
Cause and correction	Assumed cause		Correction		Prevention
	The BOOTP client started requesting an IP address.		---		---
Attached information	None				
Precautions/Remarks	None				

*1. This applies to an NJ-series CPU Unit.

*2. This applies to an NX-series CPU Unit.

Event name	FTP Server Started			Event code	940A0000Hex
Meaning	The FTP agent started normally.				
Source	EtherNet/IP Function Module		Source details	FTP	Detection timing At power ON or Controller reset
Error attributes	Level	Information	Recovery	---	Log category System
Effects	User program	Continues.	Operation	Not affected.	
Indicators	EtherNet/IP NET RUN		EtherNet/IP NET ERR		EtherNet/IP LINK/ACT
	---		---		---
System-defined variables	Variable	Data type		Name	
	None		---		---
Cause and correction	Assumed cause		Correction		Prevention
	The FTP agent started normally.		---		---
Attached information	None				
Precautions/Remarks	None				

Event name	NTP Client Started			Event code	940B0000Hex
Meaning	The NTP client started normally and a request for the NTP server to obtain the time started.				
Source	EtherNet/IP Function Module		Source details	NTP	Detection timing At power ON or Controller reset
Error attributes	Level	Information	Recovery	---	Log category System
Effects	User program	Continues.	Operation	Not affected.	
Indicators	EtherNet/IP NET RUN		EtherNet/IP NET ERR		EtherNet/IP LINK/ACT
	---		---		---
System-defined variables	Variable	Data type		Name	
	None		---		---
Cause and correction	Assumed cause		Correction		Prevention
	The NTP client started normally and a request for the NTP server to obtain the time started.		---		---
Attached information	None				
Precautions/Remarks	None				

Event name	SNMP Started			Event code	940C0000Hex	
Meaning	The SNMP agent started normally.					
Source	EtherNet/IP Function Module	Source details	SNMP	Detection timing	At power ON or Controller reset	
Error attributes	Level	Information	Recovery	---	Log category	System
Effects	User program	Continues.	Operation	Not affected.		
Indicators	EtherNet/IP NET RUN		EtherNet/IP NET ERR		EtherNet/IP LINK/ACT	
	---		---		---	
System-defined variables	Variable	Data type		Name		
	None	---		---		
Cause and correction	Assumed cause		Correction		Prevention	
	The SNMP agent started normally.		---		---	
Attached information	None					
Precautions/Remarks	None					

Event name	TLS Log Started/Stopped			Event code	940E0000 hex*1	
Meaning	TLS logging has started or stopped.					
Source	EtherNet/IP Function Module	Source details	Communications port	Detection timing	At power ON, Controller reset, or when settings are changed from Secure Socket Settings dialog box	
Error attributes	Level	Information	Recovery	---	Log category	System
Effects	User program	Continues.	Operation	Not affected.		
Indicators	EtherNet/IP NET RUN		EtherNet/IP NET ERR		EtherNet/IP LINK/ACT	
	---		---		---	
System-defined variables	Variable	Data type		Name		
	None	---		---		
Cause and correction	Assumed cause		Correction		Prevention	
	TLS logging has started or stopped.		---		---	
Attached information	Attached information 1: 00 hex for TLS logging stopped, and 01 hex for TLS logging started					
Precautions/Remarks	None					

*1. This event code occurs for the following CPU Units.

- NX102-□□□00, NX1P2-□□□□□□: Version 1.46 or later
- NX102-□□□20: Version 1.37 or later
- NX502-1□□□: Version 1.60 or later

Event name	Access to Secure Socket Setting		Event code	94100000 hex*1		
Meaning	Settings have been changed or read from the Secure Socket Settings dialog box*2.					
Source	EtherNet/IP Function Module	Source details	Communica- tions port	Detection tim- ing	when settings are changed from Secure Socket Settings dialog box	
Error attributes	Level	Information	Recovery	---	Log category	Access
Effects	User program	Continues.	Operation	Not affected.		
Indicators	EtherNet/IP NET RUN		EtherNet/IP NET ERR		EtherNet/IP LINK/ACT	
	---		---		---	
System-de- fined variables	Variable name	Data type		Name		
	None	---		---		
Cause and cor- rection	Assumed cause		Correction		Prevention	
	Settings have been changed or read from the Secure Socket Settings dialog box*2.		---		---	
Attached infor- mation	Attached information 1: 00 hex: Secure socket setting was read, 01 hex: Secure socket setting was written, 02 hex: Secure socket setting was deleted Attached information 2: 00 hex: An access to session setting was made, 01 hex: An access to secure socket communications log setting was made Attached information 3: <ul style="list-style-type: none"> When attached information 2 is 00 hex 0 to 29: ID of accessed session (Controllers other than NX102 and NX1P2), 0 to 59: ID of accessed session (NX102 and NX1P2) When attached information 1 is 01 hex and attached information 2 is 01 hex 00 hex: Secure socket communications log setting is disabled, 01 hex: Secure socket communications log setting is enabled 					
Precautions/ Remarks	None					

*1. This event code occurs for the following CPU Units.

- NX102-□□00, NX1P2-□□□□□□: Version 1.46 or later and Ver. 1.48 or earlier
- NX102-□□20: Version 1.37 or later
- NX502-1□□□: Version 1.60 or later

*2. The setting method of the secure socket service depends on the unit version and project unit version of the CPU Unit and version of the Sysmac Studio. Depending on the version, you may use the Secure Socket Settings command instead of the **Secure Socket Settings** dialog box. Refer to *Procedure to Use Secure Socket Setting Function of the Sysmac Studio* in the *NJ/NX-series CPU Unit Built-in EtherNet/IP Port User's Manual (Cat. No. W506)* for details.

Event name	Access to Secure Socket Setting		Event code	94110000 hex ^{*1}		
Meaning	Secure socket setting was changed or read.					
Source	EtherNet/IP Function Module		Source details	Communica- tions port	Detection tim- ing	When secure socket setting was changed or read
Error attributes	Level	Information	Recovery	---	Log category	Access
Effects	User program	Continues.	Operation	Not affected.		
Indicators	EtherNet/IP NET RUN		EtherNet/IP NET ERR		EtherNet/IP LINK/ACT	
	---		---		---	
System-de- fined variables	Variable name		Data type		Name	
	None		---		---	
Cause and cor- rection	Assumed cause		Correction		Prevention	
	Secure socket setting was changed or read.		---		---	
Attached infor- mation	Attached information 1: Connection method <ul style="list-style-type: none"> • 1: Direct connection via USB • 2: Direct connection via Ethernet • 3: Remote Connection via USB or Ethernet connection via a hub Attached information 2: When attached information 1 is 2 or 3, the connection source IP address is given. When connection is made through proxy, proxy IP address is given.					
Precautions/ Remarks	None					
User name in the access log	When the user authentication function is enabled: User name When the user authentication function is disabled: NULL					

- *1. This event code occurs for the following CPU Units.
- NX102-□□00, NX1P2-□□□□□□, NX102-□□20: Version 1.49 or later
 - NX502-1□□□□: Version 1.60 or later

Event name	Change or Reading of Secure Socket Setting		Event code	94120000 hex*1		
Meaning	Secure socket setting was changed or read.					
Source	EtherNet/IP Function Module		Source details	Communica- tions port	Detection tim- ing	When secure socket setting was changed or read
Error attributes	Level	Information	Recovery	---	Log category	System
Effects	User program	Continues.	Operation	Not affected.		
Indicators	EtherNet/IP NET RUN		EtherNet/IP NET ERR		EtherNet/IP LINK/ACT	
	---		---		---	
System-de- fined variables	Variable name		Data type		Name	
	None		---		---	
Cause and cor- rection	Assumed cause		Correction		Prevention	
	Secure socket setting was changed or read.		---		---	
Attached infor- mation	Attached information 1: 00 hex: Secure socket setting was read, 01 hex: Secure socket setting was written, 02 hex: Secure socket setting was deleted Attached information 2: 00 hex: An access to session setting was made, 01 hex: An access to secure socket communications log setting was made Attached information 3: <ul style="list-style-type: none"> • When attached information 2 is 00 hex 0 to 59: ID of accessed session, 255: Secure socket setting was initialized • When attached information 1 is 01 hex and then attached information 2 is 01 hex 00 hex: Secure socket communications log setting is disabled, 01 hex: Secure socket communications log setting is enabled 					
Precautions/ Remarks	None					

*1. This event code occurs for the following CPU Units.

- NX102-□□00, NX1P2-□□□□□□, NX102-□□20: Version 1.49 or later
- NX502-1□□□□: Version 1.60 or later

Event name	IP Address Changed		Event code	94130000 hex ^{*1}		
Meaning	The IP address was changed.					
Source	EtherNet/IP Function Module		Source details	Communica- tions port 1 or 2	Detection tim- ing	If the last IP ad- dress is found to be changed when an IP ad- dress is defined
Error attributes	Level	Information	Recovery	---	Log category	System
Effects	User program	Continues.	Operation	Not affected.		
Indicators	EtherNet/IP NET RUN		EtherNet/IP NET ERR		EtherNet/IP LINK/ACT	
	---		---		---	
System-de- fined variables	Variable name	Data type		Name		
	None	---		---		
Cause and cor- rection	Assumed cause		Correction		Prevention	
	The IP address was changed.		---		---	
Attached infor- mation	Attached information 1: IP address after change, e.g. 192.168.250.1					
Precautions/ Remarks	None					

- *1. This event code occurs for the following CPU Units.
- NJ-series, NX102, NX1P2 CPU Unit: Version 1.49 or later
 - NX502 CPU Unit: Version 1.60 or later
 - NX701 CPU Unit: Version 1.29 or later

Event name	SNMP Settings Changed		Event code	94140000 hex*1		
Meaning	The SNMP settings were changed.					
Source	EtherNet/IP Function Module	Source details	SNMP	Detection timing	When SNMP settings were changed	
Error attributes	Level	Information	Recovery	---	Log category	System
Effects	User program	Continues.	Operation	Not affected.		
Indicators	EtherNet/IP NET RUN		EtherNet/IP NET ERR		EtherNet/IP LINK/ACT	
	---		---		---	
System-defined variables	Variable name		Data type		Name	
	None		---		---	
Cause and correction	Assumed cause		Correction		Prevention	
	SNMP Settings were changed.		---		---	
Attached information	<p>Attached information 1: Changes in SNMP Service</p> <ul style="list-style-type: none"> • 1: SNMP Service enabled • 2: SNMP Service disabled • 3: SNMP Service Settings changed • 4: No change (Not 1, 2, or 3) <p>Attached information 2: Changes in Recognition 1</p> <ul style="list-style-type: none"> • 1: Recognition 1 enabled • 2: Recognition 1 disabled • 3: Recognition 1 setting changed • 4: No change (Not 1, 2, or 3) <p>Attached information 3: Changes in Recognition 2</p> <ul style="list-style-type: none"> • 1: Recognition 2 enabled • 2: Recognition 2 disabled • 3: Recognition 2 setting changed • 4: No change (Not 1, 2, or 3) 					
Precautions/Remarks	None					

*1. This event code occurs for the following CPU Units.

- NJ-series, NX102, NX1P2 CPU Unit: Version 1.49 or later
- NX502 CPU Unit: Version 1.60 or later
- NX701 CPU Unit: Version 1.29 or later

Event name	Subnet Mask Changed		Event code	94150000 hex ^{*1}		
Meaning	The subnet mask was changed.					
Source	EtherNet/IP Function Module		Source details	Communica- tions port 1 or 2	Detection tim- ing	If the last subnet mask is found to be changed when an IP ad- dress is defined
Error attributes	Level	Information	Recovery	---	Log category	System
Effects	User program	Continues.	Operation	Not affected.		
Indicators	EtherNet/IP NET RUN		EtherNet/IP NET ERR		EtherNet/IP LINK/ACT	
	---		---		---	
System-de- fined variable	Variable name	Data type		Name		
	None	---		---		
Cause and cor- rection	Assumed cause		Correction		Prevention	
	The subnet mask was changed.		---		---	
Attached infor- mation	Attached information 1: Subnet mask after change, e.g. 255.255.255.0					
Precautions/ Remarks	None					

*1. This event code occurs for the following CPU Units.

- NJ-series, NX102, NX1P2 CPU Unit: Version 1.49 or later
- NX502 CPU Unit: Version 1.60 or later
- NX701 CPU Unit: Version 1.29 or later

Event name	Restarting Ethernet Port		Event code	96450000 hex		
Meaning	The EtherNet/IP port was restarted.					
Source	In the CPU Unit, EtherNet/IP Function Module. For the X Bus Unit, X Bus Ethernet/IP Function Module		Source details	CIP1/CIP2/ 1 to 4: <i>Mounting position of the X Bus Unit and CIP1 /CIP2 are given in combi- nation.</i> ^{*1}	Detection tim- ing	At user opera- tion
Error attributes	Level	Information	Recovery	---	Log category	Access
Effects	User program	Continues.	Operation	Not affected.		
Indicators	EtherNet/IP NET RUN		EtherNet/IP NET ERR		EtherNet/IP LINK/ACT	
	---		---		---	
System-de- fined variables	Variable	Data type		Name		
	None	---		---		
Cause and cor- rection	Assumed cause		Correction		Prevention	
	The EtherNet/IP port was restart- ed.		---		---	
Attached infor- mation	None					
Precautions/ Remarks	None					

*1. This applies to an NX-series EtherNet/IP Unit.

3-7-3 Other Troubles and Corrections

Problem	Correction
Tag data is not concurrent.	<p>Check the following items and correct the user program.</p> <ul style="list-style-type: none"> Data concurrency is maintained for each connection between the CPU Unit and the built-in EtherNet/IP port. To maintain data concurrency for tag data links, set a refreshing task for the network variables that are assigned to tags. Refer to information on the Concurrency of Tag Data Link Data in the <i>NJ/NX-series CPU Unit Built-in EtherNet/IP Port User's Manual (Cat. No. W506)</i> for details. Refer to the product manuals for products from other manufacturers.
At startup, some of the receive data is FALSE when it should be TRUE.	<ul style="list-style-type: none"> If the user program uses receive data, make sure that the All Tag Data Link Communications Status in communications status 1 or the Controller Operating Mode for the target node is TRUE before you use the receive data. To use operation information from the Controller, use Controller status in the tag sets on both the sending and receiving nodes. If the Fault Action setting of the output (produce) tag is enabled, The output (produce) data changes to FALSE when a fatal error occurs in the CPU Unit. Check the error status at the output (producing) Controller.
Tag data link communications are not stable.	<ul style="list-style-type: none"> For an NX701 CPU Unit, use a 1,000 Mbps Ethernet switch if 10 or 100 Mbps is set or if you are using a 10 Mbps repeater hub, a 100 Mbps repeater hub, or a 1,000 Mbps repeater hub. The performance of the tag data links assumes that an Ethernet switch is used to achieve a 40,000 pps bandwidth for full-duplex, 1,000 Mbps auto-negotiation communications. For an NX102 CPU Unit, use a 100 Mbps Ethernet switch if 10 Mbps is set or if you are using a 10 Mbps or 100 Mbps repeater hub. The performance of the tag data links assumes that an Ethernet switch is used to achieve a 12000 pps bandwidth for full-duplex, 100 Mbps auto-negotiation communications. For an NJ-series CPU Unit and an NX1P2 CPU Unit, use a 100 Mbps Ethernet switch if 100 Mbps is set or if you are using a 10 Mbps or 100 Mbps repeater hub. For unit version 1.03 or later, the performance of the tag data links assumes that an Ethernet switch is used to achieve a 3,000 pps bandwidth for full-duplex, 100 Mbps auto-negotiation communications. For unit version 1.00 to 1.02, a 1,000 pps bandwidth is assumed. Refer to <i>NJ/NX-series CPU Unit Built-in EtherNet/IP Port User's Manual (Cat. No. W506)</i> to access the error counters and discarded packed counters on the Ethernet Information Tab Page. Use the information to check for noise on the communications path, non-standard cables, damaged cables/connectors, unexpectedly high communications traffic, and incorrect loops in connections between Ethernet switches. Contact the Ethernet switch manufacturer if there are problems with the transfer capacity of the Ethernet switches in the communications path. If Ethernet switches are cascaded, the load may be concentrated on the middle Ethernet switches. Change the network configuration so that the load is not concentrated. Also, refer to <i>NJ/NX-series CPU Unit Built-in EtherNet/IP Port User's Manual (Cat. No. W506)</i> and use the connection status on the Connections Tab Page to remove the cause of the error according to information in 15-3-2 Connection Status Codes and Troubleshooting.

3-8 Errors in the EtherCAT Master Function Module

3-8-1 Error Tables

EtherCAT Master

Event code	Event name	Meaning	Assumed cause	Level					Reference
				M a j	P r t	M i n	O b s	I n f o	
04400000 hex	Communications Controller Error	A Communications Controller Error was detected at startup.	<ul style="list-style-type: none"> The Communications Controller failed. 		○				page 3-750
14400000 hex (Project Unit Ver. earlier than 1.40)	MAC Address Error	The MAC address is incorrect.	<ul style="list-style-type: none"> The CPU Unit has failed. 		○				page 3-750
34420000 hex (Ver. 1.40 or later)	Parameters Not Transferred	Slave or Unit parameter is not transferred.	Slave or Unit parameter is not downloaded.		○				page 3-751
44010000 hex	EtherCAT Fault	A fatal error was detected in the EtherCAT Master Function Module.	<ul style="list-style-type: none"> An error occurred in the software. 		○				page 3-752
84200000 hex	Link OFF Error	A Link OFF state occurred in the master.	<ul style="list-style-type: none"> The Ethernet cable is not connected between the master and the first slave. The power supply to the first slave is not turned ON. The Ethernet cable connector is disconnected between the master and the first slave. A non-recommended Ethernet cable is used between the master and first slave. The Ethernet cable is broken between the master and the first slave. The contact of the connector on the Ethernet cable between the master and the first slave is faulty, or parts are faulty. Hardware failure of the first slave An EtherCAT Frame Not Received (842E0000 hex) occurred. A general-purpose Ethernet hub or repeater hub is connected. 		○				page 3-753

Event code	Event name	Meaning	Assumed cause	Level					Reference
				M a j	P r t	M i n	O b s	I n f o	
842E0000 hex (Ver. 1.11 or later)	EtherCAT Frame Not Received	The sent EtherCAT frame was not re- ceived.	<ul style="list-style-type: none"> • A Unit other than an EtherCAT slave is connected. • Output ports are connected to each other between EtherCAT slaves or between the EtherCAT master and EtherCAT slaves. • The Ethernet cable connector is connected uncertainly between the EtherCAT master and EtherCAT slaves. • The contact of the Ethernet cable between the EtherCAT master and an EtherCAT slave is faulty, or the connector is faulty. • The transmission delay time calculated based on the set value of the total cable length is shorter than the actual transmission delay time. • An EtherCAT slave manufactured by a company other than OMRON is included in the network configuration, or a non-recommended Ethernet cable is intentionally used. • The network configuration has been changed from the network configuration when the transmission delay time was set, causing increase in transmission delay time. • Hardware failure of EtherCAT slave • Hardware failure of EtherCAT master • An Incorrect Wiring Detected (843C0000 hex) occurred. 						page 3-755
24200000 hex	Slave Node Address Du- plicated	The same slave ad- dress is used for two nodes.	<ul style="list-style-type: none"> • The same node address is set for more than one slave. 					○	page 3-758
34400000 hex	Network Configura- tion Informa- tion Error	There is an error in the network configu- ration information.	<ul style="list-style-type: none"> • The power supply to the Controller was interrupted or communications with the Sysmac Studio were disconnected while downloading or restoring the network configuration information is in progress. 					○	page 3-759

Event code	Event name	Meaning	Assumed cause	Level					Reference
				M a j	P r t	M i n	O b s	I n f o	
34410000 hex (Ver. 1.10 or later and Project Unit Ver. earlier than 1.40) [NX701, NX1P2]	EtherCAT Communica- tions Cycle Exceeded	Process data commu- nications could not be performed with the specified commu- nications cycle.	<ul style="list-style-type: none"> The transmission delay time in the actually connected configuration is longer than the transmission delay time calculated for the user-set cable length. The set task period or communications cycle is too short. 			○			page 3-760
84210000 hex (Project Unit Ver. earlier than 1.40)	Network Configura- tion Error	The EtherCAT net- work configuration is incorrect.	<ul style="list-style-type: none"> Slave output ports are connected to each other. The master and slave are connected with the slave output port. The number of connected slaves exceeded the maximum number of slaves for the EtherCAT master. 			○			page 3-761
84220000 hex (Project Unit Ver. earlier than 1.40)	Network Configura- tion Verifica- tion Error	A slave that is in the network configuration information is not connected. Or, a slave that is not in the network configuration information is con- nected.	<ul style="list-style-type: none"> A slave that is in the network configuration information is not connected. There is a node address mismatch. A different slave from the one that is specified in the network configuration information is connected. A slave that is not in the network configuration information is connected. The hardware switches for the slave node address were changed to a value other than 0 after the Write Slave Node Address operation was performed from the Sysmac Studio. The Ethernet cable is broken between two slaves. 			○			page 3-764

Event code	Event name	Meaning	Assumed cause	Level					Reference
				M a j	P r t	M i n	O b s	I n f o	
84230000 hex (Project Unit Ver. earlier than 1.40)	Slave Initiali- zation Error	Slave initialization failed.	<ul style="list-style-type: none"> An error occurred in EtherCAT master processing. An initialization error occurred in the EtherCAT slave. An initialization error occurred in the EtherCAT Coupler Unit. A major fault level Controller error occurred. The Ethernet cable is broken or the specified cable is not being used. A connector on the Ethernet cable is disconnected, the contact is faulty, or parts are faulty. A general-purpose Ethernet hub is connected. The master failed. The slave failed. Noise 			○			page 3-766
84280000 hex (Project Unit Ver. earlier than 1.40)	Slave Appli- cation Error	An error occurred in the slave application.	<ul style="list-style-type: none"> An error was detected in the slave's application layer status register. 			○			page 3-768
84290000 hex	Process Da- ta Transmis- sion Error	Sending process data failed.	<ul style="list-style-type: none"> It was not possible to send the EtherCAT frame during the EtherCAT communications period. The frame transmission jitter exceeded the limit. 			○			page 3-769

Event code	Event name	Meaning	Assumed cause	Level					Reference
				M a j	P r t	M i n	O b s	I n f o	
842B0000 hex	Process Data Reception Timeout	Process data reception timed out.	<ul style="list-style-type: none"> Noise A general-purpose Ethernet hub is connected. A non-recommended cable was used. The Ethernet cable connector is disconnected. The Ethernet cable is broken. The contact of the Ethernet cable connector is faulty, or parts are faulty. The transmission delay time calculated based on the set value of the total cable length is shorter than the actual transmission delay time. An EtherCAT slave manufactured by a company other than OMRON is included in the network configuration, or a non-recommended Ethernet cable is intentionally used. The network configuration has been changed from the network configuration when the transmission delay time was set, causing increase in transmission delay time. The CPU Unit task period is too short. A ring disconnection occurred in the ring topology for which a slave that does not support the ring topology is included. 						page 3-770
842C0000 hex (Project Unit Ver. earlier than 1.40)	Process Data Communications Error	An error occurred in process data communications.	<ul style="list-style-type: none"> A slave left the network even though the disconnection operation or disable operation was not performed. Slave failure 						page 3-773
842F0000 hex (Ver. 1.13 or later)	Input Process Data Invalid Error	Because the EtherCAT master could not perform process data communications normally when it was in the Operational state, the Input Data Invalid state continued for a certain period.	<ul style="list-style-type: none"> The Ethernet cable connector is connected uncertainly. The Ethernet cable is almost broken. The contact of the Ethernet cable connector is faulty, or parts are faulty. Hardware failure of EtherCAT slave Noise 						page 3-775

Event code	Event name	Meaning	Assumed cause	Level					Reference
				M a j	P r t	M i n	O b s	I n f o	
84300001 hex (Project Unit Ver. 1.40 or later)	Slave State Transition Failed	Slave state transition failed.	<ul style="list-style-type: none"> An error occurred in a slave during the EtherCAT slave state transition. A non-recommended cable was used. The Ethernet cable connector is disconnected. The Ethernet cable is broken. The contact of the Ethernet cable connector is faulty, or parts are faulty. A general-purpose Ethernet hub is connected. Noise The EtherCAT master or an EtherCAT slave failed. A slave returned an error response in the message communications that the EtherCAT master sent during EtherCAT slave state transition. The transition from Pre-Operational state to Safe-Operational state failed when the Module config send method parameter was set to Send for MDP-compatible slave. 						page 3-777
84310002 hex (Project Unit Ver. 1.40 or later)	Illegal Slave Disconnec- tion Detect- ed	The slave was dis- connected incorrec- tly.	<ul style="list-style-type: none"> The power supply to the slave is turned OFF, or an Ethernet cable is disconnected. The Ethernet cable connector is disconnected. A non-recommended cable was used. The Ethernet cable is broken. The contact of the Ethernet cable connector is faulty, or parts are faulty. The wiring of slaves in the ring topology is incorrect. The slave node address was changed during operation. 						page 3-781
84320003 hex (Project Unit Ver. 1.40 or later)	Network Configura- tion Verifica- tion Error (Unnecessa- ry Slave Connected)	A slave that is not in the network configu- ration information is connected.	<ul style="list-style-type: none"> A slave that is not in the network configuration information is connected. The maximum number of connected slaves was exceeded. The wiring of slaves in the ring topology is incorrect. 						page 3-783

Event code	Event name	Meaning	Assumed cause	Level					Reference
				M a j	P r t	M i n	O b s	I n f o	
84330004 hex (Project Unit Ver. 1.40 or later)	Network Configuration Verification Error (Mismatched Slave)	Slaves in the network configuration information and in the actual network configuration do not match.	<ul style="list-style-type: none"> There is a node address mismatch. A slave that is not in the network configuration information is connected. The wiring of slaves in the ring topology is incorrect. 			○			page 3-785
84340000 hex (Project Unit Ver. 1.40 or later)	Slave PDI WDT Error Detected	A slave PDI WDT error was detected.	<ul style="list-style-type: none"> EtherCAT slave power supply voltage dropped EtherCAT slave failure No reply from the slave (For slaves that are manufactured by other companies only) 			○			page 3-787
84360000 hex (Project Unit Ver. 1.40 or later)	Slave AL Status Error Detected	An AL status error was detected from an EtherCAT slave.	<ul style="list-style-type: none"> An error occurred on the EtherCAT slave side and the AL status code was reported by the EtherCAT slaves to the EtherCAT master. 			○			page 3-788
84370000 hex (Project Unit Ver. 1.40 or later)	Clock Synchronization Compensation Failed	Clock synchronization with slaves failed.	<ul style="list-style-type: none"> The network configuration was changed during state transition. EtherCAT slave failure Noise 			○			page 3-789
84380000 hex (Project Unit Ver. 1.40 or later)	Network Configuration Verification Error (Slave Unconnected)	A slave that is in the network configuration information is not connected.	<ul style="list-style-type: none"> The power supply to the slave is not turned ON. The Ethernet cable connector is disconnected between the slaves. The wait time for slave startup was exceeded because the link establishment was too slow or the power supply start-up of the slaves was too long. A non-recommended Ethernet cable is used to connect slaves. The Ethernet cable is broken between slaves. The contact of the connector on the Ethernet cable that connects slaves is faulty, or parts are faulty. The wiring of slaves in the ring topology is incorrect. Hardware failure of a slave 			○			page 3-790

Event code	Event name	Meaning	Assumed cause	Level					Reference
				M a j	P r t	M i n	O b s	I n f o	
843A0000 hex (Project Unit Ver. 1.40 or later)	Network Configuration Verification Error (Incorrect Ring Wiring)	The ring topology that is not set in the network configuration information, is configured on the actual network.	<ul style="list-style-type: none"> The ring topology configured on the actual network is not defined in the network configuration information. The ring topology is configured in a different position from one that is defined in the network configuration information. 			○			page 3-792
843C0000 hex (Project Unit Ver. 1.40 or later)	Incorrect Wiring Detected	The wiring of an EtherCAT network is incorrect.	<ul style="list-style-type: none"> Input ports or output ports are connected to each other. Two or more ring topologies are configured. The start port of the ring and the end port of the ring are not combined correctly. The wiring for the start port of the ring and one for the end port of the ring are reversed. The wiring of a Junction Slave in the ring topology is incorrect. A ring topology that is not in the network configuration information is on the actual network. 			○			page 3-794
94520000 hex (Project Unit Ver. 1.40 or later)	Wait for Cycling Power Supply	It is necessary to cycle the power supply to the Controller or reset the Controller for the recovery from an error.	<ul style="list-style-type: none"> An event, which is necessary to cycle the power supply or reset the Controller for the recovery, occurred. 			○			page 3-796

Event code	Event name	Meaning	Assumed cause	Level					Reference
				M a j	P r t	M i n	O b s	I n f o	
102F0000 hex (Ver. 1.03 or later and Project Unit Ver. earlier than 1.40)	EtherCAT Slave Back- up Failed	The backup operation for an EtherCAT slave ended in an error.	<ul style="list-style-type: none"> • There is no connection between the EtherCAT master and the slave (Link OFF). • An error caused an incorrect EtherCAT master status. • The EtherCAT network configuration information does not agree with the physical network configuration. • The request to the EtherCAT slave failed. • The EtherCAT master was temporarily unable to perform the processing because it was executing other processing. • Initialization of the EtherCAT slave failed. • It was not possible to read the backup parameters from the EtherCAT slave. • Communications with an OMRON Communications Coupler Unit or NX Unit failed. 				○		page 3-797

Event code	Event name	Meaning	Assumed cause	Level					Reference
				M a j	P r t	M i n	O b s	I n f o	
10300000 hex (Ver. 1.03 or later and Project Unit Ver. earlier than 1.40)	EtherCAT Slave Re- store Opera- tion Failed	The restore operation for an EtherCAT slave ended in an error.	<ul style="list-style-type: none"> There is no connection between the EtherCAT master and the slave (Link OFF). Wire the EtherCAT master and slave securely, and make sure that a connection is established before you attempt to restore the data. The EtherCAT network configuration information does not agree with the physical network configuration. The request to the EtherCAT slave failed. The EtherCAT master was temporarily unable to perform the processing because it was executing other processing. Initialization of the EtherCAT slave failed. It was not possible to write the backup parameters to the MX2/RX Series Inverter. (This applies only for unit version 1.10 or earlier of the CPU Unit.) It was not possible to write the backup parameters to the EtherCAT slave. Incorrect backup data was detected. The EtherCAT network configuration in the backup data does not agree with the physical network configuration. An error occurred at an OM-RON Communications Coupler Unit. 					○	page 3-799
10460001 hex (Project Unit Ver. 1.40 or later)	EtherCAT Slave Back- up Failed	The backup operation for an EtherCAT slave ended in an error.	<ul style="list-style-type: none"> The EtherCAT master cannot start backup. It was not possible to read the backup parameters to the EtherCAT slave. The request to the EtherCAT slave failed. Communications with an OM-RON Communications Coupler Unit or NX Unit failed. Backup was executed for a disconnected slave. 					○	page 3-802

Event code	Event name	Meaning	Assumed cause	Level					Reference
				M a j	P r t	M i n	O b s	I n f o	
10470002 hex (Project Unit Ver. 1.40 or later)	EtherCAT Slave Re- store Opera- tion Failed	The restore operation for an EtherCAT slave ended in an error.	<ul style="list-style-type: none"> The EtherCAT master cannot start restore operation. The EtherCAT network configuration in the backup data does not agree with the physical network configuration. It was not possible to write the backup parameters to the EtherCAT slave. The request to the EtherCAT slave failed. Incorrect backup data was detected. An error occurred at an OMRON Communications Coupler Unit. 				○		page 3-804
64200000 hex	Emergency Message Detected	An emergency mes- sage was detected.	<ul style="list-style-type: none"> An emergency message was received from a slave. 				○		page 3-807
842D0000 hex (Project Unit Ver. earlier than 1.40)	EtherCAT Message Er- ror	An error occurred in a message communi- cations with the slave.	<ul style="list-style-type: none"> Refer to the attached informa- tion to check the error. 				○		page 3-808
84350000 hex (Project Unit Ver. 1.40 or later)	Illegal Mail- box Re- ceived	An illegal mailbox was received from a slave.	<ul style="list-style-type: none"> A message with illegal destina- tion address was received from a slave. 				○		page 3-809
84390000 hex (Project Unit Ver. 1.40 or later)	Ring Discon- nection De- tected	A ring disconnection status was detected.	<ul style="list-style-type: none"> An Ethernet cable was discon- nected. An Ethernet cable connector is disconnected between the slaves. A non-recommended cable was used. The Ethernet cable is broken between slaves. The contact of the Ethernet ca- ble connector is faulty, or parts are faulty. 				○		page 3-810
94400000 hex	Slave Dis- connected	A slave was discon- nected for a discon- nection command.	<ul style="list-style-type: none"> An operation to disconnect the slave was executed from the Sysmac Studio. The EC_DisconnectSlave in- struction was executed. 				○		page 3-811
94410000 hex	Slave Con- nected	A slave was recon- nected for a recon- nection command.	<ul style="list-style-type: none"> An operation to reconnect the slave was executed from the Sysmac Studio. The EC_ConnectSlave instruc- tion was executed. 				○		page 3-812

Event code	Event name	Meaning	Assumed cause	Level					Reference
				M a j	P r t	M i n	O b s	I n f o	
94430000 hex	Error Reset	A command was received to reset errors.	<ul style="list-style-type: none"> An error reset operation was performed from the Sysmac Studio. The ResetECError instruction was executed. 					○	page 3-813
94440000 hex (Ver. 1.04 or later)	Slave Disabled	The EtherCAT Slave was disabled.	<ul style="list-style-type: none"> The EC_ChangeEnableSetting instruction was executed. 					○	page 3-814
94450000 hex (Ver. 1.04 or later)	Slave Enabled	The EtherCAT Slave was enabled.	<ul style="list-style-type: none"> The EC_ChangeEnableSetting instruction was executed. 					○	page 3-815
94500000 hex (Ver. 1.11 or later)	EtherCAT Diagnosis/Statistics Log Started	EtherCAT diagnosis/statistics log is started.	<ul style="list-style-type: none"> The value of the <code>_EC_StatisticsLogEnable</code> system-defined variable changed from FALSE to TRUE. 					○	page 3-816
94510000 hex (Ver. 1.11 or later)	EtherCAT Diagnosis/Statistics Log Ended	EtherCAT diagnosis/statistics log is ended.	<ul style="list-style-type: none"> An error that causes EtherCAT diagnosis/statistics log to end occurred. 					○	page 3-817

3-8-2 Error Descriptions

Built-in EtherCAT Port

Event name	Communications Controller Error		Event code	04400000 hex		
Meaning	A Communications Controller Error was detected at startup.					
Source	EtherCAT Master Function Module		Source details	Communica- tions port	Detection tim- ing	At power ON or Controller reset
Error attributes	Level	Partial fault	Recovery	Cycle the power supply or reset the Controller.	Log category	System
Effects	User program	Continues.	Operation	Master: The master waits in the Init state. Slave: Message communications and process data commu- nications are not possible.		
Indicators	EtherCAT NET RUN		EtherCAT NET ERR		EtherCAT LINK/ACT	
	---		Lights.		---	
System-de- fined variables	Variable		Data type		Name	
	_EC_LanHwErr		BOOL		Communications Controller Error	
Cause and cor- rection	Assumed cause		Correction		Prevention	
	The Communications Controller failed.		Reset the Controller. If the error persists, replace the CPU Unit.		None	
Attached infor- mation	None					
Precautions/ Remarks	None					

Event name	MAC Address Error		Event code	14400000 hex*1		
Meaning	The MAC address is incorrect.					
Source	EtherCAT Master Function Module		Source details	Communica- tions port	Detection tim- ing	At power ON or Controller reset
Error attributes	Level	Partial fault	Recovery	Cycle the power supply or reset the Controller.	Log category	System
Effects	User program	Continues.	Operation	Master: The master waits in the Init state. Slave: Message communications and process data commu- nications are not possible.		
Indicators	EtherCAT NET RUN		EtherCAT NET ERR		EtherCAT LINK/ACT	
	---		Lights.		---	
System-de- fined variables	Variable		Data type		Name	
	_EC_MacAdrErr		BOOL		MAC Address Error	
Cause and cor- rection	Assumed cause		Correction		Prevention	
	The CPU Unit has failed.		Replace the CPU Unit.		None	
Attached infor- mation	None					
Precautions/ Remarks	None					

*1. This event code occurs for project unit version earlier than 1.40.

Event name	Parameters Not Transferred		Event code	34420000 hex*1	
Meaning	Slave or Unit parameter is not transferred.				
Source	EtherCAT Master Function Module	Source details	Master	Detection timing	At power ON, Controller reset, or operating mode change
Error attributes	Level	Partial fault	Recovery	Cycle the power supply or reset the Controller.	Log category System
Effects	User program	Continues.	Operation	Master: The master waits in the Pre-operational state. Slave: Message communications are possible. Process data communications are not possible.	
Indicators	EtherCAT NET RUN		EtherCAT NET ERR		EtherCAT LINK/ACT
	---		Flashes at 1-s intervals.		---
System-defined variables	Variable		Data type		Name
	None		---		---
Cause and correction	Assumed cause		Correction		Prevention
	Slave or Unit parameter is not downloaded.		Cycle the power supply or reset the Controller after you download slave or Unit parameters from the Sysmac Studio.		If you execute the download that is required to reset the Controller, complete the download according to the message displayed on the Sysmac Studio.
Attached information	None				
Precautions/Remarks	None				

*1. This event code occurs for unit version 1.40 or later of the CPU Unit.

Event name	EtherCAT Fault		Event code	44010000 hex	
Meaning	A fatal error was detected in the EtherCAT Master Function Module.				
Source	EtherCAT Master Function Module		Source details	Master	Detection timing At power ON, at Controller reset, or during communications
Error attributes	Level	Partial fault	Recovery	Cycle the power supply or reset the Controller.	Log category System
Effects	User program	Continues.	Operation	<p>Master: The EtherCAT Master Function Module stops.</p> <p>Slave: Message communications and process data communications stop. During communications, a communications error occurs. The error is processed according to settings in the slave.</p> <p>An error occurs. The error is processed according to settings in the slave.</p>	
Indicators	EtherCAT NET RUN		EtherCAT NET ERR		EtherCAT LINK/ACT
	---		Lights.		---
System-defined variables	Variable		Data type		Name
	None		---		---
Cause and correction	Assumed cause		Correction		Prevention
	An error occurred in the software.		Obtain the Sysmac Controller log on the Sysmac Studio and contact your OMRON representative. Refer to the <i>Sysmac Studio Version 1 Operation Manual (Cat. No. W504)</i> for how to obtain the Sysmac Controller logs.		None
Attached information	Attached information 1: System information Attached information 2: System information Attached information 3: System information Attached information 4: System information				
Precautions/Remarks	None				

Event name	Link OFF Error		Event code	84200000 hex	
Meaning	A Link OFF state occurred in the master.				
Source	EtherCAT Master Function Module	Source details	Communica- tions port	Detection tim- ing	At power ON, at Controller reset, or during com- munications
Error attributes	Level	Partial fault	Recovery	Error reset	Log category System
Effects	User program	Continues.	Operation	<p>Master: The master waits in the Init state. If the master is not in the Init state, it changes to the Init state. Other communications errors caused by this error are not detected as an error.</p> <p>Slave: Message communications and process data communications stop. During communications, a communications error occurs. The error is processed according to settings in the slave.</p>	
Indicators	EtherCAT NET RUN		EtherCAT NET ERR		EtherCAT LINK/ACT
	Not lit		Flashes at 1-s intervals.		---
System-de- fined variables	Variable	Data type		Name	
	_EC_LinkOffErr	BOOL		Link OFF Error	
	_EC_LinkStatus	BOOL		Link Status	

Cause and correction	Assumed cause	Correction	Prevention
	The Ethernet cable is not connected between the master and the first slave.	Connect the Ethernet cable between the master and the first slave.	Confirm that the Ethernet cable is connected.
	The power supply to the first slave is not turned ON.	Turn ON the supply power to the first slave.	Confirm that the power supply to the first slave is turned ON.
	The Ethernet cable connector is disconnected between the master and the first slave.	Connect the Ethernet cable connector.	<ul style="list-style-type: none"> Firmly connect the Ethernet cable connector until it clicks into place. Confirm that the Ethernet cable connector is mated securely.
	A non-recommended Ethernet cable is used between the master and first slave.	Replace the Ethernet cable with a recommended one.	Use the recommended Ethernet cables.
	The Ethernet cable is broken between the master and the first slave.	Replace the Ethernet cable.	Before you start wiring Ethernet cables, use the cable tester or other devices to confirm that there is no broken cable. Refer to the EtherCAT Network Wiring in <i>NJ/NX-series CPU Unit Built-in EtherCAT Port User's Manual (Cat. No. W505)</i> for precautions on wiring.
	The contact of the connector on the Ethernet cable between the master and the first slave is faulty, or parts are faulty.	Replace the Ethernet cable.	None
	Hardware failure of the first slave	If this error persists even after you cycle the power supply to the first slave, replace the slave.	None
	An EtherCAT Frame Not Received (842E0000 hex) occurred.*1	Make the corrections for an EtherCAT Frame Not Received (842E0000 hex).	Implement preventive measures for an EtherCAT Frame Not Received (842E0000 hex).
	A general-purpose Ethernet hub or repeater hub is connected.	Remove the general-purpose Ethernet hub or repeater hub, and connect an EtherCAT Junction Slave.	Do not connect the general-purpose Ethernet hub and repeater hub. Use an EtherCAT Junction Slave when you want to configure a topology with branching or a ring topology.
Attached information	None		
Precautions/Remarks	When the general-purpose Ethernet hub or repeater hub is connected, the EtherCAT master stops EtherCAT communications to prevent network malfunctions, and this error may occur.		

*1. Use the troubleshooting functions of the Sysmac Studio or the Troubleshooter of an HMI to check the error.

Event name	EtherCAT Frame Not Received		Event code	842E0000 hex* ¹	
Meaning	The sent EtherCAT frame was not received.				
Source	EtherCAT Master Function Module	Source details	Master/Slave	Detection timing	At power ON, at Controller reset, during communications* ² , or when a cable is connected to EtherCAT master
Error attributes	Level	Partial fault	Recovery	Error reset* ³	Log category System
Effects	User program	Continues.	Operation	<p>Master: If the master waits in the Init state or is not in the Init state, it changes all slaves to the Init state.</p> <p>Slave: Message communications and process data communications stop. During communications, a communications error occurs. The error is processed according to settings in the slave.</p>	
Indicators	EtherCAT NET RUN		EtherCAT NET ERR		EtherCAT LINK/ACT
	---		Flashes at 1-s intervals.		Flashes
System-defined variables	Variable		Data type		Name
	None		---		---
Cause and correction	Assumed cause		Correction		Prevention
	One of the following 1) to 10) occurred.		Identify the error location and make the correction according to the attached information. If this error occurred in two locations in the ring topology, make the corrections for the location that is not end port of the ring. If the error location cannot be identified by the attached information due to the node address setting not being made or other causes, check that there is no error for each slave and cable.		
	1) A device other than an EtherCAT slave is connected.		Remove the device other than an EtherCAT slave.		Confirm that devices other than EtherCAT slaves are not connected to the EtherCAT network.
	2) Output ports are connected to each other between EtherCAT slaves or between the EtherCAT master and EtherCAT slaves.		Correct the connection of the Ethernet cable that is connected to the relevant port of the slave or master which is shown in the attached information 3.		Confirm that there are no incorrect Ethernet cable connections.
	3) The Ethernet cable connector is connected uncertainly between the EtherCAT master and EtherCAT slaves.		Connect the Ethernet cable connector.		<ul style="list-style-type: none"> Firmly connect the Ethernet cable connector until it clicks into place. Confirm that the Ethernet cable connector is mated securely.
	4) The contact of the Ethernet cable between the EtherCAT master and an EtherCAT slave is faulty, or the connector is faulty.		Replace the Ethernet cable.		None

	<p>5) The transmission delay time calculated based on the set value of the total cable length is shorter than the actual transmission delay time.</p>	<p>Set a larger value in Total Cable Length and transfer the setting to the Controller.</p> <p>Or, change the set value in Transmission Delay Time with the measured value, and transfer the setting to the Controller. For the procedure to update the Transmission Delay Time with the measured value, refer to <i>Setting Transmission Delay Time by Actual Measurement</i> in the <i>NJ/NX-series CPU Unit Built-in EtherCAT Port User's Manual (Cat. No. W505)</i>.</p>	<p>Same as the Correction.</p>
	<p>6) An EtherCAT slave manufactured by a company other than OMRON is included in the network configuration, or a non-recommended Ethernet cable is intentionally used.</p>		
	<p>7) The network configuration has been changed from the network configuration when the transmission delay time was set, causing increase in transmission delay time.</p>		
	<p>8) Hardware failure of EtherCAT slave</p>	<p>If this error persists even after you cycle the power supply to the relevant slave, replace the slave.</p>	<p>None</p>
	<p>9) Hardware failure of EtherCAT master</p>	<p>If this error persists even after you cycle the power supply to the CPU Unit, replace the CPU Unit.</p>	<p>None</p>
	<p>10) An Incorrect Wiring Detected (843C0000 hex) occurred.*4</p>	<p>Make the corrections for an Incorrect Wiring Detected (843C0000 hex).</p>	<p>Implement preventive measures for an Incorrect Wiring Detected (843C0000 hex).</p>
<p>Attached information</p>	<p>Attached information 1: Error location diagnostic result</p> <ul style="list-style-type: none"> • 0: Error location is not identified ^{Note 1} • 1: Error location is identified ^{Note 1} • 2: Error location is being identified ^{Note 1 Note 2} <p>Note 1. The EtherCAT related functions in the Sysmac Studio and EtherCAT communications instructions cannot be executed.</p> <p>Note 2. The Clear All Memory operation of the CPU Unit and project download cannot be executed until this event in which the attached information 1 is 0 or 1 is registered.</p> <p>Attached Information 2: Error Location (only when the value of attached information 1 is 1). ^{Note 3}</p> <ul style="list-style-type: none"> • 0: Master • Not 0: Slave node address <p>Attached Information 3: Error Location Details (only when the value of attached information 1 is 1). ^{Note 3}</p> <ul style="list-style-type: none"> • If the attached information 2 is the master, 0 is output as the port name. • If the attached information 2 is the slave node address, the port name that is displayed on the Support Software is output. However, if the network configuration information does not agree with the physical network configuration of the relevant slave, any of PortA, PortB, PortC, and PortD is output as the default as the port name. • If the value of attached information 1 is not 1, 0 is output as the port name. <p>Note 3. If there is a ring topology in the actual network, the error location may not be displayed correctly. If there is no problem on the error location displayed in the attached information 2, and 3, temporarily remove the cable on the end port of the ring, cycle the power supply to the Controller or reset the Controller, and then make the corrections for the event occurred.</p> <p>Attached information 4: System information</p>		

Precautions/ Remarks	<ul style="list-style-type: none"> • For project unit version earlier than 1.42, the error location cannot be identified if there is a ring topology in the actual network configuration. Remove the cable on the end port of the ring, cycle the power supply to the Controller or reset the Controller, and then make an occurrence of this error again to identify the error location. • For project unit version 1.42 or later, when this error occurred in two locations in the ring topology, make the corrections for the location that is not end port of the ring. • The attached information 1 becomes 2 only for the project unit version 1.40 or later.
---------------------------------	--

- *1. This event code occurs for unit version 1.11 or later of the CPU Unit.
- *2. This is detected for project unit version 1.40 or later.
- *3. For project unit version 1.40 or later, it may be necessary to cycle the power supply.
- *4. Use the troubleshooting functions of the Sysmac Studio or the Troubleshooter of an HMI to check the error.

Event name	Slave Node Address Duplicated		Event code	24200000 hex		
Meaning	The same slave address is used for two nodes.					
Source	EtherCAT Master Function Module		Source details	Slave	Detection timing	At power ON, at Controller reset, or during communications
Error attributes	Level	Minor fault	Recovery	Error reset	Log category	System
Effects	User program	Continues.	Operation	<p>Master:</p> <p>If the Error Is Detected When the Master Is Started Communications stop. The master waits in the Init state.</p> <p>When the Fail-soft Operation Is Set to <i>Fail-soft</i> and the Error Is Detected during Operation Slaves that were normal continue to operate. Slaves after the new slave that caused the duplicated address error remain in the Init state.</p> <p>When the Fail-soft Operation Is Set to <i>Stop</i> and the Error Is Detected during Operation For project unit version earlier than 1.40: The master changes the slaves that were normal to the Pre-Operational state. Slaves after the new slave that caused the duplicated address error remain in the Init state.</p> <p>For project unit version 1.40 or later: The master changes the slaves that were normal to the Safe-Operational state. Slaves after the new slave that caused the duplicated address error remain in the Init state.</p> <p>Slave:</p> <p>No error occurred.</p> <p>For slaves after the new slave that caused the duplicated address error, message communications and process data communications are not possible.</p>		
Indicators	EtherCAT NET RUN		EtherCAT NET ERR		EtherCAT LINK/ACT	
	---		Flashes at 1-s intervals.		---	
System-defined variables	Variable	Data type	Name			
	_EC_SlavAdrDupErr	BOOL	Slave Node Address Duplicated Error			
Cause and correction	Assumed cause	Correction	Prevention			
	The same node address is set for more than one slave.	Check the node address switch or node address set value of the slave, and change it to prevent address duplication.	Set the node address of the slave to prevent duplication.			
Attached information	None					
Precautions/Remarks	The slave cannot be used unless the slave node address is set.					

Event name	Network Configuration Information Error		Event code	34400000 hex	
Meaning	There is an error in the network configuration information.				
Source	EtherCAT Master Function Module		Source details	Master	Detection timing At power ON or Controller reset
Error attributes	Level	Minor fault	Recovery	Automatic recovery	Log category System
Effects	User program	Continues.	Operation	Master: The master waits in the Init state. Slave: Message communications and process data communications are not possible.	
Indicators	EtherCAT NET RUN		EtherCAT NET ERR		EtherCAT LINK/ACT
	---		Flashes at 1-s intervals.		---
System-defined variables	Variable		Data type		Name
	_EC_NetCfgErr		BOOL		Network Configuration Information Error
Cause and correction	Assumed cause		Correction		Prevention
	The power supply to the Controller was interrupted or communications with the Sysmac Studio were disconnected while downloading or restoring the network configuration information is in progress.		Perform the Clear All Memory operation and then download or restore the network configuration information to the master again.		Do not turn OFF the power supply to the Controller and disconnect communications with the Sysmac Studio while downloading or restoring the network configuration information.
Attached information	Attached Information 1: Error Details (0001 hex: Illegal parameter, 0014 hex: Error opening file)				
Precautions/Remarks	None				

Event name	EtherCAT Communications Cycle Exceeded		Event code	34410000 hex*1		
Meaning	Process data communications could not be performed with the specified communications cycle.					
Source	EtherCAT Master Function Module		Source details	Master	Detection timing	At start of communications
Error attributes	Level	Minor fault	Recovery	Automatic recovery	Log category	System
Effects	User program	Continues.	Operation	Master: The master waits in the Init state. Slave: Message communications and process data communications are not possible.		
Indicators	EtherCAT NET RUN		EtherCAT NET ERR		EtherCAT LINK/ACT	
	---		Flashes at 1-s intervals.		---	
System-defined variables	Variable	Data type		Name		
	_EC_CycleExceeded	BOOL		EtherCAT Communications Cycle Exceeded		
Cause and correction	Assumed cause		Correction		Prevention	
	The transmission delay time in the actually connected configuration is longer than the transmission delay time calculated for the user-set cable length.		Set the cable length so that it agrees with the actual configuration.		Set the cable length so that it agrees with the actual configuration.	
	The set task period or communications cycle is too short.		Use the Simulator and set a task period (communications cycle) that enables communications.		Use the Simulator and set a task period (communications cycle) that enables communications.	
Attached information	None					
Precautions/Remarks	None					

*1. This event code occurs for a CPU Unit with unit version 1.10 or later and project unit version earlier than 1.40.

Event name	Network Configuration Error		Event code	84210000 hex*1		
Meaning	The EtherCAT network configuration is incorrect.					
Source	EtherCAT Master Function Module	Source details	Master	Detection timing	At power ON, at Controller reset, or during communications	
Error attributes	Level	Minor fault	Recovery	Error reset	Log category	System
Effects	User program	Continues.	Operation	Refer to Precautions/Remarks.		
Indicators	EtherCAT NET RUN		EtherCAT NET ERR		EtherCAT LINK/ACT	
	---		Flashes at 1-s intervals.		---	
System-defined variables	Variable		Data type		Name	
	_EC_NetTopologyErr		BOOL		Network Configuration Error	
Cause and correction	Assumed cause		Correction		Prevention	
	Slave output ports are connected to each other.		Correct the Ethernet cable connections.		Confirm that there are no incorrect Ethernet cable connections.	
	The master and slave are connected with the slave output port.					
	The number of connected slaves exceeded the maximum number of slaves for the EtherCAT master.		Disconnect unnecessary slaves and keep the number below the maximum number.		Confirm that no more than the maximum number of slaves are connected to the EtherCAT network.	
Attached information	Error Details: 0000 hex: Too many slaves, 0001 hex: Output ports connected to each other					

Precautions/ Remarks	<p>Operation</p> <p>Master:</p> <ul style="list-style-type: none"> • The following applies if fail-soft operation is set to <i>Fail-soft</i>, the event was detected when the power supply was turned ON or the Controller was reset, and the error details in the attached information is 0000 hex: The master will change the maximum number of slaves from the beginning to the Operational state and continues to operate. The slaves past the maximum number of slaves will remain in the Init state and communications will stop. • The following applies if fail-soft operation is set to <i>Stop</i>, the event was detected when the power supply was turned ON or the Controller was reset, and the error details in the attached information is 0000 hex: The master will change the maximum number of slaves from the beginning to the Pre-Operational state and only message communications will continue. The slaves past the maximum number of slaves will remain in the Init state and communications will stop. • The following applies if the event was detected when the power supply was turned ON or the Controller was reset, and the error details in the attached information is 0001 hex: All slaves will remain in the Init state and communications will stop. • The following applies if fail-soft operation is set to <i>Fail-soft</i>, the event was detected during communications, and the error details in the attached information is 0000 hex: The master will change the maximum number of slaves from the beginning to the Operational state and continues to operate. The slaves past the maximum number of slaves will remain in the Init state and communications will stop. • The following applies if fail-soft operation is set to <i>Stop</i>, the event was detected during communications, and the error details in the attached information is 0000 hex: The master will change the maximum number of slaves from the beginning to the Pre-Operational state and communications will stop. The slaves past the maximum number of slaves will remain in the Init state and communications will stop. • The following applies if fail-soft operation is set to <i>Fail-soft</i>, the event was detected during communications, and the error details in the attached information is 0001 hex: The slaves that are normal continue to operate. If you are using distributed clocks to synchronize the slaves, a Synchronization Error may occur between the slaves. <p>Slave:</p> <ul style="list-style-type: none"> • No error occurred. • The following applies if fail-soft operation is set to <i>Fail-soft</i>, the event was detected when the power supply was turned ON or the Controller was reset, and the error details in the attached information is 0000 hex: The maximum number of slaves from the beginning are in the Operational state and both message communications and process data communications will continue. The slaves past the maximum number of slaves will remain in the Init state and both message communications and process communications will stop. • The following applies if fail-soft operation is set to <i>Stop</i>, the event was detected when the power supply was turned ON or the Controller was reset, and the error details in the attached information is 0000 hex: The maximum number of slaves from the beginning are in the Pre-Operational state and message communications will continue, but process data communications will stop. The slaves past the maximum number of slaves will remain in the Init state and both message communications and process communications will stop. • The following applies if the event was detected when the power supply was turned ON or the Controller was reset, and the error details in the attached information is 0001 hex: All slaves will remain in the Init state and both message communications and process data communications will stop.
---------------------------------	--

	<ul style="list-style-type: none"> • The following applies if fail-soft operation is set to <i>Fail-soft</i>, the event was detected during communications, and the error details in the attached information is 0000 hex: The slaves before the node where the error occurred are in the Operational state and both message communications and process data communications will continue. The slave where the error occurred and all slaves after it will remain in the Init state and both message communications and process data communications will stop. • The following applies if fail-soft operation is set to <i>Stop</i>, the event was detected during communications, and the error details in the attached information is 0000 hex: Message communications will be possible, but process data communications will not, for all slaves in the Pre-Operational state. Both message communications and process data communications will not be possible for all slaves in the Init state. • The following applies if fail-soft operation is set to <i>Fail-soft</i>, the event was detected during communications, and the error details in the attached information is 0001 hex: Process data communications will be possible for all slaves that are operating normally. If you are using distributed clocks to synchronize the slaves and a Synchronization Error is detected, only input refreshing is enabled. Message communications will be possible.
	<p>There are restrictions on the number of slave node addresses, and not on the number of slaves. This is because there are slaves, such as Junction Slaves, that use more than one node.</p> <p>Also, if the maximum number of slaves are connected and an attempt is made to make a ring connection, a Too Many Slaves error (0000 hex) occurs.</p>

*1. This event code occurs for project unit version earlier than 1.40.

Event name	Network Configuration Verification Error		Event code	84220000 hex ^{*1}		
Meaning	A slave that is in the network configuration information is not connected. Or, a slave that is not in the network configuration information is connected.					
Source	EtherCAT Master Function Module		Source details	Master/Slave	Detection timing	At power ON, at Controller reset, or during communications
Error attributes	Level	Minor fault	Recovery	Error reset	Log category	System
Effects	User program	Continues.	Operation	<p>When Fail-soft Operation Is Set to <i>Fail-soft</i></p> <p>Master: The master changes slaves that are consistent with the network configuration information to the Operational state. Slaves that are not consistent with the network configuration information and all subsequent slaves remain in the Init state.</p> <p>Slave: Depends on the slave communications status.</p> <p>When Fail-soft Operation Is Set to <i>Stop</i></p> <p>Master: The master changes slaves that are consistent with the network configuration information to the Pre-Operational state. Slaves that are not consistent with the network configuration information and all subsequent slaves remain in the Init state.</p> <p>Slave: Depends on the slave communications status.</p>		
Indicators	EtherCAT NET RUN		EtherCAT NET ERR		EtherCAT LINK/ACT	
	---		Flashes at 1-s intervals.		---	
System-defined variables	Variable		Data type		Name	
	_EC_NetCfgCmpErr		BOOL		Network Configuration Verification Error	
	When Inconsistencies Are Found in Verification _EC_CommErrTbl		ARRAY [1..n] OF BOOL ^{*2}		Communications Error Slave Table	

Cause and correction	Assumed cause	Correction	Prevention
	A slave that is in the network configuration information is not connected.	Connect the slave that is specified in the network configuration information. Or, connect the Sysmac Studio and set and save the network configuration information with the slave deleted in the master.	Set and save the network configuration information for the configuration actually connected in the master.
	There is a node address mismatch.	Make the slave node address settings consistent with the network configuration information.	
	A different slave from the one that is specified in the network configuration information is connected.	Connect the slave that is specified in the network configuration information. Or, connect the Sysmac Studio and set and save the network configuration information with the correct slaves in the master.	
	A slave that is not in the network configuration information is connected.	Disconnect the slave that is not in the network configuration information from the network. Or, connect the Sysmac Studio and set and save the network configuration information with the slave added in the master.	
	The hardware switches for the slave node address were changed to a value other than 0 after the Write Slave Node Address operation was performed from the Sysmac Studio.	To use the value that is set on the hardware switches, reset the error. When the error is reset, there will be a disagreement between the hardware switches and the value that was written from the Sysmac Studio. A Slave Application Error (84280000 hex) will occur and you must then reset the error again. If this error occurs when the slave is disconnected or disabled, reset the error first and then connect or enable the slave. When you do, a Slave Application Error (84280000 hex) will occur. Reset the error again and then connect or enable the slave. To use the node address that was set in the Write Slave Node Address from the Sysmac Studio, set the hardware switches to a node address of 0 and cycle the power supply to the slave.	
	The Ethernet cable is broken between two slaves.	In cases not caused by the above causes, confirm the location of the break in the Ethernet cable and replace the cable.	None
Attached information	None		
Precautions/Remarks	If you add check items in the options for network configuration verification, check whether the items match.		

*1. This event code occurs for project unit version earlier than 1.40.

*2. "n" is 512 for an NX-series CPU Unit and 192 for the NX102, NX1P2, and NJ-series CPU Units.

Event name	Slave Initialization Error		Event code	84230000 hex ^{*1}		
Meaning	Slave initialization failed.					
Source	EtherCAT Master Function Module		Source details	Master/Slave	Detection timing	At power ON, Controller reset, error reset, or major fault level Controller error
Error attributes	Level	Minor fault	Recovery	Error reset	Log category	System
Effects	User program	Continues.	Operation	<p>When Fail-soft Operation Is Set to <i>Fail-soft</i></p> <p>Master:</p> <ul style="list-style-type: none"> When the master failed to change from the Init state to the Pre-Operational state: Communications stop in the Init state at the slave where the error occurred. Slaves in topology up to the slave where the error occurred change to the Operational state and continue to operate. When the master fails to change states after Pre-Operational state: Only the slave with the error will stop state transitions. Other normal slaves change to the Operational state and continue to operate. <p>Slave: This depends on the slave communications status.</p> <p>When Fail-soft Operation Is Set to <i>Stop</i></p> <p>Master:</p> <ul style="list-style-type: none"> When the master failed to change from the Init state to the Pre-Operational state: The master changes all slaves to the Init state and communications stop. When the master fails to change states after Pre-Operational state: The master changes all slaves to the Pre-Operational state and communications stop. <p>Slave: This depends on the slave communications status.</p>		
Indicators	EtherCAT NET RUN		EtherCAT NET ERR		EtherCAT LINK/ACT	
	---		Flashes at 1-s intervals.		---	
System-defined variables	Variable	Data type		Name		
	_EC_SlavInitErr	BOOL		Slave Initialization Error		
	_EC_CommErrTbl	ARRAY [1..n] OF BOOL ^{*2}		Communications Error Slave Table		
Cause and correction	Assumed cause		Correction		Prevention	
	An error occurred in EtherCAT master processing.		Connect the Sysmac Studio and reconfigure and save the network configuration information in the master again. If this error occurs again, check that there are no errors in the slave synchronization settings and the PDO mapping information, and correct any errors that are found.		Correctly set the slave synchronization settings, PDO mapping information, and configure and save network configuration information in the master.	

	An initialization error occurred in the EtherCAT slave.	The Module config send method parameter is sometimes displayed for a slave in the EtherCAT network configuration on the Sysmac Studio even if a send method cannot be set. If that occurs, set the Module config send method parameter to Do not send and perform synchronization again. Or, cycle the power supply to the EtherCAT slave. If this error persists, replace the EtherCAT slave.	None
	An initialization error occurred in the EtherCAT Coupler Unit.	Connect the Sysmac Studio to the USB port on the EtherCAT Coupler Unit, check the error details, and take suitable measures for the error.	None
	A major fault level Controller error occurred.	If a major fault level Controller error occurs, process data communications stop. If a Slave Application Error (84280000 hex) occurs at this time, this event also occurs. Perform corrections for the major fault level Controller error.	Perform preventive measures for major fault level Controller errors.
	The transmission delay time calculated based on the set value of the total cable length is shorter than the actual transmission delay time.	Set a larger value in Total Cable Length and transfer the setting to the Controller. If the total length of the cables is 1000m or less, set the initial value (1000m) for the Total Cable Length .	Same as the Correction.
	The Ethernet cable is broken or the specified cable is not being used.	The causes given on the left are possible if the error occurs from when the system starts operation or if it always occurs after a specific time after the system starts operation. Use the diagnostic and statistical information from the Sysmac Studio and check the EtherCAT communications status. If the Ethernet cable between the master and slave is broken or if the specified cable was not used, replace the cable. Or, reconnect the connector and make sure it is mated correctly. If a general-purpose Ethernet hub is connected, replace it with an EtherCAT Junction Slave. If the CPU Unit or an EtherCAT slave fails, replace it.	Make sure that the cable is not broken and use the specified cable.
	A connector on the Ethernet cable is disconnected, the contact is faulty, or parts are faulty.		Confirm that the Ethernet cable connector is mated securely.
	A general-purpose Ethernet hub is connected.		When branching an EtherCAT network, use an EtherCAT Junction Slave.
	The master failed.		None
	The slave failed.		None
	Noise		If this error occurs irregularly, implement noise countermeasures.
Attached information	Attached information 1: System information 1 Attached information 2: System information 2 Attached information 3: System information 3 Attached information 4: System information 4		

Precautions/Remarks	None
----------------------------	------

*1. This event code occurs for project unit version earlier than 1.40.

*2. "n" is 512 for an NX-series CPU Unit and 192 for the NX102, NX1P2, and NJ-series CPU Units.

Event name	Slave Application Error		Event code	84280000 hex ^{*1}	
Meaning	An error occurred in the slave application.				
Source	EtherCAT Master Function Module		Source details	Slave	Detection timing During communications
Error attributes	Level	Minor fault	Recovery	Error reset	Log category System
Effects	User program	Continues.	Operation	<p>When Fail-soft Operation Is Set to <i>Fail-soft</i> Master: The slave communications status is not manipulated, but operation continues. The status of slaves with an application layer status error is also not manipulated. Slave: An error occurred. Operation is according to the state transition behavior of the slave where the error occurred.</p> <p>When Fail-soft Operation Is Set to <i>Stop</i> Master: The master changes all slaves to the Pre-Operational state when an application layer status error occurs. Slave: An error occurred. All slaves change to the Pre-Operational state.</p>	
Indicators	EtherCAT NET RUN		EtherCAT NET ERR		EtherCAT LINK/ACT
	---		Flashes at 1-s intervals.		---
System-defined variables	Variable	Data type		Name	
	_EC_SlavAppErr	BOOL		Slave Application Error	
	_EC_CommErrTbl	ARRAY [1..n] OF BOOL ^{*2}		Communications Error Slave Table	
Cause and correction	Assumed cause		Correction		Prevention
	An error was detected in the slave's application layer status register.		Reset the error from the EtherCAT slave where the application error occurred. Use the procedure given in the slave documentation.		None
Attached information	Attached information 1: AL status code for the slave where the error was detected.				
Precautions/Remarks	None				

*1. This event code occurs for project unit version earlier than 1.40.

*2. "n" is 512 for an NX-series CPU Unit and 192 for the NX102, NX1P2, and NJ-series CPU Units.

Event name	Process Data Transmission Error		Event code	84290000 hex	
Meaning	Sending process data failed.				
Source	EtherCAT Master Function Module		Source details	Master	Detection timing During communications
Error attributes	Level	Minor fault	Recovery	Error reset	Log category System
Effects	User program	Continues.	Operation	<p>When Fail-soft Operation Is Set to <i>Fail-soft</i> Master: Operation continues. Slave: An error may occur in synced slaves. The error is processed according to settings in the slave.</p> <p>When Fail-soft Operation Is Set to <i>Stop</i> For project unit version earlier than 1.40: Master: The master changes all slaves to the Pre-Operational state. Slave: An error may occur in synced slaves. The error is processed according to settings in the slave.</p> <p>For project unit version 1.40 or later: Master: The master changes all slaves to the Safe-Operational state. Slave: An error may occur in synced slaves. The error is processed according to settings in the slave.</p>	
Indicators	EtherCAT NET RUN		EtherCAT NET ERR		EtherCAT LINK/ACT
	---		Flashes at 1-s intervals.		---
System-defined variables	Variable		Data type		Name
	_EC_PDSendErr		BOOL		Process Data Transmission Error
Cause and correction	Assumed cause		Correction		Prevention
	It was not possible to send the EtherCAT frame during the EtherCAT communications cycle. (When attached information 1 is 0000 hex) The frame transmission jitter exceeded the limit. (When attached information 1 is 0001 hex)		Connect the Sysmac Studio, increase the task period setting of the primary periodic task or priority-5 periodic task, and set and save the network configuration information in the EtherCAT master.		Set the task period of the primary periodic task or priority-5 periodic task to a value that provides sufficient processing time. Use the Simulator to check the necessary EtherCAT communications period.
Attached information	Attached Information 1: Error Details <ul style="list-style-type: none"> • 0000 hex: Frame generation was late for the transmission timing. • 0001 hex: The transmission jitter exceeded the limit. Attached information 2: System information				
Precautions/Remarks	None				

Event name	Process Data Reception Timeout		Event code	842B0000 hex	
Meaning	Process data reception timed out.				
Source	EtherCAT Master Function Module	Source details	Master	Detection timing	During communications
Error attributes	Level	Minor fault	Recovery	Error reset	Log category
Effects	User program	Continues.	Operation	<p>When Fail-soft Operation Is Set to <i>Fail-soft</i></p> <p>Master: Operation continues. Slave: An error may occur. The error is processed according to settings in the slave.</p> <p>When Fail-soft Operation Is Set to <i>Stop</i></p> <p>For project unit version earlier than 1.40: Master: The master changes all slaves to the Pre-Operational state. Slave: Process data communications stop. The output is processed according to settings in the slave.</p> <p>For project unit version 1.40 or later: Master: The master changes all slaves to the Safe-Operational state. Slave: Process data communications for output stop. The output is processed according to settings in the slave.</p>	
Indicators	EtherCAT NET RUN	EtherCAT NET ERR		EtherCAT LINK/ACT	
	---	Flashes at 1-s intervals.		---	
System-defined variables	Variable	Data type		Name	
	_EC_PDTimeoutErr	BOOL		Process Data Reception Timeout Error	

Cause and correction	Assumed cause	Correction	Prevention
	<p>One of the following 1) to 11) occurred.</p> <p>Check the following items in the diagnostic and statistical information.</p> <ul style="list-style-type: none"> • The CRC error frames received in the master diagnostic and statistical information • The frame reception timeout count in the master diagnostic and statistical information • The number of error frames in the slave diagnostic and statistical information <p>When the following is true, the factor may be 1).</p> <ul style="list-style-type: none"> • The count of CRC error frames received in the master diagnostic and statistical information increases. <p>In the following case, you can find the assumed causes of 2) to 6).</p> <ul style="list-style-type: none"> • The count of CRC error frames received in the master diagnostic and statistical information does not increase. • The frame reception timeout count in the master diagnostic and statistical information increases. • Acquisition of the number of error frames in the slave diagnostic and statistical information failed. 		
	1) Noise	Implement countermeasures that are appropriate for the source of the noise. Then, make sure that CRC error frames received are no longer counted in the master diagnostic and statistical information. Refer to the user's manuals for the Units for how to implement noise countermeasures.	If CRC error frames received are still counted in the master diagnostic and statistical information, remove the noise source or implement noise countermeasures while checking the slave diagnostic and statistical information. Even if you cannot remove the effect of noise completely, increase the Process Data Reception Timeout value when you want that an event is not reported.
	2) A general-purpose Ethernet hub is connected.	Replace it with an EtherCAT Junction Slave.	When branching an EtherCAT network, use an EtherCAT Junction Slave.
	3) A non-recommended cable was used.	Replace the Ethernet cable with a recommended one.	Use the recommended Ethernet cables.
	4) The Ethernet cable connector is disconnected.	Connect the Ethernet cable connector.	<ul style="list-style-type: none"> • Firmly connect the Ethernet cable connector until it clicks into place. • Confirm that the Ethernet cable connector is mated securely.

	5) The Ethernet cable is broken.	Replace the Ethernet cable.	Before you start wiring Ethernet cables, use the cable tester or other devices to confirm that there is no broken cable. Refer to the EtherCAT Network Wiring in <i>NJ/NX-series CPU Unit Built-in EtherCAT Port User's Manual (Cat. No. W505)</i> for precautions on wiring.
	6) The contact of the Ethernet cable connector is faulty, or parts are faulty.	Replace the Ethernet cable.	None
	7) The transmission delay time calculated based on the set value of the total cable length is shorter than the actual transmission delay time.	Set a larger value in Total Cable Length and transfer the setting to the Controller. Or, change the set value in Transmission Delay Time with the measured value, and transfer the setting to the Controller.	Same as the Correction.
	8) An EtherCAT slave manufactured by a company other than OMRON is included in the network configuration, or a non-recommended cable is intentionally used.	For the procedure to update the Transmission Delay Time with the measured value, refer to <i>Setting Transmission Delay Time by Actual Measurement</i> in the <i>NJ/NX-series CPU Unit Built-in EtherCAT Port User's Manual (Cat. No. W505)</i> .	
	9) The network configuration has been changed from the network configuration when the transmission delay time was set, causing increase in transmission delay time.		
	10) The CPU Unit task period is too short.	Connect the Sysmac Studio, increase the task periods of the primary periodic task or priority-5 periodic task, and set and save the network configuration information in the EtherCAT master.	Set the task period of the primary periodic task or priority-5 periodic task to a value that provides sufficient processing time. Use the Simulator to check the necessary EtherCAT communications cycle.
	11) A ring disconnection occurred in the ring topology for which a slave that does not support the ring topology is included.	In a ring topology, use slaves that support the ring topology.	Same as Correction
Attached information	Attached Information 1: Error Details <ul style="list-style-type: none"> • 0001 hex: Occurred in the primary periodic task. • 0002 hex: Occurred in the priority-5 periodic task. 		
Precautions/Remarks	This error will be registered if the frame reception timeout for process data communications occurs consecutively as many times as the set PDO communications timeout detection count.		

Event name	Process Data Communications Error		Event code	842C0000 hex*1	
Meaning	An error occurred in process data communications.				
Source	EtherCAT Master Function Module	Source details	Slave	Detection timing	During communications
Error attributes	Level	Minor fault	Recovery	Error reset	Log category System
Effects	User program	Continues.	Operation	<p>When Fail-soft Operation Is Set to <i>Fail-soft</i> Master: Operation continues. Slave: An error occurred. Operational state continues. If a PDI watchdog error occurs in a slave, the slave enters the Init state.</p> <p>When Fail-soft Operation Is Set to <i>Stop</i> Master: The master changes all slaves to the Pre-Operational state. Slave: An error occurred. When operation stops, the slave changes all slaves to the Pre-Operational state. If a PDI watchdog error occurs in a slave, the slave changes to the Init state.</p>	
Indicators	EtherCAT NET RUN		EtherCAT NET ERR		EtherCAT LINK/ACT
	---		Flashes at 1-s intervals.		---
System-defined variables	Variable	Data type	Name		
	_EC_PDCommErr	BOOL	Process Data Communications Error		
	_EC_CommErrTbl	ARRAY [1..n] OF BOOL *2	Communications Error Slave Table		
	_EC_PDActive	BOOL	Process Data Communications Status		
Cause and correction	Assumed cause	Correction		Prevention	
	<p>A slave left the network even though the disconnection operation or disable operation was not performed.</p> <ul style="list-style-type: none"> The power supply of the slave is turned OFF. The Ethernet cable is removed. 	<ul style="list-style-type: none"> Perform the disconnection operation or disable operation before turning OFF the power supply of the slave. Perform the disconnection operation or disable operation before removing the Ethernet cable. 		Same as the Correction.	
	<p>A slave left the network even though the disconnection operation or disable operation was not performed.</p> <ul style="list-style-type: none"> A connector on the Ethernet cable is disconnected, the contact is faulty, or parts are faulty. The Ethernet cable is broken. The specified cable is not being used. 	<p>The causes given on the left are possible if the error occurs from when the system starts operation or if it always occurs after a specific time after the system starts operation. Use the diagnostic and statistical information from the Sysmac Studio and check the EtherCAT communications status.</p> <p>If the Ethernet cable is broken or if the specified cable was not used, replace the cable. Or, reconnect the connector and make sure it is mated correctly.</p>		<ul style="list-style-type: none"> Confirm that the Ethernet cable connector is mated securely. Make sure that the Ethernet cable is not broken. Make sure that the specified cable is being used. 	
	The slave failed.	If this error occurs again even after the above correction, replace the slave.		None	

Attached information	Attached Information 1: Error Details <ul style="list-style-type: none">• 0001 hex: Slave WDT error (Slave failure)• 0002 hex: Slave disconnected (A slave left the network even though the disconnection operation or disable operation was not performed.)
Precautions/Remarks	None

*1. This event code occurs for project unit version earlier than 1.40.

*2. "n" is 512 for an NX-series CPU Unit and 192 for the NX102, NX1P2, and NJ-series CPU Units.

Event name	Input Process Data Invalid Error		Event code	842F0000 hex*1	
Meaning	Because the EtherCAT master could not perform process data communications normally when it was in the Operational state, the Input Data Invalid state continued for a certain period.				
Source	EtherCAT Master Function Module	Source details	Master	Detection timing	During communications
Error attributes	Level	Minor fault	Recovery	Error reset	Log category System
Effects	User program	Continues.	Operation	<p>When Fail-soft Operation Is Set to <i>Fail-soft</i></p> <p>Master: Operation continues.</p> <p>Slave: Process data communications continue.</p> <p>When Fail-soft Operation Is Set to <i>Stop</i></p> <p>For project unit version earlier than 1.40:</p> <p>Master: The master changes all slaves to the Pre-Operational state.</p> <p>Slave: Process data communications stop. The output is processed according to settings in the slave.</p> <p>For project unit version 1.40 or later:</p> <p>Master: The master changes all slaves to the Safe-Operational state.</p> <p>Slave: Process data communications for output stop. The output is processed according to settings in the slave.</p>	
Indicators	EtherCAT NET RUN	EtherCAT NET ERR		EtherCAT LINK/ACT	
	---	Flashes at 1-s intervals.		---	
System-defined variables	Variable	Data type		Name	
	_EC_IndataInvalidErr	BOOL		Input Process Data Invalid Error	
	_EC_InDataInvalid	BOOL		Input Data Invalid	
	_EC_InData1Invalid	BOOL		Input Data1 Invalid	
	_EC_InData2Invalid	BOOL		Input Data2 Invalid	

Cause and correction	Assumed cause	Correction	Prevention
	One of the following 1) to 5) occurred.		
	1) The Ethernet cable connector is connected uncertainly.	Firmly connect the Ethernet cable connector until it clicks into place.	<ul style="list-style-type: none"> Firmly connect the Ethernet cable connector until it clicks into place. Confirm that the Ethernet cable connector is mated securely.
	2) The Ethernet cable is almost broken.	Replace the Ethernet cable.	Before you start wiring Ethernet cables, use the cable tester or other devices to confirm that there is no broken cable. Refer to EtherCAT Network Wiring in the <i>NJ/NX-series CPU Unit Built-in EtherCAT Port User's Manual (Cat. No. W505)</i> for precautions on wiring.
	3) The contact of the Ethernet cable connector is faulty, or parts are faulty.	Replace the Ethernet cable.	None
	4) Hardware failure of EtherCAT slave	To identify EtherCAT slaves failed, while disconnecting the slaves from the network one by one, correct the error until the <code>_EC_InDataInvalid</code> (Input Data Invalid), <code>_EC_InData1Invalid</code> (Input Data1 Invalid), and <code>_EC_InData2Invalid</code> (Input Data2 Invalid) system-defined variables change to FALSE. When any of these variables change from TRUE to FALSE, the slave disconnected at that time is considered as failed. Replace the slave.	None
	5) Noise	Check the number of error frames in the slave diagnostic and statistical information. It is considered that the slave was affected by noise in each location where an error frame was counted. Implement appropriate noise countermeasures for all locations considered to be affected by noise. Then, make sure that error frames are no longer counted in the slave diagnostic and statistical information.	If error frames are still counted in the master diagnostic and statistical information, remove the noise source or implement noise countermeasures while checking the slave diagnostic and statistical information.
Attached information	Attached information 1: Error Details <ul style="list-style-type: none"> 0001 hex: The error occurred in the primary periodic task. 0002 hex: The error occurred in the priority-5 periodic task. 		
Precautions/Remarks	None		

*1. This event code occurs for unit version 1.13 or later of the CPU Unit.

Event name	Slave State Transition Failed		Event code	84300001 hex*1		
Meaning	Slave state transition failed.					
Source	EtherCAT Master Function Module	Source details	Slave	Detection timing	At power ON, Controller reset, error reset, or during communications	
Error attributes	Level	Minor fault	Recovery	Error reset	Log category	System
Effects	User program	Continues.	Operation	<p>When Fail-soft Operation Is Set to <i>Fail-soft</i></p> <p>Master: Only the slave with the error will stop state transitions. The master changes normal slaves to the Operational state and continues to operate.</p> <p>Slave: This depends on the slave communications status.</p> <p>When Fail-soft Operation Is Set to <i>Stop</i></p> <p>Master:</p> <ul style="list-style-type: none"> • When the master failed to change from the Init state to the Pre-Operational state: The master changes all slaves to the Init state. • When the state transition from the Pre-Operational state to the Safe-Operational state failed: The master changes all slaves to the Pre-Operational state. • When the master failed to change from the Safe-Operational state to the Operational state: The master changes all slaves to the Safe-Operational state. <p>Slave: This depends on the slave communications status.</p>		
Indicators	EtherCAT NET RUN		EtherCAT NET ERR		EtherCAT LINK/ACT	
	---		Flashes at 1-s intervals.		---	
System-defined variables	Variable		Data type		Name	
	_EC_SlavInitErr		BOOL		Slave Initialization Error	
	_EC_CommErrTbl		ARRAY [1..n] OF BOOL *2		Communications Error Slave Table	
Cause and correction	Assumed cause		Correction		Prevention	
	One of the following 1) to 4) occurred. Identify the cause of the error according to the attached information 1 or 4.					

<p>1) An error occurred in a slave during the EtherCAT slave state transition. (When attached information 1 is 0002 hex or 0003 hex)</p>	<p>State transition may have failed due to the following errors. Eliminate the causes of any events that occurred.</p> <ul style="list-style-type: none"> • Illegal Slave Disconnection Detected • Slave PDI WDT Error Detected • Slave AL Status Error Detected • Link OFF Error <p>If a major fault level Controller error occurs, process data communications stop, and this error may occur along with Slave AL Status Error Detected. Perform corrections for the major fault level Controller error.</p> <p>When there are no above current errors, obtain the Sysmac Controller log on the Sysmac Studio and contact your OMRON representative. Refer to <i>Sysmac Studio Version 1 Operation Manual (Cat.No. W504)</i> for how to obtain the Sysmac Controller logs.</p>	<p>Refer to the information on the Illegal Slave Disconnection Detected or Slave PDI WDT Error Detected event, and implement preventive measures.</p> <p>Do not disconnect a slave while the following processing is performed.</p> <ul style="list-style-type: none"> • Error reset • Disconnection command • Reconnection command • Disabling command • Enabling command • Restart • Until the <code>_EC_MBXSlavTbl</code> (Message Communications Enabled Slave Table) system-defined variable changes to TRUE after disconnected or disabled slaves were connected. <p>Perform preventive measures for major fault level Controller errors.</p>
	<p>State transition may have failed due to a slave failure. If the error persists even after you make the above corrections, replace the slave.</p>	<p>None</p>
<p>2) A state transition timeout occurred due to one of the following causes. (When attached information 1 is 0001 hex)</p>		
<p>2-1) A non-recommended cable was used.</p>	<p>Replace the Ethernet cable with a recommended one.</p>	<p>Use the recommended Ethernet cables.</p>
<p>2-2) The Ethernet cable connector is disconnected.</p>	<p>Connect the Ethernet cable connector.</p>	<ul style="list-style-type: none"> • Firmly connect the Ethernet cable connector until it clicks into place. • Confirm that the Ethernet cable connector is mated securely.
<p>2-3) The Ethernet cable is broken.</p>	<p>Replace the Ethernet cable.</p>	<p>Before you start wiring Ethernet cables, use the cable tester or other devices to confirm that there is no broken cable. Refer to the EtherCAT Network Wiring in the <i>NJ/NX-series CPU Unit Built-in EtherCAT Port User's Manual (Cat. No. W505)</i> for precautions on wiring.</p>
<p>2-4) The contact of the Ethernet cable connector is faulty, or parts are faulty.</p>	<p>Replace the Ethernet cable.</p>	<p>None</p>
<p>2-5) A general-purpose Ethernet hub is connected.</p>	<p>Replace it with a specified EtherCAT Junction Slave.</p>	<p>When branching an EtherCAT network, use an EtherCAT Junction Slave.</p>

	2-6) Noise	<p>Implement countermeasures that are appropriate for the source of the noise. Then, make sure that the number of CRC error frames received is no longer counted in the slave diagnostic and statistical information.</p> <p>Refer to the user's manuals for the Units for how to implement noise countermeasures.</p>	<p>Before you start operation, identify the noise source with the slave diagnostic and statistical information. Implement appropriate noise countermeasures.</p>
	2-7) The EtherCAT master or an EtherCAT slave failed.	<p>A state transition timeout may have occurred due to a failure of the CPU unit or slave. If the error persists even after you make the above corrections, replace the CPU unit or slave.</p>	None
	<p>3) A slave returned an error response in the message communications that the EtherCAT master sent during EtherCAT slave state transition.</p> <p>(When attached information 1 is 0004 hex)</p>	<p>Check the abort code in attached information 3. Refer to the operation manual for the slave that returns an error response to check the abort code and make corrections.</p> <p>The following is an example correction for common abort code.</p> <ul style="list-style-type: none"> • Connect the Sysmac Studio, and configure and save the network configuration information in the master again. If this error occurs again, check that there are no errors in the slave synchronization settings and the PDO mapping information, and correct any errors that are found. <p>If the error persists even after you make the corrections for assumed causes 1), 2) and 4), obtain the Sysmac Controller log and contact your OMRON representative. Refer to the <i>Sysmac Studio Version 1 Operation Manual (Cat.No. W504)</i> for how to obtain the Sysmac Controller logs.</p>	<p>Refer to the operation manual for the slave that returns an error response to take preventive measures.</p> <p>If you performed the example correction, set the slave synchronization settings and the PDO mapping information correctly, and configure and save the network configuration information in the master.</p>
	<p>4) When the Module config send method parameter is set to Send for MDP-compatible slave, the transition from Pre-Operational state to Safe-Operational state failed.</p> <p>(When attached information 4 is any of the following:</p> <ul style="list-style-type: none"> • 00010004 hex • 00010008 hex • 00020004 hex • 00020008 hex <p>)</p>	<p>The Module config send method parameter is sometimes displayed for a slave in the EtherCAT network configuration on the Sysmac Studio even if a send method cannot be set. If this occurs, set the Module config send method to Do not send and perform synchronization again.</p> <p>If this error occurs even after the synchronization, check attached information 1 and make corrections.</p>	None

Attached information	<p>Attached information 1: Error Details</p> <ul style="list-style-type: none"> • 0001 hex: State transition timeout • 0002 hex: No reply from the slave • 0003 hex: Slave state transition rejected • 0004 hex: SDO communications response error <p>Attached information 2: Object accessed through SDO communications (Valid only when attached information 1 is 0004 hex.)</p> <ul style="list-style-type: none"> • Upper 16 bits: Index of CoE • Lower 16 bits: Subindex of CoE <p>Attached information 3: Abort code (Valid only when Attached information 1 is 0004 hex)</p> <p>Attached information 4: States before and after transition</p> <ul style="list-style-type: none"> • Upper 16 bits: State before transition • Lower 16 bits: State after transition <p>States displayed in 16 bits</p> <p>0001: Init state 0002: Pre-Operational state 0004: Safe-Operational state 0008: Operational state</p>
Precautions/Remarks	None

*1. This event code occurs for project unit version 1.40 or later.

*2. “n” is 512 for an NX701 CPU Unit, 256 for an NX502 CPU Unit, and 192 for the NX102, NX1P2, and NJ-series CPU Units.

Event name	Illegal Slave Disconnection Detected		Event code	84310002 hex*1	
Meaning	The slave was disconnected incorrectly.				
Source	EtherCAT Master Function Module	Source details	Slave	Detection timing	During communications
Error attributes	Level	Minor fault	Recovery	Error reset	Log category System
Effects	User program	Continues.	Operation	<p>When Fail-soft Operation Is Set to <i>Fail-soft</i></p> <p>Master: Operation continues.</p> <p>Slave: An error occurred in the disconnected slave and all slaves connected to it with a daisy chain. The error is processed according to settings in the slave. For other slaves, process data communications continue.</p> <p>When Fail-soft Operation Is Set to <i>Stop</i></p> <p>Master: The master changes all slaves to the Safe-Operational state.</p> <p>Slave: For all slaves, process data communications for output stop. The output is processed according to settings in the slave. A communication error occurred in the disconnected slave and all slaves with daisy-chain connection after it. The error is processed according to settings in the slave.</p>	
Indicators	EtherCAT NET RUN		EtherCAT NET ERR		EtherCAT LINK/ACT
	---		Flashes at 1-s intervals.		---
System-defined variables	Variable	Data type	Name		
	_EC_PDCommErr	BOOL	Process Data Communications Error		
	_EC_CommErrTbl	ARRAY [1..n] OF BOOL *2	Communications Error Slave Table		
	_EC_PDActive	BOOL	Process Data Communications Status		
Cause and correction	Assumed cause		Correction		Prevention
	<p>One of the following 1) to 7) occurred.</p> <p>Note that these factors do not apply to the following slaves.</p> <ul style="list-style-type: none"> • Disconnected slaves • Disabled slaves 				
	1) The power supply to the slave is turned OFF, or an Ethernet cable is disconnected.		Confirm that all Ethernet cables are connected and connect any cables that are not connected. Or, check whether the power is supplied to the slaves, and cycle the power supply to the slaves.		Before disconnecting a slave from the network by turning OFF the slave's power supply or unplugging the Ethernet cable, first specify that the slave to be disconnected, or both the slave and the slaves connected to it in a daisy chain are to be disabled.
	2) An Ethernet cable connector between slaves is disconnected.		Connect the Ethernet cable connector.		<ul style="list-style-type: none"> • Firmly connect the Ethernet cable connector until it clicks into place. • Confirm that the Ethernet cable connector is mated securely.
	3) A non-recommended cable was used.		Replace the Ethernet cable with a recommended one.		Use the recommended Ethernet cables.

	4) The Ethernet cable is broken.	Replace the Ethernet cable.	Before you start wiring Ethernet cables, use the cable tester or other devices to confirm that there is no broken cable. Refer to the EtherCAT Network Wiring in the <i>NJ/NX-series CPU Unit Built-in EtherCAT Port User's Manual (Cat. No. W505)</i> for precautions on wiring.
	5) The contact of the connector on the Ethernet cable is faulty, or parts are faulty.	Replace the Ethernet cable.	None
	6) The wiring of slaves in the ring topology is incorrect.	Slaves cannot be recognized from a master due to an incorrect wiring in the ring topology. Correct the wiring of the slave shown in the Source details. If the error remains, temporarily remove the cable on the end port of the ring on the actual network configuration, reset the error, and then make the corrections for the event occurred. In addition, you can perform the compare and merge operation in the Sysmac Studio to more efficiently make the corrections.	Confirm that there are no incorrect Ethernet cable connections.
	7) The slave node address was changed during operation.	Make the node address of the actual slave consistent with the node address in the network configuration information. When the physical configuration is correct and the network configuration information is wrong, then correct the node address in the network configuration information.	Do not change the slave node addresses during operation.
Attached information	None		
Precautions/Remarks	<ul style="list-style-type: none"> After you connect the slave where this error occurred to the network, if you reset the error before the value of <code>_EC_EntrySlavTbl[]</code> (Network Connected Slave Table) changes to TRUE of the connected slave, a Network Configuration Verification Error (Slave Unconnected) event occurs. If the assumed cause 1) to 5) occurred in the ring topology when the cable redundancy status was reset temporarily, also this error occurs. 		

*1. This event code occurs for project unit version 1.40 or later.

*2. "n" is 512 for an NX701 CPU Unit, 256 for an NX502 CPU Unit, and 192 for the NX102, NX1P2, and NJ-series CPU Units.

Event name	Network Configuration Verification Error (Unnecessary Slave Connected)		Event code	84320003 hex*1		
Meaning	A slave that is not in the network configuration information is connected.					
Source	EtherCAT Master Function Module		Source details	Master/Slave	Detection timing	At power ON, at Controller reset, or during communications
Error attributes	Level	Minor fault	Recovery	Error reset*2	Log category	System
Effects	User program	Continues.	Operation	<p>When Fail-soft Operation Is Set to <i>Fail-soft</i> At power ON or Controller reset: Master: Operation continues. Slave: For slaves that are consistent with the network configuration information, message communications and process data communications start. For slaves that are not consistent with the network configuration information, message communications and process data communications stop. During communications: Master: Operation continues. Slave: For slaves that are consistent with the network configuration information, message communications and process data communications continue. For slaves that are not consistent with the network configuration information, message communications and process data communications stop.</p> <p>When Fail-soft Operation Is Set to <i>Stop</i> At power ON or Controller reset: Master: The master waits in the Init state. Slave: Message communications and process data communications are not possible. During communications: Master: The master changes all slaves to the Safe-Operational state. Slave: For slaves that are consistent with the network configuration information, process data communications for output stop. The output is processed according to settings in the slave. For slaves that are not consistent with the network configuration information, message communications and process data communications stop.</p>		
Indicators	EtherCAT NET RUN		EtherCAT NET ERR		EtherCAT LINK/ACT	
	---		Flashes at 1-s intervals.		---	

System-defined variables	Variable	Data type	Name
	_EC_NetCfgCmpErr (When attached information 1 is 0001 hex)	BOOL	Network Configuration Verification Error
	_EC_NetTopologyErr (When attached information 1 is 0002 hex)	BOOL	Network Configuration Error
Cause and correction	Assumed cause	Correction	Prevention
	1) A slave that is not in the network configuration information is connected. (When attached information 1 is 0001 hex)	Remove the slave that is not in the network configuration information, with focus on slaves connected to the slave shown in Source details.	Perform the compare and merge operation or use the network configuration information to confirm that the network configuration information on the Sysmac Studio is consistent with the actual network configuration.
	2) The maximum number of connected slaves was exceeded. (When attached information 1 is 0002 hex)	Remove EtherCAT slaves that are not in the network configuration information.	Use the network configuration information to confirm that the network configuration information on the Sysmac Studio is consistent with the actual network configuration.
	3) The wiring of slaves in the ring topology is incorrect.	Check the wiring of the slave shown in the Source details. If the error remains, temporarily remove the cable on the end port of the ring, and then make the corrections for the event occurred. In addition, you can perform the compare and merge operation in the Sysmac Studio to more efficiently make the corrections.	Confirm that there are no incorrect Ethernet cable connections.
Attached information	Attached information 1: Error Details <ul style="list-style-type: none"> • 0001 hex: A slave that is not in the network configuration information is connected. • 0002 hex: The maximum number of connected slaves was exceeded. Attached information 2: Port name of the port to which the slave that is not in the network configuration information is connected (When attached information 1 is 0001 hex) Attached information 3: System information		
Precautions/Remarks	None		

*1. This event code occurs for project unit version 1.40 or later.

*2. It may be necessary to cycle the power supply.

Event name	Network Configuration Verification Error (Mismatched Slave)		Event code	84330004 hex*1		
Meaning	Slaves in the network configuration information and in the actual network configuration do not match.					
Source	EtherCAT Master Function Module		Source details	Slave	Detection timing	At power ON, at Controller reset, or during communications
Error attributes	Level	Minor fault	Recovery	Error reset	Log category	System
Effects	User program	Continues.	Operation	<p>When Fail-soft Operation Is Set to <i>Fail-soft</i> At power ON or Controller reset: Master: Operation starts. Slave: For slaves that are consistent with the network configuration information, message communications and process data communications start. For slaves that are not consistent with the network configuration information, message communications and process data communications stop. During communications: Master: Operation continues. Slave: For slaves that are consistent with the network configuration information, message communications and process data communications continue. For slaves that are not consistent with the network configuration information, message communications and process data communications stop.</p> <p>When Fail-soft Operation Is Set to <i>Stop</i> At power ON or Controller reset: Master: The master waits in the Init state. Slave: Message communications and process data communications stop. During communications: Master: The master changes all slaves to the Safe-Operational state. Slave: For slaves that are consistent with the network configuration information, process data communications for output stop. The output is processed according to settings in the slave. For slaves that are not consistent with the network configuration information, message communications and process data communications stop.</p>		
Indicators	EtherCAT NET RUN		EtherCAT NET ERR		EtherCAT LINK/ACT	
	---		Flashes at 1-s intervals.		---	
System-defined variables	Variable		Data type		Name	
	_EC_NetCfgCmpErr		BOOL		Network Configuration Verification Error	
	_EC_CommErrTbl		ARRAY [1..n] OF BOOL *2		Communications Error Slave Table	

Cause and correction	Assumed cause	Correction	Prevention
	1) There is a node address mismatch. (When the attached information 1 is 0004 hex)	Change the node address of the EtherCAT slave so that it is consistent with the network configuration information.	Perform the compare and merge operation or use the network configuration information to confirm that the network configuration information on the Sysmac Studio is consistent with the actual network configuration.
	2) A slave that is different from the network configuration information is connected. (When the attached information 1 is not 0004 hex)	Check any mismatched items and change them so that the network configuration information is consistent with the physical slaves. When verification of the revision or serial number is not necessary or consistency is not required, review the values of Revision Check Method and Serial Number Check Method.	Perform the compare and merge operation or use the network configuration information to confirm that the network configuration information on the Sysmac Studio is consistent with the actual network configuration.
	3) The wiring of slaves in the ring topology is incorrect.	Check the wiring of the slave shown in the Source details. If the error remains, temporarily remove the cable on the end port of the ring, and then make the corrections for the event occurred. In addition, you can perform the compare and merge operation in the Sysmac Studio to more efficiently make the corrections.	Confirm that there are no incorrect Ethernet cable connections.
Attached information	Attached information 1: Item that is verified the mismatch. 0000 hex: Vendor ID 0001 hex: Product code 0002 hex: Revision 0003 hex: Serial number 0004 hex: Slave node address		
Precautions/Remarks	None		

*1. This event code occurs for project unit version 1.40 or later.

*2. "n" is 512 for an NX701 CPU Unit, 256 for an NX502 CPU Unit, and 192 for the NX102, NX1P2, and NJ-series CPU Units.

Event name	Slave PDI WDT Error Detected		Event code	84340000 hex*1		
Meaning	A slave PDI WDT error was detected.					
Source	EtherCAT Master Function Module		Source details	Slave	Detection timing	At power ON, at Controller reset, or during communications
Error attributes	Level	Minor fault	Recovery	Error reset	Log category	System
Effects	User program	Continues.	Operation	<p>When Fail-soft Operation Is Set to <i>Fail-soft</i> Master: Operation continues. Slave: For slaves with a PDI WDT error, message communications and process data communications stop.</p> <p>When Fail-soft Operation Is Set to <i>Stop</i> Master: The master changes all slaves to the Safe-Operational state. Slave: For slaves with a PDI WDT error, message communications and process data communications stop. For slaves without a PDI WDT error, process data communications for output stop. The output is processed according to settings in the slave.</p>		
Indicators	EtherCAT NET RUN		EtherCAT NET ERR		EtherCAT LINK/ACT	
	---		Flashes at 1-s intervals.		---	
System-defined variables	Variable	Data type		Name		
	_EC_PDCommErr	BOOL		Process Data Communications Error		
	_EC_CommErrTbl	ARRAY [1..n] OF BOOL *2		Communications Error Slave Table		
	_EC_PDActive	BOOL		Process Data Communications Status		
Cause and correction	Assumed cause		Correction		Prevention	
	One of the following 1) to 3) occurred.					
	1) EtherCAT slave power supply voltage dropped		Check if the power supply voltage of the slave device has not dropped.		Take appropriate measures to ensure that the specified power with the rated voltage and frequency is supplied in places where the power supply is unstable.	
	2) EtherCAT slave failure		Cycle the power supply to the slave. If this error persists, replace the slave.		None	
	3) No reply from the slave (For slaves that are manufactured by other companies only)		Cycle the power supply to the slave. If this error persists, contact the manufacturer of the slave.		None	
Attached information	None					
Precautions/Remarks	None					

*1. This event code occurs for project unit version 1.40 or later.

*2. "n" is 512 for an NX701 CPU Unit, 256 for an NX502 CPU Unit, and 192 for the NX102, NX1P2, and NJ-series CPU Units.

Event name	Slave AL Status Error Detected		Event code	84360000 hex ^{*1}	
Meaning	An AL status error was detected from an EtherCAT slave.				
Source	EtherCAT Master Function Module		Source details	Slave	Detection timing
					At power ON, at Controller reset, or during communications
Error attributes	Level	Minor fault	Recovery	Error reset	Log category
					System
Effects	User program	Continues.	Operation	<p>When Fail-soft Operation Is Set to <i>Fail-soft</i></p> <p>Master: Operation continues.</p> <p>Slave: For slaves with an application layer status error, status transition occurs depending on the application layer status.</p> <p>When Fail-soft Operation Is Set to <i>Stop</i></p> <p>Master: The master changes all slaves to the Safe-Operational state.</p> <p>Slave: For slaves with an application layer status error, status transition occurs depending on the application layer status.</p> <p>For slaves without an application layer status error, process data communications for output stop. The output is processed according to settings in the slave.</p>	
Indicators	EtherCAT NET RUN		EtherCAT NET ERR		EtherCAT LINK/ACT
	---		Flashes at 1-s intervals.		---
System-defined variables	Variable	Data type		Name	
	_EC_SlavAppErr	BOOL		Slave Application Error	
	_EC_CommErrTbl	ARRAY [1..n] OF BOOL ^{*2}		Communications Error Slave Table	
Cause and correction	Assumed cause	Correction		Prevention	
	An error occurred on the EtherCAT slave side and the AL status code was reported by the EtherCAT slaves to the EtherCAT master.	Refer to the attached information 1 to check the AL status code of the slave where the error occurred. Refer to the manual for the slave to remove the cause of the error of the code and then reset the error.		Refer to the manual for the slave to take preventive measures.	
Attached information	Attached Information 1: AL status code Attached information 2: System information Attached information 3: System information Attached information 4: System information				
Precautions/Remarks	None				

*1. This event code occurs for project unit version 1.40 or later.

*2. "n" is 512 for an NX701 CPU Unit, 256 for an NX502 CPU Unit, and 192 for the NX102, NX1P2, and NJ-series CPU Units.

Event name	Clock Synchronization Compensation Failed		Event code	84370000 hex*1	
Meaning	Clock synchronization with slaves failed.				
Source	EtherCAT Master Function Module	Source details	Master	Detection timing	At power ON, at Controller reset, or during communications
Error attributes	Level	Minor fault	Recovery	Error reset	Log category System
Effects	User program	Continues.	Operation	<p>When Fail-soft Operation Is Set to <i>Fail-soft</i></p> <p>Master: Operation continues.</p> <p>Slave: An error may occur in slaves. The error is processed according to settings in the slave.</p> <p>When Fail-soft Operation Is Set to <i>Stop</i></p> <p>Master: The master changes all slaves to the Safe-Operational state.</p> <p>Slave: Process data communications for output stop. The output is processed according to settings in the slave.</p>	
Indicators	EtherCAT NET RUN		EtherCAT NET ERR		EtherCAT LINK/ACT
	---		Flashes at 1-s intervals.		---
System-defined variables	Variable		Data type		Name
	None		---		---
Cause and correction	Assumed cause		Correction		Prevention
	The network configuration was changed during state transition.		Implement countermeasures against the Illegal Slave Disconnection Detected event.		None
	EtherCAT slave failure		Cycle the power supply to the slave. If this error persists, replace the slave.		None
	Noise		Check the number of error frames in the slave diagnostic and statistical information. It is considered that the slave was affected by noise in each location where an error frame was counted. Implement appropriate noise countermeasures for all locations considered to be affected by noise. Then, make sure that error frames are no longer counted in the slave diagnostic and statistical information.		If error frames are still counted in the master diagnostic and statistical information, remove the noise source or implement noise countermeasures while checking the slave diagnostic and statistical information.
Attached information	None				
Precautions/Remarks	None				

*1. This event code occurs for project unit version 1.40 or later.

Event name	Network Configuration Verification Error (Slave Unconnected)		Event code	84380000 hex ^{*1}		
Meaning	A slave that is in the network configuration information is not connected.					
Source	EtherCAT Master Function Module		Source details	Slave	Detection timing	At power ON, at Controller reset, or during communications
Error attributes	Level	Minor fault	Recovery	Error reset	Log category	System
Effects	User program	Continues.	Operation	<p>When Fail-soft Operation Is Set to <i>Fail-soft</i> At power ON or Controller reset: Master: Operation starts. Slave: For slaves that are consistent with the network configuration information, message communications and process data communications start. For slaves that are not consistent with the network configuration information, message communications and process data communications stop. During communications: Master: Operation continues. Slave: For slaves that are consistent with the network configuration information, message communications and process data communications continue. For slaves that are not consistent with the network configuration information, message communications and process data communications stop.</p> <p>When Fail-soft Operation Is Set to <i>Stop</i> At power ON or Controller reset: Master: The master waits in the Init state. Slave: Message communications and process data communications are not possible. During communications: Master: The master changes all slaves to the Safe-Operational state. Slave: For slaves that are consistent with the network configuration information, process data communications for output stop. The output is processed according to settings in the slave. For slaves that are not consistent with the network configuration information, message communications and process data communications stop.</p>		
Indicators	EtherCAT NET RUN		EtherCAT NET ERR		EtherCAT LINK/ACT	
	---		Flashes at 1-s intervals.		---	
System-defined variables	Variable		Data type		Name	
	_EC_NetCfgCmpErr		BOOL		Network Configuration Verification Error	
	_EC_CommErrTbl		ARRAY [1..n] OF BOOL ^{*2}		Communications Error Slave Table	
Cause and correction	Assumed cause		Correction		Prevention	

	1) The power supply to the slave is not turned ON.	Turn ON the power supply to the slave.	Confirm that the power supply to the slave is turned ON.
	2) The Ethernet cable connector is disconnected between the slaves.	Connect the Ethernet cable connector.	<ul style="list-style-type: none"> Firmly connect the Ethernet cable connector until it clicks into place. Confirm that the Ethernet cable connector is mated securely.
	3) The wait time for slave startup was exceeded because the link establishment was too slow or the power supply startup of the slaves was too long.	Set the wait time for slave startup sufficiently long.	Same as the Correction.
	4) A non-recommended Ethernet cable is used to connect slaves.	Replace the Ethernet cable with a recommended one.	Use the recommended Ethernet cables.
	5) The Ethernet cable is broken between slaves.	Replace the Ethernet cable.	Before you start wiring Ethernet cables, use the cable tester or other devices to confirm that there is no broken cable. Refer to the EtherCAT Network Wiring in the <i>NJ/NX-series CPU Unit Built-in EtherCAT Port User's Manual (Cat. No. W505)</i> for precautions on wiring.
	6) The contact of the connector on the Ethernet cable that connects slaves is faulty, or parts are faulty.	Replace the Ethernet cable.	None
	7) The wiring of slaves in the ring topology is incorrect.	<p>Slaves cannot be recognized from a master due to an incorrect wiring in the ring topology. Correct the wiring of the slave shown in the Source details.</p> <p>If the error remains, temporarily remove the cable on the end port of the ring on the actual network configuration, reset the error, and then make the corrections for the event occurred.</p> <p>In addition, you can perform the compare and merge operation in the Sysmac Studio to more efficiently make the corrections.</p>	Confirm that there are no incorrect Ethernet cable connections.
	8) Hardware failure of a slave	If this error persists even after you cycle the power supply to the relevant slave, replace the slave.	None
Attached information	None		
Precautions/Remarks	After you connect the slave where this error occurred to the network, if you reset the error before the value of <code>_EC_EntrySlavTbl[]</code> (Network Connected Slave Table) changes to TRUE of the connected slave, a Network Configuration Verification Error (Slave Unconnected) event occurs.		

*1. This event code occurs for project unit version 1.40 or later.

*2. "n" is 512 for an NX701 CPU Unit, 256 for an NX502 CPU Unit, and 192 for the NX102, NX1P2, and NJ-series CPU Units.

Event name	Network Configuration Verification Error (Incorrect Ring Wiring)		Event code	843A0000 hex*1		
Meaning	The ring topology that is not set in the network configuration information, is configured on the actual network.					
Source	EtherCAT Master Function Module		Source details	Master	Detection timing	At power ON, at Controller reset, or during communications
Error attributes	Level	Minor fault	Recovery	Error reset	Log category	System
Effects	User program	Continues.	Operation	<p>When Fail-soft Operation Is Set to <i>Fail-soft</i> At power ON or Controller reset: Master: Operation starts. Slave: For slaves that are consistent with the network configuration information, message communications and process data communications start. For slaves that are not consistent with the network configuration information, message communications and process data communications stop. During communications: Master: Operation continues. Slave: For slaves that are consistent with the network configuration information, message communications and process data communications continue. For slaves that are not consistent with the network configuration information, message communications and process data communications stop.</p> <p>When Fail-soft Operation Is Set to <i>Stop</i> At power ON or Controller reset: Master: The master waits in the Init state. Slave: Message communications and process data communications stop. During communications: Master: The master changes all slaves to the Safe-Operational state. Slave: Process data communications stop. For slaves that are consistent with the network configuration information, process data communications for output stop. The output is processed according to settings in the slave. For slaves that are not consistent with the network configuration information, message communications and process data communications stop.</p>		
Indicators	EtherCAT NET RUN		EtherCAT NET ERR		EtherCAT LINK/ACT	
	---		Flashes at 1-s intervals.		---	
System-defined variables	Variable	Data type		Name		
	None	---		---		

Cause and correction	Assumed cause	Correction	Prevention
	One of the following 1) to 2) occurred.	<p>Make corrections as described below:</p> <p>For how to correct errors for events related to the ring topology, refer to <i>A-8 Correction of Wiring for the EtherCAT Ring Topology Based on Event</i> on page A-306 in the appendices of the <i>NJ/NX-series Troubleshooting Manual (Cat. No. W503)</i>.</p> <p>Temporarily remove the cable on the end port of the ring to efficiently make the corrections for the event occurred. You can also perform the compare and merge operation in the Sysmac Studio to more efficiently make the corrections.</p>	
	1) The ring topology configured on the actual network is not defined in the network configuration information. (When attached information 1 is 0)	In the network configuration information, define the ring topology in the position where the ring topology in the actual network configuration is located.	Perform the compare and merge operation or use the network configuration information to confirm that the network configuration information on the Sysmac Studio is consistent with the actual network configuration.
	2) The ring topology is configured in a different position from one that is defined in the network configuration information. (When attached information 1 is not 0)	Cancel the ring topology on the actual network and configure a ring topology in the position where it is defined in the network configuration information.	Same as the above
Attached information	<p>Attached information 1: Error Location</p> <ul style="list-style-type: none"> • 0: No ring topology is defined in the network configuration information • Not 0: Node address of the originating slave of the ring in the network configuration information <p>Attached information 2: Names of the start port and end port of the ring in the network configuration information (When attached information 1 is not 0)</p>		
Precautions/Remarks	None		

*1. This event code occurs for project unit version 1.40 or later.

Event name	Incorrect Wiring Detected		Event code	843C0000 hex*1	
Meaning	The wiring of an EtherCAT network is incorrect.				
Source	EtherCAT Master Function Module	Source details	Master	Detection timing	At power ON, at Controller reset, or during communications
Error attributes	Level	Minor fault	Recovery	Error reset*2	Log category System
Effects	User program	Continues.	Operation	<p>When Fail-soft Operation Is Set to <i>Fail-soft</i> At power ON or Controller reset: Master: The master waits in the Init state. Slave: Message communications and process data communications stop. During communications: Master: Operation continues. Slave: Message communications and process data communications may stop.</p> <p>When Fail-soft Operation Is Set to <i>Stop</i> At power ON or Controller reset: Master: The master waits in the Init state. Slave: Message communications and process data communications stop. During communications: Master: The master changes all slaves to the Safe-Operational state. Slave: Process data communications for output stop. The output is processed according to settings in the slave. Message communications and process data communications for input may not be possible.</p>	
Indicators	EtherCAT NET RUN	EtherCAT NET ERR		EtherCAT LINK/ACT	
	---	Flashes at 1-s intervals.		---	
System-defined variables	Variable	Data type		Name	
	_EC_NetTopologyErr	BOOL		Network Configuration Error	

Cause and correction	Assumed cause	Correction	Prevention
	1) Input ports or output ports are connected to each other.	Confirm that input ports and output ports are not connected to each other.	Confirm that there are no incorrect Ethernet cable connections.
	2) Two or more ring topologies are configured.	Confirm that the wiring of the ring topology is not connected other than the attached information 1 and 2.	
	3) The start port of the ring and the end port of the ring are not combined correctly.	Confirm that the wiring of the ring topology is connected according to the attached information 1 and 2.	
	4) The wiring for the start port of the ring and one for the end port of the ring are reversed.	Confirm that the wiring of the ring topology is connected according to the attached information 1 and 2.	
	5) The wiring of a Junction Slave in the ring topology is incorrect.	For a Junction Slave in the ring topology, confirm that the input port and the last port are used for the wiring which is the trunk line in the ring topology.	
	6) A ring topology that is not in the network configuration information is on the actual network.	Correct the actual network configuration to agree with the network configuration information.	
Attached information	<p>Attached information 1: Node address of the originating slave of the ring in the network configuration information. It is 0 when the cable redundancy is not set in network configuration information.</p> <p>Attached information 2: Names of the start port and end port of the ring in the network configuration information. (When the cable redundancy is set in the network configuration information.)</p> <p>Attached information 3: Depends on the project unit version</p> <ul style="list-style-type: none"> For project unit version earlier than 1.42: System information For project unit version 1.42 or later: <ul style="list-style-type: none"> Node address of the slave whose wiring is not correct ^{Note 1} It is 0 when the slave whose wiring is not correct cannot be identified. <p>Note 1. If there is a ring topology in the actual network configuration, the node address of the slave whose wiring is not correct may not be displayed correctly. If the error location cannot be identified by the attached information 3 or the wiring for the slave shown in the attached Information 3 is correct, check that there is no error for each slave and cable. If you cannot identify the error location yet, temporarily remove the cable on the end port of the ring, and then make the corrections for the event occurred.</p>		
Precautions/Remarks	None		

*1. This event code occurs for project unit version 1.40 or later.

*2. It may be necessary to cycle the power supply.

Event name	Wait for Cycling Power Supply			Event code	94520000 hex ^{*1}
Meaning	It is necessary to cycle the power supply to the Controller or reset the Controller for the recovery from an error.				
Source	EtherCAT Master Function Module		Source details	Master	Detection timing *2
Error attributes	Level	Minor fault	Recovery	Cycle the power supply or reset the Controller.	Log category System
Effects	User program	Continues.	Operation	*2	
Indicators	EtherCAT NET RUN		EtherCAT NET ERR		EtherCAT LINK/ACT
	---		Flashes at 1-s intervals.		---
System-defined variable	Variable		Data type		Name
	None		---		---
Cause and correction	Assumed cause		Correction		Prevention
	An event, which is necessary to cycle the power supply or reset the Controller for the recovery, occurred.		Make the corrections for the event caused by this event and then cycle the power supply or reset the Controller. The current errors in the EtherCAT Master Function Module cannot be reset during the occurrence of this event.		Implement preventive measures for the event caused by this event.
Attached information	Attached information 1: Event code of the event caused by this event				
Precautions/Remarks	None				

*1. This event code occurs for project unit version 1.40 or later.

*2. According to the event caused by this event.

Event name	EtherCAT Slave Backup Failed (Ver. 1.03 or later and project unit version earlier than 1.40)*1		Event code	102F0000 hex*1		
Meaning	The backup operation for an EtherCAT slave ended in an error.					
Source	EtherCAT Master Function Module	Source details	Master	Detection timing	During backup operation	
Error attributes	Level	Observation	Recovery	---	Log category	System
Effects	User program	Continues.	Operation	Not affected.		
Indicators	EtherCAT NET RUN		EtherCAT NET ERR		EtherCAT LINK/ACT	
	---		---		---	
System-defined variables	Variable		Data type		Name	
	None		---		---	
Cause and correction	Assumed cause		Correction		Prevention	
	There is no connection between the EtherCAT master and the slave (Link OFF).		Wire the EtherCAT master and slave securely.		Wire the EtherCAT master and slave securely and make sure that a connection is established before you attempt to back up the data.	
	An error caused an incorrect EtherCAT master status.		Use the Sysmac Studio or the Troubleshooter of an HMI to check for errors and eliminate any EtherCAT errors.		Back up the data when there are no EtherCAT errors.	
	The EtherCAT network configuration information does not agree with the physical network configuration.		Make sure that network configuration information agrees with the physical network configuration.		Back up the data only when the network configuration information agrees with the physical network configuration.	
	The request to the EtherCAT slave failed.		Connect the cable securely. Implement noise countermeasures if there is excessive ambient noise. If the situation does not improve, replace the EtherCAT slave.		Connect the cable securely. Implement noise countermeasures if there is excessive ambient noise.	
	The EtherCAT master was temporarily unable to perform the processing because it was executing other processing.		Try backing up the data again.		None	
	Initialization of the EtherCAT slave failed.		Connect any slaves that are disconnected. Use the Sysmac Studio or the Troubleshooter of an HMI to check for the following errors: Slave Initialization Error, Slave Application Error, and Process Data Communications Error. Eliminate any errors that you find.		Back up the data when the EtherCAT slave is participating in the network and there are no slaves that are disconnected from the network. Also, back up the data when there is no Process Data Communications Error.	
	It was not possible to read the backup parameters from the EtherCAT slave.		The ESI file may be incorrect. Ask the manufacturer of the slave if you can read all of the parameters that are set as backup parameters. If all of the backup parameters can be read, the EtherCAT slave is faulty. Replace the EtherCAT slave.		None	

	Communications with an OMRON Communications Coupler Unit or NX Unit failed.	Connect the cable securely. Mount the NX Unit securely. Implement noise countermeasures if there is excessive ambient noise. If the problem still exists, replace the Communications Coupler Unit or the NX Unit.	Connect the cable securely. Mount the NX Unit securely. Implement noise countermeasures if there is excessive ambient noise.
Attached information	<p>Attached Information 1: Error Details (The following values are in the order of the causes of the error.)</p> <ul style="list-style-type: none"> • 0001 hex: Link OFF • 0002 hex: Incorrect master status • 0003 hex: Configuration information does not agree with network configuration. • 0004 hex: The request to the EtherCAT slave failed. • 0005 hex: Master status temporarily prevented processing. • 0006 hex: An error occurred in slave initialization or a slave is disconnected from the network. • 0007 hex: Reading the backup data failed. • 000B hex: Error at OMRON Communications Coupler Unit <p>Attached Information 2: Error Location</p> <ul style="list-style-type: none"> • 0: Master • 1 or higher: Slave node address <p>Attached Information 3: Error Location Details (only when attached information 1 is 000B hex).</p> <ul style="list-style-type: none"> • 0: Communications Coupler Unit • 1 to 63: Unit number of NX Unit <p>Attached Information 4: Cause of Error at OMRON Communications Coupler Unit (only when attached information 1 is 000B hex).</p> <ul style="list-style-type: none"> • 2: Communications with the Communications Coupler Unit or NX Unit failed. 		
Precautions/Remarks	None		

- *1. This event code occurs for a CPU Unit with unit version 1.03 or later and project unit version earlier than 1.40. For project unit version 1.40 or later, refer to the description of the event code 10460001 hex.
- *2. "n" is 512 for an NX701 CPU Unit, 256 for an NX502 CPU Unit, and 192 for the NX102, NX1P2, and NJ-series CPU Units.

Event name	EtherCAT Slave Restore Operation Failed (Ver. 1.03 or later and project unit version earlier than 1.40)*1		Event code	10300000 hex*1		
Meaning	The restore operation for an EtherCAT slave ended in an error.					
Source	EtherCAT Master Function Module	Source details	Master	Detection timing	During restore operation	
Error attributes	Level	Observation	Recovery	---	Log category	System
Effects	User program	Continues.	Operation	Not affected.		
Indicators	EtherCAT NET RUN		EtherCAT NET ERR		EtherCAT LINK/ACT	
	---		---		---	
System-defined variables	Variable		Data type		Name	
	None		---		---	
Cause and correction	Assumed cause		Correction		Prevention	
	There is no connection between the EtherCAT master and the slave (Link OFF).		Wire the EtherCAT master and slave securely.		Wire the EtherCAT master and slave securely, and make sure that a connection is established before you attempt to restore the data.	
	Wire the EtherCAT master and slave securely, and make sure that a connection is established before you attempt to restore the data.		Use the Sysmac Studio or the Troubleshooter of an HMI to check for errors and eliminate any EtherCAT errors.		Restore the data when there are no EtherCAT errors.	
	The EtherCAT network configuration information does not agree with the physical network configuration.		Make sure that network configuration information agrees with the physical network configuration. Always use a slave revision that is the same or higher than the slave revision that was used when the data was backed up even if you set <i>No check</i> for the Revision Check Method for backup. Set <i>No check</i> for the Serial Number Check Method and then back up the data. If you replace a slave with the Serial Number Check Method set to <i>Setting = Actual device</i> , do not use the restore function. Instead, change the network configuration from the Sysmac Studio, download the network configuration, and then transfer the slave parameters. If the node address is set on the hardware switches, use the same setting as when the data was backed up.		Restore the data only when the network configuration information agrees with the physical network configuration.	

<p>The request to the EtherCAT slave failed. (When attached information 1 is 0004 hex)</p>	<p>Connect the cable securely. Implement noise countermeasures if there is excessive ambient noise. If the situation does not improve, execute the restore operation with restore function on the Sysmac Studio except for the EtherCAT slave. In this case, backup parameters are not restored to the EtherCAT slave. After the execution of the restore operation, transfer parameters to the EtherCAT slave with synchronization function on the Sysmac Studio. If the situation does not improve yet, replace the EtherCAT slave.</p>	<p>Connect the cable securely. Implement noise countermeasures if there is excessive ambient noise.</p>
<p>The EtherCAT master was temporarily unable to perform the processing because it was executing other processing.</p>	<p>Try restoring the data again.</p>	<p>None</p>
<p>Initialization of the EtherCAT slave failed.</p>	<p>Use the Sysmac Studio or the Troubleshooter of an HMI to check for the following errors: Slave Initialization Error, Slave Application Error, and Process Data Communications Error. Eliminate any errors that you find.</p>	<p>Restore the data when there is no Process Data Communications Error.</p>
<p>It was not possible to write the backup parameters to the MX2/RX Series Inverter. (This applies only for unit version 1.10 or earlier of the CPU Unit.)</p>	<p>Download the parameters to the Inverter using the "To Drive" menu of the Sysmac Studio.</p>	<p>Data is sometimes not restored due to Inverter restrictions. If that occurs, download the parameters to the Inverter using the "To Drive" menu of the Sysmac Studio.</p>
<p>It was not possible to write the backup parameters to the EtherCAT slave.</p>	<p>The ESI file may be incorrect. Ask the manufacturer of the slave if you can write all of the parameters that are set as backup parameters. If all of the backup parameters can be written, the slave is faulty. Replace the slave.</p>	<p>None</p>
<p>Incorrect backup data was detected.</p>	<p>Format the SD Memory Card with the Sysmac Studio and then place the backup files on it.</p>	<p>Do not remove the SD Memory Card or turn OFF the power supply while the SD BUSY indicator is lit. Or, replace the SD Memory Card periodically according to the write life of the SD Memory Card.</p>
<p>The EtherCAT network configuration in the backup data does not agree with the physical network configuration.</p>	<p>Make sure that the EtherCAT network configuration in the backup data agrees with the physical network configuration.</p>	<p>Make sure that the EtherCAT network configuration in the backup data agrees with the physical network configuration before you try to restore the data.</p>

	<p>An error occurred at an OMRON Communications Coupler Unit. The following causes are possible.</p> <ul style="list-style-type: none"> • Reading a backup file failed at the Communications Coupler Unit (when attached information 4 is 1). • Communications with the Communications Coupler Unit or NX Unit failed (when attached information 4 is 2). • The Unit Configuration of the NX Units in the Communications Coupler Unit when data was backed up did not agree with the actual configuration of NX Units (when attached information 4 is 3). 	<ul style="list-style-type: none"> • Try backing up the data again (when attached information 4 is 1). • Connect the cable securely. Mount the NX Unit securely. Implement noise countermeasures if there is excessive ambient noise. If the problem still exists, replace the Communications Coupler Unit or the NX Unit (when attached information 4 is 2). • Make the Unit Configuration of the NX Units in the Communications Coupler Unit when data was backed up agree with the actual configuration of NX Units (when attached information 4 is 2 or 3). • Correct the hardware switches on the Communications Coupler Unit so that they are the same as when the data was backed up (when attached information 4 is 3). 	<ul style="list-style-type: none"> • Format an SD Memory Card with the Sysmac Studio and then place the backup file on it. Also, do not remove the SD Memory Card or turn OFF the power supply while the SD BUSY indicator is lit (when attached information 4 is 1). • Connect the cable securely. Mount the NX Unit securely. Implement noise countermeasures if there is excessive ambient noise (when attached information 4 is 2). • Restore the data while the Unit Configuration of the NX Units in the Communications Coupler Unit agrees with the actual configuration of NX Units (when attached information 4 is 2 or 3). • Restore the data while the hardware switches on the Communications Coupler Unit are the same as when the data was backed up (when attached information 4 is 3).
<p>Attached information</p>	<p>Attached Information 1: Error Details (The following values are in the order of the causes of the error.)</p> <ul style="list-style-type: none"> • 0001 hex: Link OFF • 0002 hex: Incorrect master status • 0003 hex: Configuration information does not agree with network configuration. • 0004 hex: The request to the EtherCAT slave failed. • 0005 hex: Master status temporarily prevented processing. • 0006 hex: An error occurred in slave initialization. • 0007 hex: Writing the backup data failed. • 0008 hex: The backup data is not correct. • 0009 hex: The network configuration does not agree with the network configuration in the backup data. • 000A hex: The service is not supported • 000B hex: Error at OMRON Communications Coupler Unit <p>Attached Information 2: Error Location</p> <ul style="list-style-type: none"> • 0: Master • 1 or higher: Slave node address <p>Attached Information 3: Error Location Details (only when attached information 1 is 000B hex).</p> <ul style="list-style-type: none"> • 0: Communications Coupler Unit • 1 to 63: Unit number of NX Unit <p>Attached Information 4: Cause of Error at OMRON Communications Coupler Unit (only when attached information 1 is 000B hex).</p> <ul style="list-style-type: none"> • 1: Reading the backup file failed. • 2: Communications with the Communications Coupler Unit or NX Unit failed. • 3: The Unit Configuration does not agree with the Unit Configuration in the backup data. 		
<p>Precautions/Remarks</p>	<p>None</p>		

*1. This event code occurs for a CPU Unit with unit version 1.03 or later and project unit version earlier than 1.40. For project unit version 1.40 or later, refer to the description of the event code 10460001 hex.

Event name	EtherCAT Slave Backup Failed (Project unit version 1.40 or later)* ¹		Event code	10460001 hex* ¹	
Meaning	The backup operation for an EtherCAT slave ended in an error.				
Source	EtherCAT Master Function Module		Source details	Master	Detection timing During backup operation
Error attributes	Level	Observation	Recovery	---	Log category System
Effects	User program	Continues.	Operation	Not affected.	
Indicators	EtherCAT NET RUN		EtherCAT NET ERR		EtherCAT LINK/ACT
	---		---		---
System-defined variables	Variable		Data type		Name
	None		---		---
Cause and correction	Assumed cause		Correction		Prevention
	One of the following 1) to 5) occurred. Identify the cause of the error according to the attached information 1.				
	1) The EtherCAT master cannot start backup. (When the attached information 1 is 0002 hex)		Due to an event that occurred in the communications port or master, you cannot perform backup operation. Identify the error cause and make the correction according to the information on the event that occurred in the communications port or master shown in Source details.		Refer to the information on the event that occurred, and implement preventive measures for the error cause.
	2) It was not possible to read the backup parameters to the EtherCAT slave. (When the attached information 1 is 0007 hex)		Ask the manufacturer of the slave if you can read all of the parameters that are set as backup parameters in the order displayed on the Backup Parameter Edit Pane for the slave. On the Backup Parameter Edit Pane, reorder the parameters that must be read in a specific order and delete any parameters that cannot be read.		Same as the Correction.

	<p>3) The request to the EtherCAT slave failed. (When the attached information 1 is 0004 hex)</p> <p>4) Communications with an OMRON Communications Coupler Unit or NX Unit failed. (When the attached information 1 is 000B hex)</p>	<p>a. Reading the backup parameters failed due to an event that occurred in the master, slave, OMRON Communications Coupler Unit, or NX Unit. Identify the error cause and make the correction according to the information on the event that occurred.</p> <p>b. There is a possibility that reading the backup parameters failed due to a contact failure of the connector, connection failure of the cable, or noise. Check the number of error frames in the slave diagnostic and statistical information. If the error frame is counted, the contact failure of the connector, connection failure of the cable, or noise may be occurred in the location where an error frame was counted. Implement countermeasures such as reconnect the connector or cable, or remove the noise source while checking the slave diagnostic and statistical information.</p>	<p>a. Refer to the information on the event occurred, and implement preventive measures.</p> <p>b. Make sure that error frames are no longer counted in the slave diagnostic and statistical information. If the error frame is counted, implement countermeasures such as reconnecting the connector or cable or removing the noise source while checking the slave diagnostic and statistical information.</p>
	<p>5) Backup was executed for a disconnected slave. (When the attached information 1 is 0006 hex)</p>	<p>Connect any slaves that are disconnected.</p>	<p>Back up the data when there are no disconnected slaves.</p>
Attached information	<p>Attached Information 1: Error Details</p> <ul style="list-style-type: none"> • 0002 hex: Incorrect master status • 0004 hex: The request to the EtherCAT slave failed. • 0006 hex: A slave is disconnected from the network. • 0007 hex: Reading the backup data failed. • 000B hex: Error at OMRON Communications Coupler Unit <p>Attached Information 2: Error Location</p> <ul style="list-style-type: none"> • 0: Master • Not 0: Slave node address <p>Attached information 3: Error Location Details</p> <ul style="list-style-type: none"> • When the attached information 1 is 000B hex 0: OMRON Communications Coupler Unit Not 0: Unit number of NX Unit • Index or subindex of CoE, when the attached information 1 is 0007 hex <p>Attached information 4: Cause of the error</p> <ul style="list-style-type: none"> • When the attached information 1 is 000B hex 2: Communications with the Communications Coupler Unit or NX Unit failed. • Abort code, when the attached information 1 is 0007 hex 		
Precautions/Remarks	None		

*1. This event code occurs for project unit version 1.40 or later. For a CPU Unit with unit version 1.03 or later and project unit version earlier than 1.40, refer to the description of the event code 102F0000 hex.

*2. "n" is 512 for an NX701 CPU Unit, 256 for an NX502 CPU Unit, and 192 for the NX102, NX1P2, and NJ-series CPU Units.

Event name	EtherCAT Slave Restore Operation Failed (Project unit version 1.40 or later)* ¹		Event code	10470002 hex* ¹	
Meaning	The restore operation for an EtherCAT slave ended in an error.				
Source	EtherCAT Master Function Module		Source details	Master	Detection timing During restore operation
Error attributes	Level	Observation	Recovery	---	Log category System
Effects	User program	Continues.	Operation	Not affected.	
Indicators	EtherCAT NET RUN		EtherCAT NET ERR		EtherCAT LINK/ACT
	---		---		---
System-defined variables	Variable	Data type		Name	
	None	---		---	
Cause and correction	Assumed cause		Correction		Prevention
	One of the following 1) to 6) occurred. Identify the cause of the error according to the attached information 1.				
	1) The EtherCAT master cannot start restore operation. (When the attached information 1 is 0002 hex)		The restore operation cannot be started due to the other event that is being occurred in the EtherCAT Function Module. Check the event that is being occurred, identify the error cause and make the correction.		Refer to the information on the event that occurred, implement preventive measures for the error cause, and then execute the restore operation.
	2) The EtherCAT network configuration in the backup data does not agree with the physical network configuration. (When the attached information 1 is 0009 hex)		If any of the following events occur, identify the error cause and make the correction according to the information on the event that occur. <ul style="list-style-type: none"> • Link OFF Error • Network Configuration Verification Error (Slave Unconnected) • Network Configuration Verification Error (Mismatched Slave) • Network Configuration Verification Error (Incorrect Wiring) • Network Configuration Verification Error (Incorrect Ring Wiring) • Illegal Slave Disconnection Detected • Incorrect Wiring Detected • Ring Disconnection Detected 		Make sure that the EtherCAT network configuration in the backup data agrees with the physical network configuration before you restore the data.
	3) It was not possible to write the backup parameters to the EtherCAT slave. (When the attached information 1 is 0007 hex)		Ask the manufacturer of the slave if you can write all of the parameters that are set as backup parameters in the order displayed on the Backup Parameter Edit Pane for the slave. On the Backup Parameter Edit Pane, sort the parameters if they must be written in a certain order and delete any parameters that cannot be written.		None

	<p>4) The request to the EtherCAT slave failed. (When the attached information 1 is 0004 hex)</p>	<p>a. Identify the error cause and make the correction according to the information on the event that occurred in the EtherCAT slave.</p> <p>b. Check the number of error frames in the slave diagnostic and statistical information. Check whether the contact failure of the connector, connection failure of the cable, or noise occurred in the location where an error frame was counted and implement countermeasures.</p>	<p>a. Refer to the information on the event occurred, and implement preventive measures for the error cause.</p> <p>b. Make sure that error frames are no longer counted in the diagnostic and statistical information for the master and slaves. If the error frame is counted, check whether the connection failure of the cable, contact failure of the connector, or noise occurred and implement countermeasures.</p>
	<p>5) Incorrect backup data was detected. (When the attached information 1 is 0008 hex)</p>	<p>Create the backup files again. If you fail to create the backup files again, format the SD Memory Card with the Sysmac Studio and then place the backup files on it.</p>	<p>Do not remove the SD Memory Card or turn OFF the power supply while the SD BUSY indicator is lit. Or, replace the SD Memory Card periodically according to the write life of the SD Memory Card.</p>

	<p>6) An error occurred at an OMRON Communications Coupler Unit. (When attached information 1 is 000B hex) The following causes are possible.</p> <ul style="list-style-type: none"> • Reading a backup file failed at the Communications Coupler Unit (when attached information 4 is 1). • Communications with the Communications Coupler Unit or NX Unit failed (when attached information 4 is 2). • The Unit Configuration of the NX Units in the Communications Coupler Unit when data was backed up did not agree with the actual configuration of NX Units (when attached information 4 is 3). 	<ul style="list-style-type: none"> • (When attached information 4 is 1) Try backing up the data again. • When attached information 4 is 2 <ul style="list-style-type: none"> a) A communication is not possible with the Communications Coupler Unit due to an event that occurred in the master or the Communications Coupler Unit. Identify the cause and make the correction according to the information on the event that occurred. b) Mount the NX Unit securely. c) Check the number of error frames in the slave diagnostic and statistical information. Check whether the contact failure of the connector, connection failure of the cable, or noise occurred in the location where an error frame was counted and implement countermeasures. d) If the above situation a) to d) does not improve, replace the Communications Coupler Unit or the NX Unit. If the problem still exists after you make the corrections a) to d), replace the Communications Coupler Unit or the NX Unit. • When attached information 4 is 3 <ul style="list-style-type: none"> a) Make the Unit Configuration of the NX Units in the Communications Coupler Unit when data was backed up agree with the actual configuration of NX Units. b) Correct the hardware switches on the Communications Coupler Unit so that they are the same as when the data was backed up. 	<ul style="list-style-type: none"> • When attached information 4 is 1 <ul style="list-style-type: none"> a) Do not edit the backup files. b) Format an SD Memory Card with the Sysmac Studio and then place the backup file on it. Also, do not remove the SD Memory Card or turn OFF the power supply while the SD BUSY indicator is lit. • When attached information 4 is 2 <ul style="list-style-type: none"> a) Take preventive measures for the cause of the event that occurred in the master or the Communications Coupler Unit. b) Mount the NX Unit securely. c) Refer to (b) in 4) above. • (When attached information 4 is 3) Restore the data while the hardware switches on the Communications Coupler Unit are the same as when the data was backed up.
--	---	---	---

Attached information	<p>Attached Information 1: Error Details</p> <ul style="list-style-type: none"> • 0002 hex: The restore operation failed to start. • 0004 hex: The request to the EtherCAT slave failed. • 0007 hex: Writing the backup data failed. • 0008 hex: The backup data is not correct. • 0009 hex: The network configuration does not agree with the network configuration in the backup data. • 000B hex: Error at OMRON Communications Coupler Unit <p>Attached Information 2: Error Location</p> <ul style="list-style-type: none"> • 0: Master • Not 0: Slave node address <p>Attached information 3: Error Location Details</p> <ul style="list-style-type: none"> • When the attached information 1 is 000B hex 0: OMRON Communications Coupler Unit Not 0: Unit number of NX Unit • Index or subindex of CoE, when the attached information 1 is 0007 hex <p>Attached information 4: Cause of the error</p> <ul style="list-style-type: none"> • When the attached information 1 is 000B hex 1: Reading the backup file failed. 2: Communications with the Communications Coupler Unit or NX Unit failed. 3: The Unit Configuration does not agree with the Unit Configuration in the backup data. • Abort code, when the attached information 1 is 0007 hex
Precautions/Remarks	None

*1. This event code occurs for project unit version 1.40 or later. For a CPU Unit with unit version 1.03 or later and project unit version earlier than 1.40, refer to the description of the event code 10300000 hex.

Event name	Emergency Message Detected		Event code	64200000 hex	
Meaning	An emergency message was detected.				
Source	EtherCAT Master Function Module	Source details	Slave	Detection timing	During communications
Error attributes	Level	Observation	Recovery	---	Log category
Effects	User program	Continues.	Operation	Slave: An error occurred. Other operation is not affected.	
Indicators	EtherCAT NET RUN		EtherCAT NET ERR		EtherCAT LINK/ACT
	---		---		---
System-defined variables	Variable		Data type		Name
	_EC_SlavEmergErr		BOOL		Emergency Message Detected
Cause and correction	Assumed cause		Correction		Prevention
	An emergency message was received from a slave.		Refer to the attached information 1 to check the emergency code of the slave where the error occurred. Refer to the manual for the slave to remove the cause of the error of the code and then reset the error.		Refer to the manual for the slave to take preventive measures.
Attached information	<p>Attached Information 1: Slave emergency code</p> <p>Attached information 2: Slave error register object value</p> <p>Attached Information 3: Slave emergency data. Only the lower five bytes are valid.</p>				
Precautions/Remarks	None				

Event name	EtherCAT Message Error		Event code	842D0000 hex*1		
Meaning	An error occurred in a message communications with the slave.					
Source	EtherCAT Master Function Module	Source details	Master	Detection timing	During communications	
Error attributes	Level	Observation	Recovery	---	Log category	System
Effects	User program	Continues.	Operation	Slave: An error occurred. Other operation is not affected.		
Indicators	EtherCAT NET RUN		EtherCAT NET ERR		EtherCAT LINK/ACT	
	---		---		---	
System-defined variables	Variable	Data type		Name		
	_EC_MsgErr	BOOL		EtherCAT Message Error		
Cause and correction	Assumed cause		Correction		Prevention	
	Refer to the attached information to check the error.		Send messages only to slaves that support the message protocol. Identify the error message with the error details that are given in the attached information, and correct the message.		Use messages that match the slave specifications. Also check to make sure that messages are addressed to the correct node.	
Attached information	<p>Attached Information 1: Error Details</p> <ul style="list-style-type: none"> 1st byte: 00 hex: Error message reception, 02 hex: Illegal or unsupported message discarded, 04 hex: Message with illegal destination address discarded 2nd byte: <ul style="list-style-type: none"> For Transmission: 00 hex: Error, 01 hex: VoE (AoE), 02 hex: EoE, 03 hex: CoE, 04 hex: FoE, 05 hex: SoE, 0F hex: VoE For Reception: 80 hex: Error, 81 hex: VoE (AoE), 82 hex: EoE, 83 hex: CoE, 84 hex: FoE, 85 hex: SoE, 8F hex: VoE <p>Attached information 2: Source node address. If the destination is the master: 0</p> <p>Attached Information 3: Transmission destination node address. If the destination is the master: 0</p> <p>Attached information 4: Error service data. This data is valid only when byte 2 of attached information 1 is 00 or 80 hex.</p>					
Precautions/Remarks	None					

*1. This event code occurs for project unit version earlier than 1.40.

Event name	Illegal Mailbox Received		Event code	84350000 hex*1	
Meaning	An illegal mailbox was received from a slave.				
Source	EtherCAT Master Function Module	Source details	Slave	Detection timing	During communications
Error attributes	Level	Observation	Recovery	Error reset	Log category System
Effects	User program	Continues.	Operation	Operation is not affected.	
Indicators	EtherCAT NET RUN		EtherCAT NET ERR		EtherCAT LINK/ACT
	---		---		---
System-defined variables	Variable		Data type		Name
	_EC_MsgErr		BOOL		EtherCAT Message Error
Cause and correction	Assumed cause		Correction		Prevention
	A message with illegal destination address was received from a slave. (When attached information 1 is 0002 hex)		Confirm that the destination of the message is an EtherCAT slave that is in the network configuration information. Send the message to an EtherCAT slave that is in the network configuration information.		Confirm that the destination of the message is an EtherCAT slave that is in the network configuration information.
Attached information	Attached Information 1: Error Details <ul style="list-style-type: none"> • 0002 hex: Message with illegal destination address received • Not 0002 hex: System information Attached information 2: Source slave node address Attached information 3: Destination slave node address (If the source is the master: 0) Attached information 4: System information				
Precautions/Remarks	None				

*1. This event code occurs for project unit version 1.40 or later.

Event name	Ring Disconnection Detected		Event code	84390000 hex ^{*1}	
Meaning	A ring disconnection status was detected.				
Source	EtherCAT Master Function Module		Source details	Master	Detection timing
					At power ON, at Controller reset, or during communications
Error attributes	Level	Observation	Recovery	---	Log category
					System
Effects	User program	Continues.	Operation	Master: Operation continues. Slave: Process data communications continue.	
Indicators	EtherCAT NET RUN		EtherCAT NET ERR		EtherCAT LINK/ACT
	---		---		---
System-defined variables	Variable	Data type		Name	
	_EC_RingBreaking	BOOL		Ring Disconnection	
	_EC_RingBreakNodeAdr	UINT		Slave Node Address Before Ring Disconnection	
Cause and correction	Assumed cause		Correction		Prevention
	One of the following 1) to 5) occurred in the ring topology.		Make the following corrections on cable connection between the slave shown in attached information 1 and the next slave in the ring topology. For how to correct errors for events related to the ring topology, refer to <i>A-8 Correction of Wiring for the EtherCAT Ring Topology Based on Event</i> on page A-306 in the appendices of the .		
	1) An Ethernet cable was disconnected.		Connect the cable.		None
	2) An Ethernet cable connector between slaves is disconnected.		Connect the connector.		<ul style="list-style-type: none"> Firmly connect the Ethernet connector until it clicks into place. Confirm that the Ethernet connector is mated securely.
	3) A non-recommended cable was used.		Replace the Ethernet cable with a recommended one.		Use recommended cables.
	4) The Ethernet cable is broken between slaves.		Replace the Ethernet cable.		Before you start wiring Ethernet cables, use the cable tester or other devices to confirm that there is no broken cable. Check the EtherCAT Network Wiring in the <i>NJ/NX-series CPU Unit Built-in EtherCAT Port User's Manual (Cat. No. W505)</i> for precautions on wiring.
	5) The contact of the Ethernet cable connector is faulty, or parts are faulty.		Replace the Ethernet cable.		None
Attached information	Attached information 1: Slave node address before point of break				
Precautions/Remarks	None				

*1. This event code occurs for project unit version 1.40 or later.

Event name	Slave Disconnected		Event code	94400000 hex	
Meaning	A slave was disconnected for a disconnection command.				
Source	EtherCAT Master Function Module	Source details	Slave	Detection timing	When slave disconnection is specified during communications
Error attributes	Level	Information	Recovery	---	Log category Access
Effects	User program	Continues.	Operation	<p>For project unit version earlier than 1.40: Master: The master changes the slave to the Init state. Slave: Message communications and process data communications are not possible.</p> <p>For project unit version 1.40 or later: Master: The master changes the slave to the Pre-Operational state. Slave: Message communications are possible. Process data communications are not possible.</p>	
Indicators	EtherCAT NET RUN		EtherCAT NET ERR		EtherCAT LINK/ACT
	---		---		---
System-defined variables	Variable	Data type		Name	
	_EC_DisconnSlavTbl	ARRAY [1..n] OF BOOL *1		Disconnected Slave Table	
	_EC_PDSlavTbl	ARRAY [1..n] OF BOOL *1		Process Data Communicating Slave Table	
	_EC_MBXSlavTbl	ARRAY [1..n] OF BOOL *1		Message Communications Enabled Slave Table	
	_EC_PDActive	BOOL		Process Data Communications Status	
Cause and correction	Assumed cause	Correction		Prevention	
	An operation to disconnect the slave was executed from the Sysmac Studio.	---		---	
	The EC_DisconnectSlave instruction was executed.	---		---	
Attached information	None				
Precautions/Remarks	None				

*1. "n" is 512 for an NX701 CPU Unit, 256 for an NX502 CPU Unit, and 192 for the NX102, NX1P2, and NJ-series CPU Units.

Event name	Slave Connected		Event code	94410000 hex		
Meaning	A slave was reconnected for a reconnection command.					
Source	EtherCAT Master Function Module	Source details	Slave	Detection timing	When slave reconnection is specified during communications	
Error attributes	Level	Information	Recovery	---	Log category	Access
Effects	User program	Continues.	Operation	Master: The master changes the slave to the Operational state. Slave: Message communications and process data communications are not possible.		
Indicators	EtherCAT NET RUN		EtherCAT NET ERR		EtherCAT LINK/ACT	
	---		---		---	
System-defined variables	Variable	Data type		Name		
	_EC_DisconnSlavTbl	ARRAY [1..n] OF BOOL *1		Disconnected Slave Table		
	_EC_PDSlavTbl	ARRAY [1..n] OF BOOL *1		Process Data Communicating Slave Table		
	_EC_MBXSlavTbl	ARRAY [1..n] OF BOOL *1		Message Communications Enabled Slave Table		
	_EC_PDActive	BOOL		Process Data Communications Status		
Cause and correction	Assumed cause		Correction		Prevention	
	An operation to reconnect the slave was executed from the Sysmac Studio.		---		---	
	The EC_ConnectSlave instruction was executed.		---		---	
Attached information	None					
Precautions/Remarks	None					

*1. "n" is 512 for an NX701 CPU Unit, 256 for an NX502 CPU Unit, and 192 for the NX102, NX1P2, and NJ-series CPU Units.

Event name	Error Reset		Event code	94430000 hex		
Meaning	A command was received to reset errors.					
Source	EtherCAT Master Function Module	Source details	Master	Detection timing	When errors are reset	
Error attributes	Level	Information	Recovery	---	Log category	Access
Effects	User program	Continues.	Operation	<p>Master: The current errors are reset and the network is verified again. If the error is not detected again, the master changes the slave for which communications were stopped to the Operational state.</p> <p>Slave: For slaves that the error occurred, message communications and process data communications are possible.</p>		
Indicators	EtherCAT NET RUN	EtherCAT NET ERR		EtherCAT LINK/ACT		
	---	---		---		
System-defined variables	Variable	Data type		Name		
	_EC_PDslavTbl	ARRAY [1..n] OF BOOL *1		Process Data Communicating Slave Table		
	_EC_MBXslavTbl	ARRAY [1..n] OF BOOL *1		Message Communications Enabled Slave Table		
	_EC_CommErrTbl	ARRAY [1..n] OF BOOL *1		Communications Error Slave Table		
	_EC_PDActive	BOOL		Process Data Communications Status		
Cause and correction	Assumed cause		Correction		Prevention	
	An error reset operation was performed from the Sysmac Studio.		---		---	
	The ResetECError instruction was executed.		---		---	
Attached information	None					
Precautions/Remarks	None					

*1. "n" is 512 for an NX701 CPU Unit, 256 for an NX502 CPU Unit, and 192 for the NX102, NX1P2, and NJ-series CPU Units.

Event name	Slave Disabled		Event code	94440000 hex ^{*1}		
Meaning	The EtherCAT Slave was disabled.					
Source	EtherCAT Master Function Module	Source details	Slave	Detection timing	At execution of setting instruction	
Error attributes	Level	Information	Recovery	---	Log category	Access
Effects	User program	Continues.	Operation	Master: The master changes the relevant slave to the Pre-Operational state. Slave: Message communications are possible. Process data communications are not possible.		
Indicators	EtherCAT NET RUN		EtherCAT NET ERR		EtherCAT LINK/ACT	
	---		---		---	
System-defined variables	Variable	Data type	Name			
	_EC_PDSlaveTbl	ARRAY [1..n] OF BOOL ^{*2}	Process Data Communicating Slave Table			
	_EC_DisableSlaveTbl	ARRAY [1..n] OF BOOL ^{*2}	Disabled Slave Table			
Cause and correction	Assumed cause	Correction	Prevention			
	The EC_ChangeEnableSetting instruction was executed.	---	---			
Attached information	None					
Precautions/Remarks	None					

*1. This event code occurs for unit version 1.04 or later of the CPU Unit.

*2. "n" is 512 for an NX701 CPU Unit, 256 for an NX502 CPU Unit, and 192 for the NX102, NX1P2, and NJ-series CPU Units.

Event name	Slave Enabled		Event code	94450000 hex*1	
Meaning	The EtherCAT slave was enabled.				
Source	EtherCAT Master Function Module	Source details	Slave	Detection timing	At execution of setting instruction
Error attributes	Level	Information	Recovery	---	Log category Access
Effects	User program	Continues.	Operation	Master: The master changes the relevant slave to the Operational state again. Slave: Message communications and process data communications are possible.	
Indicators	EtherCAT NET RUN	EtherCAT NET ERR		EtherCAT LINK/ACT	
	---	---		---	
System-defined variables	Variable	Data type	Name		
	_EC_PDSlavTbl	ARRAY [1..n] OF BOOL *2	Process Data Communicating Slave Table		
	_EC_DisableSlavTbl	ARRAY [1..n] OF BOOL *2	Disabled Slave Table		
Cause and correction	Assumed cause	Correction	Prevention		
	The EC_ChangeEnableSetting instruction was executed.	---	---		
Attached information	None				
Precautions/Remarks	None				

*1. This event code occurs for unit version 1.04 or later of the CPU Unit.

*2. "n" is 512 for an NX701 CPU Unit, 256 for an NX502 CPU Unit, and 192 for the NX102, NX1P2, and NJ-series CPU Units.

Event name	EtherCAT Diagnosis/Statistics Log Started		Event code	94500000 hex*1		
Meaning	EtherCAT diagnosis/statistics log is started.					
Source	EtherCAT Master Function Module	Source details	Master	Detection timing	When EtherCAT diagnosis/statistics log is started	
Error attributes	Level	Information	Recovery	---	Log category	Access
Effects	User program	Continues.	Operation	The response time to non-synchronous EtherCAT slaves will be extended.		
Indicators	EtherCAT NET RUN		EtherCAT NET ERR		EtherCAT LINK/ACT	
	---		---		---	
System-defined variables	Variable	Data type		Name		
	_EC_StatisticsLogEnable	BOOL		Diagnosis/Statistics Log Enable		
	_EC_StatisticsLogBusy	BOOL		Diagnosis/Statistics Log Busy		
Cause and correction	Assumed cause		Correction		Prevention	
	The value of the <i>_EC_StatisticsLogEnable</i> system-defined variable changed from FALSE to TRUE.		---		---	
Attached information	Attached information 1: Automatic saving interval to the SD Memory Card for the diagnosis/statistics log <ul style="list-style-type: none"> • 0: One-shot Mode • Not 0: Interval (sec) 					
Precautions/Remarks	None					

*1. This event code occurs for unit version 1.11 or later of the CPU Unit.

Event name	EtherCAT Diagnosis/Statistics Log Ended		Event code	94510000 hex*1		
Meaning	EtherCAT diagnosis/statistics log is ended.					
Source	EtherCAT Master Function Module	Source details	Master	Detection timing	When EtherCAT diagnosis/statistics log is ended	
Error attributes	Level	Information	Recovery	---	Log category	Access
Effects	User program	Continues.	Operation	Not affected.		
Indicators	EtherCAT NET RUN		EtherCAT NET ERR		EtherCAT LINK/ACT	
	---		---		---	
System-defined variables	Variable		Data type		Name	
	_EC_StatisticsLogEnable		BOOL		Diagnosis/Statistics Log Enable	
	_EC_StatisticsLogBusy		BOOL		Diagnosis/Statistics Log Busy	
	_EC_StatisticsLogErr		BOOL		Diagnosis/Statistics Log Error	
Cause and correction	Assumed cause		Correction		Prevention	
	An error that causes EtherCAT diagnosis/statistics log to end occurred.		---		---	
Attached information	<p>Attached information 1: Automatic saving interval to the SD Memory Card for the diagnosis/statistics log</p> <ul style="list-style-type: none"> • 0: One-shot Mode • Not 0: Interval (sec) <p>Attached information 2: Causes to end EtherCAT diagnosis/statistics log</p> <ul style="list-style-type: none"> • 1: The value of the <i>_EC_StatisticsLogEnable</i> system-defined variable changed from TRUE to FALSE. • 2: The 1000th record was saved in the log file. • 3: The SD Memory Card does not have sufficient available space to save another records in the log file. • 4: The SD Memory Card is write protected. • 5: The SD Memory Card cannot be recognized. • 6: Synchronization (download) or Clear All Memory operation is executed. • 7: An invalid value was specified to the automatic saving interval to the SD Memory Card for the diagnosis/statistics log. • 8: The diagnosis/statistics log was executed during execution of a master diagnostic and statistical information instruction (EC_GetMasterStatistics or EC_ClearMasterStatistics), or a slave diagnostic and statistical information instruction (EC_GetSlaveStatistics or EC_ClearSlaveStatistics). 					
Precautions/Remarks	None					

*1. This event code occurs for unit version 1.11 or later of the CPU Unit.

3-9 Errors in the OPC UA Function

This section provides tables of the errors (events) that can occur with the OPC UA function.

Refer to *NJ/NX-series CPU Unit OPC UA User's Manual (Cat. No. W588)* for information on the unit versions of CPU Units with which you can use the OPC UA function and corresponding Sysmac Studio versions.

3-9-1 Error Tables

OPC UA Server Function

Event code	Event name	Meaning	Assumed cause	Level					Reference
				M a j	P r t	M i n	O b s	I n f o	
15000000 hex (Ver. 1.17 or later) [NJ501-1□00] (Ver. 1.60 or later) [NX502-1□00] (Ver. 1.24 or later) [NX102-□□□□, NX701-1□□□]	Execution Log Save Failed	Failed to save the Execution Log to the SD Memory Card.	<ul style="list-style-type: none"> An SD Memory Card is not inserted. The SD Memory Card type is not correct. The format of the SD Memory Card is not correct. The SD Memory Card is write protected. The SD Memory Card does not have sufficient available space. The SD Memory Card is damaged. 				○	○	page 3-828
35D00000 hex (Ver. 1.17 or later) [NJ501-1□00] (Ver. 1.60 or later) [NX502-1□00] (Ver. 1.24 or later) [NX102-□□□□, NX701-1□□□]	OPC UA Server Setting Error	The OPC UA Server Settings are incorrect.	<ul style="list-style-type: none"> The power supply to the Controller was interrupted while the OPC UA Server Settings were being transferred. The power supply to the Controller was interrupted during a Clear All Memory operation. The OPC UA Server settings are not correct because the Controller was interrupted during a restore operation. TCP port number is duplicated. 				○		page 3-829
35D10000 hex (Ver. 1.17 or later) [NJ501-1□00] (Ver. 1.60 or later) [NX502-1□00] (Ver. 1.24 or later) [NX102-□□□□, NX701-1□□□]	Server Certificate Expired	The server certificate expired.	<ul style="list-style-type: none"> The period that is set in the server certificate expired. 				○	○	page 3-830

Event code	Event name	Meaning	Assumed cause	Level					Reference
				M a j	P r t	M i n	O b s	I n f o	
44180000 hex (Ver. 1.17 or later) [NJ501-1□□□] (Ver. 1.60 or later) [NX502-1□□□] (Ver. 1.24 or later) [NX102-□□□□, NX701-1□□□]	OPC UA System Processing Error	A fatal error was detected in the OPC UA Server.	<ul style="list-style-type: none"> A soft error occurred. 				○		page 3-830
44190000 hex (Ver. 1.17 or later) [NJ501-1□□□] (Ver. 1.60 or later) [NX502-1□□□] (Ver. 1.24 or later) [NX102-□□□□, NX701-1□□□]	OPC UA Server Insufficient Memory Capacity	The amount of variable data to be published has exceeded the amount of OPC UA server specification.	<ul style="list-style-type: none"> The amount of variable data to be published has exceeded the amount of OPC UA server specification. 				○		page 3-835
15020000 hex (Ver. 1.17 or later) [NJ501-1□□□] (Ver. 1.60 or later) [NX502-1□□□] (Ver. 1.24 or later) [NX102-□□□□, NX701-1□□□]	Server Certificate Mismatch	The IP address of the server certificate in the CPU Unit is not the same as that of the built-in EtherNet/IP port on the CPU Unit.	<p>The IP address of the built-in EtherNet/IP port of the CPU Unit was changed when the OPC Server Use Option is set to Use.</p> <ul style="list-style-type: none"> The IP address was changed by the ChangeIPAdr (Change IP Address) instruction. If the IP address setting method was <i>Obtain from BOOTP server</i>, the IP address was changed when the power is turned ON. A project containing a different IP address for the built-in EtherNet/IP port of the CPU Unit was downloaded to the CPU Unit. 				○		page 3-831
35D20000 hex (Ver. 1.17 or later) [NJ501-1□□□] (Ver. 1.60 or later) [NX502-1□□□] (Ver. 1.24 or later) [NX102-□□□□, NX701-1□□□]	Server Certificate Expiration Notice	The server certificate is close to expiring.	<ul style="list-style-type: none"> The period that is set in the server certificate is close to expiring. 				⊙ ○		page 3-832
35D30000 hex (Ver. 1.17 or later) [NJ501-1□□□] (Ver. 1.60 or later) [NX502-1□□□] (Ver. 1.24 or later) [NX102-□□□□, NX701-1□□□]	Too Many Public Variables	The number of variables that can be published to the OPC UA client exceeded the upper limit when the OPC UA Server was prepared.	<ul style="list-style-type: none"> When the OPC UA Server prepared the address space, the number of OPC UA variables exceeded the upper limit. 				○		page 3-832

Event code	Event name	Meaning	Assumed cause	Level					Reference
				M a j	P r t	M i n	O b s	I n f o	
35D40000 hex (Ver. 1.17 or later) [NJ501-1□00] (Ver. 1.60 or later) [NX502-1□00] (Ver. 1.24 or later) [NX102-□□□□, NX701-1□□□]	Unsupported Data Type/ Invalid Data	When the OPC UA server was built, variables or nodes with a data type that cannot be published to the OPC UA client were included.	<ul style="list-style-type: none"> Variables to be published had data types not yet supported by the OPC UA server. Or, reserved words for node names that cannot be published in the OPC UA address space were used for nodes corresponding to global variables, program names, and user-defined data type names. Unsupported data types and invalid data are as follows. <ul style="list-style-type: none"> Multidimensional array specified structure Structure containing multidimensional array(s) as member(s) Structure whose nesting number exceeds the limit value Union Array whose start number is not 0; e.g., Array[2..5] Variable whose size exceeds the limit value Array whose number of elements exceeds the limit value Structure whose number of members exceeds the limit value No variables that can be mapped Registered variable IDs are used. Unable to create namespace nodes 				○		page 3-833
35D50000 hex (Ver. 1.17 or later) [NJ501-1□00] (Ver. 1.60 or later) [NX502-1□00] (Ver. 1.24 or later) [NX102-□□□□, NX701-1□□□]	Too Many Public Value Attributes	The number of value attributes to be published to the OPC UA client exceeded the upper limit when the OPC UA Server was prepared.	<ul style="list-style-type: none"> When the OPC UA Server prepared the address space, the number of OPC UA value attributes has exceeded the upper limit. 				○		page 3-834

Event code	Event name	Meaning	Assumed cause	Level					Reference
				M a j	P r t	M i n	O b s	I n f o	
35D60000 hex (Ver. 1.17 or later) [NJ501-1□□□] (Ver. 1.60 or later) [NX502-1□□□] (Ver. 1.24 or later) [NX102-□□□□, NX701-1□□□]	Too Many Structure Definitions	The number of structure definitions to be published to the OPC UA client exceeded the upper limit when the OPC UA Server was prepared.	<ul style="list-style-type: none"> When the OPC UA Server prepared the address space, the number of structure definitions has exceeded the upper limit. 				○		page 3-835
85600000 hex (Ver. 1.17 or later) [NJ501-1□□□] (Ver. 1.60 or later) [NX502-1□□□] (Ver. 1.24 or later) [NX102-□□□□, NX701-1□□□]	OPC UA Client Connection Rejected	A connection request from an OPC UA client was rejected.	<ul style="list-style-type: none"> User authentication information was incorrect. The client certificate was incorrect. The client certificate was registered in the Rejected Certificate List. The CA certificate is not registered in the Trusted Certificate List for Client authentication or Issuer authentication. The number of sessions has exceeded the maximum number of connectable sessions. 				○		page 3-836
95D00000 hex (Ver. 1.17 or later) [NJ501-1□□□] (Ver. 1.60 or later) [NX502-1□□□] (Ver. 1.24 or later) [NX102-□□□□, NX701-1□□□]	OPC UA Server Started	The OPC UA Server started.	<ul style="list-style-type: none"> The OPC UA Server started. 				○		page 3-837
95D10000 hex (Ver. 1.17 or later) [NJ501-1□□□] (Ver. 1.60 or later) [NX502-1□□□] (Ver. 1.24 or later) [NX102-□□□□, NX701-1□□□]	OPC UA Server Stopped	The OPC UA Server stopped.	<ul style="list-style-type: none"> The OPC UA Server stopped. 				○		page 3-837

Event code	Event name	Meaning	Assumed cause	Level					Reference
				M a j	P r t	M i n	O b s	I n f o	
95D20000 hex (Ver. 1.17 or later) [NJ501-1□00] (Ver. 1.60 or later) [NX502-1□00] (Ver. 1.24 or later) [NX102-□□□□, NX701-1□□□]	Server Certificate Generated	A server certificate was generated. <ul style="list-style-type: none">The server certificate is automatically generated when there is no server certificate.The server private key and server certificate are automatically generated when Regenerate certificate is performed. *1	<ul style="list-style-type: none">A server certificate was generated.					○	page 3-838
95D30000 hex (Ver. 1.17 or later) [NJ501-1□00] (Ver. 1.60 or later) [NX502-1□00] (Ver. 1.24 or later) [NX102-□□□□, NX701-1□□□]	Client Certificate Discarded	Received client certificates were discarded.	<ul style="list-style-type: none">The maximum number of client certificates that can be registered in the Rejected Certificate List has been exceeded.					○	page 3-838
95D40000 hex (Ver. 1.17 or later) [NJ501-1□00] (Ver. 1.60 or later) [NX502-1□00] (Ver. 1.24 or later) [NX102-□□□□, NX701-1□□□]	OPC UA Server Certificate and Security Profile Cleared	The OPC UA server certificate and security profile were deleted.	<ul style="list-style-type: none">Restore was executed using a backup file created on a CPU Unit with unit version that does not have the OPC UA server function.A project was downloaded from a CPU Unit without the OPC UA Server.Checked <i>Clearing the OPC UA server certificate and security profile.</i> and performed Clear All Memory operation.					○	page 3-839
95D60000 hex (Ver.1.43 or later) [NJ501-1□00] (Ver. 1.60 or later) [NX502-1□00] (Ver. 1.43 or later) [NX102-□□00] (Ver. 1.36 or later) [NX102-□□20] (Ver. 1.24 or later) [NX701-1□□□]	Client Certificate Added	A client certificate was added.	A client certificate was added.					○	page 3-840

Event code	Event name	Meaning	Assumed cause	Level					Reference
				M a j	P r t	M i n	O b s	I n f o	
95D70000 hex (Ver. 1.43 or later) [NJ501-1□□0] (Ver. 1.60 or later) [NX502-1□□0] (Ver. 1.43 or later) [NX102-□□00] (Ver. 1.36 or later) [NX102-□□20] (Ver. 1.24 or later) [NX701-1□□□]	Client Certificate Deleted	A client certificate was deleted.	A client certificate was deleted.					○	page 3-840
95D80000 hex (Ver. 1.43 or later) [NJ501-1□□0] (Ver. 1.60 or later) [NX502-1□□0] (Ver. 1.43 or later) [NX102-□□00] (Ver. 1.36 or later) [NX102-□□20] (Ver. 1.24 or later) [NX701-1□□□]	Client Certificate Moved	A client certificate was moved to the Trusted Certificate.	A client certificate was moved to the Trusted Certificate.					○	page 3-841
95D90000 hex (Ver. 1.43 or later) [NJ501-1□□0] (Ver. 1.60 or later) [NX502-1□□0] (Ver. 1.43 or later) [NX102-□□00] (Ver. 1.36 or later) [NX102-□□20] (Ver. 1.24 or later) [NX701-1□□□]	Client Certificate Revocation List Added	The client certificate revocation list was added.	The client certificate revocation list was added.					○	page 3-841
95DA0000 hex (Ver. 1.43 or later) [NJ501-1□□0] (Ver. 1.60 or later) [NX502-1□□0] (Ver. 1.43 or later) [NX102-□□00] (Ver. 1.36 or later) [NX102-□□20] (Ver. 1.24 or later) [NX701-1□□□]	Client Certificate Revocation List Deleted	The client certificate revocation list was deleted.	The client certificate revocation list was deleted.					○	page 3-842

3 Error Descriptions and Corrections

Event code	Event name	Meaning	Assumed cause	Level					Reference
				M a j	P r t	M i n	O b s	I n f o	
95DB0000 hex (Ver. 1.49 or later) [NJ-series, NX102, NX1P2] (Ver. 1.60 or later) [NX502-1□00] (Ver. 1.29 or later) [NX701]	Server Certificate Re-generated	The server certificate was regenerated. • The server private key and server certificate are automatically generated when Regenerate certificate is performed.	• The server certificate was re-generated.					○	page 3-843
96200000 hex (Ver. 1.43 or later) [NJ501-1□00] (Ver. 1.60 or later) [NX502-1□00] (Ver. 1.43 or later) [NX102-□□00] (Ver. 1.36 or later) [NX102-□□20] (Ver. 1.24 or later) [NX701-1□□□]	Security Settings Transferred	The security settings were transferred.	The security settings were transferred.					○	page 3-844
96210000 hex (Ver. 1.43 or later) [NJ501-1□00] (Ver. 1.60 or later) [NX502-1□00] (Ver. 1.43 or later) [NX102-□□00] (Ver. 1.36 or later) [NX102-□□20] (Ver. 1.24 or later) [NX701-1□□□]	Execution Log Cleared	The Execution Log was cleared.	The Execution Log was cleared.					○	page 3-845
96220000 hex (Ver. 1.43 or later) [NJ501-1□00] (Ver. 1.60 or later) [NX502-1□00] (Ver. 1.43 or later) [NX102-□□00] (Ver. 1.36 or later) [NX102-□□20] (Ver. 1.24 or later) [NX701-1□□□]	CA Certificate Added	A CA certificate was added.	A CA certificate was added.					○	page 3-846

Event code	Event name	Meaning	Assumed cause	Level					Reference
				M a j	P r t	M i n	O b s	I n f o	
96230000 hex (Ver. 1.43 or later) [NJ501-1□□□] (Ver. 1.60 or later) [NX502-1□□□] (Ver. 1.43 or later) [NX102-□□□□] (Ver. 1.36 or later) [NX102-□□□□20] (Ver. 1.24 or later) [NX701-1□□□□]	CA Certificate Deleted	A CA certificate was deleted.	A CA certificate was deleted.					○	page 3-846
96240000 hex (Ver. 1.43 or later) [NJ501-1□□□] (Ver. 1.60 or later) [NX502-1□□□] (Ver. 1.43 or later) [NX102-□□□□] (Ver. 1.36 or later) [NX102-□□□□20] (Ver. 1.24 or later) [NX701-1□□□□]	CA Certificate Revocation List Added	The CA certificate revocation list was added.	The CA certificate revocation list was added.					○	page 3-847
96250000 hex (Ver. 1.43 or later) [NJ501-1□□□] (Ver. 1.60 or later) [NX502-1□□□] (Ver. 1.43 or later) [NX102-□□□□] (Ver. 1.36 or later) [NX102-□□□□20] (Ver. 1.24 or later) [NX701-1□□□□]	CA Certificate Revocation List Deleted	The CA certificate revocation list was deleted.	The CA certificate revocation list was deleted.					○	page 3-848

Event code	Event name	Meaning	Assumed cause	Level					Reference
				M a j	P r t	M i n	O b s	I n f o	
96260000 hex (Ver. 1.49 or later) [NJ-series, NX102, NX1P2] (Ver. 1.60 or later) [NX502-1□00] (Ver. 1.29 or later) [NX701]	Client Certificate or CA Certificate Changed	One of the following changes to the certificate has been made. <ul style="list-style-type: none"> • The client certificate was added, deleted, or moved. • The client certificate revocation list was added or deleted. • The CA certificate was added, deleted, or moved. • The CA certificate revocation list was added or deleted. 	One of the following changes to the certificate has been made. <ul style="list-style-type: none"> • The client certificate was added, deleted, or moved. • The client certificate revocation list was added or deleted. • The CA certificate was added, deleted, or moved. • The CA certificate revocation list was added or deleted. 					○	page 3-849

- *1. This applies to the following CPU Unit only.
- NJ501, NX102 CPU Unit: Version 1.48 or earlier
 - NX701 CPU Unit: Version 1.28 or earlier

OPC UA Instructions

The lower four digits of an event code give the error code for the instruction. For details of error codes, refer to the description of the corresponding event code. For example, for an error code, 16#5000, refer to the description for event code 54015000 hex.

Event code	Event name	Meaning	Assumed cause	Level					Reference
				M a j	P r t	M i n	O b s	I n f o	
54015000 hex (Ver. 1.17 or later) [NJ501-1□□□] (Ver. 1.60 or later) [NX502-1□□□] (Ver. 1.24 or later) [NX102-□□□□, NX701-1□□□]	OPC UA Server Shut- down or Shutting Down	The OPC UA Server was already shut- down or was being shut down.	<ul style="list-style-type: none"> The OPCUA_Shutdown (Shut- down OPC UA Function) in- struction was executed while the OPC UA Server was al- ready shut down. The OPCUA_Shutdown (Shut- down OPC UA Function) in- struction was executed while the OPC UA Server was being shut down. 				○		page 3-851
54015001 hex (Ver. 1.17 or later) [NJ501-1□□□] (Ver. 1.60 or later) [NX502-1□□□] (Ver. 1.24 or later) [NX102-□□□□, NX701-1□□□]	OPC UA Server Being Initialized	The OPCUA_Shut- down (Shutdown OPC UA Function) in- struction could not be executed because the OPC UA Server was being initialized.	<ul style="list-style-type: none"> The OPCUA_Shutdown (Shut- down OPC UA Function) in- struction was executed while the OPC UA Server was being initialized. 				○		page 3-852
54015002 hex (Ver. 1.17 or later) [NJ501-1□□□] (Ver. 1.60 or later) [NX502-1□□□] (Ver. 1.24 or later) [NX102-□□□□, NX701-1□□□]	OPC UA Server Not Started	The relevant instruc- tion could not be exe- cuted because the OPC UA Server had not been started.	<ul style="list-style-type: none"> When the Server Use Option is set to <i>Do not use</i>, the relevant instruction was executed. 				○		page 3-853

3-9-2 Error Descriptions

OPC UA Server Function

Event name	Execution Log Save Failed		Event code	15000000 hex	
Meaning	Failed to save the Execution Log to the SD Memory Card.				
Source	PLC Function Module	Source details	OPC UA Server	Detection timing	Continuously
Error attributes	Level	Minor fault		Log category	System
	Recovery	Automatic recovery			
Effects	User program	Continues.	Operation	Not affected.	
System-defined variables	Variable	Data type		Name	
	None	---		---	
Cause and correction	Assumed cause	Correction		Prevention	
	An SD Memory Card is not inserted.	Insert an SD Memory Card.		Insert an SD Memory Card.	
	The SD Memory Card type is not correct.	Replace the SD Memory Card with an SD or SDHC card.		Use an SD or SDHC card.	
	The format of the SD Memory Card is not correct.	Format the SD Memory Card with the Sysmac Studio.		Use a formatted SD Memory Card. Also, do not remove the SD Memory Card or turn OFF the power supply while the SD BUSY indicator is lit.	
	The SD Memory Card is write protected.	Remove write protection from the SD Memory Card.		Make sure that the SD Memory Card is not write protected.	
	The capacity of the SD Memory Card is insufficient.	Replace the SD Memory Card for one with sufficient available capacity.		Replace the SD Memory Card for one with sufficient available capacity.	
	The SD Memory Card is damaged.	Replace the SD Memory Card.		Do not remove the SD Memory Card or turn OFF the power supply while the SD BUSY indicator is lit. Replace the SD Memory Card periodically according to the write life of the SD Memory Card. Do not remove the SD Memory Card while the SD PWR indicator is lit.	
Attached information	<p>Attached Information 1: Error Details</p> <ul style="list-style-type: none"> • 0001 hex: An SD Memory Card is not inserted • 0002 hex: The SD Memory Card is faulty, the format of the SD Memory Card is not correct, or the SD Memory Card type is not correct. • 0003 hex: The SD Memory Card is write protected. • 0005 hex: There is not sufficient space available on the SD Memory Card. • 0302 hex: A file was not successfully saved to the SD Memory Card due to other factors, or the SD Memory Card is damaged. 				
Precautions/Remarks	None				

Event name	OPC UA Server Setting Error		Event code	35D00000 hex	
Meaning	The OPC UA Server Settings are incorrect.				
Source	PLC Function Module	Source details	OPC UA Server	Detection timing	At Download, at CPU Unit power ON, at Controller reset
Error attributes	Level	Minor fault		Log category	System
	Recovery	Automatic recovery			
Effects	User program	Continues.	Operation	<ul style="list-style-type: none"> • The OPC UA Server cannot be started. • The operating status of the OPC UA Server will move to the Halt error state. 	
	System-defined variables	Variable	Data type	Name	
		None	---	---	
Cause and correction	Assumed cause	Correction		Prevention	
	<ul style="list-style-type: none"> • The power supply to the Controller was interrupted while the OPC UA Server Settings were being transferred. • The power supply to the Controller was interrupted during a Clear All Memory operation. • The OPC UA Server settings are not correct because the Controller was interrupted during a restore operation. 	Transfer the OPC UA Server Settings again with the Sysmac Studio.		None	
	TCP port number is duplicated.	Do not set the same port number as that of the socket communications instructions or FTP server settings.		Do not set the same port number as that of the socket communications instructions or FTP server settings.	
Attached information	None				
Precautions/Remarks	None				

Event name	Server certificate Expired		Event code	35D10000 hex	
Meaning	The server certificate expired.				
Source	PLC Function Module	Source details	OPC UA Server	Detection timing	At Download, at CPU Unit power ON, at Controller reset, or Periodically (every 24 hours)
Error attributes	Level	Minor fault		Log category	System
	Recovery	Automatic recovery			
Effects	User program	Continues.	Operation	Not affected.	
System-defined variables	Variable	Data type		Name	
	None	---		---	
Cause and correction	Assumed cause		Correction		Prevention
	The period that is set in the server certificate expired.		Regenerate the server certificate.		Consider the expiration date of the server certificate.
Attached information	Attached Information 1: The expiration date of the server certificate • "YYYY-MM-DD HH:MM:SS"				
Precautions/Remarks	This event will not be registered in duplicate until the power supply to the Controller is cycled or the Controller is reset or the Server certificate is regenerated.				

Event name	OPC UA System Processing Error		Event code	44180000 hex	
Meaning	A fatal error was detected in the OPC UA Server.				
Source	PLC Function Module	Source details	OPC UA Server	Detection timing	---
Error attributes	Level	Minor fault		Log category	System
	Recovery	---			
Effects	User program	Continues.	Operation	Not affected.	
System-defined variables	Variable	Data type		Name	
	None	---		---	
Cause and correction	Assumed cause		Correction		Prevention
	A soft error occurred.		Cycle the power supply to the Controller, or reset the Controller.		---
Attached information	None				
Precautions/Remarks	None				

Event name	Server Certificate Mismatch		Event code	15020000 hex	
Meaning	The IP address of the server certificate in the CPU Unit is not the same as that of the built-in EtherNet/IP port on the CPU Unit.				
Source	PLC Function Module	Source details	OPC UA Server	Detection timing	At CPU Unit power ON, at Controller reset, at Download, or Periodically (every 24 hours)
Error attributes	Level	Observation	Log category	System	
	Recovery	---			
Effects	User program	Continues.	Operation	Not affected.	
System-defined variables	Variable	Data type		Name	
	None	---		---	
Cause and correction	Assumed cause	Correction		Prevention	
	The IP address of the built-in EtherNet/IP port of the CPU Unit was changed when the OPC UA Server Use Option is set to Use. <ul style="list-style-type: none"> The IP address was changed by the ChangeIPAdr (Change IP Address) instruction. If the IP address setting method was Obtain from BOOTP server, the IP address was changed when the power is turned ON. A project containing a different IP address for the built-in EtherNet/IP port of the CPU Unit was downloaded to the CPU Unit. 	Restore the IP address of the built-in EtherNet/IP port on the CPU Unit, or regenerate the server certificate.		Regenerate the server certificate after changing the IP address of the built-in EtherNet/IP port on the CPU Unit.	
Attached information	Attached Information 1: The IP address of the server certificate				
Precautions/Remarks	This event will not be registered in duplicate until the power supply to the Controller is cycled or the Controller is reset or the Server certificate is regenerated.				

Event name	Server Certificate Expiration Notice		Event code	35D20000 hex	
Meaning	The server certificate is close to expiring.				
Source	PLC Function Module	Source details	OPC UA Server	Detection timing	At CPU Unit power ON, at Controller reset, or Periodically (every 24 hours)
Error attributes	Level	Observation		Log category	System
	Recovery	---			
Effects	User program	Continues.	Operation	Not affected.	
System-defined variables	Variable	Data type		Name	
	None	---		---	
Cause and correction	Assumed cause		Correction		Prevention
	The period that is set in the server certificate is close to expiring.		Regenerate the server certificate.		Consider the expiration date of the server certificate.
Attached information	Attached Information 1: The expiration date of the server certificate <ul style="list-style-type: none"> "YYYY-MM-DD HH:MM:SS" 				
Precautions/Remarks	This event will not be registered in duplicate until the power supply to the Controller is cycled or the Controller is reset or the Server certificate is regenerated.				

Event name	Too Many Public Variables		Event code	35D30000 hex	
Meaning	The number of variables that can be published to the OPC UA client exceeded the upper limit when the OPC UA Server was prepared.				
Source	PLC Function Module	Source details	OPC UA Server	Detection timing	At CPU Unit power ON, at Controller reset, restore operation, at download, or online editing
Error attributes	Level	Observation		Log category	System
	Recovery	---			
Effects	User program	Continues.	Operation	Not affected.	
System-defined variables	Variable	Data type		Name	
	None	---		---	
Cause and correction	Assumed cause		Correction		Prevention
	When the OPC UA Server prepared the address space, the number of OPC UA variables has exceeded the upper limit.		Reduce the number of variables to be published to the OPC UA client to below the upper limit.		Reduce the number of variables to be published to the OPC UA client to below the upper limit.
Attached information	None				
Precautions/Remarks	This event does not occur if the OPC UA Server Use Option is set to Do not use or when you use a project not compatible with the OPC UA Server.				

Event name	Unsupported Data Type/Invalid Data		Event code	35D40000 hex	
Meaning	When the OPC UA server was built, variables or nodes with a data type that cannot be published to the OPC UA client were included.				
Source	PLC Function Module	Source details	OPC UA Server	Detection timing	At CPU Unit power ON, at Controller reset, restore operation, at download, or online editing
Error attributes	Level	Observation	Log category	System	
	Recovery	---			
Effects	User program	Continues.	Operation	Not affected.	
System-defined variables	Variable	Data type		Name	
	None	---		---	
Cause and correction	Assumed cause	Correction		Prevention	
	<p>Variables to be published had data types not yet supported by the OPC UA server. Or, reserved words for node names that cannot be published in the OPC UA address space were used for nodes corresponding to global variables, program names, and user-defined data type names. Unsupported data types and invalid data are as follows.</p> <ul style="list-style-type: none"> • Multidimensional array specified structure • Structure containing multidimensional array(s) as member(s) • Structure whose nesting number exceeds the limit value • Union • Array whose start number is not 0; e.g., Array[2..5] • Variable whose size exceeds the limit value • Array whose number of elements exceeds the limit value • Structure whose number of members exceeds the limit value • No variables that can be mapped • Registered variable IDs are used. • Unable to create namespace nodes 	<p>Change variables with the following data types to have data types that can be published. Or avoid using reserved word for node names that cannot be published in the OPC UA address space.</p> <ul style="list-style-type: none"> • Multidimensional array specified structure • Structure containing multidimensional array(s) as member(s) • Structure whose nesting number exceeds the limit value • Union • Array whose start number is not 0; e.g., Array[2..5] • Variable whose size exceeds the limit value • Array whose number of elements exceeds the limit value • Structure whose number of members exceeds the limit value • No variables that can be mapped • Registered variable IDs are used. • Unable to create namespace nodes 		<p>Change variables with the following data types to have data types that can be published. Or avoid using reserved word for node names that cannot be published in the OPC UA address space.</p> <ul style="list-style-type: none"> • Multidimensional array specified structure • Structure containing multidimensional array(s) as member(s) • Structure whose nesting number exceeds the limit value • Union • Array whose start number is not 0; e.g., Array[2..5] • Variable whose size exceeds the limit value • Array whose number of elements exceeds the limit value • Structure whose number of members exceeds the limit value • No variables that can be mapped • Registered variable IDs are used. • Unable to create namespace nodes 	

Attached information	<p>Attached information 1: Error Details</p> <ul style="list-style-type: none"> • Bit 00: Multidimensional array specified structure • Bit 01: Structure containing multidimensional structure(s) as member(s) • Bit 02: Structure whose nesting number exceeds the limit value • Bit 03: Union • Bit 04: Array whose start number is not 0; e.g., Array[2..5] • Bit 05: Variable whose size exceeds the limit value • Bit 06: Array whose number of elements exceeds the limit value • Bit 07: Structure whose number of members exceeds the limit value • Bit 08: No mapping variable • Bit 09: Registered variable ID • Bit 10: Incorrect namespace • Bit 11: Reserved words for node names that cannot be published in the OPC UA address space were used for nodes corresponding to global variables, program names, and user-defined data type names.
Precautions/Remarks	None

Event name	Too Many Public Value Attributes		Event code	35D50000 hex	
Meaning	The number of value attributes to be published to the OPC UA client exceeded the upper limit when the OPC UA Server was prepared.				
Source	PLC Function Module	Source details	OPC UA Server	Detection timing	At CPU Unit power ON, at Controller reset, restore operation, at download, or online editing
Error attributes	Level	Observation	Log category	System	
	Recovery	---			
Effects	User program	Continues.	Operation	Not affected.	
System-defined variables	Variable	Data type		Name	
	None	---		---	
Cause and correction	Assumed cause	Correction		Prevention	
	When the OPC UA Server prepared the address space, the number of OPC UA value attributes has exceeded the upper limit.	Check the number or data type of the network-published global variables and make it less than the maximum number of value attributes.		Check the number or data type of the network-published global variables and make it less than the maximum number of value attributes.	
Attached information	None				
Precautions/Remarks	None				

Event name	Too Many Structure Definitions		Event code	35D60000 hex	
Meaning	The number of structure definitions to be published to the OPC UA client exceeded the upper limit when the OPC UA Server was built.				
Source	PLC Function Module	Source details	OPC UA Server	Detection timing	At power ON, Controller reset, at restoration, when downloading or online editing
Error attributes	Level	Observation		Log category	System
	Recovery	---			
Effects	User program	Continues.	Operation	Not affected.	
System-defined variables	Variable	Data type		Name	
	None	---		---	
Cause and correction	Assumed cause	Correction		Prevention	
	When the OPC UA Server prepared the address space, the number of structure definitions has exceeded the upper limit.	Check the data type of the variable to be published, and reduce the number of structure definitions to below the upper limit.		Check the data type of the variable to be published, and reduce the number of structure definitions to below the upper limit.	
Attached information	None				
Precautions/Remarks	None				

Event name	OPC UA Server Insufficient Memory Capacity		Event code	44190000 hex	
Meaning	The amount of variable data to be published has exceeded the amount of OPC UA server specification.				
Source	PLC Function Module	Source details	OPC UA Server	Detection timing	During online editing or downloading, or when a variable is accessed from OPC UA client
Error attributes	Level	Minor fault		Log category	System
	Recovery	Automatic recovery			
Effects	User program	Continues.	Operation	Not affected.	
System-defined variables	Variable	Data type		Name	
	None	---		---	
Cause and correction	Assumed cause	Correction		Prevention	
	The amount of variable data to be published has exceeded the amount of OPC UA server specification.	Reduce the number of variable to publish.		---	
Attached information	None				
Precautions/Remarks	None				

Event name	OPC UA Client Connection Rejected		Event code	85600000 hex	
Meaning	A connection request from an OPC UA client was rejected.				
Source	PLC Function Module	Source details	OPC UA Server	Detection timing	When receiving a connection request from a OPC UA client
Error attributes	Level	Observation		Log category	System
	Recovery	---			
Effects	User program	Continues.	Operation	The OPC UA client cannot connect to the OPC UA Server.	
System-defined variables	Variable	Data type		Name	
	None	---		---	
Cause and correction	Assumed cause	Correction		Prevention	
	User authentication information was incorrect.	Use the correct user name and password.		Set the correct user name and password for OPC UA client.	
	The client certificate was incorrect.	Check that the client certificate registered in the CPU Unit is correct.		Register the correct client certificate in the CPU Unit.	
		Make sure the client certificate used by the OPC UA client is correct.		Register the correct client certificate in the CPU Unit.	
	The client certificate was registered in the Rejected Certificate List.	Register the client certificate to the Trusted Certificate List, and then reconnect.		Register to the Trusted Client List the certificate of the client to be connected.	
	The CA certificate is not registered in the Trusted Certificate List for Client authentication or Issuer authentication.	Register the CA certificate to the Trusted Certificate List for Client authentication or Issuer authentication, and then reconnect.		Register the CA certificate to the Trusted Certificate List for Client authentication or Issuer authentication.	
The number of sessions has exceeded the maximum number of connectable sessions.	Make sure the number of sessions is below the maximum connectable sessions.		Reconsider the configuration to make sure that the number of sessions is less than the maximum number of sessions that can be connected.		
Attached information	<p>Attached information 1: Reasons for connection rejected</p> <ul style="list-style-type: none"> • 01 hex: Incorrect user authentication information • 02 hex: Untrusted certificate • 04 hex: Maximum connectable sessions exceeded <p>Attached information 2: Details</p> <ul style="list-style-type: none"> • User name if the reason for connection rejected is set to 01 hex, as described above. 				
Precautions/Remarks	None				

Event name	OPC UA Server Started			Event code	95D00000 hex
Meaning	The OPC UA Server started.				
Source	PLC Function Module	Source details	OPC UA Serv- er	Detection tim- ing	At start of OPC UA Server
Error attrib- utes	Level	Information		Log category	System
	Recovery	---			
Effects	User program	Continues.	Operation	Not affected.	
System-de- fined varia- bles	Variable	Data type		Name	
	None	---		---	
Cause and correction	Assumed cause	Correction		Prevention	
	The OPC UA Server started.	None		None	
Attached in- formation	None				
Precautions/ Remarks	None				

Event name	OPC UA Server Stopped			Event code	95D10000 hex
Meaning	The OPC UA Server stopped.				
Source	PLC Function Module	Source details	OPC UA Serv- er	Detection tim- ing	At OPCUA_ Shutdown (Shutdown OPC UA Func- tion) instruc- tion execution, shutdown op- eration from the Sysmac Studio
Error attrib- utes	Level	Information		Log category	System
	Recovery	---			
Effects	User program	Continues.	Operation	The OPC UA Server stopped.	
System-de- fined varia- bles	Variable	Data type		Name	
	None	---		---	
Cause and correction	Assumed cause	Correction		Prevention	
	The OPC UA Server stopped.	None		None	
Attached in- formation	None				
Precautions/ Remarks	<ul style="list-style-type: none"> • This event is not registered when the OPC UA Server stops due to power OFF. • To start the OPC UA Server, cycle the power supply to the Controller or reset the Controller. 				

Event name	Server Certificate Generated		Event code	95D20000 hex	
Meaning	<p>A server certificate was generated.</p> <ul style="list-style-type: none"> The server certificate is automatically generated when there is no server certificate. The server private key and server certificate are automatically generated when Regenerate certificate is performed. *1 				
Source	PLC Function Module	Source details	OPC UA Server	Detection timing	When server certificate is generated
Error attributes	Level	Information		Log category	System
	Recovery	---			
Effects	User program	Continues.	Operation	Not affected.	
System-defined variables	Variable	Data type		Name	
	None	---		---	
Cause and correction	Assumed cause	Correction		Prevention	
	The server certificate was regenerated.	None		None	
Attached information	None				
Precautions/Remarks	None				

*1. This applies to the following CPU Unit only.

- NJ501, NX102 CPU Unit: Version 1.48 or earlier
- NX701 CPU Unit: Version 1.28 or earlier

Event name	Client Certificate Discarded		Event code	95D30000 hex	
Meaning	Received client certificates were discarded.				
Source	PLC Function Module	Source details	OPC UA Server	Detection timing	When receiving a connection request from a OPC UA client
Error attributes	Level	Information		Log category	System
	Recovery	---			
Effects	User program	Continues.	Operation	Not affected.	
System-defined variables	Variable	Data type		Name	
	None	---		---	
Cause and correction	Assumed cause	Correction		Prevention	
	The maximum number of client certificates that can be registered in the Rejected Certificate List has been exceeded.	Delete registered client certificates from the Rejected Certificate List.		Delete unnecessary client certificates from the Rejected Certificate List.	
Attached information	Attached information 1: The IP address of the discarded client certificate				
Precautions/Remarks	None				

Event name	OPC UA Server Certificate and Security Profile Cleared		Event code	95D40000 hex	
Meaning	The OPC UA Server certificate and Security Profile have been cleared.				
Source	PLC Function Module	Source details	OPC UA Server	Detection timing	At Download, restore operation, Clear All Memory operation with the relevant checkbox checked
Error attributes	Level	Information		Log category	System
	Recovery	---			
Effects	User program	Continues.	Operation	Not affected.	
System-defined variables	Variable	Data type		Name	
	None	---		---	
Cause and correction	Assumed cause	Correction		Prevention	
	<ul style="list-style-type: none"> • A restore was executed using a backup file created by a CPU Unit whose version does not support OPC UA Server. • A project was downloaded from a CPU Unit without OPC UA Server. • Checked Clearing the OPC UA server certificate and security profile. and performed Clear All Memory operation. 	---		---	
Attached information	None				
Precautions/Remarks	None				

Event name	Client Certificate Added			Event code	95D60000 hex
Meaning	A client certificate was added.				
Source	PLC Function Module	Source details	OPC UA Server	Detection timing	At successful client certificate addition
Error attributes	Level	Information		Log category	Access ^{*1}
	Recovery	---			
Effects	User program	Continues.	Operation	Not affected.	
System-defined variables	Variable	Data type		Name	
	None	---		---	
Cause and correction	Assumed cause		Correction		Prevention
	A client certificate was added.		None		None
Attached information	Attached information 1: The thumbprint of the added client certificate				
Precautions/Remarks	None				
User name in the access log	When the user authentication function is enabled: User name				
	When the user authentication function is disabled: NULL				

*1. This applies to the following CPU Unit only. This is System for other CPU Units.

- NJ-series, NX102, NX1P2 CPU Unit: Version 1.49 or later
- NX502 CPU Unit: Version 1.60 or later
- NX701 CPU Unit: Version 1.29 or later

Event name	Client Certificate Deleted			Event code	95D70000 hex
Meaning	A client certificate was deleted.				
Source	PLC Function Module	Source details	OPC UA Server	Detection timing	At successful client certificate deletion
Error attributes	Level	Information		Log category	Access ^{*1}
	Recovery	---			
Effects	User program	Continues.	Operation	Not affected.	
System-defined variables	Variable	Data type		Name	
	None	---		---	
Cause and correction	Assumed cause		Correction		Prevention
	A client certificate was deleted.		None		None
Attached information	Attached information 1: The thumbprint of the deleted client certificate Attached Information 2: The store location of the certificate <ul style="list-style-type: none"> • 0001 hex: Trusted Certificate • 0002 hex: Rejected Certificate 				
Precautions/Remarks	None				
User name in the access log	When the user authentication function is enabled: User name				
	When the user authentication function is disabled: NULL				

*1. This applies to the following CPU Unit only. This is System for other CPU Units.

- NJ-series, NX102, NX1P2 CPU Unit: Version 1.49 or later
- NX502 CPU Unit: Version 1.60 or later
- NX701 CPU Unit: Version 1.29 or later

Event name	Client Certificate Moved		Event code	95D80000 hex	
Meaning	A client certificate was moved to the Trusted Certificate.				
Source	PLC Function Module	Source details	OPC UA Server	Detection timing	At successful client certificate move
Error attributes	Level	Information		Log category	Access* ¹
	Recovery	---			
Effects	User program	Continues.	Operation	Not affected.	
System-defined variables	Variable	Data type		Name	
	None	---		---	
Cause and correction	Assumed cause	Correction		Prevention	
	A client certificate was moved to the Trusted Certificate.	None		None	
Attached information	Attached information 1: The thumbprint of the moved client certificate				
Precautions/Remarks	None				
User name in the access log	When the user authentication function is enabled: User name When the user authentication function is disabled: NULL				

*1. This applies to the following CPU Unit only. This is System for other CPU Units.

- NJ-series, NX102, NX1P2 CPU Unit: Version 1.49 or later
- NX502 CPU Unit: Version 1.60 or later
- NX701 CPU Unit: Version 1.29 or later

Event name	Client Certificate Revocation List Added		Event code	95D90000 hex	
Meaning	The client certificate revocation list was added.				
Source	PLC Function Module	Source details	OPC UA Server	Detection timing	At successful client certificate revocation list addition
Error attributes	Level	Information		Log category	Access* ¹
	Recovery	---			
Effects	User program	Continues.	Operation	Not affected.	
System-defined variables	Variable	Data type		Name	
	None	---		---	
Cause and correction	Assumed cause	Correction		Prevention	
	The client certificate revocation list was added.	None		None	
Attached information	Attached information 1: The file name of the added client certificate revocation list				
Precautions/Remarks	None				
User name in the access log	When the user authentication function is enabled: User name When the user authentication function is disabled: NULL				

*1. This applies to the following CPU Unit only. This is System for other CPU Units.

- NJ-series, NX102, NX1P2 CPU Unit: Version 1.49 or later
- NX502 CPU Unit: Version 1.60 or later
- NX701 CPU Unit: Version 1.29 or later

Event name	Client Certificate Revocation List Deleted		Event code	95DA0000 hex	
Meaning	The client certificate revocation list was deleted.				
Source	PLC Function Module	Source details	OPC UA Server	Detection timing	At successful client certificate revocation list deletion
Error attributes	Level	Information		Log category	Access ^{*1}
	Recovery	---			
Effects	User program	Continues.	Operation	Not affected.	
System-defined variables	Variable	Data type		Name	
	None	---		---	
Cause and correction	Assumed cause	Correction		Prevention	
	The client certificate revocation list was deleted.	None		None	
Attached information	Attached information 1: The file name of the deleted client certificate revocation list				
Precautions/Remarks	None				
User name in the access log	When the user authentication function is enabled: User name When the user authentication function is disabled: NULL				

*1. This applies to the following CPU Unit only. This is System for other CPU Units.

- NJ-series, NX102, NX1P2 CPU Unit: Version 1.49 or later
- NX502 CPU Unit: Version 1.60 or later
- NX701 CPU Unit: Version 1.29 or later

Event name	Server Certificate Regenerated		Event code	95DB0000 hex*1	
Meaning	The server certificate was regenerated. <ul style="list-style-type: none"> The server private key and server certificate are automatically generated when Regenerate certificate is performed. 				
Source	PLC Function Module	Source details	OPC UA Server	Detection timing	When server certificate is re-generated
Error attributes	Level	Information		Log category	Access
	Recovery	---			
Effects	User program	Continues.	Operation	Not affected.	
System-defined variables	Variable	Data type		Name	
	None	---		---	
Cause and correction	Assumed cause	Correction		Prevention	
	The server certificate was regenerated.	None		None	
Attached information	Attached information 1: Connection method <ul style="list-style-type: none"> 1: Direct connection via USB 2: Direct connection via Ethernet 3: Remote Connection via USB or Ethernet connection via a hub Attached information 2: When attached information 1 is 2 or 3, the connection source IP address is given. When connection is made through proxy, proxy IP address is given.				
Precautions/Remarks	None				
User name in the access log	When the user authentication function is enabled: User name When the user authentication function is disabled: NULL				

*1. This event code occurs for the following CPU Units.

- NJ-series, NX102, NX1P2 CPU Unit: Version 1.49 or later
- NX502 CPU Unit: Version 1.60 or later
- NX701 CPU Unit: Version 1.29 or later

Event name	Security Settings Transferred		Event code	96200000 hex	
Meaning	The security settings were transferred.				
Source	PLC Function Module	Source details	OPC UA Server	Detection timing	At successful security settings transfer
Error attributes	Level	Information		Log category	Access ^{*1}
	Recovery	---			
Effects	User program	Continues.	Operation	Not affected.	
System-defined variables	Variable	Data type		Name	
	None	---		---	
Cause and correction	Assumed cause	Correction		Prevention	
	The security settings were transferred.	None		None	
Attached information	Attached information 1: Connection method ^{*2} <ul style="list-style-type: none"> • 1: Direct connection via USB • 2: Direct connection via Ethernet • 3: Remote Connection via USB or Ethernet connection via a hub Attached information 2: When attached information 1 is 2 or 3, the connection source IP address is given. When connection is made through proxy, proxy IP address is given. ^{*2}				
Precautions/Remarks	None				
User name in the access log	When the user authentication function is enabled: User name				
	When the user authentication function is disabled: NULL				

*1. This applies to the following CPU Unit only. This is System for other CPU Units.

- NJ-series, NX102, NX1P2 CPU Unit: Version 1.49 or later
- NX502 CPU Unit: Version 1.60 or later
- NX701 CPU Unit: Version 1.29 or later

*2. This applies to the following CPU Unit only. No attached information is given for other CPU Units.

- NJ-series, NX102, NX1P2 CPU Unit: Version 1.49 or later
- NX502 CPU Unit: Version 1.60 or later
- NX701 CPU Unit: Version 1.29 or later

Event name	Execution Log Cleared		Event code	96210000 hex	
Meaning	The Execution Log was cleared.				
Source	PLC Function Module	Source details	OPC UA Server	Detection timing	At successful Execution Log clear
Error attributes	Level	Information		Log category	Access ^{*1}
	Recovery	---			
Effects	User program	Continues.	Operation	Not affected.	
System-defined variables	Variable	Data type		Name	
	None	---		---	
Cause and correction	Assumed cause	Correction		Prevention	
	The Execution Log was cleared.	None		None	
Attached information	<p>Attached information 1: Connection method^{*2}</p> <ul style="list-style-type: none"> • 1: Direct connection via USB • 2: Direct connection via Ethernet • 3: Remote Connection via USB or Ethernet connection via a hub <p>Attached information 2: When attached information 1 is 2 or 3, the connection source IP address is given. When connection is made through proxy, proxy IP address is given.^{*2}</p>				
Precautions/Remarks	None				
User name in the access log	<p>When the user authentication function is enabled: User name</p> <p>When the user authentication function is disabled: NULL</p>				

*1. This applies to the following CPU Unit only. This is System for other CPU Units.

- NJ-series, NX102, NX1P2 CPU Unit: Version 1.49 or later
- NX502 CPU Unit: Version 1.60 or later
- NX701 CPU Unit: Version 1.29 or later

*2. This applies to the following CPU Unit only. No attached information is given for other CPU Units.

- NJ-series, NX102, NX1P2 CPU Unit: Version 1.49 or later
- NX502 CPU Unit: Version 1.60 or later
- NX701 CPU Unit: Version 1.29 or later

Event name	CA Certificate Added			Event code	96220000 hex
Meaning	A CA certificate was added.				
Source	PLC Function Module	Source details	OPC UA Server	Detection timing	At successful CA certificate addition
Error attributes	Level	Information		Log category	Access ^{*1}
	Recovery	---			
Effects	User program	Continues.	Operation	Not affected.	
System-defined variables	Variable	Data type		Name	
	None	---		---	
Cause and correction	Assumed cause		Correction		Prevention
	A CA certificate was added.		None		None
Attached information	Attached information 1: The thumbprint of the added CA certificate				
Precautions/Remarks	None				
User name in the access log	When the user authentication function is enabled: User name				
	When the user authentication function is disabled: NULL				

*1. This applies to the following CPU Unit only. This is System for other CPU Units.

- NJ-series, NX102, NX1P2 CPU Unit: Version 1.49 or later
- NX502 CPU Unit: Version 1.60 or later
- NX701 CPU Unit: Version 1.29 or later

Event name	CA Certificate Deleted			Event code	96230000 hex
Meaning	A CA certificate was deleted.				
Source	PLC Function Module	Source details	OPC UA Server	Detection timing	At successful CA certificate deletion
Error attributes	Level	Information		Log category	Access ^{*1}
	Recovery	---			
Effects	User program	Continues.	Operation	Not affected.	
System-defined variables	Variable	Data type		Name	
	None	---		---	
Cause and correction	Assumed cause		Correction		Prevention
	A CA certificate was deleted.		None		None
Attached information	Attached information 1: The thumbprint of the deleted CA certificate				
Precautions/Remarks	None				
User name in the access log	When the user authentication function is enabled: User name				
	When the user authentication function is disabled: NULL				

*1. This applies to the following CPU Unit only. This is System for other CPU Units.

- NJ-series, NX102, NX1P2 CPU Unit: Version 1.49 or later
- NX502 CPU Unit: Version 1.60 or later
- NX701 CPU Unit: Version 1.29 or later

Event name	CA Certificate Revocation List Added		Event code	96240000 hex	
Meaning	The CA certificate revocation list was added.				
Source	PLC Function Module	Source details	OPC UA Serv- er	Detection timing	At successful CA certificate revocation list addition
Error attributes	Level	Information		Log category	Access* ¹
	Recovery	---			
Effects	User program	Continues.	Operation	Not affected.	
System-defined variables	Variable	Data type		Name	
	None	---		---	
Cause and correction	Assumed cause	Correction		Prevention	
	The CA certificate revocation list was added.	None		None	
Attached information	Attached information 1: The file name of the added CA certificate revocation list				
Precautions/Remarks	None				
User name in the access log	When the user authentication function is enabled: User name When the user authentication function is disabled: NULL				

*1. This applies to the following CPU Unit only. This is System for other CPU Units.

- NJ-series, NX102, NX1P2 CPU Unit: Version 1.49 or later
- NX502 CPU Unit: Version 1.60 or later
- NX701 CPU Unit: Version 1.29 or later

Event name	CA Certificate Revocation List Deleted		Event code	96250000 hex	
Meaning	The CA certificate revocation list was deleted.				
Source	PLC Function Module		Source details	OPC UA Server	Detection timing
Error attributes	Level	Information		Log category	Access ^{*1}
	Recovery	---			
Effects	User program	Continues.	Operation	Not affected.	
System-defined variables	Variable	Data type		Name	
	None	---		---	
Cause and correction	Assumed cause		Correction		Prevention
	The CA certificate revocation list was deleted.		None		None
Attached information	Attached information 1: The file name of the deleted CA certificate revocation list				
Precautions/Remarks	None				
User name in the access log	When the user authentication function is enabled: User name				
	When the user authentication function is disabled: NULL				

*1. This applies to the following CPU Unit only. This is System for other CPU Units.

- NJ-series, NX102, NX1P2 CPU Unit: Version 1.49 or later
- NX502 CPU Unit: Version 1.60 or later
- NX701 CPU Unit: Version 1.29 or later

Event name	Client Certificate or CA Certificate Changed		Event code	96260000 hex ^{*1}	
Meaning	One of the following changes to the certificate has been made. <ul style="list-style-type: none"> • The client certificate was added, deleted, or moved. • The client certificate revocation list was added or deleted. • The CA certificate was added, deleted, or moved. • The CA certificate revocation list was added or deleted. 				
Source	PLC Function Module	Source details	OPC UA Server	Detection timing	When one of the following changes to the certificate is made <ul style="list-style-type: none"> • The client certificate was added, deleted, or moved. • The client certificate revocation list was added or deleted. • The CA certificate was added, deleted, or moved. • The CA certificate revocation list was added or deleted.
Error attributes	Level	Information		Log category	Access
	Recovery	---			
Effects	User program	Continues.	Operation	Not affected.	
System-defined variables	Variable	Data type		Name	
	None	---		---	
Cause and correction	Assumed cause	Correction		Prevention	
	One of the following changes to the certificate has been made. <ul style="list-style-type: none"> • The client certificate was added, deleted, or moved. • The client certificate revocation list was added or deleted. • The CA certificate was added, deleted, or moved. • The CA certificate revocation list was added or deleted. 	None		None	

Attached information	Attached information 1: Connection method <ul style="list-style-type: none"> • 1: Direct connection via USB • 2: Direct connection via Ethernet • 3: Remote Connection via USB or Ethernet connection via a hub Attached information 2: When attached information 1 is 2 or 3, the connection source IP address is given. When connection is made through proxy, proxy IP address is given.
Precautions/Remarks	None
User name in the access log	When the user authentication function is enabled: User name When the user authentication function is disabled: NULL

- *1. This event code occurs for the following CPU Units.
- NJ-series, NX102, NX1P2 CPU Unit: Version 1.49 or later
 - NX502 CPU Unit: Version 1.60 or later
 - NX701 CPU Unit: Version 1.29 or later

OPC UA Instructions

This section provides a table of errors (events) that occur for the following instruction. The lower four digits of the event code give the error code for the instruction.

OPC UA instruction	Name
OPCUA_Shutdown	Shutdown OPC UA Server

Event name	OPC UA Server Shutdown or Shutting Down		Event code	54015000 hex	
Meaning	The OPC UA Server was already shut down or was being shut down.				
Source	PLC Function Module	Source details	OPC UA Server	Detection timing	At instruction execution
Error attributes	Level	Observation		Log category	System
	Recovery	---			
Effects	User program	Continues	Operation	The relevant instruction will end according to specifications.	
System-defined variables	Variable	None		Data type	---
Cause and correction	Assumed cause	Correction		Prevention	
	<ul style="list-style-type: none"> The OPCUA_Shutdown (Shutdown OPC UA Function) instruction was executed while the OPC UA Server was already shut down. The OPCUA_Shutdown (Shutdown OPC UA Function) instruction was executed while the OPC UA Server was being shut down. 	Cycle the power supply to the Controller and start the OPC UA Server before executing the relevant instruction.		When you write the user program, make sure that an OPCUA_Shutdown (Shutdown OPC UA Function) instruction cannot be repeated after the same instruction is executed, or that the shutdown instruction cannot be executed after the same instruction is performed from the Sysmac Studio.	
Attached information	Attached Information 1: Error Location Attached Information 2: Error Location Details (Rung Number). For a program section, the rung number from the start of the section is given. For ST, the line number is given. Attached Information 3: Names of the Instruction and Instruction Instance Where the Error Occurred. If there is more than one possible instruction, information is given on all of them. Nothing is given if the instruction cannot be identified.				
Precautions/Remarks	If a program is changed after an error occurs, the attached information may not be correctly displayed.				

Event name	OPC UA Server Being Initialized		Event code	54015001 hex	
Meaning	The OPCUA_Shutdown (Shutdown OPC UA Function) instruction could not be executed because the OPC UA Server was being initialized.				
Source	PLC Function Module	Source details	OPC UA Server	Detection timing	At instruction execution
Error attributes	Level	Observation		Log category	System
	Recovery	---			
Effects	User program	Continues	Operation	The relevant instruction will end according to specifications.	
System-defined variables	Variable	Data type		Name	
	None	---		---	
Cause and correction	Assumed cause	Correction		Prevention	
	The OPCUA_Shutdown (Shutdown OPC UA Function) instruction was executed while the OPC UA Server was being initialized.	Execute the relevant instruction again.		Execute the relevant instruction again.	
Attached information	<p>Attached Information 1: Error Location</p> <p>Attached Information 2: Error Location Details (Rung Number). For a program section, the rung number from the start of the section is given. For ST, the line number is given.</p> <p>Attached Information 3: Names of the Instruction and Instruction Instance Where the Error Occurred. If there is more than one possible instruction, information is given on all of them. Nothing is given if the instruction cannot be identified.</p> <p>Attached information 4: Expansion Error Code (ErrorIDEx) is given for instructions that have Expansion Error Codes (ErrorIDEx). 0x00000000 is given for instructions that do not have Expansion Error Codes (ErrorIDEx).</p>				
Precautions/Remarks	If a program is changed after an error occurs, the attached information may not be correctly displayed.				

Event name	OPC UA Server Not Started		Event code	54015002 hex	
Meaning	The relevant instruction could not be executed because the OPC UA Server had not been started.				
Source	PLC Function Module	Source details	OPC UA Server	Detection timing	At instruction execution
Error attributes	Level	Observation		Log category	System
	Recovery	---			
Effects	User program	Continues	Operation	The relevant instruction will end according to specifications.	
System-defined variables	Variable	Data type		Name	
	None	---		---	
Cause and correction	Assumed cause	Correction		Prevention	
	When the OPC UA Server Use Option is set to Do not use, the relevant instruction was executed.	Set the OPC UA Server Use Option to Use and cycle the power supply to the Controller before executing the relevant instruction.		Set the OPC UA Server Use Option to Use and cycle the power supply to the Controller before executing the relevant instruction.	
Attached information	<p>Attached Information 1: Error Location</p> <p>Attached Information 2: Error Location Details (Rung Number). For a program section, the rung number from the start of the section is given. For ST, the line number is given.</p> <p>Attached Information 3: Names of the Instruction and Instruction Instance Where the Error Occurred. If there is more than one possible instruction, information is given on all of them. Nothing is given if the instruction cannot be identified.</p> <p>Attached information 4: Expansion Error Code (ErrorIDEx) is given for instructions that have Expansion Error Codes (ErrorIDEx). 0x00000000 is given for instructions that do not have Expansion Error Codes (ErrorIDEx).</p>				
Precautions/Remarks	If a program is changed after an error occurs, the attached information may not be correctly displayed.				

3-9-3 OPC UA Server-specific Troubleshooting

This section shows the problems, causes, corrections, related event logs, and Execution Logs for OPC UA server-specific troubleshooting.

Symptom	Cause 1	Cause 2	Correction	Related logs	
				Event log	Execution Log (Category, log code, and log name)
Cannot connect	The connection destination is incorrect.	The IP address is different.	Specify the same value as set for OPC UA Server Settings - End point for the URL.	---	---
	The connection destination is incorrect.	The IP address has been changed by BOOTP.	Specify the same value as set for OPC UA Server Settings - End point for the URL.	Server Certificate Mismatch (15020000 hex)	Server Certificate Mismatch (CERT, 0004, Mismatch_Host)
	The connection destination is incorrect.	The port number is different or is duplicated with that of another communications service.	Specify the same value as set for OPC UA Server Settings - End point for the URL.	---	---
	The connection destination is incorrect.	The IP address has been changed by the Sysmac Studio, NetworkConfigurator, or instruction.	Change the connection setting of the OPC UA client with a correct IP address. Manually regenerate the server certificate in Sysmac Studio. Then, export the server certificate and import it into OPC UA client.	Server Certificate Mismatch (15020000 hex)	Server Certificate Mismatch (CERT, 0004, Mismatch_Host)
	The Ethernet/IP cable is not connected.	The cable is disconnected. A relay device is faulty, etc.	Check the network environment.	---	---
	OPC UA server setting error	The OPC UA server settings are corrupted.	Execute downloading using the Sysmac Studio.	OPC UA Server Setting Error (35D00000 hex)	OPC UA Server Error (SERVER, 0007, HaltError)
	The OPC UA Server Use setting is incorrect.	OPC UA Server of OPC UA Server Settings is set to <i>Do not use</i> .	Set OPC UA Server to <i>Use</i> .	---	---

Symptom	Cause 1	Cause 2	Correction	Related logs	
				Event log	Execution Log (Category, log code, and log name)
	The OPC UA Server Use setting is incorrect.	The project is downloaded from a CPU Unit with an old version.	Replace the CPU Unit with one which supports OPC UA functionality and then transfer the project to the Controller.	---	---
	Packet Filter setting error	The Use Option for Packet Filter is selected in the TCP/IP Settings View and OPC UA packets are not allowed. Select Controller Setup - Built-in EtherNet/IP Port Settings for this setting.	Enter the settings for Packet Filter to allow OPC UA packets. For the details on the settings, refer to <i>Packet Filter</i> in the <i>NJ/NX-series CPU Unit Built-in EtherNet/IP Port User's Manual (Cat. No. W506)</i> .	---	---
	The OPC UA Server is in the shutdown state.	The OPCUA_Shutdown (Shutdown OPC UA Function) instruction was issued and then the OPC UA server was shut down from the Sysmac Studio.	Cycle the power supply to the Controller, or reset the Controller.	OPC UA Server Stopped (95D10000 hex)	OPC UA Server Shutdown (SERVER, 0006, Shutdown)
	The OPC UA Server is in the Preparing state.	The OPC UA function is being used during downloading, clearing all memory, or restoring.	Wait until the state of the OPC UA function becomes Running and then connect.	---	---
	The client certificate is invalid.	The client certificate or CA certificate is not registered in the Trusted Certificate List for client authentication.	Add the client certificate to the Trusted Certificate List. Add the CA certificate to the Trusted Certificate Lists for client authentication. Add the revoked certificate to the Certificate Revocation Lists for client authentication.	Client Connection Rejected (85600000 hex)	Application Authentication (AUTH, 0001, Application)
	The client certificate is invalid.	The client certificate is corrupted.	Set the correct client certificate for the OPC UA client.	Client Connection Rejected (85600000 hex)	Application Authentication (AUTH, 0001, Application)

Symptom	Cause 1	Cause 2	Correction	Related logs	
				Event log	Execution Log (Category, log code, and log name)
The client certificate is invalid.	The client certificate is not registered in the Trusted Certificate List for client authentication. Or the CA certificate is not registered in the Trusted Certificate List for client authentication or the Trusted Certificate List for issuer authentication.	The client certificate is not registered in the Trusted Certificate List for client authentication. Or the CA certificate is not registered in the Trusted Certificate List for client authentication or the Trusted Certificate List for issuer authentication.	Add the client certificate to the Trusted Certificate List for client authentication. Or add the CA certificate to the Trusted Certificate List for client authentication or the Trusted Certificate List for issuer authentication.	Client Connection Rejected (85600000 hex)	Application Authentication (AUTH, 0001, Application)
The CA-signed client certificate has been revoked.	The CA-signed client certificate has been revoked.	The CA-signed client certificate has been revoked.	Update all CA certificate revocation lists up to the root certificate.	Client Connection Rejected (85600000 hex)	Application Authentication (AUTH, 0001, Application)
The CA certificate has been revoked	The CA certificate itself or the CA certificates up to the root have been revoked.	The CA certificate itself or the CA certificates up to the root have been revoked.	Update all CA certificate revocation lists up to the root certificate.	Client Connection Rejected (85600000 hex)	Application Authentication (AUTH, 0001, Application)
The server certificate is invalid.	The IP address specified in the server certificate does not match the IP address of the Controller.	The IP address specified in the server certificate does not match the IP address of the Controller.	Regenerate the server certificate and install it on the OPC UA client.	Server Certificate Mismatch (15020000 hex)	Server Certificate Mismatch (CERT, 0004, Mismatch_Host)
The server certificate is invalid.	The server certificate has expired.	The server certificate has expired.	Set an appropriate server certificate expiration date and then regenerate the server certificate.	Server Certificate Expired (35D10000 hex)	Server Certificate Expired (CERT, 0003, Expired_Server)
Anonymous login setting mismatch	The anonymous login setting on the OPC UA client does not match the anonymous login setting on the server.	The anonymous login setting on the OPC UA client does not match the anonymous login setting on the server.	Check the consistency of the anonymous login settings between the server and client.	---	---

Symptom	Cause 1	Cause 2	Correction	Related logs	
				Event log	Execution Log (Category, log code, and log name)
Security policy mismatch		The security policy set on the OPC UA client is outside of the allowable range of the server security policy.	Check the consistency of the security policies between the server and client. Add the security policy supported by OPC UA client to the security policy settings of the server.	---	---
Security policy mismatch		The OPC UA client does not support the encryption method of the server certificate.	Check the consistency of the security policies between the server and client.	---	---
Self-signed certificate acceptance rejected		The OPC UA client does not accept the self-signed certificate of the OPC UA server.	Consult with the system administrator to make sure that the self-signed certificate is accepted.	---	---
Server certificate mismatch		The OPC UA server certificate was cleared when all memory was cleared.	Reinstall the server certificate on the OPC UA client.	OPC UA Server Certificate and OPC UA Security Profile Deleted (95D40000 hex)	Server Certificate Updated (CERT, 0001, Update_Seiver)
Server certificate mismatch		The server certificate has been regenerated.	Reinstall the server certificate on the OPC UA client.	---	Server Certificate Updated (CERT, 0001, Update_Seiver)
Error occurs when a session is created.		The number of supported sessions is exceeded.	Make sure that more than five sessions are not created.	---	Application Authentication (AUTH, 0001, Application)
Error occurs when a session is created.		The specified data encoding method is not supported by the OPC UA server.	Set Data Encoding of the OPC UA client to UA Binary.	---	---
Error occurs when a session is created.		The specified transport protocol is not supported by the OPC UA server.	Set Transport Protocol of the OPC UA client to UA TCP.	---	---

Symptom	Cause 1	Cause 2	Correction	Related logs	
				Event log	Execution Log (Category, log code, and log name)
Error occurs when a session is created.	The user name or password entered on the OPC UA client does not match the corresponding authentication setting on the server.	The user name or password entered on the OPC UA client does not match the corresponding authentication setting on the server.	Check the consistency of the user name and password between the server and client.	OPC UA Client Connection Rejected (85600000 hex)	User Authentication (AUTH, 0002, User)
Error occurs when a session is created.	The user of the OPC UA client is not registered in the user authentication settings.	The user of the OPC UA client is not registered in the user authentication settings.	Set the user authentication settings correctly.	OPC UA Client Connection Rejected (85600000 hex)	User Authentication (AUTH, 0002, User)
Error occurs when a session is created.	The user authentication settings have been changed.	The user authentication settings have been changed.	Set the user authentication settings correctly.	OPC UA Client Connection Rejected (85600000 hex)	Security Settings Updated (AUTH, 0100, Update)
Error occurs when a session is created.	The OPC UA client is requesting authentication with user certificate.	The OPC UA client is requesting authentication with user certificate.	Select the Permit Option for Anonymous login in the Security Settings Dialog Box for the OPC UA Server. Or connect with the OPC UA client settings configured for user name and password authentication.	OPC UA Client Connection Rejected (85600000 hex)	Application Authentication (AUTH, 0001, Application)
Error occurs when a session is created.	The settings of the OPC UA server are set for user name and password authentication but the OPC UA client is requesting to connect anonymously.	The settings of the OPC UA server are set for user name and password authentication but the OPC UA client is requesting to connect anonymously.	Select the Permit Option for Anonymous login in the Security Settings Dialog Box for the OPC UA Server. Or connect with the OPC UA client settings configured for user name and password authentication.	OPC UA Client Connection Rejected (85600000 hex)	User Authentication (AUTH, 0002, User)

Symptom	Cause 1	Cause 2	Correction	Related logs	
				Event log	Execution Log (Category, log code, and log name)
	The client certificate cannot be moved to the Trusted Certificate List.	The maximum number of client certificates is already registered in the Trusted Certificate List.	More than 32 client certificates cannot be registered in the Trusted Certificate List. Delete the client certificate of a client that is not connected and then add the client certificate to the Trusted Certificate List.	---	---
	The client certificate cannot be moved as it is not included in the Rejected Certificate List.	The maximum number of client certificates is already registered in the Rejected Certificate List.	More than 32 client certificates cannot be registered in the Rejected Certificate List. Delete unnecessary client certificates from the Rejected Certificate List to reconnect from the client. After the client certificate is added to the Rejected Certificate List, move it to the Trusted Certificate List.	Client Certificate Discarded (95D30000 hex)	Certificate Discarded (CERT, 0102, Discard_Client)
A variable cannot be viewed from an OPC UA client.	A global variable of the CPU Unit is not displayed correctly on the OPC UA client.	The publish attribute of the global variable is set to <i>Do not publish</i> .	Set the publish attribute of the global variable of the CPU Unit to <i>Publish Only, Input or Output</i> .	---	---
	A system-defined variable of the CPU Unit is not displayed correctly on the OPC UA client.	---	A system-defined variable cannot be published. Copy it to a network-published variable in a user program.	---	---

Symptom	Cause 1	Cause 2	Correction	Related logs	
				Event log	Execution Log (Category, log code, and log name)
	A global variable of the CPU Unit is not displayed correctly on the OPC UA client.	The variable is a variable that cannot be published.	<p>The following variables cannot be published by the OPC UA Server. Change the variable to a data type that can be published with the OPC UA Server.</p> <ul style="list-style-type: none"> • Multidimensional array specified structure • Structure containing multidimensional array(s) as member(s) • Structure whose nesting number exceeds the limit value • Union • Array whose start number is not 0 • Variable whose size exceeds the limit value • Array whose number of elements exceeds the limit value • Structure whose number of members exceeds the limit value 	Unsupported Data Type (35D40000 hex)	Variable Including Unsupported Data Type (SERVER, 0101, InvalidDataType)
	No node for structure member.	The structure member cannot be deployed.	Refer to the value attributes for details on the members of structure variables.	---	---
	A variable of the CPU Unit is not displayed correctly on the OPC UA client.	The number of variables that can be published is exceeded.	<p>Set the number of public variables of the OPC UA Server to no more than the upper limit.</p> <p>Set the publish attribute of any global variable for which network publishing is not necessary to <i>Do not publish</i>.</p>	Too Many Public Variables (35D30000 hex)	Maximum Number of Variables That Can Be Published Is Exceeded (SERVER, 0100, Max-Variables)

Symptom	Cause 1	Cause 2	Correction	Related logs	
				Event log	Execution Log (Category, log code, and log name)
	A variable of the CPU Unit is not displayed correctly on the OPC UA client.	The maximum number of value attributes that can be published is exceeded.	Make sure that the number of public attributes for the OPC UA Server does not exceed the upper limit. Set the publish attribute of any global variable for which network publishing is not necessary to <i>Do not publish</i> .	Too Many Public Value Attributes (35D50000 hex)	Maximum Number of Variables That Can Be Published Is Exceeded (SERVER, 0100, Max-Variables)
	A variable of the CPU Unit is not displayed correctly on the OPC UA client.	The maximum number of structure definitions that can be published is exceeded.	Make sure that the number of structure definitions that can be published for the OPC UA Server does not exceed the upper limit.	Too Many Structure Definitions (35D60000 hex)	Maximum Number of Variables That Can Be Published Is Exceeded (SERVER, 0100, Max-Variables)

Symptom	Cause 1	Cause 2	Correction	Related logs	
				Event log	Execution Log (Category, log code, and log name)
A variable cannot be read or written.	Read/write error	The variable is not published to OPC UA.	Set the publish attribute of the variable to <i>Publish Only, Input or Output</i> .	---	---
	Read/write error	OPC UA is in a shut-down state.	Cycle the power supply to the Controller, or reset the Controller.	OPC UA Server Stopped (95D10000 hex)	OPC UA Server Shut-down (SERVER, 0006, Shut-down)
	Read/write error	OPC UA is in the Preparing state.	Read/write after the state becomes Running.	---	---
	Read/write error	The variable cannot be accessed because an element in its array is specified.	Specify the entire array.	---	---
	Read/write error	The variable cannot be accessed because its structure member is specified.	Specify the entire structure.	---	---
	Read/write error	The EtherNet/IP cable has become disconnected, communications has been cut off, or other communications failure has occurred.	Check the network environment.	---	Application Authentication (AUTH, 0001, Application)

Symptom	Cause 1	Cause 2	Correction	Related logs	
				Event log	Execution Log (Category, log code, and log name)
The subscription settings cannot be configured.	Subscription error	The maximum value for subscriptions is exceeded.	Make sure that the number of OPC UA subscriptions does not exceed 100.	---	---
	Subscription error	The maximum value for Monitored Item is exceeded.	Make sure that the number of OPC UA client Monitored Items does not exceed 2,000 for NJ501-1□00 and 1,000 for NX102-□□□□.	---	---
	Subscription error	OPC UA is in a shut-down state.	Cycle the power supply to the Controller, or reset the Controller and then execute.	OPC UA Server Stopped (95D10000 hex)	OPC UA Server Shut-down (SERVER, 0006, Shut-down)
	Subscription error	OPC UA is in the Preparing state.	Execute after the state becomes Running.	---	---
	Subscription error	The EtherNet/IP cable has become disconnected, communications has been cut off, or other communications failure has occurred.	Check the network environment.	---	Connection from OPC UA client (AUTH, 0001, Application)

Symptom	Cause 1	Cause 2	Correction	Related logs	
				Event log	Execution Log (Category, log code, and log name)
Execution logs are not recorded.	There is no SD Memory Card installed.	An SD Memory Card is not inserted correctly in the CPU Unit. <ul style="list-style-type: none"> The SD Memory Card is broken. Unsupported SD Memory Card is installed. The SD card is not formatted. 	Insert an SD Memory Card into the CPU Unit correctly.	Execution Log Save Failed (15000000 hex)	---
	SD Memory Card is write-protected.	The SD Memory Card is "write-protected" with the write protection switch.	Change the write protection switch setting of the SD Memory Card to allow writing.	Execution Log Save Failed (15000000 hex)	---
	The settings are incorrect.	The <i>Do not record</i> Option is selected for Execution Log in the OPC UA Server Settings Tab Page.	Select the <i>Record</i> Option for Execution Log in the OPC UA Server Settings Tab Page.	---	---

Refer to *3-9 Errors in the OPC UA Function* on page 3-818 for details on the event logs.

Refer to *NJ/NX-series CPU Unit OPC UA User's Manual (Cat. No. W588)* for details on execution logs.



Appendices

The appendix describes the other errors (events) that can occur in models other than the standard CPU Units, the errors (events) that can occur in connected devices, the events in order of event codes, the applicable range of the HMI Troubleshooter and the correspondence of NX bus events for NX102 CPU Units, NX1P2 CPU Units and Slave Terminals.

A-1	Other Errors (Events) That Can Occur in the CPU Units.....	A-2
A-1-1	Errors in the DB Connection Service Function.....	A-2
A-1-2	Errors in GEM Services.....	A-12
A-1-3	Errors in Robot Control Function.....	A-18
A-1-4	Errors in NJ Robotics Function.....	A-38
A-1-5	Errors in the CNC Function.....	A-58
A-2	Errors (Events) That Can Occur in Connected Devices.....	A-80
A-2-1	Errors in Slave Terminals.....	A-80
A-2-2	Errors in EtherCAT Slaves.....	A-147
A-2-3	Errors in CJ-series Units.....	A-195
A-3	An Error Log Table for CJ-series Special Units.....	A-224
A-4	Events in Order of Event Codes.....	A-230
A-4-1	Interpreting Error Descriptions.....	A-230
A-4-2	Error Table.....	A-232
A-5	Applicable Range of the HMI Troubleshooter.....	A-300
A-5-1	Combinations of HMIs and CPU Units That Enable Using the Troubleshooter.....	A-300
A-5-2	System Configuration Elements Supported by the Troubleshooter.....	A-302
A-6	Correspondence of Events between Project Unit Version Earlier than 1.40 and Project Unit Version 1.40 or Later.....	A-303
A-7	Correspondence of NX Bus Events between NX102 CPU Units, NX1P2 CPU Units and Slave Terminals.....	A-305
A-8	Correction of Wiring for the EtherCAT Ring Topology Based on Event.....	A-306
A-8-1	Flowchart of the Procedure for the Correction of Wiring for the EtherCAT Ring Topology Based on Event.....	A-308
A-8-2	How to Correct the Wiring of Ring Topology Based on Event.....	A-310
A-9	Operation Related to the X Bus Unit.....	A-321
A-9-1	Controller Behavior for Each Level of Error.....	A-321
A-9-2	Operation of the Function Module When It Becomes an Event Source.....	A-321

A-1 Other Errors (Events) That Can Occur in the CPU Units

This appendix provides tables of the errors (events) that can occur in models other than the standard NJ/NX-series CPU Units. These errors are not listed in *Section 3 Error Descriptions and Corrections* on page 3-1. Refer to *3-1 Interpreting Tables* on page 3-3 for interpreting error tables. Refer to the manual for the specific product for details on errors.

A-1-1 Errors in the DB Connection Service Function

The section provides tables of the errors (events) that can occur in the DB connection service or DB connection instructions.

Refer to *NJ/NX-series Database Connection CPU Units User's Manual (Cat. No. W527)* for information on the model and the unit version of the CPU Unit with which you can use the DB connection service and DB connection instructions.

The errors are divided into the following functional groups.

- Database connection service
- Database connection instructions

DB Connection Service

The manual names are given below for the catalog numbers given in the Reference column of the event table.

Cat. No.	Manual name
W527	NJ/NX-series Database Connection CPU Units User's Manual

Event code	Event name	Meaning	Assumed cause	Level					Reference
				M a j	P r t	M i n	O b s	I n f o	
14D00000 hex	Spool Memory Corrupted	Spool Memory Corrupted	<ul style="list-style-type: none"> • The user application made an invalid writing to the Spool memory. • Service start in Run mode in the DB Connection Service Settings was changed from anything other than Do not use to Do not use, and then changed again to anything other than Do not use. 			○			W527

Event code	Event name	Meaning	Assumed cause	Level					Reference
				M a j	P r t	M i n	O b s	I n f o	
14D20000 hex	Execution Log Save Failed	Failed to save the Execution Log to the SD Memory Card.	<ul style="list-style-type: none"> An SD Memory Card is not inserted. The SD Memory Card is not the correct type of card. The format of the SD Memory Card is not correct. The SD Memory Card is write protected. The capacity of the SD Memory Card is insufficient. The SD Memory Card is damaged. 			○	○		W527
14D30000 hex	SQL Execution Failure Log Save Failed	Failed to save the SQL Execution Failure Log to the SD Memory Card.	<ul style="list-style-type: none"> An SD Memory Card is not inserted. The SD Memory Card is not the correct type of card. The format of the SD Memory Card is not correct. The SD Memory Card is write protected. The capacity of the SD Memory Card is insufficient. The SD Memory Card is damaged. 			○	○		W527
35300000 hex	DB Connection Setting Error	The DB Connection settings are not correct.	<ul style="list-style-type: none"> The power supply to the Controller was interrupted during a download of the DB Connection settings. The DB Connection settings are not correct because the power supply to the Controller was interrupted during a Clear All Memory operation. The DB Connection settings are not correct because the power supply to the Controller was interrupted during a Restore operation. Non-volatile memory failed. 			○			W527

Event code	Event name	Meaning	Assumed cause	Level					Reference
				M a j	P r t	M i n	O b s	I n f o	
35310000 hex	DB Server Certificate Error	The format of a DB server certificate is incorrect.	<ul style="list-style-type: none"> The DB server certificate, which must be formatted in the X.509 certificate, was downloaded in an incorrect format. The CPU Unit was powered OFF during a transfer of DB connection settings. The DB connection settings are incorrect because the Controller was powered OFF during Clear All Memory operation. The DB connection settings are incorrect because the Controller was powered OFF during restore operation. Non-volatile memory failure 			○			W527
441C0000 hex	DB Connection Service System Error	A fatal error was detected in DB connection service.	<ul style="list-style-type: none"> A soft error occurred. 			○			W527
85100000 hex	DB Connection Disconnected Error	DB connection was lost abnormally.	<ul style="list-style-type: none"> The server was turned OFF. The DB is stopped in the server. The Ethernet cable connector is disconnected. The Ethernet cable is broken. Noise 			○			W527
95300000 hex	DB Connection Service Started	The DB Connection Service was started.	<ul style="list-style-type: none"> The DB Connection Service was successfully started. 					○	W527
95310000 hex	DB Connection Service Stopped	The DB Connection Service was stopped.	<ul style="list-style-type: none"> The DB Connection Service was stopped. 					○	W527
95320000 hex	DB Connection Service Shutdown	The DB Connection Service was shut down.	<ul style="list-style-type: none"> The DB connection service was ended. 					○	W527
95330000 hex	Spool Cleared	The SQL statements stored in the spool memory were cleared.	<ul style="list-style-type: none"> The SQL statements stored in the spool memory were cleared. 					○	W527
95340000 hex	Operation to Start DB Connection Service	Operation for starting the DB connection service was performed.	<ul style="list-style-type: none"> Operation for starting the DB connection service was performed with the Sysmac Studio. 					○	W527
95350000 hex	Operation to Stop DB Connection Service	Operation for stopping the DB connection service was performed.	<ul style="list-style-type: none"> Operation for stopping the DB connection service was performed with the Sysmac Studio. 					○	W527

Event code	Event name	Meaning	Assumed cause	Level					Reference
				M a j	P r t	M i n	O b s	I n f o	
95360000 hex	Operation to End DB Connection Service	Operation for ending the DB connection service was performed.	<ul style="list-style-type: none"> Operation for ending the DB connection service was performed with the Sysmac Studio. 					○	W527
95370000 hex	Operation to Clear Spool Memory	Operation for clearing the SQL statements stored in the spool memory was performed.	<ul style="list-style-type: none"> Operation for clearing the SQL statements stored in the spool memory was performed with the Sysmac Studio. 					○	W527
95380000 hex	Operation to Clear Operation Log	Operation for clearing the operation log was performed.	<ul style="list-style-type: none"> Operation for clearing the operation log was performed with the Sysmac Studio. 					○	W527
95390000 hex	Operation to Start Debug Logging	Operation for starting debug logging was performed.	<ul style="list-style-type: none"> Operation for starting debug logging was performed with the Sysmac Studio. 					○	W527
953A0000 hex	Operation to Stop Debug Logging	Operation for stopping debug logging was performed.	<ul style="list-style-type: none"> Operation for stopping debug logging was performed with the Sysmac Studio. 					○	W527



DB Connection Instructions

The lower four digits of the event code give the error code (ErrorID) for the instruction. For descriptions of an error code, refer to the description of the corresponding event code. For example, if the error code for the instruction is 16#3000, refer to the description for event code 54013000 hex.

The manual names are given below for the catalog numbers given in the Reference column of the event table.

Cat. No.	Manual name
W527	NJ/NX-series Database Connection CPU Units User's Manual

Event code	Event name	Meaning	Assumed cause	Level					Reference
				M a j	P r t	M i n	O b s	I n f o	
54013000 hex	DB Connection Service Not Started	The DB Connection Service has not been started.	<ul style="list-style-type: none"> A command to start the DB Connection Service was not given before the execution of relevant instruction. A command to stop the DB Connection Service was given before the execution of relevant instruction. 				○		W527
54013001 hex	DB Connection Service Run Mode Change Failed	Failed to change the Run mode of the DB Connection Service.	<ul style="list-style-type: none"> Run mode change to Test Mode was executed by the relevant instruction while running in Operation Mode. Run mode change to Operation Mode was executed by the relevant instruction while running in Test Mode. Start of the DB Connection Service was commanded while the DB Connection Service was being stopped. Shutdown of the DB Connection Service was commanded while the DB Connection Service was being stopped. 				○		W527
54013002 hex	DB Connection Service Shutdown or Shutting Down	The DB Connection Service is already shut down or being shut down.	<ul style="list-style-type: none"> The relevant instruction was executed after the DB Connection Service was shut down. The relevant instruction was executed while the shutdown processing of the DB Connection Service was in progress. 				○		W527

Event code	Event name	Meaning	Assumed cause	Level					Reference
				M a j	P r t	M i n	O b s	I n f o	
54013003 hex	Invalid DB Connection Name	The specified DB Connection Name is not set in any DB Connection settings.	<ul style="list-style-type: none"> The DB Connection Name specified in the <i>DBConnectionName</i> input variable of the relevant instruction is wrong. The DB Connection Name set in the DB Connection settings is wrong. 				○		W527
54013004 hex	DB Connection Rejected	The DB rejected the connection.	<ul style="list-style-type: none"> The user name or password set in the DB Connection settings is wrong. 				○		W527
54013005 hex	DB Connection Failed	Failed to connect to the DB.	<ul style="list-style-type: none"> A server does not exist for the specified IP address or the specified host name. The power supply to the server is OFF. The DB is stopped in the server. The Ethernet cable connector is disconnected. The Ethernet cable is broken. 				○		W527
54013006 hex	DB Connection Already Established	A same-name DB Connection is already established.	<ul style="list-style-type: none"> The relevant instruction was executed when a same-name DB Connection was already established. 				○		W527
54013007 hex	Too Many DB Connections	The number of DB Connections that can be established at the same time is exceeded.	<ul style="list-style-type: none"> The relevant instruction was executed when the maximum number of DB Connections that can be established at the same time were already established. 				○		W527
54013008 hex	Invalid DB Connection	The specified DB Connection is not correct, or the DB Connection is already closed.	<ul style="list-style-type: none"> The DB Connection specified in the <i>DBConnection</i> input variable of the relevant instruction is wrong. The DB Connection specified in the <i>DBConnection</i> input variable of the relevant instruction is closed. 				○		W527
54013009 hex	Invalid DB Map Variable	The specified DB Map Variable is not correct.	<ul style="list-style-type: none"> A structure variable that contains a derivative data type of member was specified as a DB Map Variable. A non-structure variable was specified as a DB Map Variable. A structure array variable was specified as a DB Map Variable for INSERT or UPDATE. 				○		W527

Event code	Event name	Meaning	Assumed cause	Level					Reference
				M a j	P r t	M i n	O b s	I n f o	
5401300A hex	Unregistered DB Map Variable	The specified DB Map Variable has not been registered.	<ul style="list-style-type: none"> The DB Map Variable has not been created by a DB_Create-Mapping instruction. A variable that is not registered as a DB Map Variable was specified in <i>MapVar</i>. The DB Connection specified in the relevant instruction is different from the one specified at the execution of DB_Create-Mapping instruction. 				○		W527
5401300B hex	SQL Execution Error	The executed SQL statement resulted in an error.	<ul style="list-style-type: none"> There is no column with the same name as a structure member of the DB Map Variable. The table specified in the DB_CreateMapping instruction does not exist in the DB. One or more structure member values of the DB Map Variable cannot be converted to the corresponding column's data type. One or more column values cannot be converted to the corresponding structure member's data type of the DB Map Variable. One or more structure member values of the DB Map Variable exceed the valid range of the corresponding column's data type. The column specified in the extraction condition does not exist in the DB's records. (DB_Select instruction, DB_Update instruction, DB_Delete instruction) The extraction condition has a syntax error. (DB_Select instruction, DB_Update instruction, DB_Delete instruction) The column specified in the sort condition does not exist in the DB's records. (DB_Select instruction) The sort condition has a syntax error. (DB_Select instruction) The user does not have the access rights to the table. 				○		W527



Event code	Event name	Meaning	Assumed cause	Level					Reference
				M a j	P r t	M i n	O b s	I n f o	
5401300C hex	Spool Capacity Exceeded	The SQL statement could not be stored in the Spool memory because its maximum capacity was exceeded.	<ul style="list-style-type: none"> The DB connection failure has been continuing due to network failure or other factors. The resend processing of the SQL statements stored in the Spool memory has not been executed (when the Resend spool data parameter is set to Manual). 				○		W527
5401300E hex	Invalid Extraction Condition	The entered extraction condition is invalid.	<ul style="list-style-type: none"> A text string that consists of a NULL (16#00) character only was specified in the <i>Where</i> input variable. 				○		W527
54013010 hex	Log Code Out of Range	The value of the entered log code is outside the valid range.	<ul style="list-style-type: none"> A value outside the valid range from 0 to 9999 was specified. 				○		W527
54013011 hex	DB Connection Disconnected Error Status	The instruction could not be executed because the DB Connection had been disconnected due to an error.	<ul style="list-style-type: none"> The power supply to the server is OFF. The DB is stopped in the server. The Ethernet cable connector is disconnected. The Ethernet cable is broken. Noise 				○		W527
54013012 hex	DB Connection Instruction Execution Timeout	The instruction was not completed within the time specified for instruction execution timeout.	<ul style="list-style-type: none"> The power supply to the server is OFF. The Ethernet cable connector is disconnected. The Ethernet cable is broken. The server's processing time is long. 				○		W527
54013013 hex	DB Connection Service Error Stop	The instruction could not be executed because the DB Connection Service was stopped due to an error.	<ul style="list-style-type: none"> The DB Connection settings are corrupted. 				○		W527
54013014 hex	Data Already Spooled	One or more SQL statements are already stored in the Spool memory.	<ul style="list-style-type: none"> A DB_Insert or DB_Update instruction was executed when one or more SQL statements were already stored in the Spool memory. A DB_Select or DB_Delete instruction was executed when one or more SQL statements were already stored in the Spool memory. 				○		W527

Event code	Event name	Meaning	Assumed cause	Level					Reference
				M a j	P r t	M i n	O b s	I n f o	
54013015 hex	DB Connection Service Initializing	The instruction could not be executed because the initialization processing of the DB Connection Service is in progress.	<ul style="list-style-type: none"> The relevant instruction was executed during the initialization processing of the DB Connection Service. 				○		W527
54013016 hex	DB in Process	The instruction could not be executed because the DB is under processing in the server.	<ul style="list-style-type: none"> Though a DB Connection Instruction Execution Timeout occurred for the previous instruction, the relevant instruction was executed before completion of the DB's processing in the server. 				○		W527
54013017 hex	Operation Log Disabled	The log could not be recorded because the specified Operation Log is disabled.	<ul style="list-style-type: none"> Though Execution Log was specified in the <i>LogType</i> input variable, the Execution Log is disabled. Though Debug Log was specified in the <i>LogType</i> input variable, recording to the Debug Log is stopped. 				○		W527
54013018 hex	Invalid Procedure Handle	The specified procedure handles is invalid.	<ul style="list-style-type: none"> The procedure handle specified in the <i>ProcHandle</i> input variable of the relevant instruction is wrong. 				○		W527
54013019 hex	Instruction Executed for Unsupported Database Type	The instruction was executed for a database type that is not supported by this instruction.	<ul style="list-style-type: none"> The database type specified in DB Connection Settings is not supported by the relevant instruction. 				○		W527
5401301A hex	Invalid Stored Procedure Name	The specified stored procedure name does not exist.	<ul style="list-style-type: none"> The stored procedure name specified in the <i>ProcName</i> input variable of the relevant instruction does not exist in the server-side database. 				○		W527
5401301B hex	Invalid Stored Procedure Argument	The attached argument information does not match the argument of the stored procedure.	<ul style="list-style-type: none"> The name, number, and type of the stored procedure argument data that is retrieved from the server-side database do not match those of the input variables <i>ArgIn</i>, <i>ArgOut</i>, and <i>ArgInOut</i> of the relevant instruction. 				○		W527
5401301C hex	Invalid Number of Columns for Stored Procedure Result Set	The number of columns in the stored procedure result set do not match the number of structure variable members where the result is stored.	<ul style="list-style-type: none"> The number of columns in the result set retrieved by the relevant instruction do not match the number of structure variable members where the result is stored. 				○		W527

A

Event code	Event name	Meaning	Assumed cause	Level					Reference
				M a j	P r t	M i n	O b s	I n f o	
5401301E hex	DB Connection Service Not Used	DB connection service is set to Do not use .	<ul style="list-style-type: none"> The command was executed while DB connection service is set to Do not use. 				○		W527

A-1-2 Errors in GEM Services

The section provides tables of the errors (events) that can occur in the GEM Services and GEM instructions.

You can use the GEM Services and GEM instructions with the NJ501-1340 CPU Unit. The unit version of the CPU Unit is 1.09 or later.

The errors are divided into the following functional groups.

- GEM Services
- GEM instructions

GEM Services

The manual names are given below for the catalog numbers given in the Reference column of the event table.

Cat. No.	Manual name
W528	NJ-series SECS/GEM CPU Units User's Manual

Event code	Event name	Meaning	Assumed cause	Level					Reference
				M a j	P r t	M i n	O b s	I n f o	
14E00000 hex	Invalid GEM Setting Data	The GEM setting data is invalid.	<ul style="list-style-type: none"> • The power supply to the CPU Unit was interrupted during a transfer of the setting data of the GEM Service. • The setting data of the GEM Service is not correct because the power supply to the Controller was interrupted during a Clear All Memory operation. • Non-volatile memory failed. 			○			W528
14E20000 hex	Spool Data Discarded	The spool data is discarded.	<ul style="list-style-type: none"> • The spool data was discarded because the power supply to the CPU Unit was interrupted with no shutdown. 			○			W528
14E30000 hex	Spool Save Failed	Failed to save the spooled data to the SD Memory Card.	<ul style="list-style-type: none"> • The capacity of the SD Memory Card is insufficient. • The SD Memory Card is damaged. 			○			W528
35400000 hex	Illegal Variable Allocation	Resolution of the variable allocation failed.	<ul style="list-style-type: none"> • The variable that is specified in the SECS/GEM Configurator does not exist in the global variables. • The data type, constant attribute, number of array dimensions or number of array elements of the variable that is set in the SECS/GEM Configurator is different from the variable defined in the global variables. 			○			W528

Event code	Event name	Meaning	Assumed cause	Level					Reference
				M a j	P r t	M i n	O b s	I n f o	
35410000 hex	Illegal TCP Port Number	The TCP port number for the host communications is illegal.	<ul style="list-style-type: none"> The TCP port number for the host communications is also used as the TCP port number of another function. 			○			W528
14E10000 hex	GEM Service Log Save Failed	An error occurred when the GEM Service log is written to the SD Memory Card.	<ul style="list-style-type: none"> The capacity of the SD Memory Card is insufficient. The SD Memory Card is damaged. 				○		W528
14E40000 hex	Invalid SD Memory Card	An SD Memory Card is not inserted or an SD Memory Card that cannot be written is inserted.	<ul style="list-style-type: none"> An SD Memory Card is not inserted. The SD Memory Card type is not correct. The format of the SD Memory Card is not correct. The SD Memory Card is write protected. 				○		W528
66000000 hex	Send Transaction Queue Overrun	The send transaction exceeded the capacity for temporary storage.	<ul style="list-style-type: none"> The capacity to process the send transaction is insufficient. 				○		W528
66010000 hex	Reception Transaction Queue Overrun	The reception transaction exceeded the capacity for temporary storage.	<ul style="list-style-type: none"> The capacity to process the reception transaction is insufficient. 				○		W528
66020000 hex	Too Long SECS Message	The SECS message to be sent to the host exceeds the maximum length.	<ul style="list-style-type: none"> The SECS message to be sent to the host exceeds the maximum length. 				○		W528
95420000 hex	GEM Service Started	The GEM Service started normally.	<ul style="list-style-type: none"> The GEM Service started normally. 					○	W528
95430000 hex	Shutdown Completed	The shutdown processing was completed normally.	<ul style="list-style-type: none"> The shutdown processing was completed normally. 					○	W528
95440000 hex	GEM Setting Data Changed	The setting data of the GEM Service was changed.	<ul style="list-style-type: none"> The setting data of the GEM Service from the SECS/GEM Configurator was changed. 					○	W528
95450000 hex	Valid SD Memory Card	An SD Memory Card that can be written is inserted.	<ul style="list-style-type: none"> An SD Memory Card that can be written is inserted. 					○	W528

GEM Instructions

The lower four digits of the event code give the error code (ErrorID) for the instruction. For descriptions of an error code, refer to the description of the corresponding event code. For example, if the error code for the instruction is 16#0400, refer to the description for event code 54010400 hex.

The manual names are given below for the catalog numbers given in the Reference column of the event table.

Cat. No.	Manual name
W502	NJ/NX-series Instructions Reference Manual
W528	NJ-series SECS/GEM CPU Units User's Manual

Event code	Event name	Meaning	Assumed cause	Level					Reference
				M a j	P r t	M i n	O b s	I n f o	
54010400 hex	Input Value Out of Range	An input parameter for an instruction exceeded the valid range for an input variable. Or, division by an integer of 0 occurred in division or remainder calculations.	<ul style="list-style-type: none"> An input parameter for an instruction exceeded the valid range for an input variable. Or, division by an integer of 0 occurred in division or remainder calculations. 					○	W502
54010419 hex	Incorrect Data Type	A data type that cannot be used for an instruction is specified for an input or in-out variable.	<ul style="list-style-type: none"> A data type that cannot be used for an instruction is specified for an input or in-out variable. 					○	W502
5401041D hex	Exceeded Simultaneous Instruction Executed Resources	The maximum resources that you can use for the relevant instruction group at the same time was exceeded.	<ul style="list-style-type: none"> More than the maximum number of relevant instructions were executed at the same time. 					○	W502
54013810 hex	GEM Service Status in Initializing	An instruction was executed when the GEM Service status was Initializing.	<ul style="list-style-type: none"> The relevant instruction was executed when the GEM Service status was Initializing. 					○	W528
54013811 hex	GEM Service Status in EQStarting	An instruction was executed when the GEM Service status was EQStarting.	<ul style="list-style-type: none"> The relevant instruction was executed when the GEM Service status was EQStarting. 					○	W528
54013812 hex	GEM Service Status in EQInitializing	An instruction was executed when the GEM Service status was EQInitializing.	<ul style="list-style-type: none"> The relevant instruction was executed when the GEM Service status was EQInitializing. 					○	W528
54013813 hex	GEM Service Status in EQRun	An instruction was executed when the GEM Service status was EQRun.	<ul style="list-style-type: none"> The relevant instruction was executed when the GEM Service status was EQRun. 					○	W528



Event code	Event name	Meaning	Assumed cause	Level					Reference
				M a j	P r t	M i n	O b s	I n f o	
54013814 hex	GEM Service Status in Stop	An instruction was executed when the GEM Service status was Stop.	<ul style="list-style-type: none"> The relevant instruction was executed when the GEM Service status was Stop. 				○		W528
54013815 hex	GEM Service Status in Error	An instruction was executed when the GEM Service status was Error.	<ul style="list-style-type: none"> The relevant instruction was executed when the GEM Service status was Error. 				○		W528
54013816 hex	GEM Service Status in Shutting-Down	An instruction was executed when the GEM Service status was ShuttingDown.	<ul style="list-style-type: none"> The relevant instruction was executed when the GEM Service status was ShuttingDown. 				○		W528
54013817 hex	GEM Service Status in Shutdown	An instruction was executed when the GEM Service status was Shutdown.	<ul style="list-style-type: none"> The relevant instruction was executed when the GEM Service status was Shutdown. 				○		W528
54013818 hex	No Message Received	An instruction was executed without receiving a SECS message from the host.	<ul style="list-style-type: none"> The relevant instruction was executed without receiving the relevant SECS message from the host. 				○		W528
54013819 hex	Multi-execution of Instructions	Processing of a transaction for a different instance of the same instruction that was executed before this instruction is not completed.	<ul style="list-style-type: none"> This instruction was executed before completing processing for a transaction for a different instance of the same instruction. 				○		W528
5401381A hex	State Transition in Progress	A state transition for a different instance of the same instruction that was executed before this instruction is not completed.	<ul style="list-style-type: none"> This instruction was executed for a different instance of the GEM_ChangeCommState instruction in <i>EnabledNotComm</i> state. This instruction was executed for a different instance of the GEM_ChangeControlState instruction in <i>AttemptOnline</i> state. 				○		W528
5401381B hex	Insufficient Transaction Resource	The instruction was executed while the number of transactions that can be buffered exceeds the upper limit.	<ul style="list-style-type: none"> The instruction was executed while the number of transactions that can be buffered exceeds the upper limit. 				○		W528
54013820 hex	Too Many Characters	More characters were specified than the number that was set and the instruction was executed.	<ul style="list-style-type: none"> More characters were specified than the number of characters set with the SECS/GEM Configurator. 				○		W528

Event code	Event name	Meaning	Assumed cause	Level					Reference
				M a j	P r t	M i n	O b s	I n f o	
54013821 hex	Invalid Size	An incorrect array or an array with an incorrect number of elements was specified and the instruction was executed.	<ul style="list-style-type: none"> A value was specified that is larger than the maximum table size set with the SECS/GEM Configurator. 				○		W528
54013822 hex	Set to Disable	The instruction that was set to disable was executed.	<ul style="list-style-type: none"> The instruction executed for a GEM capability was disabled on the SECS/GEM Configurator. 				○		W528
54013824 hex	Undefined CEID	An undefined CEID was specified and the instruction was executed.	<ul style="list-style-type: none"> A CEID that was not defined in the SECS/GEM Configurator was specified. 				○		W528
54013825 hex	Undefined ALID	An undefined ALID was specified and the instruction was executed.	<ul style="list-style-type: none"> An ALID that was not defined in the SECS/GEM Configurator was specified. 				○		W528
54013826 hex	Undefined CCODE	An undefined CCODE was specified and the instruction was executed.	<ul style="list-style-type: none"> A CCODE that was not defined in the SECS/GEM Configurator was specified. 				○		W528
54013827 hex	Undefined Message Number	An undefined message number was specified and the instruction was executed.	<ul style="list-style-type: none"> A message number that was not defined in the SECS/GEM Configurator was specified. 				○		W528
54013828 hex	HSMS Communications Setting Out of Range	An HSMS communications setting that is out of range was specified and the instruction was executed.	<ul style="list-style-type: none"> An HSMS communications setting that is out of range was specified. 				○		W528
54013829 hex	TID Out of Range	A TID that is out of range was specified and the instruction was executed.	<ul style="list-style-type: none"> A TID that is out of range was specified. 				○		W528
5401382C hex	Undefined ECID	An undefined ECID was specified and the instruction was executed.	<ul style="list-style-type: none"> An ECID that was not defined in the SECS/GEM Configurator was specified. 				○		W528
5401382D hex	Type Mismatch	A value with an incorrect data type was specified and the instruction was executed.	<ul style="list-style-type: none"> A different equipment constant data type than the one registered with the SECS/GEM Configurator was specified. 				○		W528
5401382E hex	ECV Out of Range	An out-of-range value was specified for an equipment constant and the instruction was executed.	<ul style="list-style-type: none"> A value was specified that is outside the upper and lower limits of the value of the equipment constant that was set on the SECS/GEM Configurator. 				○		W528

A

Event code	Event name	Meaning	Assumed cause	Level					Reference
				M a j	P r t	M i n	O b s	I n f o	
5401382F hex	Illegal CPNAME	A CPNAME that is different from the received CPNAME was specified and the instruction was executed.	<ul style="list-style-type: none"> A CPNAME was specified that is different from the received CPNAME. 				○		W528
54013830 hex	HACK Out of Range	An HACK that is out of range was specified and the instruction was executed.	<ul style="list-style-type: none"> An HACK that is out of range was specified. 				○		W528
54013831 hex	CPACK Out of Range	A CPACK that is out of range was specified and the instruction was executed.	<ul style="list-style-type: none"> A CPACK that is out of range was specified. 				○		W528
54013832 hex	CEPACK Out of Range	A CEPACK that is out of range was specified and the instruction was executed.	<ul style="list-style-type: none"> A CEPACK that is out of range was specified. 				○		W528
54013833 hex	ACKC7 Out of Range	An ACKC7 that is out of range was specified and the instruction was executed.	<ul style="list-style-type: none"> An ACKC7 that is out of range was specified. 				○		W528
54013834 hex	ACKC7A Out of Range	An ACKC7A that is out of range was specified and the instruction was executed.	<ul style="list-style-type: none"> An ACKC7A that is out of range was specified. 				○		W528
54013835 hex	ACKC10 Out of Range	An ACKC10 that is out of range was specified and the instruction was executed.	<ul style="list-style-type: none"> An ACKC10 that is out of range was specified. 				○		W528
54013836 hex	EAC Out of Range	An EAC that is out of range was specified and the instruction was executed.	<ul style="list-style-type: none"> An EAC that is out of range was specified. 				○		W528
54013838 hex	Illegal SECS Message	A message number for which an illegal SECS message is set was specified and the instruction was executed.	<ul style="list-style-type: none"> A message number for which a SECS message that does not agree with the instruction specifications was specified. 				○		W528

A-1-3 Errors in Robot Control Function

This section provides tables of the errors (events) that can occur in the robot control functions and robot control instructions.

You can use the robot control functions and robot control instructions with the NJ501-R□□□ CPU Unit. The unit version of the CPU Unit is 1.41 or later.

General Robot Control

The manual names are given below for the catalog numbers given in the Reference column of the event table.

Cat. No.	Manual name
O037	NJ-series Robot Integrated CPU Unit User's Manual

Event code	Event name	Meaning	Assumed cause	Level					Reference
				M a j	P r t	M i n	O b s	I n f o	
17C00000 hex	Robot Control Parameter Setting Error	The robot control parameter settings that were saved in non-volatile memory are missing.	<ul style="list-style-type: none"> The power supply to the Controller was interrupted or communications with the Sysmac Studio were disconnected while downloading the robot control parameter settings or clearing memory. Built-in non-volatile memory in the CPU Unit failed. 		○				O037
17C10000 hex	Remove SD Memory Card with Robot Control Function Enabled	The SD Memory Card was removed when the robot control function was enabled.	<ul style="list-style-type: none"> The SD Memory Card was removed when the robot control function was enabled. The files related to the robot control function in the SD Memory Card were edited or deleted when the robot control function was enabled. 		○				O037
17C20000 hex	Robot Control Function Enabled without SD Memory Card	The robot control function was enabled without inserting an SD Memory Card.	<ul style="list-style-type: none"> More than one robot device was assigned to the Robot Basic Settings and the robot control function was enabled without inserting an SD Memory Card. An SD Memory Card was inserted, however, it cannot be written due to write-protection, insufficient memory, or damage. 		○				O037
37C00000 hex	Required Process Data Object Not Set	The object that is absolutely required for the robot is not allocated to PDO.	<ul style="list-style-type: none"> The PDOs that are required for the robot are not mapped. Non-volatile memory failed. 		○				O037

Event code	Event name	Meaning	Assumed cause	Level					Reference
				M a j	P r t	M i n	O b s	I n f o	
37C20000 hex	Robot Setting Mismatch	A mismatch was detected for the robot settings in the non-volatile memory and the SD Memory Card.	<ul style="list-style-type: none"> An SD Memory Card was replaced. The files related to the robot control function in the SD Memory Card were overwritten without using the Sysmac Studio. 		○				O037
47C00000 hex	Robot Control Initialization Error	Initialization of the Robot Control Function Module failed.	The CPU Unit has failed.		○				O037
47C10000 hex	Robot Control Function Module System Error	A fatal error was detected in the Robot Control Function Module.	A fatal error was detected in the Robot Control Function Module.		○				O037
75000000 hex	Robot Control Period Exceeded	The robot control processing failures occurred two consecutive times during task period of primary periodic task.	<ul style="list-style-type: none"> The task period of primary periodic task is too short for the amount of the user program that is executed in the primary periodic task. Too many robot control instructions are executed for the task period of primary periodic task. 		○				O037
47C20000 hex	Robot Control Function Module Processing Error	An unexpected error occurred in the Robot Control Function Module.	An unexpected error was detected in the Robot Control Function Module.			○			O037
55100000 hex	Robot Control Instruction Re-execution Disabled	An attempt was made to re-execute a robot control instruction that cannot be re-executed.	The <i>Execute</i> (Execute) input variable was re-executed during execution of the robot control instruction that has the <i>Execute</i> (Execute) input variable.			○			O037
55110000 hex	V+ Task Number Setting Out of Range	The value of <i>TaskNo</i> (Task Number) input variable to a robot control instruction is out of range.	Instruction input parameter exceeded the valid range of the input variable.			○			O037
55120000 hex	Illegal Robot Specification	The robot specified for the <i>Robot</i> (Robot) in-out variable to a robot control instruction does not exist.	The value of variable that is used for the subscript for array of <i>_RC_RBT[]</i> robot variable specified for the <i>Robot</i> (Robot) in-out variable to an instruction, is specified to the robot that does not exist.			○			O037
55130000 hex	Illegal Parameter List Specification	The value of <i>PrgParam</i> (Parameter List) input variable to a robot control instruction is not correct.	The length of the parameter list specified for the <i>PrgParam</i> (Parameter List) input variable to an instruction was outside of the valid range.			○			O037

Event code	Event name	Meaning	Assumed cause	Level					Reference
				M a j	P r t	M i n	O b s	I n f o	
55140000 hex	Starting Step Setting Out of Range	The parameter specified in the <i>StartStep</i> (Start Step) input variable to a robot control instruction is out of range.	Instruction input parameter exceeded the valid range of the input variable.			○			O037
55150000 hex	Target Position Setting Out of Range	The value of <i>Position</i> (Target Position) input variable to a robot control instruction is out of range.	Instruction input parameter exceeded the valid range of the input variable.			○			O037
55160000 hex	Lefty and Righty Setting Out of Range	The value of <i>LeftyRighty</i> (Lefty/Righty Setting) member in the <i>ArmConfig</i> (Arm Configuration) input variable to a robot control instruction is out of range.	Instruction input parameter exceeded the valid range of the input variable.			○			O037
55170000 hex	Above and Below Setting Out of Range	The value of <i>AboveBelow</i> (Above/Below Setting) member in the <i>ArmConfig</i> (Arm Configuration) input variable to a robot control instruction is out of range.	Instruction input parameter exceeded the valid range of the input variable.			○			O037
55180000 hex	Flip Setting Out of Range	The value of <i>Flip</i> (Flip Setting) member in the <i>ArmConfig</i> (Arm Configuration) input variable to a robot control instruction is out of range.	Instruction input parameter exceeded the valid range of the input variable.			○			O037
55190000 hex	Velocity Profile Selection Out of Range	The value of <i>VelocityProfile</i> (Velocity Profile) member in the <i>MotionParams</i> (Motion Parameters) input variable to a robot control instruction is out of range.	Instruction input parameter exceeded the valid range of the input variable.			○			O037
551A0000 hex	Velocity Mode Selection Out of Range	The value of <i>VelocityMode</i> (Velocity Selection) member in the <i>MotionParams</i> (Motion Parameters) input variable to a robot control instruction is out of range.	Instruction input parameter exceeded the valid range of the input variable.			○			O037

Event code	Event name	Meaning	Assumed cause	Level					Reference
				M a j	P r t	M i n	O b s	I n f o	
551B0000 hex	Velocity Ratio Setting Out of Range	The value of <i>VelocityRatio</i> (Velocity Ratio) member in the <i>MotionParams</i> (Motion Parameters) input variable to a robot control instruction is out of range.	Instruction input parameter exceeded the valid range of the input variable.			○			O037
551C0000 hex	Rotation Velocity Ratio Setting Out of Range	The value of <i>RotationVelocityRatio</i> (Rotation Velocity Ratio) member in the <i>MotionParams</i> (Motion Parameters) input variable to a robot control instruction is out of range.	Instruction input parameter exceeded the valid range of the input variable.			○			O037
551D0000 hex	Velocity Setting Out of Range	The value of <i>Velocity</i> (Velocity) member in the <i>MotionParams</i> (Motion Parameters) input variable to a robot control instruction is out of range. The value of <i>Velocity</i> (Velocity) input variable or <i>Velocity</i> (Velocity) member in the <i>MotionParams</i> (Motion Parameters) input variable to a robot control instruction is out of range.	Instruction input parameter exceeded the valid range of the input variable.			○			O037
551E0000 hex	Acceleration Ratio Setting Out of Range	The value of <i>AccelerationRatio</i> (Acceleration Ratio) member in the <i>MotionParams</i> (Motion Parameters) input variable to a robot control instruction is out of range.	Instruction input parameter exceeded the valid range of the input variable.			○			O037
551F0000 hex	Deceleration Ratio Setting Out of Range	The value of <i>DecelerationRatio</i> (Deceleration Ratio) member in the <i>MotionParams</i> (Motion Parameters) input variable to a robot control instruction is out of range.	Instruction input parameter exceeded the valid range of the input variable.			○			O037

Event code	Event name	Meaning	Assumed cause	Level					Reference
				M a j	P r t	M i n	O b s	I n f o	
55200000 hex	Positioning Accuracy Selection Out of Range	The value of <i>NullingTolerance</i> (Positioning Accuracy) member in the <i>MotionParams</i> (Motion Parameters) input variable to a robot control instruction is out of range.	Instruction input parameter exceeded the valid range of the input variable.			○			O037
55210000 hex	Rotation Limit Selection Out of Range	The value of <i>SingleTurn</i> (Rotation Limit) member in the <i>MotionParams</i> (Motion Parameters) input variable to a robot control instruction is out of range.	Instruction input parameter exceeded the valid range of the input variable.			○			O037
55220000 hex	Buffer Mode Selection Out of Range	The value of <i>BufferMode</i> (Buffer Mode Selection) input variable to a robot control instruction is out of range.	Instruction input parameter exceeded the valid range of the input variable.			○			O037
55230000 hex	Target Position Specification Method Setting Out of Range	The value of <i>PositionMode</i> (Target Position Specification Method) input variable to a robot control instruction is out of range.	Instruction input parameter exceeded the valid range of the input variable.			○			O037
55240000 hex	Master Machine ID Setting Out of Range	The value of <i>MasterID</i> (Master Machine ID) input variable to a robot control instruction is out of range.	Instruction input parameter exceeded the valid range of the input variable.			○			O037
55250000 hex	Belt ID Setting Out of Range	The value of <i>BeltID</i> (Belt Number) input variable to a robot control instruction is out of range.	Instruction input parameter exceeded the valid range of the input variable.			○			O037
55260000 hex	Scale Factor Setting Out of Range	The value of <i>ScaleFactor</i> (Scale Factor) member in the <i>BeltData</i> (Belt Data) input variable to a robot control instruction is out of range.	Instruction input parameter exceeded the valid range of the input variable.			○			O037

A

Event code	Event name	Meaning	Assumed cause	Level					Reference
				M a j	P r t	M i n	O b s	I n f o	
55270000 hex	Coordinate System Setting Out of Range	The value of <i>CoordTransform</i> (Coordinate System) member in the <i>BeltData</i> (Belt Data), <i>AxisData</i> (Axis Data), <i>AxesGroupData</i> (Axes Group Data), or <i>RobotData</i> (Robot Data) input variable to a robot control instruction is out of range.	Instruction input parameter exceeded the valid range of the input variable.			○			O037
55280000 hex	Upstream Limit Setting Out of Range	The value of <i>Upstream</i> (Upstream Limit) member in the <i>BeltData</i> (Belt Data) or <i>AxisData</i> (Axis Data) input variable to a robot control instruction is out of range.	Instruction input parameter exceeded the valid range of the input variable.			○			O037
55290000 hex	Downstream Limit Setting Out of Range	The value of <i>Downstream</i> (Downstream Limit) member in the <i>BeltData</i> (Belt Data) or <i>AxisData</i> (Axis Data) input variable to a robot control instruction is out of range.	Instruction input parameter exceeded the valid range of the input variable.			○			O037
552A0000 hex	Sensor Coordinate System Setting Out of Range	The value of <i>SensorCoordTransform</i> (Sensor Coordinate System) member in the <i>BeltData</i> (Belt Data), <i>AxisData</i> (Axis Data), or <i>AxesGroupData</i> (Axes Group Data) input variable to a robot control instruction is out of range.	Instruction input parameter exceeded the valid range of the input variable.			○			O037

Event code	Event name	Meaning	Assumed cause	Level					Reference
				M a j	P r t	M i n	O b s	I n f o	
552B0000 hex	Position Type Selection Out of Range	The value of <i>ReferecneType</i> (Position Type Selection) member in the <i>AxisData</i> (Axis Data), <i>AxesGroupData</i> (Axes Group Data), or <i>RobotData</i> (Robot Data) input variable to a robot control instruction is out of range.	Instruction input parameter exceeded the valid range of the input variable.			○			O037
552C0000 hex	Axis Assignment Out of Range	The value of <i>Assignment</i> (Axis Assignment) member in the <i>AxesGroupData</i> (Axes Group Data) input variable to a robot control instruction is out of range.	Instruction input parameter exceeded the valid range of the input variable.			○			O037
552D0000 hex	Offset Position Setting Out of Range	The value of <i>OffsetPosition</i> (Offset Position) input variable to a robot control instruction is out of range.	Instruction input parameter exceeded the valid range of the input variable.			○			O037
552E0000 hex	Depart Height Setting Out of Range	The value of <i>DepartHeight</i> (Depart Height) input variable to a robot control instruction is out of range.	Instruction input parameter exceeded the valid range of the input variable.			○			O037
552F0000 hex	Target Offset Setting Out of Range	The value of <i>Offset</i> (Target Offset) input variable to a robot control instruction is out of range.	Instruction input parameter exceeded the valid range of the input variable.			○			O037
55300000 hex	Acceleration Setting Out of Range	The value of <i>Acceleration</i> (Acceleration) input variable to a robot control instruction is out of range.	Instruction input parameter exceeded the valid range of the input variable.			○			O037
55310000 hex	Deceleration Setting Out of Range	The value of <i>Deceleration</i> (Deceleration) input variable to a robot control instruction is out of range.	Instruction input parameter exceeded the valid range of the input variable.			○			O037

Event code	Event name	Meaning	Assumed cause	Level					Reference
				M a j	P r t	M i n	O b s	I n f o	
55320000 hex	Jerk Setting Out of Range	The value of <i>Jerk</i> (Jerk) input variable to a robot control instruction is out of range.	Instruction input parameter exceeded the valid range of the input variable.			○			O037
55330000 hex	Robot Control Instruction Executed while Robot is not Attached	An instruction required that a robot has been attached was executed for the robot that has not been attached.	An instruction that controls a robot was executed for the robot that has not been attached.			○			O037
55340000 hex	Synchronization Ratio Setting Out of Range	The value of <i>SyncRatio</i> (Synchronization Ratio) in the <i>AxisData</i> (Axis Data), <i>AxesGroupData</i> (Axes Group Data), or <i>RobotData</i> (Robot Data) input variable to a robot control instruction is out of range.	Instruction input parameter exceeded the valid range of the input variable.			○			O037
55350000 hex	Tool Coordination Transform Setting Out of Range	The value of <i>ToolCoordTransform</i> (Tool Conversion Coordinates) input variable to a robot control instruction is out of range.	Instruction input parameter exceeded the valid range of the input variable.			○			O037
55360000 hex	Robot Control Instruction Multi-execution Disabled	Multiple robot control instructions that cannot be executed simultaneously were executed.	Multiple robot control instructions that cannot be executed simultaneously were executed.			○			O037
55370000 hex	Cannot Execute Robot Control Instruction during Synchronization	An instruction that cannot be executed during the synchronization was executed for a robot that was synchronized.	The RC_MoveDirect (Robot Joint Interpolation) instruction was executed for a robot that was synchronized.			○			O037
55380000 hex	Illegal Master Machine Specification	The master machine specified for the <i>MasterID</i> (Master Machine ID) input variable to a robot control instruction is not defined or the machine type is not correct.	<ul style="list-style-type: none"> The master machine specified in the <i>MasterID</i> (Master Machine ID) input variable to the instruction is not defined. The machine type specified for the <i>MasterID</i> (Master Machine ID) input variable of the RC_ReadBeltLatch (Read Belt Latch) instruction, is not a belt. 			○			O037

Event code	Event name	Meaning	Assumed cause	Level					Reference
				M a j	P r t	M i n	O b s	I n f o	
55390000 hex	Illegal Axis Assignment	Multiple axes were assigned to the same element of the axis group coordinate system.	The specified value of <i>Assignment</i> (Axis Assignment) in the <i>AxesGroupData</i> (Axes Group Data) input variable to the RC_DefineGroup (Define Master Axes Group) instruction, is duplicated.			○			O037
553A0000 hex	Synchronization Stopped	An instruction that can be executed only during synchronization was executed for a robot that was not synchronized.	The RC_SyncOut (End Robot Synchronization) instruction or RC_MasterOffset (Master Position Compensation) instruction was executed for a robot that was not synchronized.			○			O037
553C0000 hex	Robot Control Instruction Multi-execution Buffer Limit Exceeded	The number of multi-execution for the robot control instructions exceeded the upper limit.	The total number of current robot control instructions and buffered robot control instructions exceeded eight.			○			O037
553D0000 hex	Robot Control Instruction Executed with Calibration Not Completed	An instruction that is required for the calibration completion was executed for a robot whose calibration was not completed.	<ul style="list-style-type: none"> An instruction that controls a robot was executed for the robot that the calibration has not been completed. An instruction to synchronize the master machine and the robot was executed for a robot whose calibration was not completed. 			○			O037
553E0000 hex	Robot Control Instruction Executed while Robot High Power is OFF	An instruction required for the robot in a Power Enabled state was executed for the robot in which high power turns OFF.	An instruction that controls a robot was executed for the robot in which high power turns OFF.			○			O037
553F0000 hex	Robot Already Attached	An attempt was made to attach a robot again or execute calibration for the robot that was already attached.	The target robot was already attached in the sequence control program.			○			O037
55400000 hex	Robot Control Instruction Executed while Robot is MANUAL Mode or is not COMP Mode	A robot control instruction for which the robot is MANUAL mode or is not COMP mode was executed.	<ul style="list-style-type: none"> The robot that you control is MANUAL mode. The robot in Auto mode that you control is not COMP mode. 			○			O037
55410000 hex	Illegal Master Axis Specification	The axis specified for the master machine does not exist.	An axis does not exist for the variable specified for the <i>Axis</i> (Axis) in-out variable to the instruction.			○			O037

Event code	Event name	Meaning	Assumed cause	Level					Reference
				M a j	P r t	M i n	O b s	I n f o	
55420000 hex	Illegal Master Axes Group Specification	The axes group that is specified for the master machine does not exist.	An axes group does not exist for the variable specified for the <i>AxesGroup</i> (Axes Group) in-out variable to the instruction.			○			O037
55430000 hex	Illegal Master Robot Specification	The robot specified for the master machine does not exist.	A robot does not exist for the variable specified for the <i>MasterRobot</i> (Master Robot) in-out variable to the instruction.			○			O037
55440000 hex	Cannot Execute Robot Control Instruction	The Robot Control Function Module is not running.	The robot control instruction was executed while the Robot Control Function Module was not running.			○			O037
55450000 hex	Master Machine in Synchronized Control	The master machine specified for the <i>MasterID</i> (Master Machine ID) input variable to a robot control instruction is being used for synchronized control.	For the master machine that is currently used for synchronized control, an attempt was made to overwrite the definition of the master machine.			○			O037
55460000 hex	Master Position Compensation Enabled	Multiple Master Position Compensation instructions were enabled for the same robot.	For a robot whose master position was being corrected, an attempt was made to enable another Master Position Compensation instruction.			○			O037
55470000 hex	Simultaneous Master Machine Definition	The master machine specified for the <i>MasterID</i> (Master Machine ID) input variable to a robot control instruction is defined with another instruction.	For the master machine specified for the <i>MasterID</i> (Master Machine ID) input variable to the instruction, an attempt was made to execute multiple defining operations at the same time.			○			O037
55480000 hex	Illegal Program Name Specification	The program name specified for the <i>PrgName</i> (Program Name) input variable to a robot control instruction is incorrect.	The length of the program name specified for the <i>PrgName</i> (Program Name) input variable to the instruction was outside of the valid range.			○			O037
55490000 hex	Cannot Read Belt Latch Simultaneously	Multiple Read Belt Latch instructions were executed for the same belt.	For the belt for which a Read Belt Latch instruction was already being executed, an attempt was made to execute another Read Belt Latch instruction.			○			O037
554A0000 hex	Unsupported Function Executed	The function that is not supported was executed.	The function that is not supported by the robot was executed.			○			O037
554B0000 hex	Illegal IP Address Specification	The value of <i>IPAddr</i> input variable to a robot control instruction is not correct.	The length of the parameter list specified for the <i>IPAddr</i> input variable to an instruction was outside of the valid range.			○			O037

Event code	Event name	Meaning	Assumed cause	Level					Reference
				M a j	P r t	M i n	O b s	I n f o	
554C0000 hex	Vision Error Occurred	An error occurred during execution of the vision function in the IPC Application Controller from a sequence control program.	An error occurred during execution of the vision function in the IPC Application Controller.			○			O037
75010000 hex	Robot Control Common Error Occurred	A robot control common error occurred.	A partial fault level robot control common error occurred.			○			O037
75020000 hex	EtherCAT Slave Disconnection Error	One of the following occurred for the EtherCAT slave that is allocated to a robot. <ul style="list-style-type: none"> • Disconnect or replace the slave • Disable the slave 	One of the following occurred for the EtherCAT slave that is allocated to a robot. <ul style="list-style-type: none"> • Disconnection or replacement • Disablement 			○			O037
75030000 hex	Robot Error Occurred	An error occurred in the robot that the robot control instruction execution is in progress.	An error occurred in the robot that the robot control instruction execution is in progress.			○			O037
75040000 hex	Robot Control Period Exceeded	The robot control processing failures occurred two consecutive times during task period of primary periodic task.	<ul style="list-style-type: none"> • The task period of primary periodic task is too short for the amount of the user program that is executed in the primary periodic task. • Too many robot control instructions are executed for the task period of primary periodic task. 			○			O037
85800000 hex	EtherCAT Slave Communications Error	A communications error occurred for the EtherCAT slave that is allocated to a robot.	A communications error occurred for the EtherCAT slave that is allocated to a robot.			○			O037
96040000 hex	V+ Program Error	An error occurred in the V+ program.	An error occurred in the V+ program that was being executed.					○	O037
96050000 hex	V+ Program Warning	The V+ program issued a warning message.	The V+ program that was being executed issued a warning message.					○	O037
96060000 hex	V+ Program Information	The V+ program issued an information message.	The V+ program that was being executed issued an information message.					○	O037
96090000 hex	Robot Manual Mode Started	The robot was set to Manual mode.	The robot was set to Manual mode.					○	O037
960A0000 hex	Robot Auto Mode Started	The robot was set to Auto mode.	The robot was set to Auto mode.					○	O037

Robot Control Instructions

The lower four digits of the event code represents the error code (ErrorID) for the instruction. For descriptions of error codes, refer to the description of the corresponding event code. For example, if the error code of the instruction is 16#5510, refer to the description of event code 54015510 hex.

The manual names are given below for the catalog numbers given in the Reference column of the event table.

Cat. No.	Manual name
O037	NJ-series Robot Integrated CPU Unit User's Manual

Event code	Event name	Meaning	Assumed cause	Level					Reference
				M a j	P r t	M i n	O b s	I n f o	
54015510 hex	Robot Control Instruction Re-execution Disabled	An attempt was made to re-execute a robot control instruction that cannot be re-executed.	The <i>Execute</i> (Execute) input variable was re-executed during execution of the robot control instruction that has the <i>Execute</i> (Execute) input variable.					○	O037
54015511 hex	V+ Task Number Setting Out of Range	The value of <i>TaskNo</i> (Task Number) input variable to a robot control instruction is out of range.	Instruction input parameter exceeded the valid range of the input variable.					○	O037
54015512 hex	Illegal Robot Specification	The robot specified for the <i>Robot</i> (Robot) in-out variable to a robot control instruction does not exist.	The value of variable that is used for the subscript for array of <i>_RC_RBT[]</i> robot variable specified for the <i>Robot</i> (Robot) in-out variable to a instruction, is specified to the robot that does not exist.					○	O037
54015513 hex	Illegal Parameter List Specification	The value of <i>PrgParam</i> (Parameter List) input variable to a robot control instruction is not correct.	The length of the parameter list specified for the <i>PrgParam</i> (Parameter List) input variable to an instruction was outside of the valid range.					○	O037
54015514 hex	Starting Step Setting Out of Range	The value specified in the <i>StartStep</i> (Start Step) input variable to a robot control instruction is out of range.	Instruction input parameter exceeded the valid range of the input variable.					○	O037
54015515 hex	Target Position Setting Out of Range	The value of <i>Position</i> (Target Position) input variable to a robot control instruction is out of range.	Instruction input parameter exceeded the valid range of the input variable.					○	O037

A

Event code	Event name	Meaning	Assumed cause	Level					Reference
				M a j	P r t	M i n	O b s	I n f o	
54015516 hex	Lefty and Righty Setting Out of Range	The value of <i>LeftyRighty</i> (Lefty/Righty Setting) member in the <i>ArmConfig</i> (Arm Configuration) input variable to a robot control instruction is out of range.	Instruction input parameter exceeded the valid range of the input variable.				○		O037
54015517 hex	Above and Below Setting Out of Range	The value of <i>AboveBelow</i> (Above/Below Setting) member in the <i>ArmConfig</i> (Arm Configuration) input variable to a robot control instruction is out of range.	Instruction input parameter exceeded the valid range of the input variable.				○		O037
54015518 hex	Flip Setting Out of Range	The value of <i>Flip</i> (Flip Setting) member in the <i>ArmConfig</i> (Arm Configuration) input variable to a robot control instruction is out of range.	Instruction input parameter exceeded the valid range of the input variable.				○		O037
54015519 hex	Velocity Profile Selection Out of Range	The value of <i>VelocityProfile</i> (Velocity Profile) member in the <i>MotionParams</i> (Motion Parameters) input variable to a robot control instruction is out of range.	Instruction input parameter exceeded the valid range of the input variable.				○		O037
5401551A hex	Velocity Mode Selection Out of Range	The value of <i>VelocityMode</i> (Velocity Selection) member in the <i>MotionParams</i> (Motion Parameters) input variable to a robot control instruction is out of range.	Instruction input parameter exceeded the valid range of the input variable.				○		O037
5401551B hex	Velocity Ratio Setting Out of Range	The value of <i>VelocityRatio</i> (Velocity Ratio) member in the <i>MotionParams</i> (Motion Parameters) input variable to a robot control instruction is out of range.	Instruction input parameter exceeded the valid range of the input variable.				○		O037

Event code	Event name	Meaning	Assumed cause	Level					Reference
				M a j	P r t	M i n	O b s	I n f o	
5401551C hex	Rotation Velocity Ratio Setting Out of Range	The value of <i>RotationVelocityRatio</i> (Rotation Velocity Ratio) member in the <i>MotionParams</i> (Motion Parameters) input variable to a robot control instruction is out of range.	Instruction input parameter exceeded the valid range of the input variable.				○		O037
5401551D hex	Velocity Setting Out of Range	The value of <i>Velocity</i> (Velocity) member in the <i>MotionParams</i> (Motion Parameters) input variable to a robot control instruction is out of range. The value of <i>Velocity</i> (Velocity) input variable or <i>Velocity</i> (Velocity) member in the <i>MotionParams</i> (Motion Parameters) input variable to a robot control instruction is out of range.	Instruction input parameter exceeded the valid range of the input variable.				○		O037
5401551E hex	Acceleration Ratio Setting Out of Range	The value of <i>AccelerationRatio</i> (Acceleration Ratio) member in the <i>MotionParams</i> (Motion Parameters) input variable to a robot control instruction is out of range.	Instruction input parameter exceeded the valid range of the input variable.				○		O037
5401551F hex	Deceleration Ratio Setting Out of Range	The value of <i>DecelerationRatio</i> (Deceleration Ratio) member in the <i>MotionParams</i> (Motion Parameters) input variable to a robot control instruction is out of range.	Instruction input parameter exceeded the valid range of the input variable.				○		O037
54015520 hex	Positioning Accuracy Selection Out of Range	The value of <i>NullingTolerance</i> (Positioning Accuracy) member in the <i>MotionParams</i> (Motion Parameters) input variable to a robot control instruction is out of range.	Instruction input parameter exceeded the valid range of the input variable.				○		O037

Event code	Event name	Meaning	Assumed cause	Level					Reference
				M a j	P r t	M i n	O b s	I n f o	
54015521 hex	Rotation Limit Selection Out of Range	The value of <i>SingleTurn</i> (Rotation Limit) member in the <i>MotionParams</i> (Motion Parameters) input variable to a robot control instruction is out of range.	Instruction input parameter exceeded the valid range of the input variable.				○		O037
54015522 hex	Buffer Mode Selection Out of Range	The value of <i>BufferMode</i> (Buffer Mode Selection) input variable to a robot control instruction is out of range.	Instruction input parameter exceeded the valid range of the input variable.				○		O037
54015523 hex	Target Position Specification Method Setting Out of Range	The value of <i>PositionMode</i> (Target Position Specification Method) input variable to a robot control instruction is out of range.	Instruction input parameter exceeded the valid range of the input variable.				○		O037
54015524 hex	Master Machine ID Setting Out of Range	The value of <i>MasterID</i> (Master Machine ID) input variable to a robot control instruction is out of range.	Instruction input parameter exceeded the valid range of the input variable.				○		O037
54015525 hex	Belt ID Setting Out of Range	The value of <i>BeltID</i> (Belt Number) input variable to a robot control instruction is out of range.	Instruction input parameter exceeded the valid range of the input variable.				○		O037
54015526 hex	Scale Factor Setting Out of Range	The value of <i>ScaleFactor</i> (Scale Factor) member in the <i>BeltData</i> (Belt Data) input variable to a robot control instruction is out of range.	Instruction input parameter exceeded the valid range of the input variable.				○		O037
54015527 hex	Coordinate System Setting Out of Range	The value of <i>CoordTransform</i> (Coordinate System) member in the <i>BeltData</i> (Belt Data), <i>AxisData</i> (Axis Data), <i>AxesGroupData</i> (Axes Group Data), or <i>RobotData</i> (Robot Data) input variable to a robot control instruction is out of range.	Instruction input parameter exceeded the valid range of the input variable.				○		O037

Event code	Event name	Meaning	Assumed cause	Level					Reference
				M a j	P r t	M i n	O b s	I n f o	
54015528 hex	Upstream Limit Setting Out of Range	The value of <i>Upstream</i> (Upstream Limit) member in the <i>BeltData</i> (Belt Data) or <i>AxisData</i> (Axis Data) input variable to a robot control instruction is out of range.	Instruction input parameter exceeded the valid range of the input variable.				○		O037
54015529 hex	Downstream Limit Setting Out of Range	The value of <i>Downstream</i> (Downstream Limit) member in the <i>BeltData</i> (Belt Data) or <i>AxisData</i> (Axis Data) input variable to a robot control instruction is out of range.	Instruction input parameter exceeded the valid range of the input variable.				○		O037
5401552A hex	Sensor Coordinate System Setting Out of Range	The value of <i>SensorCoordTransform</i> (Sensor Coordinate System) member in the <i>BeltData</i> (Belt Data), <i>AxisData</i> (Axis Data), or <i>AxesGroupData</i> (Axes Group Data) input variable to a robot control instruction is out of range.	Instruction input parameter exceeded the valid range of the input variable.				○		O037
5401552B hex	Position Type Selection Out of Range	The value of <i>ReferecneType</i> (Position Type Selection) member in the <i>AxisData</i> (Axis Data), <i>AxesGroupData</i> (Axes Group Data), or <i>RobotData</i> (Robot Data) input variable to a robot control instruction is out of range.	Instruction input parameter exceeded the valid range of the input variable.				○		O037
5401552C hex	Axis Assignment Out of Range	The value of <i>Assignment</i> (Axis Assignment) member in the <i>AxesGroupData</i> (Axes Group Data) input variable to a robot control instruction is out of range.	Instruction input parameter exceeded the valid range of the input variable.				○		O037

Event code	Event name	Meaning	Assumed cause	Level					Reference
				M a j	P r t	M i n	O b s	I n f o	
5401552D hex	Offset Position Setting Out of Range	The value of <i>OffsetPosition</i> (Offset Position) input variable to a robot control instruction is out of range.	Instruction input parameter exceeded the valid range of the input variable.				○		O037
5401552E hex	Depart Height Setting Out of Range	The value of <i>DepartHeight</i> (Depart Height) input variable to a robot control instruction is out of range.	Instruction input parameter exceeded the valid range of the input variable.				○		O037
5401552F hex	Target Offset Setting Out of Range	The value of <i>Offset</i> (Target Offset) input variable to a robot control instruction is out of range.	Instruction input parameter exceeded the valid range of the input variable.				○		O037
54015530 hex	Acceleration Setting Out of Range	The value of <i>Acceleration</i> (Acceleration) input variable to a robot control instruction is out of range.	Instruction input parameter exceeded the valid range of the input variable.				○		O037
54015531 hex	Deceleration Setting Out of Range	The value of <i>Deceleration</i> (Deceleration) input variable to a robot control instruction is out of range.	Instruction input parameter exceeded the valid range of the input variable.				○		O037
54015532 hex	Jerk Setting Out of Range	The value of <i>Jerk</i> (Jerk) input variable to a robot control instruction is out of range.	Instruction input parameter exceeded the valid range of the input variable.				○		O037
54015533 hex	Robot Control Instruction Executed while Robot is not Attached	An instruction required that a robot has been attached was executed for the robot that has not been attached.	An instruction that controls a robot was executed for the robot that has not been attached.				○		O037
54015534 hex	Synchronization Ratio Setting Out of Range	The value of <i>SyncRatio</i> (Synchronization Ratio) in the <i>AxisData</i> (Axis Data), <i>AxesGroupData</i> (Axes Group Data), or <i>RobotData</i> (Robot Data) input variable to a robot control instruction is out of range.	Instruction input parameter exceeded the valid range of the input variable.				○		O037

Event code	Event name	Meaning	Assumed cause	Level					Reference
				M a j	P r t	M i n	O b s	I n f o	
54015535 hex	Tool Coordination Transform Setting Out of Range	The value of <i>ToolCoordTransform</i> (Tool Conversion Coordinates) input variable to a robot control instruction is out of range.	Instruction input parameter exceeded the valid range of the input variable.				○		O037
54015536 hex	Robot Control Instruction Multi-execution Disabled	Multiple robot control instructions that cannot be executed simultaneously were executed.	Multiple robot control instructions that cannot be executed simultaneously were executed.				○		O037
54015537 hex	Cannot Execute Robot Control Instruction during Synchronization	An instruction that cannot be executed during the synchronization was executed for a robot that was synchronized.	The RC_MoveDirect (Robot Joint Interpolation) instruction was executed for a robot that was synchronized.				○		O037
54015538 hex	Illegal Master Machine Specification	The master machine specified for the <i>MasterID</i> (Master Machine ID) input variable to a robot control instruction is not defined or the machine type is not correct.	<ul style="list-style-type: none"> The master machine specified in the <i>MasterID</i> (Master Machine ID) input variable to the instruction is not defined. The machine type specified for the <i>MasterID</i> (Master Machine ID) input variable of the RC_ReadBeltLatch (Read Belt Latch) instruction, is not a belt. 				○		O037
54015539 hex	Illegal Axis Assignment	Multiple axes were assigned to the same element of the axis group coordinate system.	The specified value of <i>Assignment</i> (Axis Assignment) in the <i>AxesGroupData</i> (Axes Group Data) input variable to the RC_DefineGroup (Define Master Axes Group) instruction, is duplicated.				○		O037
5401553A hex	Synchronization Stopped	An instruction that can be executed only during synchronization was executed for a robot that was not synchronized.	The RC_SyncOut (End Robot Synchronization) instruction or RC_MasterOffset (Master Position Compensation) instruction was executed for a robot that was not synchronized.				○		O037
5401553C hex	Robot Control Instruction Multi-execution Buffer Limit Exceeded	The number of multi-execution for the robot control instructions exceeded the upper limit.	The total number of current robot control instructions and buffered robot control instructions exceeded eight.				○		O037

Event code	Event name	Meaning	Assumed cause	Level					Reference
				M a j	P r t	M i n	O b s	I n f o	
5401553D hex	Robot Control Instruction Executed with Calibration Not Completed	An instruction that is required for the calibration completion was executed for a robot whose calibration was not completed.	<ul style="list-style-type: none"> An instruction that controls a robot was executed for the robot that the calibration has not been completed. An instruction to synchronize the master machine and the robot was executed for a robot whose calibration was not completed. 				○		O037
5401553E hex	Robot Control Instruction Executed while Robot High Power is OFF	An instruction required for the robot in a Power Enabled state was executed for the robot in which high power turns OFF.	An instruction that controls a robot was executed for the robot in which high power turns OFF.				○		O037
5401553F hex	Robot Already Attached	An attempt was made to attach a robot again or execute calibration for the robot that was already attached.	The target robot was already attached in the sequence control program.				○		O037
54015540 hex	Robot Control Instruction Executed while Robot is MANUAL Mode or is not COMP Mode	A robot control instruction for which the robot is MANUAL mode or is not COMP mode was executed.	<ul style="list-style-type: none"> The robot that you control is MANUAL mode. The robot in Auto mode that you control is not COMP mode. 				○		O037
54015541 hex	Illegal Master Axis Specification	The axis specified for the master machine does not exist.	An axis does not exist for the variable specified for the <i>Axis</i> (Axis) in-out variable to the instruction.				○		O037
54015542 hex	Illegal Master Axes Group Specification	The axes group that is specified for the master machine does not exist.	An axes group does not exist for the variable specified for the <i>AxesGroup</i> (Axes Group) in-out variable to the instruction.				○		O037
54015543 hex	Illegal Master Robot Specification	The robot specified for the master machine does not exist.	A robot does not exist for the variable specified for the <i>MasterRobot</i> (Master Robot) in-out variable to the instruction.				○		O037
54015544 hex	Cannot Execute Robot Control Instruction	The Robot Control Function Module is not running.	The robot control instruction was executed while the Robot Control Function Module was not running.				○		O037

A

Event code	Event name	Meaning	Assumed cause	Level					Reference
				M a j	P r t	M i n	O b s	I n f o	
54015545 hex	Master Machine in Synchronized Control	The master machine specified for the <i>MasterID</i> (Master Machine ID) input variable to a robot control instruction is being used for synchronized control.	For the master machine that is currently used for synchronized control, an attempt was made to overwrite the definition of the master machine.				○		O037
54015546 hex	Master Position Compensation Enabled	Multiple Master Position Compensation instructions were enabled for the same robot.	For a robot whose master position was being corrected, an attempt was made to enable another Master Position Compensation instruction.				○		O037
54015547 hex	Simultaneous Master Machine Definition	The master machine specified for the <i>MasterID</i> (Master Machine ID) input variable to a robot control instruction is defined with another instruction.	For the master machine specified for the <i>MasterID</i> (Master Machine ID) input variable to the instruction, an attempt was made to execute multiple defining operations at the same time.				○		O037
54015548 hex	Illegal Program Name Specification	The program name specified for the <i>PrgName</i> (Program Name) input variable to a robot control instruction is incorrect.	The length of the program name specified for the <i>PrgName</i> (Program Name) input variable to the instruction was outside of the valid range.				○		O037
54015549 hex	Cannot Read Belt Latch Simultaneously	More than one Read Belt Latch instruction was executed for the same belt at the same time.	For the belt for which a Read Belt Latch instruction was already being executed, an attempt was made to execute another Read Belt Latch instruction.				○		O037
5401554A hex	Unsupported Function Executed	The function that is not supported was executed.	The function that is not supported by the robot was executed.				○		O037
5401554B hex	Illegal IP Address Specification	The value of <i>IPAddr</i> input variable to a robot control instruction is not correct.	The length of the parameter list specified for the <i>IPAddr</i> input variable to an instruction was outside of the valid range.				○		O037

A-1-4 Errors in NJ Robotics Function

This section provides tables of the errors (events) that can occur in the NJ Robotics functions and robot instructions.

You can use the NJ Robotics functions and robot instructions with the NJ501-4□□□ CPU Unit and the NJ501-R□□□ CPU Unit. The unit version of the CPU Unit is 1.09 or later.

NJ Robotics Function

The upper four digits of the event code give the error code (ErrorID) for the instruction. For descriptions of an error code, refer to the description of the corresponding event code. For example, if the error code for the instruction is 16#5422, refer to the description for event code 54220000 hex.

The manual names are given below for the catalog numbers given in the Reference column of the event table.

Cat. No.	Manual name
W539	NJ-series NJ Robotics CPU Unit User's Manual

Event code	Event name	Meaning	Assumed cause	Level					Reference
				M a j	P r t	M i n	O b s	I n f o	
54220000 hex	Target Velocity Setting Out of Range	The parameter specified for the <i>Velocity</i> input variable to a motion control instruction is out of range.	<ul style="list-style-type: none"> Instruction input parameter exceeded the valid range of the input variable. 			○			W539
54230000 hex	Acceleration Setting Out of Range	The parameter specified for the <i>Acceleration</i> input variable to a motion control instruction is out of range.	<ul style="list-style-type: none"> Instruction input parameter exceeded the valid range of the input variable. 			○			W539
54240000 hex	Deceleration Setting Out of Range	The parameter specified for the <i>Deceleration</i> input variable to a motion control instruction is out of range.	<ul style="list-style-type: none"> Instruction input parameter exceeded the valid range of the input variable. 			○			W539
542B0000 hex	Buffer Mode Selection Out of Range	The parameter specified for the <i>BufferMode</i> input variable to a motion control instruction is out of range.	<ul style="list-style-type: none"> Instruction input parameter exceeded the valid range of the input variable. 			○			W539

Event code	Event name	Meaning	Assumed cause	Level					Reference
				M a j	P r t	M i n	O b s	I n f o	
542C0000 hex	Coordinate System Selection Out of Range	The parameter specified for the <i>CoordSystem</i> input variable to a motion control instruction is out of range.	<ul style="list-style-type: none"> Instruction input parameter exceeded the valid range of the input variable. 			○			W539
542E0000 hex	Direction Selection Out of Range	The parameter specified for the <i>Direction</i> input variable to a motion control instruction is out of range.	<ul style="list-style-type: none"> Instruction input parameter exceeded the valid range of the input variable. 			○			W539
54320000 hex	Transition Mode Selection Out of Range	The parameter specified for the <i>TransitionMode</i> input variable to a motion control instruction is out of range.	<ul style="list-style-type: none"> Instruction input parameter exceeded the valid range of the input variable. <i>_mcAborting</i> or <i>_mcBuffered</i> was specified for <i>BufferMode</i> and <i>_mcTMNone</i> was not specified for <i>TransitionMode</i>. 			○			W539
543B0000 hex	Motion Control Instruction Re-execution Disabled	An attempt was made to re-execute a motion control instruction that cannot be re-executed.	<ul style="list-style-type: none"> A motion control instruction that cannot be re-executed was re-executed. 			○			W539
543C0000 hex	Motion Control Instruction Multi-execution Disabled	Multiple functions that cannot be executed simultaneously were executed for the same target (MC common, axis, or axes group).	<ul style="list-style-type: none"> Multiple functions that cannot be executed simultaneously were executed for the same target (MC common, axis, or axes group). 			○			W539
543E0000 hex	Instruction Cannot Be Executed during Multi-axes Coordinated Control	<ul style="list-style-type: none"> A motion instruction was executed for an axis or an axes group that was in a coordinated multi-axes motion. A robot instruction that you cannot use for an axes group in a Group-Enable state was executed. 	<ul style="list-style-type: none"> A motion instruction was executed for an axis or an axes group that was in a coordinated multi-axes motion. The <i>MC_SetKinTransform</i> instruction was executed for an axes group in a GroupEnable state. 			○			W539

Event code	Event name	Meaning	Assumed cause	Level					Reference
				M a j	P r t	M i n	O b s	I n f o	
543F0000 hex	Multi-axes Coordinated Control Instruction Executed for Disabled Axes Group	A multi-axes coordinated control instruction was executed for an axes group that was in a GroupDisable state.	<ul style="list-style-type: none"> A multi-axes coordinated control instruction was executed for an axes group that was in the Axes Group Disabled state. One of the following instructions was executed for an axes group that was in a GroupDisable state. MC_MoveTimeAbsolute MC_SyncLinearConveyor MC_SyncOut MC_RobotJog 			○			W539
54410000 hex	Impossible Axis Operation Specified when the Servo is OFF	A motion instruction was executed for an axis for which the Servo is OFF.	<ul style="list-style-type: none"> A motion instruction was executed for an axis for which the Servo is OFF. A zero position preset was performed with the MC_Home or MC_HomeWithParameter instruction for an axis for which EtherCAT process data communications are not established. 			○			W539
54420000 hex	Composition Axis Stopped Error	A motion instruction was executed for an axes group while the MC_Stop instruction was being executed for a composition axis.	<ul style="list-style-type: none"> A motion instruction was executed for an axes group while the MC_Stop instruction was being executed for a composition axis. 			○			W539
54430000 hex	Motion Control Instruction Multi-execution Buffer Limit Exceeded	The number of motion control instructions that is buffered for Buffered or Blending Buffer Modes exceeded the buffer limit.	<ul style="list-style-type: none"> An axis instruction was executed when there was already a current instruction and a buffered instruction for the same axis. An axes group instruction was executed when there was already eight current instructions and buffered instructions for the same axis. 			○			W539
54570000 hex	Motion Control Instruction Re-execution Disabled (Axes Group Specification)	An attempt was made to change the parameter for the <i>AxesGroup</i> input variable when re-executing a motion control instruction. (This input variable cannot be changed when re-executing an instruction.)	<ul style="list-style-type: none"> A parameter for an input variable that cannot be changed for re-execution was changed. 			○			W539

Event code	Event name	Meaning	Assumed cause	Level					Reference
				M a j	P r t	M i n	O b s	I n f o	
54610000 hex	Illegal Axes Group Specification	The axes group specified for the <i>AxesGroup</i> input variable to a motion control instruction does not exist or is not a used group.	<ul style="list-style-type: none"> An axes group does not exist for the variable specified for the <i>AxesGroup</i> input variable to the instruction. The axes group specified for the <i>AxesGroup</i> input variable to the instruction is not specified as a used group. 			○			W539
54660000 hex	Instruction Execution Error with Undefined Home	High-speed homing, an interpolation instruction, or a robot instruction was executed when home was undefined.	<ul style="list-style-type: none"> High-speed homing was executed when home was undefined. An interpolation instruction was executed for an axes group that includes an axis with no defined home. One of the following robot instructions was executed for an axes group that includes a logical axis with no defined home. MC_SetKinTransform MC_MoveTimeAbsolute MC_SyncLinearConveyor MC_SyncOut MC_GroupMon MC_RobotJog 			○			W539
54780000 hex	Target Position Setting Out of Range	The parameter specified for the <i>Position</i> input variable to a motion control instruction is out of range.	<ul style="list-style-type: none"> Instruction input parameter exceeded the valid range of the input variable. The target position of a Rotary Mode axis is not within the ring setting range. 			○			W539
57050000 hex	Kinematics Unsupported Instruction	An attempt was made to execute an instruction that cannot be used for an axes group for which the kinematics transform was set.	<ul style="list-style-type: none"> One of the following instructions was executed for an axes group for which the kinematics transform was set. MC_MoveLinear MC_MoveLinearAbsolute MC_MoveLinearRelative MC_MoveCircular2D MC_ChangeAxesInGroup 			○			W539

Event code	Event name	Meaning	Assumed cause	Level					Reference
				M a j	P r t	M i n	O b s	I n f o	
57060000 hex	Axes Group Mismatch with Kinematics	The configuration elements of the specified axes group and the specified kinematics do not match.	<ul style="list-style-type: none"> The number of axes in the axes group and the number of axes in the specified robot (kinematics type) do not match. The count mode for axes in the axes group and the count mode for the specified robot (kinematics type) do not match. The display unit for axes in the axes group and the display unit for the specified robot (kinematics type) do not match. 			○			W539
57070000 hex	Kinematics Type Out of Range	<i>KinType</i> specified for the <i>KinTransform</i> input variable to a motion control instruction is out of range.	<ul style="list-style-type: none"> <i>KinType</i> is outside the setting range. 			○			W539
57080000 hex	Kinematics Parameter Out of Range	<i>KinParam</i> or <i>ExpansionParam</i> specified for the <i>KinTransform</i> input variable to a motion control instruction is out of range.	<ul style="list-style-type: none"> <i>KinParam</i> is outside the setting range. <i>ExpansionParam</i> is outside the setting range. 			○			W539
57090000 hex	Workspace Type Out of Range	<i>WorkspaceType</i> specified for the <i>Workspace</i> input variable to a motion control instruction is out of range.	<ul style="list-style-type: none"> <i>WorkspaceType</i> is outside the setting range. 			○			W539
570A0000 hex	Workspace Parameter Out of Range	<i>WorkspaceParam</i> specified for the <i>Workspace</i> input variable to a motion control instruction is out of range.	<ul style="list-style-type: none"> <i>WorkspaceParam</i> is outside the setting range. 			○			W539
570B0000 hex	Invalid Coordinate System Number	The coordinate system ID specified for the <i>CSID</i> input variable to a motion control instruction is out of range or not defined.	<ul style="list-style-type: none"> The coordinate system ID is outside the setting range. The specified coordinate system ID is not defined by the <i>MC_DefineCoordSystem</i> instruction. 			○			W539

Event code	Event name	Meaning	Assumed cause	Level					Reference
				M a j	P r t	M i n	O b s	I n f o	
570C0000 hex	Coordinate Transformation Parameter Out of Range	The coordinate transformation parameter <i>Pose</i> , which was specified for the <i>CoordTransform</i> input variable to a motion control instruction, is out of range.	<ul style="list-style-type: none"> The coordinate transformation parameter <i>Pose</i> is outside the setting range. 			○			W539
570D0000 hex	Transition parameters out of range	The Transition Parameters specified for the <i>TransitionParameter</i> input variable to a motion control instruction is out of range.	<ul style="list-style-type: none"> TransitionParameter is outside the setting range. 			○			W539
570F0000 hex	Cannot Calculate Kinematics	The inverse kinematics or direct kinematics cannot be calculated.	<ul style="list-style-type: none"> The kinematics parameter is outside the setting range. One of the robot axes (A0 to A2) is stopped at the position for which direct kinematics calculation cannot be performed. Inverse kinematics calculation cannot be performed for the target position specified in the machine coordinate system. 			○			W539
57100000 hex	Kinematics Transform Not Set	The kinematics transform is not set for the specified axes group.	<ul style="list-style-type: none"> The kinematics transform is not set for the axes group. 			○			W539
57110000 hex	Target Position Out of Range	The position parameter specified as variable for the <i>Position</i> is out of range.	<ul style="list-style-type: none"> Specified wrong value of Position input. 			○			W539
57120000 hex	Velocity Error Detection Value Out of Range	<i>MaxVelocity</i> specified for the <i>TrajData</i> input variable to a motion control instruction is out of range.	<ul style="list-style-type: none"> <i>MaxVelocity</i> is outside the setting range. 			○			W539
57130000 hex	Acceleration Error Detection Value Out of Range	<i>MaxAcceleration</i> specified for the <i>TrajData</i> input variable to a motion control instruction is out of range.	<ul style="list-style-type: none"> <i>MaxAcceleration</i> is outside the setting range. 			○			W539
57140000 hex	Trajectory Target Time Out of Range	<i>TrajTime</i> specified for the <i>TrajData</i> input variable to a motion control instruction is out of range.	<ul style="list-style-type: none"> <i>TrajTime</i> is outside the setting range. 			○			W539

Event code	Event name	Meaning	Assumed cause	Level					Reference
				M a j	P r t	M i n	O b s	I n f o	
57150000 hex	Trajectory Type Out of Range	<i>MoveTrajType</i> specified for the <i>TrajData</i> input variable to a motion control instruction is out of range.	<ul style="list-style-type: none"> <i>MoveTrajType</i> or <i>SyncTrajType</i> is outside the setting range. 			○			W539
57160000 hex	Trajectory Transition Out of Range	<i>TrajTransition</i> specified for the <i>TrajData</i> input variable to a motion control instruction is out of range.	<ul style="list-style-type: none"> <i>TrajTransition</i> is outside the setting range. 			○			W539
57170000 hex	Trajectory Travel Distance Out of Range	<i>TrajDistance</i> specified for the <i>TrajData</i> input variable to a motion control instruction is out of range.	<ul style="list-style-type: none"> <i>TrajDistance</i> is outside the setting range. 			○			W539
57190000 hex	Initial Workpiece Position Outside Workspace	The position of the workpiece specified for the <i>InitWorkpiecePosition</i> input variable to a motion control instruction is outside the workspace.	<ul style="list-style-type: none"> <i>InitWorkpiecePosition</i> is outside the workspace. 			○			W539
571A0000 hex	Invalid Conveyor Axis Specified	The axis specified for the <i>ConveyorAxis</i> input variable to a motion control instruction is not correct.	<ul style="list-style-type: none"> The specified axis is registered in the axes group which is specified for <i>AxesGroup</i>. The specified axis is an unused axis. The unit of the conveyor axis is incorrect. 			○			W539
571B0000 hex	Target Position Outside Workspace	The target position specified for the <i>Position</i> input variable to a motion control instruction is outside the workspace.	<ul style="list-style-type: none"> <i>Position</i> is outside the workspace. 			○			W539
571C0000 hex	Cannot Cancel Synchronization	The MC_SyncOut instruction cannot be executed.	<ul style="list-style-type: none"> The MC_SyncLinearConveyor instruction was not executed. The MC_SyncLinearConveyor instruction execution is in progress, but synchronization is not currently performed. 			○			W539
571E0000 hex	Too Many Kinematics	The number of kinematics exceeded the limit.	<ul style="list-style-type: none"> The number kinematics set by the MC_SetKinTransform instruction exceeded the limit. 			○			W539
571F0000 hex	Kinematics Initialization Error	Kinematics initialization failed.	<ul style="list-style-type: none"> One of the robot axes (A0 to A3) is stopped at the position for which direct kinematics calculation cannot be performed. 			○			W539

Event code	Event name	Meaning	Assumed cause	Level					Reference	
				M a j	P r t	M i n	O b s	I n f o		
57320000 hex	Invalid Tool Number	The tool ID specified for the <i>ToolID</i> input variable to a motion control instruction is out of range or not defined.	<ul style="list-style-type: none"> <i>ToolID</i> is outside the setting range. The specified tool ID is not defined by the MC_DefineTool-Transform instruction. 					○		W539
57330000 hex	Tool Parameter Out of Range	The transform parameter specified for the <i>ToolTransform</i> input variable to a motion control instruction is out of range.	<ul style="list-style-type: none"> The transform parameter is outside the setting range. 					○		W539
57340000 hex	Unsupported Transition Data	The transition mode specified for the <i>TransitionMode</i> input variable to a motion control instruction does not support the current instruction or the buffered instruction.	<ul style="list-style-type: none"> The parameters specified for the <i>TransitionParameter</i> input variable cannot be used for transition in the mode specified for the <i>TransitionMode</i> input variable. The trajectory data which is set for the buffered instruction cannot be used for transition in the mode specified for the <i>TransitionMode</i> input variable. 					○		W539
57360000 hex	Offset Not Allowed	During the MC_SyncLinearConveyor instruction execution, the offset function can be used only in Phase6.	<ul style="list-style-type: none"> The <i>EnableOffset</i> input variable changed to TRUE before the MC_SyncLinearConveyor instruction operation entered Phase6. 					○		W539
57370000 hex	Motion Control Instruction Multiexecution Disabled (Trajectory Type)	An input variable that cannot be changed was changed during multi-execution of instructions.	<ul style="list-style-type: none"> <i>MoveTrajType</i> or <i>SyncTrajType</i> for the current instruction do not match <i>MoveTrajType</i> or <i>SyncTrajType</i> for the next instruction executed with Buffered or Blending. 					○		W539
57390000 hex	Unsupported Transition Mode	The next instruction was executed with <i>TransitionMode</i> which does not support the combination of the current and next instructions.	<ul style="list-style-type: none"> The transition mode specified for the <i>TransitionMode</i> input variable to a motion control instruction does not support the combination of the current instruction and buffered instruction. 					○		W539
57440000 hex	Jog Mode Out of Range	The <i>JogMode</i> input variable to the MC_RobotJog instruction is out of range.	<ul style="list-style-type: none"> The <i>JogMode</i> input variable to the MC_RobotJog instruction is outside the setting range. 					○		W539

Event code	Event name	Meaning	Assumed cause	Level					Reference
				M a j	P r t	M i n	O b s	I n f o	
57450000 hex	Initial Workpiece Position Out of Range	The <i>InitWorkpiecePosition</i> input variable to the MC_SyncLinearConveyor instruction is out of range.	<ul style="list-style-type: none"> The <i>InitWorkpiecePosition</i> input variable to the MC_SyncLinearConveyor instruction is outside the setting range. 			○			W539
57460000 hex	Maximum Interpolation Velocity Out of Range	The <i>MaxVelocityTCP</i> input variable to the MC_SetKinTransform instruction is out of range.	<ul style="list-style-type: none"> The <i>MaxVelocityTCP</i> input variable to the MC_SetKinTransform instruction is outside the setting range. 			○			W539
57470000 hex	Maximum Interpolation Acceleration Out of Range	The <i>MaxAccelerationTCP</i> input variable to the MC_SetKinTransform instruction is out of range.	<ul style="list-style-type: none"> The <i>MaxAccelerationTCP</i> input variable to the MC_SetKinTransform instruction is outside the setting range. 			○			W539
57480000 hex	Maximum Interpolation Deceleration Out of Range	The <i>MaxDecelerationTCP</i> input variable to the MC_SetKinTransform instruction is out of range.	<ul style="list-style-type: none"> The <i>MaxDecelerationTCP</i> input variable to the MC_SetKinTransform instruction is outside the setting range. 			○			W539
64430000 hex	Positive Limit Input	An instruction was executed for a motion in the positive direction when the positive limit input was ON.	<ul style="list-style-type: none"> An instruction for a motion in the positive direction was executed when the positive limit input was ON, or an instruction for a motion with no direction specification was executed when the positive limit input was ON. An axes group motion control instruction was executed when the positive limit input was ON. 			○			W539
64440000 hex	Negative Limit Input	An instruction for a motion in the negative direction was executed when the negative limit input was ON.	<ul style="list-style-type: none"> An instruction for a motion in the negative direction was executed when the negative limit input was ON, or an instruction for a motion with no direction specification was executed when the negative limit input was ON. An axes group motion control instruction was executed when the negative limit input was ON. 			○			W539



Event code	Event name	Meaning	Assumed cause	Level					Reference
				M a j	P r t	M i n	O b s	I n f o	
64590000 hex	Home Undefined during Coordinated Motion	Home of the logical axis became undefined during axes group motion or while decelerating to a stop.	<ul style="list-style-type: none"> The command position or actual position overflowed or underflowed for a logical axis in an axes group motion or a logical axis that was decelerating to a stop and the home definition was lost. A slave communications error occurred for a logical axis and home became undefined during axes group motion or while decelerating to a stop. A slave for a logical axis left the network or was disabled and home became undefined during axes group motion or while decelerating to a stop. 						W539
645A0000 hex	Maximum Interpolation Velocity Error	The command velocity exceeded the maximum interpolation velocity specified for the <i>MaxVelocityTCP</i> input variable to the MC_SetKinTransform instruction.	<ul style="list-style-type: none"> The trajectory data for the current instruction is incorrect. The maximum interpolation velocity specified for the <i>MaxVelocityTCP</i> input variable to the MC_SetKinTransform instruction is incorrect or too low. 						W539
645B0000 hex	Maximum Interpolation Acceleration Error	The command acceleration rate exceeded the maximum interpolation acceleration specified for the <i>MaxAccelerationTCP</i> input variable to the MC_SetKinTransform instruction.	<ul style="list-style-type: none"> The trajectory data for the current instruction is incorrect. The maximum interpolation acceleration specified for the <i>MaxAccelerationTCP</i> input variable to the MC_SetKinTransform instruction is incorrect or too low. 						W539
645C0000 hex	Maximum Interpolation Deceleration Error	The command deceleration rate exceeded the maximum interpolation deceleration specified for the <i>MaxDecelerationTCP</i> input variable to the MC_SetKinTransform instruction.	<ul style="list-style-type: none"> The trajectory data for the current instruction is incorrect. The maximum interpolation deceleration specified for the <i>MaxDecelerationTCP</i> input variable to the MC_SetKinTransform instruction is incorrect or too low. 						W539
67000000 hex	Command Position Outside Workspace	The command position is outside the workspace.	<ul style="list-style-type: none"> The specified trajectory data is incorrect. 						W539

Event code	Event name	Meaning	Assumed cause	Level					Reference
				M a j	P r t	M i n	O b s	I n f o	
67010000 hex	Current Position Outside Workspace	The current position was outside the workspace when an instruction was executed.	<ul style="list-style-type: none"> The current position was outside the workspace when one of the following instructions was executed. MC_MoveTimeAbsolute MC_SyncLinearConveyor MC_SyncOut MC_RobotJog 			○			W539
67020000 hex	Workpiece Synchronization Excessive Following Error	The robot could not catch up the workpiece on the conveyor.	<ul style="list-style-type: none"> The conveyor position was changed before the robot reached the workpiece. The conveyor current position is incorrect. 			○			W539
67030000 hex	Velocity Error Detection	The command velocity exceeded <i>MaxVelocity</i> specified for the <i>TrajData</i> input variable to a motion control instruction.	<ul style="list-style-type: none"> The combination of parameters specified for the <i>TrajData</i> input variable caused a too high command velocity. The parameters specified for the <i>TrajData</i> input variable are incorrect. <i>MaxVelocity</i> is too low. 			○			W539
67040000 hex	Acceleration Error Detection	The command acceleration rate exceeded the <i>MaxAcceleration</i> specified for the <i>TrajData</i> input variable to a motion control instruction.	<ul style="list-style-type: none"> The combination of parameters specified for the <i>TrajData</i> input variable caused a too high command acceleration rate. The parameters specified for the <i>TrajData</i> input variable are incorrect. <i>MaxAcceleration</i> is too low. 			○			W539
67050000 hex	Command Current Velocity Limit Exceeded	The command current velocity exceeded the axis maximum velocity.	<ul style="list-style-type: none"> The axis maximum velocity was exceeded. 			○			W539
74300000 hex	Axes Group Composition Axis Error	An error occurred for an axis in an axes group.	<ul style="list-style-type: none"> An error occurred for an axis in an axes group that was in motion. 			○			W539
77000000 hex	Conveyor Axis Position Read Error	The MC_SyncLinearConveyor instruction cannot be executed due to a conveyor axis position error.	<ul style="list-style-type: none"> EtherCAT process data communications are not established for the conveyor axis. The slave of the conveyor axis was disconnected. An Absolute Encoder Current Position Calculation Failed error (64580000 hex) was detected for the conveyor axis. 			○			W539

Event code	Event name	Meaning	Assumed cause	Level					Reference
				M a j	P r t	M i n	O b s	I n f o	
94230000 hex	Transition Parameter Adjusted	The specified <i>TransitionParameter</i> input variable was adjusted before transition started.	<ul style="list-style-type: none"> The transition start condition specified for <i>TransitionParameter</i> input variable for multi-execution of instructions was already exceeded by the current instruction. 				○		W539

A

Robot Instructions

The manual names are given below for the catalog numbers given in the Reference column of the event table.

Cat. No.	Manual name
W539	NJ-series NJ Robotics CPU Unit User's Manual

Event code	Event name	Meaning	Assumed cause	Level					Reference
				M a j	P r t	M i n	O b s	I n f o	
54015422 hex	Target Velocity Setting Out of Range	The parameter specified for the <i>Velocity</i> input variable to a motion control instruction is out of range.	<ul style="list-style-type: none"> Instruction input parameter exceeded the valid range of the input variable. 				○		W539
54015423 hex	Acceleration Setting Out of Range	The parameter specified for the <i>Acceleration</i> input variable to a motion control instruction is out of range.	<ul style="list-style-type: none"> Instruction input parameter exceeded the valid range of the input variable. 				○		W539
54015424 hex	Deceleration Setting Out of Range	The parameter specified for the <i>Deceleration</i> input variable to a motion control instruction is out of range.	<ul style="list-style-type: none"> Instruction input parameter exceeded the valid range of the input variable. 				○		W539
5401542B hex	Buffer Mode Selection Out of Range	The parameter specified for the <i>BufferMode</i> input variable to a motion control instruction is out of range.	<ul style="list-style-type: none"> Instruction input parameter exceeded the valid range of the input variable. 				○		W539
5401542C hex	Coordinate System Selection Out of Range	The parameter specified for the <i>CoordSystem</i> input variable to a motion control instruction is out of range.	<ul style="list-style-type: none"> Instruction input parameter exceeded the valid range of the input variable. 				○		W539
5401542E hex	Direction Selection Out of Range	The parameter specified for the <i>Direction</i> input variable to a motion control instruction is out of range.	<ul style="list-style-type: none"> Instruction input parameter exceeded the valid range of the input variable. 				○		W539

Event code	Event name	Meaning	Assumed cause	Level					Reference
				M a j	P r t	M i n	O b s	I n f o	
54015432 hex	Transition Mode Selection Out of Range	The parameter specified for the <i>TransitionMode</i> input variable to a motion control instruction is out of range.	<ul style="list-style-type: none"> Instruction input parameter exceeded the valid range of the input variable. <i>_mcAborting</i> or <i>_mcBuffered</i> was specified for <i>BufferMode</i> and <i>_mcTMNone</i> was not specified for <i>TransitionMode</i>. 					○	W539
5401543B hex	Motion Control Instruction Re-execution Disabled	An attempt was made to re-execute a motion control instruction that cannot be re-executed.	<ul style="list-style-type: none"> A motion control instruction that cannot be re-executed was re-executed. 					○	W539
5401543C hex	Motion Control Instruction Multi-execution Disabled	Multiple functions that cannot be executed simultaneously were executed for the same target (MC common, axis, or axes group).	<ul style="list-style-type: none"> Multiple functions that cannot be executed simultaneously were executed for the same target (MC common, axis, or axes group). 					○	W539
5401543E hex	Instruction Cannot Be Executed during Multi-axes Coordinated Control	<ul style="list-style-type: none"> A motion instruction was executed for an axis or an axes group that was in a coordinated multi-axes motion. A robot instruction that you cannot use for an axes group in a GroupEnable state was executed. 	<ul style="list-style-type: none"> A motion instruction was executed for an axis or an axes group that was in a coordinated multi-axes motion. The <i>MC_SetKinTransform</i> instruction was executed for an axes group in a GroupEnable state. 					○	W539
5401543F hex	Multi-axes Coordinated Control Instruction Executed for Disabled Axes Group	A multi-axes coordinated control instruction was executed for an axes group that was in a GroupDisable state.	<ul style="list-style-type: none"> A multi-axes coordinated control instruction was executed for an axes group that was in a GroupDisable state. One of the following instructions was executed for an axes group that was in a GroupDisable state. <i>MC_MoveTimeAbsolute</i> <i>MC_SyncLinearConveyor</i> <i>MC_SyncOut</i> <i>MC_RobotJog</i> 					○	W539

Event code	Event name	Meaning	Assumed cause	Level					Reference
				M a j	P r t	M i n	O b s	I n f o	
54015441 hex	Impossible Axis Operation Specified when the Servo is OFF	A motion instruction was executed for an axis for which the Servo is OFF.	<ul style="list-style-type: none"> A motion instruction was executed for an axis for which the Servo is OFF. A zero position preset was performed with the MC_Home or MC_HomeWithParameter instruction for an axis for which EtherCAT process data communications are not established. 				○		W539
54015442 hex	Composition Axis Stopped Error	A motion instruction was executed for an axes group while the MC_Stop instruction was being executed for a composition axis.	<ul style="list-style-type: none"> A motion instruction was executed for an axes group while the MC_Stop instruction was being executed for a composition axis. 				○		W539
54015443 hex	Motion Control Instruction Multi-execution Buffer Limit Exceeded	The number of motion control instructions that is buffered for Buffered or Blending Buffer Modes exceeded the buffer limit.	<ul style="list-style-type: none"> An axis instruction was executed when there was already a current instruction and a buffered instruction for the same axis. An axes group instruction was executed when there was already eight current instructions and buffered instructions for the same axis. 				○		W539
54015461 hex	Illegal Axes Group Specification	The axes group specified for the <i>AxesGroup</i> input variable to a motion control instruction does not exist or is not a used axes group.	<ul style="list-style-type: none"> An axes group does not exist for the variable specified for the <i>AxesGroup</i> input variable to the instruction. The axes group specified for the <i>AxesGroup</i> input variable to the instruction is not specified as a used axes group. 				○		W539
54015466 hex	Instruction Execution Error with Undefined Home	High-speed homing, an interpolation instruction, or a robot instruction was executed when home was undefined.	<ul style="list-style-type: none"> High-speed homing was executed when home was undefined. An interpolation instruction was executed for an axes group that includes an axis with no defined home. One of the following robot instructions was executed for an axes group that includes a logical axis with no defined home. MC_SetKinTransform MC_MoveTimeAbsolute MC_SyncLinearConveyor MC_SyncOut MC_GroupMon MC_RobotJog 				○		W539

Event code	Event name	Meaning	Assumed cause	Level					Reference
				M a j	P r t	M i n	O b s	I n f o	
54015478 hex	Target Position Setting Out of Range	The parameter specified for the <i>Position</i> input variable to a motion control instruction is out of range.	<ul style="list-style-type: none"> Instruction input parameter exceeded the valid range of the input variable. The target position of a Rotary Mode axis is not within the ring setting range. 				○		W539
54015706 hex	Axes Group Mismatch with Kinematics	The configuration elements of the specified axes group and the specified kinematics do not match.	<ul style="list-style-type: none"> The number of axes in the axes group and the number of axes in the specified robot (kinematics type) do not match. The count mode for axes in the axes group and the count mode for the specified robot (kinematics type) do not match. The display unit for axes in the axes group and the display unit for the specified robot (kinematics type) do not match. 				○		W539
54015707 hex	Kinematics Type Out of Range	<i>KinType</i> specified for the <i>KinTransform</i> input variable to a motion control instruction is out of range.	<ul style="list-style-type: none"> <i>KinType</i> is outside the setting range. 				○		W539
54015708 hex	Kinematics Parameter Out of Range	<i>KinParam</i> or <i>ExpansionParam</i> specified for the <i>KinTransform</i> input variable to a motion control instruction is out of range.	<ul style="list-style-type: none"> <i>KinParam</i> is outside the setting range. <i>ExpansionParam</i> is outside the setting range. 				○		W539
54015709 hex	Workspace Type Out of Range	<i>WorkspaceType</i> specified for the <i>Workspace</i> input variable to a motion control instruction is out of range.	<ul style="list-style-type: none"> <i>WorkspaceType</i> is outside the setting range. 				○		W539
5401570A hex	Workspace Parameter Out of Range	<i>WorkspaceParam</i> specified for the <i>Workspace</i> input variable to a motion control instruction is out of range.	<ul style="list-style-type: none"> <i>WorkspaceParam</i> is outside the setting range. 				○		W539
5401570B hex	Invalid Coordinate System Number	The coordinate system ID specified for the <i>CSID</i> input variable to a motion control instruction is out of range or not defined.	<ul style="list-style-type: none"> The coordinate system ID is outside the setting range. The specified coordinate system ID is not defined by the <i>MC_DefineCoordSystem</i> instruction. 				○		W539

Event code	Event name	Meaning	Assumed cause	Level					Reference
				M a j	P r t	M i n	O b s	I n f o	
5401570C hex	Coordinate Transformation Parameter Out of Range	The coordinate transformation parameter <i>Pose</i> , which was specified for the <i>CoordTransform</i> input variable to a motion control instruction, is out of range.	<ul style="list-style-type: none"> The coordinate transformation parameter <i>Pose</i> is outside the setting range. 				○		W539
5401570D hex	Transition parameters out of range	The Transition Parameters specified for the <i>TransitionParameter</i> input variable to a motion control instruction is out of range.	<ul style="list-style-type: none"> TransitionParameter is outside the setting range. 				○		W539
54015710 hex	Kinematics Transform Not Set	The kinematics transform is not set for the specified axes group.	<ul style="list-style-type: none"> The kinematics transform is not set for the axes group. 				○		W539
54015711 hex	Target Position Out of Range	The position parameter specified as variable for the <i>Position</i> is out of range.	<ul style="list-style-type: none"> Specified wrong value of Position input. 				○		W539
54015712 hex	Velocity Error Detection Value Out of Range	<i>MaxVelocity</i> specified for the <i>TrajData</i> input variable to a motion control instruction is out of range.	<ul style="list-style-type: none"> <i>MaxVelocity</i> is outside the setting range. 				○		W539
54015713 hex	Acceleration Error Detection Value Out of Range	<i>MaxAcceleration</i> specified for the <i>TrajData</i> input variable to a motion control instruction is out of range.	<ul style="list-style-type: none"> <i>MaxAcceleration</i> is outside the setting range. 				○		W539
54015714 hex	Trajectory Target Time Out of Range	<i>TrajTime</i> specified for the <i>TrajData</i> input variable to a motion control instruction is out of range.	<ul style="list-style-type: none"> <i>TrajTime</i> is outside the setting range. 				○		W539
54015715 hex	Trajectory Type Out of Range	<i>MoveTrajType</i> specified for the <i>TrajData</i> input variable to a motion control instruction is out of range.	<ul style="list-style-type: none"> <i>MoveTrajType</i> or <i>SyncTrajType</i> is outside the setting range. 				○		W539
54015716 hex	Trajectory Transition Out of Range	<i>TrajTransition</i> specified for the <i>TrajData</i> input variable to a motion control instruction is out of range.	<ul style="list-style-type: none"> <i>TrajTransition</i> is outside the setting range. 				○		W539

Event code	Event name	Meaning	Assumed cause	Level					Reference
				M a j	P r t	M i n	O b s	I n f o	
54015717 hex	Trajectory Travel Distance Out of Range	<i>TrajDistance</i> specified for the <i>TrajData</i> input variable to a motion control instruction is out of range.	<ul style="list-style-type: none"> <i>TrajDistance</i> is outside the setting range. 				○		W539
54015719 hex	Initial Workpiece Position Outside Workspace	The position of the workpiece specified for the <i>InitWorkpiecePosition</i> input variable to a motion control instruction is outside the workspace.	<ul style="list-style-type: none"> <i>InitWorkpiecePosition</i> is outside the workspace. 				○		W539
5401571A hex	Invalid Conveyor Axis Specified	The axis specified for the <i>ConveyorAxis</i> input variable to a motion control instruction is not correct.	<ul style="list-style-type: none"> The specified axis is registered in the axes group which is specified for <i>AxesGroup</i>. The specified axis is an unused axis. The unit of the conveyor axis is incorrect. 				○		W539
5401571B hex	Target Position Outside Workspace	The target position specified for the <i>Position</i> input variable to a motion control instruction is outside the workspace.	<ul style="list-style-type: none"> <i>Position</i> is outside the workspace. 				○		W539
5401571C hex	Cannot Cancel Synchronization	The MC_SyncOut instruction cannot be executed.	<ul style="list-style-type: none"> The MC_SyncLinearConveyor instruction was not executed. The MC_SyncLinearConveyor instruction execution is in progress, but synchronization is not currently performed. 				○		W539
5401571E hex	Too Many Kinematics	The number of kinematics exceeded the limit.	<ul style="list-style-type: none"> The number kinematics set by the MC_SetKinTransform instruction exceeded the limit. 				○		W539
5401571F hex	Kinematics Initialization Error	Kinematics initialization failed.	<ul style="list-style-type: none"> One of the robot axes (A0 to A3) is stopped at the position for which direct kinematics calculation cannot be performed. 				○		W539
54015732 hex	Invalid Tool Number	The tool ID specified for the <i>ToolID</i> input variable to a motion control instruction is out of range or not defined.	<ul style="list-style-type: none"> <i>ToolID</i> is outside the setting range. The specified tool ID is not defined by the MC_DefineToolTransform instruction. 				○		W539
54015733 hex	Tool Parameter Out of Range	The transform parameter specified for the <i>ToolTransform</i> input variable to a motion control instruction is out of range.	<ul style="list-style-type: none"> The transform parameter is outside the setting range. 				○		W539

Event code	Event name	Meaning	Assumed cause	Level					Reference
				M a j	P r t	M i n	O b s	I n f o	
54015736 hex	Offset Not Allowed	During the MC_SyncLinearConveyor instruction execution, the offset function can be used only in Phase6.	<ul style="list-style-type: none"> The <i>EnableOffset</i> input variable changed to TRUE before the MC_SyncLinearConveyor instruction operation entered Phase6. 				○		W539
54015744 hex	Jog Mode Out of Range	The <i>JogMode</i> input variable to the MC_RobotJog instruction is out of range.	<ul style="list-style-type: none"> The <i>JogMode</i> input variable to the MC_RobotJog instruction is outside the setting range. 				○		W539
54015745 hex	Initial Workpiece Position Out of Range	The <i>InitWorkpiecePosition</i> input variable to the MC_SyncLinearConveyor instruction is out of range.	<ul style="list-style-type: none"> The <i>InitWorkpiecePosition</i> input variable to the MC_SyncLinearConveyor instruction is outside the setting range. 				○		W539
54015746 hex	Maximum Interpolation Velocity Out of Range	The <i>MaxVelocityTCP</i> input variable to the MC_SetKinTransform instruction is out of range.	<ul style="list-style-type: none"> The <i>MaxVelocityTCP</i> input variable to the MC_SetKinTransform instruction is outside the setting range. 				○		W539
54015747 hex	Maximum Interpolation Acceleration Out of Range	The <i>MaxAccelerationTCP</i> input variable to the MC_SetKinTransform instruction is out of range.	<ul style="list-style-type: none"> The <i>MaxAccelerationTCP</i> input variable to the MC_SetKinTransform instruction is outside the setting range. 				○		W539
54015748 hex	Maximum Interpolation Deceleration Out of Range	The <i>MaxDecelerationTCP</i> input variable to the MC_SetKinTransform instruction is out of range.	<ul style="list-style-type: none"> The <i>MaxDecelerationTCP</i> input variable to the MC_SetKinTransform instruction is outside the setting range. 				○		W539
54016443 hex	Positive Limit Input	An instruction was executed for a motion in the positive direction when the positive limit input was ON.	<ul style="list-style-type: none"> An instruction for a motion in the positive direction was executed when the positive limit input was ON, or an instruction for a motion with no direction specification was executed when the positive limit input was ON. An axes group motion control instruction was executed when the positive limit input was ON. 				○		W539



Event code	Event name	Meaning	Assumed cause	Level					Reference
				M a j	P r t	M i n	O b s	I n f o	
54016444 hex	Negative Limit Input	An instruction for a motion in the negative direction was executed when the negative limit input was ON.	<ul style="list-style-type: none"> An instruction for a motion in the negative direction was executed when the negative limit input was ON, or an instruction for a motion with no direction specification was executed when the negative limit input was ON. An axes group motion control instruction was executed when the negative limit input was ON. 				○		W539
54016701 hex	Current Position Outside Workspace	The current position was outside the workspace when an instruction was executed.	<ul style="list-style-type: none"> The current position was outside the workspace when one of the following instructions was executed. MC_MoveTimeAbsolute MC_SyncLinearConveyor MC_SyncOut MC_RobotJog 				○		W539

A-1-5 Errors in the CNC Function

This section provides tables of the errors (events) that can occur in the CNC functions and CNC instructions.

You can use the CNC functions and CNC instructions with an NJ501-5300 Controller. The unit version of the CPU Unit is 1.16 or later.

CNC Function

The manual names are given below for the catalog numbers given in the Reference column of the event table.

Cat. No.	Manual name
O030	NJ/NY-series NC Integrated Controller User's Manual

Event code	Event name	Meaning	Assumed cause	Level					Reference
				M a j	P r t	M i n	O b s	I n f o	
47810000 hex	CNC Parameter Setting Invalid	A fatal error was detected during setting of the CNC Function Module.	<ul style="list-style-type: none"> The system failed to transfer the CNC parameter setting. Otherwise, an error occurred in the software. 	○					O030
17800000 hex	CNC Parameter Setting Error	The CNC parameters that were saved in non-volatile memory are missing.	<ul style="list-style-type: none"> The power supply to the Controller was interrupted or communications with the Sysmac Studio were disconnected while downloading the CNC parameter settings or clearing memory. Non-volatile memory failure 		○				O030
17810000 hex	Absolute Encoder Home Offset Read Error	The absolute encoder current position that is retained during power interruptions was lost.	<ul style="list-style-type: none"> When the retained variables are backed up with a battery, this event indicates that the life of the battery in the CPU Unit has expired. Backup memory failure 		○				O030
17820000 hex	CNC Motor Compensation Table Read Error	The CNC motor compensation table that was saved in non-volatile memory is missing.	<ul style="list-style-type: none"> The power supply to the Controller was interrupted or communications with the Sysmac Studio were disconnected while downloading the CNC parameter settings or clearing memory. Non-volatile memory failure 		○				O030
37800000 hex	Required Process Data Object Not Set	The object that is required for the assigned axis type in the CNC motor parameter settings is not allocated to PDO.	<ul style="list-style-type: none"> The required PDOs are not mapped when the assigned axis type in the CNC motor parameter settings is set to a servo axis or encoder axis. Non-volatile memory failure 		○				O030

A

Event code	Event name	Meaning	Assumed cause	Level					Reference
				M a j	P r t	M i n	O b s	I n f o	
47800000 hex	CNC Initiali- zation Error	A fatal error occurred in the system and prevented initializa- tion of the CNC Func- tion Module.	• Hardware failure		○				O030
77800000 hex	CNC Control Period Ex- ceeded	The primary periodic task processing has not been completed within two control cy- cles.	• The processing load in the pri- mary periodic task is too heavy.		○				O030
37810000 hex	Process Da- ta Object Setting Miss- ing	The PDO mapping is not correct.	• The relevant instruction was executed for a device that does not have an object that supports the instruction.			○			O030
56000000 hex	Illegal CNC Coordinate System Specification	The CNC coordinate system specified for the <i>Coord</i> in-out vari- able to a CNC in- struction does not exist.	• CNC coordinate system does not exist for the variable speci- fied for the <i>Coord</i> in-out vari- able to the instruction.			○			O030
56010000 hex	Deceleration Setting Out of Range	The parameter speci- fied for the <i>Deceleration</i> input variable to a CNC in- struction is out of range.	• Instruction input parameter ex- ceeded the valid range of the input variable.			○			O030
56020000 hex	Jerk Setting Out of Range	The parameter speci- fied for the <i>Jerk</i> input variable to a CNC in- struction is out of range.	• Instruction input parameter ex- ceeded the valid range of the input variable.			○			O030
56030000 hex	CNC Instruc- tion Re-exe- cution Disa- bled	A CNC instruction that cannot be re- executed was re-exe- cuted.	• A CNC instruction that cannot be re-executed was re-execut- ed.			○			O030
56040000 hex	CNC Multi- execution Disabled	Multiple functions that cannot be executed simultaneously were executed for the same target (CNC co- ordinate system).	• Multiple functions that cannot be executed simultaneously were executed for the same target (CNC coordinate sys- tem). • The CNC_LoadProgramFile in- struction was executed when any of CNC coordinate system was Executing (Executing) or Hold (Holding).			○			O030

Event code	Event name	Meaning	Assumed cause	Level					Reference
				M a j	P r t	M i n	O b s	I n f o	
56050000 hex	Unassigned Logical CNC Motor Number Specified	The CNC motor of the parameter specified for the <i>LogicalMotorNo</i> input variable to the CNC instruction is not assigned.	<ul style="list-style-type: none"> The logical CNC motor number for which the CNC motor is not assigned to the <i>LogicalMotorNo</i> input variable to the CNC instruction was specified, and the instruction was executed. 			○			O030
56060000 hex	Logical CNC Motor Number Out of Range	The parameter specified for the <i>LogicalMotorNo</i> input variable to a CNC instruction is out of range.	<ul style="list-style-type: none"> Instruction input parameter exceeded the valid range of the input variable. 			○			O030
56070000 hex	Target Position Setting Out of Range	The parameter specified for the <i>Position</i> input variable to a CNC instruction is out of range.	<ul style="list-style-type: none"> Instruction input parameter exceeded the valid range of the input variable. Or, there was an overflow/underflow in the target position. 			○			O030
56080000 hex	Impossible CNC Motor Operation Specified when the Servo is OFF	An operation instruction was executed for the CNC motor for which the Servo is OFF.	<ul style="list-style-type: none"> Home was preset with the CNC_Home or CNC_Home-WithParameter instruction for an axis for which EtherCAT process data communications are not established. 			○			O030
56090000 hex	Target Velocity Setting Out of Range	The parameter specified for the <i>Velocity</i> input variable to a CNC instruction is out of range.	<ul style="list-style-type: none"> Instruction input parameter exceeded the valid range of the input variable. 			○			O030
560A0000 hex	Acceleration/Deceleration Setting Out of Range	The parameter specified for the <i>Acceleration</i> input variable to a CNC instruction is out of range.	<ul style="list-style-type: none"> Instruction input parameter exceeded the valid range of the input variable. 			○			O030
560B0000 hex	Travel Mode Selection Out of Range	The parameter specified for the <i>MoveMode</i> input variable to a CNC instruction is out of range.	<ul style="list-style-type: none"> Instruction input parameter exceeded the valid range of the input variable. 			○			O030
560C0000 hex	Immediate Stop Instruction Executed	An Immediate Stop (CNC_CoordImmediateStop) instruction was executed.	<ul style="list-style-type: none"> An Immediate Stop instruction was executed. 			○			O030

Event code	Event name	Meaning	Assumed cause	Level					Reference
				M a j	P r t	M i n	O b s	I n f o	
560D0000 hex	Parameter Selection Out of Range	The parameter specified for the <i>ParameterNumber</i> input variable to a CNC instruction is out of range.	<ul style="list-style-type: none"> Instruction input parameter exceeded the valid range of the input variable. 			○			O030
560E0000 hex	CNC Parameter Setting Read/Write Setting Value Out of Range	The parameter specified for the <i>SettingValue</i> in-out variable to a CNC instruction is out of range.	<ul style="list-style-type: none"> Instruction input parameter exceeded the valid range of the in-out variable. 			○			O030
560F0000 hex	CNC Parameter Setting Read/Write Target Out of Range	The parameter specified for the <i>Target</i> in-out variable to a CNC instruction is out of range.	<ul style="list-style-type: none"> Instruction input parameter exceeded the valid range of the in-out variable. 			○			O030
56100000 hex	Cycle Start Error with Undefined Home	A cycle start was executed for a CNC coordinate system including the positioning axis with no defined home.	<ul style="list-style-type: none"> A cycle start was executed for a CNC coordinate system including the positioning axis with no defined home. 			○			O030
56110000 hex	Homing Parameter Setting Out of Range	The parameter specified for the <i>HomingParameter</i> in-out variable of the CNC instruction is out of range.	<ul style="list-style-type: none"> Instruction input parameter exceeded the valid range of the in-out variable. 			○			O030
56120000 hex	M Code Number Out of Range	The parameter specified for the <i>MCodeNo</i> input variable to a CNC instruction is out of range.	<ul style="list-style-type: none"> Instruction input parameter exceeded the valid range of the input variable. 			○			O030
56130000 hex	CNC Instruction Re-execution Disabled (CNC Coordinate System Specification)	An attempt was made to change the parameter for the <i>Coord</i> in-out variable when re-executing a CNC instruction. (This in-out variable cannot be changed when re-executing an instruction.)	<ul style="list-style-type: none"> A parameter for an in-out variable that cannot be changed for re-execution was changed. 			○			O030

Event code	Event name	Meaning	Assumed cause	Level					Reference
				M a j	P r t	M i n	O b s	I n f o	
56140000 hex	CNC Instruction Re-execution Disabled (Logical CNC Motor Number)	An attempt was made to change the parameter for the <i>LogicalMotorNo</i> input variable when re-executing a CNC instruction. (This input variable cannot be changed when re-executing an instruction.)	<ul style="list-style-type: none"> A parameter for an input variable that cannot be changed for re-execution was changed. 			○			O030
56150000 hex	Illegal NC Program	An error was detected in the NC program transferred from Sysmac Studio.	<ul style="list-style-type: none"> NC program transfer processing failed. 			○			O030
56160000 hex	Cycle Start Multi-execution Disabled	A cycle start was executed multiple times for the same target (CNC coordinate system).	<ul style="list-style-type: none"> A cycle start was executed while the CNC coordinate system is Executing (Executing), MovingOnHold (Manual Operation While Holding), or Moving (Moving). 			○			O030
56170000 hex	Impossible CNC Motor Cycle Start Specified when the Servo is OFF	A cycle start was executed for a CNC coordinate system including the CNC motor for which the Servo is OFF.	<ul style="list-style-type: none"> A cycle start was executed for the CNC motor for which Servo is turned OFF. 			○			O030
56180000 hex	Illegal NC Program Number Specification	The NC program specified for <i>ProgramNo</i> in the <i>ControlInputs</i> in-out variable to the CNC_CoordControl instruction is not loaded.	<ul style="list-style-type: none"> A cycle start was executed after an unloaded NC program is specified for <i>ProgramNo</i> in the <i>ControlInputs</i> in-out variable to the CNC_CoordControl instruction. 			○			O030
56190000 hex	Illegal Back Trace Specification	A cycle start was executed when the CNC coordinate system is Standby (Standby) while <i>BackTrace</i> in the <i>ControlInputs</i> in-out variable to the CNC_CoordControl instruction is set to TRUE.	<ul style="list-style-type: none"> A cycle start was executed when the CNC coordinate system is Standby (Standby) while <i>BackTrace</i> in the <i>ControlInputs</i> in-out variable to the CNC_CoordControl instruction is set to TRUE. 			○			O030
56250000 hex	Illegal CNC Motor Specification	The CNC motor specified for the <i>Target</i> input variable to a CNC instruction does not exist.	<ul style="list-style-type: none"> A CNC motor does not exist for the variable specified for the <i>Target</i> input variable to the instruction. 			○			O030

Event code	Event name	Meaning	Assumed cause	Level					Reference
				M a j	P r t	M i n	O b s	I n f o	
56260000 hex	Illegal CNC Motor Compensation Table Specification	The CNC motor compensation table specified for the <i>Target</i> input variable to a CNC instruction does not exist.	<ul style="list-style-type: none"> A CNC motor compensation table does not exist for the variable specified for the <i>Target</i> input variable to the instruction. 			○			O030
56290000 hex	NC Program Capacity Exceeded	Loading failed because the NC program downloaded from Sysmac Studio exceeded the maximum capacity.	<ul style="list-style-type: none"> The NC program that has a capacity above the maximum was downloaded from Sysmac Studio. 			○			O030
562A0000 hex	Skew Control Mode Out of Range	The parameter specified for the <i>SkewMode</i> input variable to a CNC instruction is out of range.	<ul style="list-style-type: none"> Instruction input parameter exceeded the valid range of the input variable. 			○			O030
562B0000 hex	Offset Value Setting Out of Range	The parameter specified for the <i>OffsetValue</i> input variable to a CNC instruction is out of range.	<ul style="list-style-type: none"> Instruction input parameter exceeded the valid range of the input variable. 			○			O030
67800000 hex	Immediate Stop Input	The immediate stop input turned ON.	<ul style="list-style-type: none"> An immediate stop input signal was detected. The immediate stop input signal is not connected correctly or the logic setting for the immediate stop input is wrong. 			○			O030
67810000 hex	Positive Limit Input Detected	The positive limit input turned ON.	<ul style="list-style-type: none"> A positive limit input signal was detected. The positive limit input signal is not connected correctly or the logic setting for the positive limit input is wrong. 			○			O030
67820000 hex	Negative Limit Input Detected	The negative limit input turned ON.	<ul style="list-style-type: none"> A negative limit input signal was detected. The negative limit input signal is not connected correctly or the logic setting for the negative limit input is wrong. 			○			O030

Event code	Event name	Meaning	Assumed cause	Level					Reference
				M a j	P r t	M i n	O b s	I n f o	
67830000 hex	Target Position Positive Software Limit Exceeded	The specified position exceeds the positive software limit.	<ul style="list-style-type: none"> The parameter specified for the <i>Position</i> input variable to the instruction is beyond the positive software limit. The first position is beyond the positive software limit and an instruction that specifies motion in the opposite direction of the software limit was executed. 			○			O030
67840000 hex	Target Position Negative Software Limit Exceeded	The specified position exceeds the negative software limit.	<ul style="list-style-type: none"> The parameter specified for the <i>Position</i> input variable to the instruction is beyond the negative software limit. While the starting position is out of the negative software limit, an operation was specified in the opposite direction of the software limit. 			○			O030
67850000 hex	Command Position Overflow/Underflow	Positioning, an instruction in the underflow/overflow direction, or an instruction for which the direction is not specified was executed when there was an underflow/overflow in the command position.	<ul style="list-style-type: none"> One of the following was executed when there was a command position overflow/underflow. A positioning instruction A continuous control instruction in the underflow/overflow direction An instruction for which the direction is not specified (syncing) 			○			O030
67860000 hex	Positive Limit Input	An instruction was executed for a motion in the positive direction when the positive limit input was <i>ON</i> .	<ul style="list-style-type: none"> An instruction for a motion in the positive direction was executed when the positive limit input was <i>ON</i>, or an instruction for a motion with no direction specification was executed when the positive limit input was <i>ON</i>. 			○			O030
67870000 hex	Negative Limit Input	While the negative limit input is set to <i>ON</i> , an instruction that runs in the negative direction was executed.	<ul style="list-style-type: none"> While the negative limit input is set to <i>ON</i>, an instruction that runs in the negative direction was executed, or an instruction with no direction specified was executed. 			○			O030
67880000 hex	Positive Software Limit Exceeded	The position exceeded the positive software limit while the CNC motor was running.	<ul style="list-style-type: none"> The position exceeded the positive software limit. 			○			O030

Event code	Event name	Meaning	Assumed cause	Level					Reference
				M a j	P r t	M i n	O b s	I n f o	
67890000 hex	Negative Software Limit Exceeded	The position exceeded the negative software limit while the CNC motor was running.	<ul style="list-style-type: none"> The position exceeded the negative software limit. 			○			O030
678A0000 hex	In-position Check Time Exceeded	The in-position check was not completed within the monitoring time.	<ul style="list-style-type: none"> Time is required to complete positioning. 			○			O030
678B0000 hex	Following Error Limit Exceeded	The error between the command current position and actual current value exceeded the Following Error Over Value.	<ul style="list-style-type: none"> The positioning operation has poor following performance and the actual motion is slower than the command. 			○			O030
67910000 hex	Illegal Following Error	The difference between the command position and the actual current position exceeds the range of 30-bit data when converted to pulses.	<ul style="list-style-type: none"> The command current position was restricted so that the velocity of the CNC motor would not exceed the maximum velocity for the specified travel distance. The CNC motor's positioning operation has poor following performance and the actual motion is slower than the command. 			○			O030
67920000 hex	Absolute Encoder Current Position Calculation Failed	It was not possible to correctly restore the current position from the absolute encoder information that was saved when power was interrupted.	<ul style="list-style-type: none"> The position to restore when converted to pulses exceeded the range of signed 40-bit data. 			○			O030

Event code	Event name	Meaning	Assumed cause	Level					Reference
				M a j	P r t	M i n	O b s	I n f o	
67930000 hex	Home Undefined during Coordinated Motion	Home of the CNC motor became undefined while the status of CNC coordinate system is Executing (Executing), Hold (Holding), MovingOnHold (Manual Operation While Holding).	<ul style="list-style-type: none"> The command position or actual position overflowed or underflowed for a CNC motor while the status of CNC coordinate system is Executing (Executing), Hold (Holding), or MovingOnHold (Manual Operation While Holding), and the home definition was lost. A slave communications error occurred in the CNC motor and the home become undefined while the status of CNC coordinate system is Executing (Executing), Hold (Holding), or MovingOnHold (Manual Operation While Holding). A slave for a logical axis left the network or was disabled and home became undefined while the status of CNC coordinate system is Executing (Executing), Hold (Holding), or MovingOnHold (Manual Operation While Holding). 			○			O030
67940000 hex	Cycle Start Specified during Positive Software Limit Exceeded	The first position exceeds the positive software limit.	<ul style="list-style-type: none"> The command current position of the positioning cartesian axis or positioning rotational axis in the CNC coordinate system is out of range of the positive software limit. 			○			O030
67950000 hex	Cycle Start Specified during Negative Software Limit Exceeded	The first position exceeds the negative software limit.	<ul style="list-style-type: none"> The command current position of the positioning cartesian axis or positioning rotational axis in the CNC coordinate system is out of range of the negative software limit. 			○			O030
67960000 hex	Cycle Start Specified during Command Position Overflow (Underflow)	Positioning, an instruction in the underflow/overflow direction, or an instruction for which the direction is not specified was executed when there was an underflow/overflow in the command position.	<ul style="list-style-type: none"> One of the following was executed when there was a command position overflow/underflow. A positioning instruction A continuous control instruction in the underflow/overflow direction An instruction for which the direction is not specified (syncing) 			○			O030

Event code	Event name	Meaning	Assumed cause	Level					Reference
				M a j	P r t	M i n	O b s	I n f o	
67970000 hex	Cycle Start Specified during Positive Limit Input	A cycle start was executed when the positive limit input was ON.	<ul style="list-style-type: none"> A cycle start was executed when the positive limit input was ON. 			○			O030
67980000 hex	Cycle Start Specified during Negative Limit Input	A cycle start was executed when the negative limit input was ON.	<ul style="list-style-type: none"> A cycle start was executed when the negative limit input was ON. 			○			O030
67990000 hex	NC Program Execution Error	An error was detected while the NC program was running.	<p>An error was detected in the running NC program.</p> <ul style="list-style-type: none"> Refer to the Error Codes in Attached information for the error contents. 			○			O030
679B0000 hex	Position Deviation between Axes Limit Exceeded	The deviation of the feedback current position between the gantry master axis and the gantry slave axis exceeded the Position Deviation Between Axes Over Value.	<ul style="list-style-type: none"> The gantry slave axis is moving slower than the gantry master axis due to poor following performance of the slave axis. 			○			O030
679D0000 hex	CNC Motor Maximum Velocity Exceeded Error	The command velocity of the CNC motor exceeded the maximum velocity due to the feedrate override.	<ul style="list-style-type: none"> The value of feedrate override factor is too large. 			○			O030
77820000 hex	CNC Coordinate System Composition CNC Motor Error	An error occurred for a composition CNC motor in a CNC coordinate system.	<ul style="list-style-type: none"> An error occurred for a composition CNC motor in a CNC coordinate system while it was moving. 			○			O030
77830000 hex	CNC Common Error Occurrence	A CNC common error occurred.	<ul style="list-style-type: none"> Partial fault level CNC common error occurred. 			○			O030
77840000 hex	Servo Main Circuits OFF	An attempt was made to turn ON the Servo when the main circuit power supply to the Servo Drive was OFF.	<ul style="list-style-type: none"> An attempt was made to turn ON the Servo when the main circuit power supply to the Servo Drive was OFF. 			○			O030
77850000 hex	Servo Main Circuit Power OFF	The main circuit power of the Servo Drive turned OFF while the Servo was ON.	<ul style="list-style-type: none"> The main circuit power of the Servo Drive was interrupted while the Servo was ON. 			○			O030

Event code	Event name	Meaning	Assumed cause	Level					Reference
				M a j	P r t	M i n	O b s	I n f o	
77860000 hex	Slave Error Detected	An error was detected for the EtherCAT slave or NX Unit that is allocated to the CNC motor.	<ul style="list-style-type: none"> An error was detected for the EtherCAT slave or NX Unit that is allocated to the CNC motor. 			○			O030
77880000 hex	Slave Disconnection during Servo ON	An EtherCAT slave or NX Unit that is allocated to the CNC motor was disconnected, replaced, or disabled while the Servo was ON.	<ul style="list-style-type: none"> An EtherCAT slave or NX Unit that is allocated to the CNC motor was disconnected, replaced, or disabled while the Servo was ON. 			○			O030
77890000 hex	Homing Opposite Direction Limit Input Detected	The limit signal in the direction opposite to the homing direction was detected during a homing operation.	<ul style="list-style-type: none"> The Operation Selection at Negative Limit Input or Operation Selection at Positive Limit Input parameter is set to <i>No reverse turn</i>. The location of the homing input signal sensors, homing settings, and homing start position cause a limit input to be reached. The input signal sensor wiring is incorrect or the sensor is faulty. 			○			O030
778A0000 hex	Homing Direction Limit Input Detected	The limit signal in the homing direction was detected during a homing operation.	<ul style="list-style-type: none"> The Operation Selection at Negative Limit Input or Operation Selection at Positive Limit Input parameter is set to <i>No reverse turn</i>. The location of the homing input signal sensors, homing settings, and homing start position cause a limit input to be reached. The input signal sensor wiring is incorrect or the sensor is faulty. 			○			O030
778B0000 hex	Homing Limit Inputs Detected in Both Directions	The limit signals in both directions were detected during a homing operation.	<ul style="list-style-type: none"> The wiring of the limit signal is incorrect. The limit sensor is installed in the wrong location. The contact logic of the limit signal is not correct. The limit sensor failed. 			○			O030

Event code	Event name	Meaning	Assumed cause	Level					Reference
				M a j	P r t	M i n	O b s	I n f o	
778C0000 hex	Home Proximity/Homing Opposite Direction Limit Input Detected	The home proximity input and the limit signal in the direction opposite to the homing direction were detected at the same time during a homing operation.	<ul style="list-style-type: none"> The wiring of the home proximity signal or limit signal is incorrect. The home proximity sensor or limit sensor is installed in the wrong location. The contact logic of the home proximity signal or limit signal is not correct. The home proximity sensor or limit sensor failed. 			○			O030
778D0000 hex	Home Proximity/Homing Direction Limit Input Detected	The home proximity input and the limit signal in the homing direction were detected at the same time during a homing operation.	<ul style="list-style-type: none"> The wiring of the home proximity signal or limit signal is incorrect. The home proximity sensor or limit sensor is installed in the wrong location. The contact logic of the home proximity signal or limit signal is not correct. The home proximity sensor or limit sensor failed. 			○			O030
778E0000 hex	Home Input/Homing Opposite Direction Limit Input Detected	The home input and the limit signal in the direction opposite to the homing direction were detected at the same time during a homing operation.	<ul style="list-style-type: none"> The wiring of the home input signal or limit signal is incorrect. The home input sensor or limit sensor is installed in the wrong location. The contact logic of the home input signal or limit signal is not correct. The home input signal output device or limit sensor failed. 			○			O030
778F0000 hex	Home Input/Homing Direction Limit Input Detected	The home input and the limit signal in the homing direction were detected at the same time during a homing operation.	<ul style="list-style-type: none"> The wiring of the home input signal or limit signal is incorrect. The home input sensor or limit sensor is installed in the wrong location. The contact logic of the home input signal or limit signal is not correct. The home input signal output device or limit sensor failed. 			○			O030

Event code	Event name	Meaning	Assumed cause	Level					Reference
				M a j	P r t	M i n	O b s	I n f o	
77900000 hex	Invalid Home Input Mask Distance	The setting of the home input mask distance is not suitable for the CNC_Home or CNC_HomeWith-Parameter instruction.	<ul style="list-style-type: none"> The set value of the home input mask distance when the operating mode of the MC_Home instruction is set to <i>Proximity Reverse Turn/Home Input Mask Distance</i> is insufficient to decelerate from the homing velocity to the homing approach velocity. 				○		O030
77910000 hex	No Home Input	There was no home signal input during the homing operation. Or, a limit signal was detected before there was a home input.	<ul style="list-style-type: none"> There was no home signal input during the homing operation. A limit signal was detected before there was a home input. 				○		O030
77920000 hex	No Home Proximity Input	There was no home proximity signal input during the homing operation.	<ul style="list-style-type: none"> There was no home proximity signal input during the homing operation when a <i>home proximity input signal</i> was specified. 				○		O030
87800000 hex	EtherCAT Slave Communications Error	A communications error occurred for the EtherCAT slave or NX Unit that is allocated to a CNC motor.	<ul style="list-style-type: none"> A communications error occurred for the EtherCAT slave or NX Unit that is allocated to the CNC motor. 				○		O030
561D0000 hex	SD Memory Card Access Failure	SD Memory Card access failed when an instruction was executed.	<ul style="list-style-type: none"> An SD Memory Card is not inserted. The SD Memory Card is damaged. The SD Memory Card slot is broken. 					○	O030
561E0000 hex	File Does Not Exist	The file specified for an instruction does not exist.	<ul style="list-style-type: none"> The specified file does not exist. 					○	O030
561F0000 hex	Illegal Load NC Program Number Specification	Loading has failed because an attempt was made to load the NC program with an invalid program number specified.	<ul style="list-style-type: none"> An attempt was made to load the NC program with an invalid program number specified. 					○	O030
56200000 hex	Too Many Files Open	The maximum number of open files was exceeded when opening a file for an instruction.	<ul style="list-style-type: none"> The maximum number of open files was exceeded when opening a file for an instruction. 					○	O030
56210000 hex	File or Directory Name Is Too Long	The file name or directory name that was specified for an instruction is too long.	<ul style="list-style-type: none"> The file name or directory name that was specified for the instruction to create is too long. 					○	O030

Event code	Event name	Meaning	Assumed cause	Level					Reference
				M a j	P r t	M i n	O b s	I n f o	
56220000 hex	SD Memory Card Access Failed	SD Memory Card access failed.	<ul style="list-style-type: none"> The SD Memory Card is damaged. The SD Memory Card slot is broken. 				○		O030
56230000 hex	Load NC Program Capacity Exceeded	Loading has failed because an attempt was made to load the NC program that has a capacity above the maximum.	<ul style="list-style-type: none"> An attempt was made to load the NC program that has a capacity above the maximum. 				○		O030
56240000 hex	Number of NC Program Exceeded	Loading failed because an attempt was made to load NC programs over the maximum number of NC programs.	<ul style="list-style-type: none"> A new NC program was loaded while the number of loaded NC programs reaches the maximum. 				○		O030
56280000 hex	Illegal Load NC Program	An error was detected in the loaded NC program.	<ul style="list-style-type: none"> A syntax error was detected in the NC program you attempted to load. 				○		O030
678C0000 hex	Following Error Warning	The following error exceeded the Following Error Warning Value.	<ul style="list-style-type: none"> The positioning operation has poor following performance and the actual motion is slower than the command. 				○		O030
678D0000 hex	Command Position Overflow	The number of pulses for the command position overflowed.	<ul style="list-style-type: none"> When the command position was converted to the pulse unit for the positioning cartesian axis or positioning rotational axis, the specified value exceeded the upper limit of the signed 40-bit data (signed 54-bit data for the spindle axis). 				○		O030
678E0000 hex	Command Position Underflow	The number of pulses for the command position exceeded the valid range. (It underflowed.)	<ul style="list-style-type: none"> When the command position was converted to the pulse unit for the positioning cartesian axis or positioning rotational axis, the specified value exceeded the lower limit of the signed 40-bit data (signed 54-bit data for the spindle axis). 				○		O030
678F0000 hex	Actual Position Overflow	The number of pulses for the actual position overflowed.	<ul style="list-style-type: none"> When the command position was converted to the pulse unit for the positioning cartesian axis or positioning rotational axis, the specified value exceeded the upper limit of the signed 40-bit data (signed 54-bit data for the spindle axis). 				○		O030

Event code	Event name	Meaning	Assumed cause	Level					Reference
				M a j	P r t	M i n	O b s	I n f o	
67900000 hex	Actual Position Underflow	The number of pulses for the actual position underflowed.	<ul style="list-style-type: none"> When the command position was converted to the pulse unit for the positioning cartesian axis or positioning rotational axis, the specified value exceeded the lower limit of the signed 40-bit data (signed 54-bit data for the spindle axis). 				○		O030
679A0000 hex	Position Deviation between Axes Limit Warning	The deviation of the feedback current position between the gantry master axis and the gantry slave axis exceeded the Position Deviation Between Axes Warning Value.	<ul style="list-style-type: none"> The gantry slave axis is moving slower than the gantry master axis due to poor following performance of the slave axis. 				○		O030
679C0000 hex	CNC Motor Maximum Velocity Exceeded Warning	The command velocity of the CNC motor exceeded the maximum velocity due to the feedrate override.	<ul style="list-style-type: none"> The value of feedrate override factor is too large. 				○		O030
77810000 hex	CNC Planner Service Period Exceeded	CNC planner service processing was not finished within two periods.	<ul style="list-style-type: none"> The processing load of the NC program in a period of the CNC planner service is too heavy. 				○		O030
77870000 hex	Slave Observation Detected	A warning was detected for an EtherCAT slave or NX Unit.	<ul style="list-style-type: none"> A warning was detected for the EtherCAT slave or NX Unit that is allocated to a CNC motor. 				○		O030
97810000 hex	Software Limit Path Limited	The path exceeded the software limit was specified during Executing (Executing). Therefore, the path was limited within the software limit range.	<ul style="list-style-type: none"> The path exceeded the software limit was specified during Executing (Executing). 				○		O030
97830000 hex	Velocity Control Command Value Saturated	The velocity control command value for the servo drive is saturated.	<ul style="list-style-type: none"> The output value by feedback loop calculation exceeded Maximum Velocity defined in the CNC motor parameter, or the actual operation is slower than the commanded one because of the poor following performance of the positioning operation. The spindle rotation velocity (S) or spindle velocity override value was commanded over the Maximum Velocity defined in the CNC motor parameter. 				○		O030

Event code	Event name	Meaning	Assumed cause	Level					Reference
				M a j	P r t	M i n	O b s	I n f o	
97800000 hex	Slave Error Code Report	The error code was reported by the slave when a <i>Slave Error Detected</i> error occurred.	<ul style="list-style-type: none"> The error code was reported by the slave when a <i>Slave Error Detected</i> error (77860000 hex) occurred. 					○	O030
97820000 hex	CNC Function System Information	This event provides internal information from the CNC Function Module.	<ul style="list-style-type: none"> This event provides internal information from the CNC Function Module. It is recorded to provide additional information for another event. 					○	O030

A

CNC Instructions

This section shows lists of errors (events) that may occur in CNC instructions. The lower four digits of the event code represents the error code (ErrorID) for the instruction. For details of error codes, refer to the description of the corresponding event code. For example, when the error code of the target instruction is 16#3781, refer to the explanation of event code, 54013781 hex.

The manual names are given below for the catalog numbers given in the Reference column of the event table.

Cat. No.	Manual name
O030	NJ/NY-series NC Integrated Controller User's Manual

Event code	Event name	Meaning	Assumed cause	Level					Reference
				M a j	P r t	M i n	O b s	I n f o	
54013781 hex	Process Data Object Setting Missing	The PDO mapping is not correct.	<ul style="list-style-type: none"> The PDOs that are required for the CNC instruction are not mapped. The relevant instruction was executed for a device that does not have an object that supports the instruction. 				○		O030
54015600 hex	Illegal CNC Coordinate System Specification	The CNC coordinate system specified for the <i>Coord</i> in-out variable to a CNC instruction does not exist.	<ul style="list-style-type: none"> CNC coordinate system does not exist for the variable specified for the <i>Coord</i> in-out variable to the instruction. 				○		O030
54015601 hex	Deceleration Setting Out of Range	The parameter specified for the <i>Deceleration</i> input variable to a CNC instruction is out of range.	<ul style="list-style-type: none"> Instruction input parameter exceeded the valid range of the input variable. 				○		O030
54015602 hex	Jerk Setting Out of Range	The parameter specified for the Jerk input variable to a CNC instruction is out of range.	<ul style="list-style-type: none"> Instruction input parameter exceeded the valid range of the input variable. 				○		O030
54015603 hex	CNC Instruction Re-execution Disabled	A CNC instruction that cannot be re-executed was re-executed.	<ul style="list-style-type: none"> A CNC instruction that cannot be re-executed was re-executed. 				○		O030

Event code	Event name	Meaning	Assumed cause	Level					Reference
				M a j	P r t	M i n	O b s	I n f o	
54015604 hex	CNC Multi-execution Disabled	Multiple functions that cannot be executed simultaneously were executed for the same target (CNC coordinate system).	<ul style="list-style-type: none"> Multiple functions that cannot be executed simultaneously were executed for the same target (CNC coordinate system). The CNC_LoadProgramFile instruction was executed when any of CNC coordinate system was Executing (Executing) or Hold (Holding). 				○		O030
54015605 hex	Unassigned Logical CNC Motor Number Specified	The CNC motor of the parameter specified for the LogicalMotorNo input variable to the CNC instruction is not assigned.	<ul style="list-style-type: none"> The logical CNC motor number for which the CNC motor is not assigned to the LogicalMotorNo input variable to the CNC instruction was specified, and the instruction was executed. 				○		O030
54015606 hex	Logical CNC Motor Number Out of Range	The parameter specified for the LogicalMotorNo input variable to a CNC instruction is out of range.	<ul style="list-style-type: none"> Instruction input parameter exceeded the valid range of the input variable. 				○		O030
54015607 hex	Target Position Setting Out of Range	The parameter specified for the <i>Position</i> input variable to a CNC instruction is out of range.	<ul style="list-style-type: none"> Instruction input parameter exceeded the valid range of the input variable. Or, there was an overflow/underflow in the target position. 				○		O030
54015608 hex	Impossible CNC Motor Operation Specified when the Servo is OFF	An operation instruction was executed for the CNC motor for which the Servo is OFF.	<ul style="list-style-type: none"> An operation instruction was executed for the CNC motor for which the Servo is OFF. Home was preset with the CNC_Home or CNC_Home-WithParameter instruction for an axis for which EtherCAT process data communications are not established. 				○		O030
54015609 hex	Target Velocity Setting Out of Range	The parameter specified for the <i>Velocity</i> input variable instruction is out of range.	<ul style="list-style-type: none"> Instruction input parameter exceeded the valid range of the input variable. 				○		O030
5401560A hex	Acceleration/Deceleration Setting Out of Range	The parameter specified for the <i>Acceleration</i> input variable to a CNC instruction is out of range.	<ul style="list-style-type: none"> Instruction input parameter exceeded the valid range of the input variable. 				○		O030

Event code	Event name	Meaning	Assumed cause	Level					Reference
				M a j	P r t	M i n	O b s	I n f o	
5401560B hex	Travel Mode Selection Out of Range	The parameter specified for the <i>MoveMode</i> input variable to a CNC instruction is out of range.	<ul style="list-style-type: none"> Instruction input parameter exceeded the valid range of the input variable. 				○		O030
5401560D hex	Parameter Selection Out of Range	The parameter specified for the <i>ParameterNumber</i> input variable to a CNC instruction is out of range.	<ul style="list-style-type: none"> Instruction input parameter exceeded the valid range of the input variable. 				○		O030
5401560E hex	CNC Parameter Setting Read/Write Setting Value Out of Range	The parameter specified for the <i>SettingValue</i> in-out variable to a CNC instruction is out of range.	<ul style="list-style-type: none"> Instruction input parameter exceeded the valid range of the in-out variable. 				○		O030
5401560F hex	CNC Parameter Setting Read/Write Target Out of Range	The parameter specified for the <i>Target</i> in-out variable to a CNC instruction is out of range.	<ul style="list-style-type: none"> Instruction input parameter exceeded the valid range of the in-out variable. 				○		O030
54015611 hex	Homing Parameter Setting Out of Range	The parameter specified for the <i>HomingParameter</i> in-out variable of the CNC instruction is out of range.	<ul style="list-style-type: none"> Instruction input parameter exceeded the valid range of the in-out variable. 				○		O030
54015612 hex	M Code Number Out of Range	The parameter specified for the <i>MCodeNo</i> input variable to a CNC instruction is out of range.	<ul style="list-style-type: none"> Instruction input parameter exceeded the valid range of the input variable. 				○		O030
54015613 hex	CNC Instruction Re-execution Disabled (CNC Coordinate System Specification)	An attempt was made to change the parameter for the <i>Coord</i> in-out variable when re-executing a CNC instruction. (This in-out variable cannot be changed when re-executing an instruction.)	<ul style="list-style-type: none"> A parameter for an in-out variable that cannot be changed for re-execution was changed. 				○		O030

Event code	Event name	Meaning	Assumed cause	Level					Reference
				M a j	P r t	M i n	O b s	I n f o	
54015614 hex	CNC Instruction Re-execution Disabled (Logical CNC Motor Number)	An attempt was made to change the parameter for the <i>Logical/MotorNo</i> input variable when re-executing a CNC instruction. (This input variable cannot be changed when re-executing an instruction.)	<ul style="list-style-type: none"> A parameter for an input variable that cannot be changed for re-execution was changed. 				○		O030
5401561D hex	SD Memory Card Access Failure	SD Memory Card access failed when an instruction was executed.	<ul style="list-style-type: none"> An SD Memory Card is not inserted. The SD Memory Card is damaged. The SD Memory Card slot is broken. 				○		O030
5401561E hex	File Does Not Exist	The file specified for an instruction does not exist.	<ul style="list-style-type: none"> The specified file does not exist. 				○		O030
5401561F hex	Illegal Load NC Program Number Specification	Loading has failed because an attempt was made to load the NC program with an invalid program number specified.	<ul style="list-style-type: none"> An attempt was made to load the NC program with an invalid program number specified. 				○		O030
54015620 hex	Too Many Files Open	The maximum number of open files was exceeded when opening a file for an instruction.	<ul style="list-style-type: none"> The maximum number of open files was exceeded when opening a file for an instruction. 				○		O030
54015621 hex	File or Directory Name Is Too Long	The file name or directory name that was specified for an instruction is too long.	<ul style="list-style-type: none"> The file name or directory name that was specified for the instruction to create is too long. 				○		O030
54015622 hex	SD Memory Card Access Failed	SD Memory Card access failed.	<ul style="list-style-type: none"> The SD Memory Card is damaged. The SD Memory Card slot is broken. 				○		O030
54015623 hex	Load NC Program Capacity Exceeded	Loading has failed because an attempt was made to load the NC program that has a capacity above the maximum.	<ul style="list-style-type: none"> An attempt was made to load the NC program that has a capacity above the maximum. 				○		O030
54015624 hex	Number of NC Program Exceeded	Loading failed because an attempt was made to load NC programs over the maximum number of NC programs.	<ul style="list-style-type: none"> A new NC program was loaded while the number of loaded NC programs reaches the maximum. 				○		O030

Event code	Event name	Meaning	Assumed cause	Level					Reference
				M a j	P r t	M i n	O b s	I n f o	
54015625 hex	Illegal CNC Motor Specification	The CNC motor specified for the <i>Target</i> in-out variable to a CNC instruction does not exist.	<ul style="list-style-type: none"> A CNC motor does not exist for the variable specified for the <i>Target</i> input variable to the instruction. 				○		O030
54015626 hex	Illegal CNC Motor Compensation Table Specification	The CNC motor compensation table specified for the <i>Target</i> input variable to a CNC instruction does not exist.	<ul style="list-style-type: none"> A CNC motor compensation table does not exist for the variable specified for the <i>Target</i> input variable to the instruction. 				○		O030
54015628 hex	Illegal Load NC Program	An error was detected in the loaded NC program.	<ul style="list-style-type: none"> A syntax error was detected in the NC program you attempted to load. 				○		O030
5401562A hex	Skew Control Mode Out of Range	The parameter specified for the <i>SkewMode</i> input variable to a CNC instruction is out of range.	<ul style="list-style-type: none"> Instruction input parameter exceeded the valid range of the input variable. 				○		O030
5401562B hex	Offset Value Setting Out of Range	The parameter specified for the <i>OffsetValue</i> input variable to a CNC instruction is out of range.	<ul style="list-style-type: none"> Instruction input parameter exceeded the valid range of the input variable. 				○		O030
54016783 hex	Target Position Positive Software Limit Exceeded	The specified position exceeds the positive software limit.	<ul style="list-style-type: none"> The parameter specified for the <i>Position</i> input variable to the instruction is beyond the positive software limit. The first position is beyond the positive software limit and an instruction that specifies motion in the opposite direction of the software limit was executed. 				○		O030
54016784 hex	Target Position Negative Software Limit Exceeded	The specified position exceeds the negative software limit.	<ul style="list-style-type: none"> The parameter specified for the <i>Position</i> input variable to the instruction is beyond the negative software limit. While the first position is out of the negative software limit, an operation was specified in the opposite direction of the software limit. 				○		O030

Event code	Event name	Meaning	Assumed cause	Level					Reference
				M a j	P r t	M i n	O b s	I n f o	
54016785 hex	Command Position Overflow/ Underflow	Positioning, an instruction in the underflow/overflow direction, or an instruction for which the direction is not specified was executed when there was an underflow/ overflow in the command position.	<ul style="list-style-type: none"> One of the following was executed when there was a command position overflow/underflow. A positioning instruction A continuous control instruction in the underflow/overflow direction An instruction for which the direction is not specified (syncing) 				○		O030
54016786 hex	Positive Limit Input	An instruction was executed for a motion in the positive direction when the positive limit input was ON.	<ul style="list-style-type: none"> An instruction for a motion in the positive direction was executed when the positive limit input was ON, or an instruction for a motion with no direction specification was executed when the positive limit input was ON. 				○		O030
54016787 hex	Negative Limit Input	While the negative limit input is set to ON, an instruction that runs in the negative direction was executed.	<ul style="list-style-type: none"> While the negative limit input is set to ON, an instruction that runs in the negative direction was executed, or an instruction with no direction specified was executed. 				○		O030
54017784 hex	Servo Main Circuits OFF	An attempt was made to turn ON the Servo when the main circuit power supply to the Servo Drive was OFF.	<ul style="list-style-type: none"> An attempt was made to turn ON the Servo when the main circuit power supply to the Servo Drive was OFF. 				○		O030

A-2 Errors (Events) That Can Occur in Connected Devices

The section provides tables of the errors (events) that can occur in the devices connected to NJ/NX-series CPU Unit. Refer to *3-1 Interpreting Tables* on page 3-3 for interpreting error tables. Refer to the manual for the specific product for details on errors.

A-2-1 Errors in Slave Terminals

The section provides tables of the errors (events) that can occur in the following Units in OMRON Slave Terminals.

- NX-series EtherCAT Coupler Units
- NX-series Digital I/O Units
- NX-series Analog I/O Units
- NX-series System Units
- NX-series Position Interface Units
- NX-series Communications Interface Unit
- NX-series Safety CPU Units
- NX-series Safety I/O Units
- NX-series Load Cell Input Units
- NX-series IO-Link Master Units
- NX-series Temperature Control Units
- NX-series EtherNet/IP Unit
- NX-series High-speed Counter Units

NX-series EtherCAT Coupler Units

The section provides a table of the errors (events) that can occur in the following Unit.
NX-ECC□□□

The manual names are given below for the catalog numbers given in the Reference column of the event table.

Cat. No.	Manual name
W519	NX-series EtherCAT Coupler Unit User's Manual

Event code	Event name	Meaning	Assumed cause	Level					Reference
				M a j	P r t	M i n	O b s	I n f o	
00210000 hex	Bus Controller Error	An internal bus error occurred.	<ul style="list-style-type: none"> • A Unit failed or an I/O communications error occurred between the Communications Coupler Unit and the NX Unit. 			○			W519



Event code	Event name	Meaning	Assumed cause	Level					Reference
				M a j	P r t	M i n	O b s	I n f o	
00220000 hex	Non-volatile Memory Hardware Error	An error occurred in non-volatile memory.	<ul style="list-style-type: none"> Non-volatile memory failure 			○			W519
05010000 hex	ESC Error	An error occurred in the EtherCAT slave communications controller.	<ul style="list-style-type: none"> An error occurred in the EtherCAT slave communications controller. 			○			W519
05020000 hex	ESC Initialization Error	Initialization of the EtherCAT slave communications controller failed.	<ul style="list-style-type: none"> An initialization error occurred in the EtherCAT slave communications controller. 			○			W519
05030000 hex	Slave Unit Verification Error	An error occurred in Slave Unit verification.	<ul style="list-style-type: none"> An error occurred in Slave Unit information. 			○			W519
10420000 hex	Non-volatile Memory Control Parameter Error	An error occurred in the control parameters.	<ul style="list-style-type: none"> The power supply to the Communications Coupler Unit was turned OFF or Support Software communications were disconnected while writing the Unit operation settings was in progress. 			○			W519
10430000 hex	Memory Corruption Detected	Memory corruption was detected.	<ul style="list-style-type: none"> Memory corruption was detected. 			○			W519
24A00000 hex	Unit Configuration Error, Too Many Units	The number of connected NX Units exceeds the maximum value for the Communications Coupler Unit.	<ul style="list-style-type: none"> More than the maximum number of NX Units is connected to the Communications Coupler Unit. 			○			W519
24A10000 hex	Unit Configuration Error, Unsupported Configuration	An unsupported NX Unit is mounted. Or, the total byte size of all I/O data for the connected NX Units exceeds the predetermined maximum value for the Communications Coupler Unit.	<ul style="list-style-type: none"> An unsupported NX Unit was detected. The total byte size of all I/O data for the connected NX Units exceeds the predetermined maximum value for the Communications Coupler Unit. 			○			W519
35000000 hex	Unit Configuration Information Error	An error occurred in the Unit configuration information in the Communications Coupler Unit.	<ul style="list-style-type: none"> The power supply to the Communications Coupler Unit was turned OFF or Support Software communications were disconnected while downloading the Unit configuration information. 			○			W519

Event code	Event name	Meaning	Assumed cause	Level					Reference
				M a j	P r t	M i n	O b s	I n f o	
35010000 hex	Unit Configuration Verification Error	There is an inconsistency between the Unit configuration information in the Communications Coupler Unit and the Units that are actually connected. Or, the Unit configuration was changed during operation while the Unit configuration information was not set in the Communications Coupler Unit.	<ul style="list-style-type: none"> An NX Unit that is registered in the Unit configuration information is not connected. A connected NX Unit does not agree with the NX Unit that is registered in the Unit configuration information. An NX Unit that is not registered in the Unit configuration information is connected. A mounted Unit is disabled in the NX Unit Mounting Setting for the Unit configuration information. An NX Unit became disconnected during operation. An NX Unit was connected during operation. The serial number of a Unit that is registered in the Unit configuration information does not agree with the serial number of the Unit that is connected. (The Serial Number Check Method is set to Setting = Actual device.) The version of a Unit that is registered in the Unit configuration information is newer than the version of the Unit that is connected. The power supply to the Additional NX Unit Power Supply Unit is not turned ON. 			○			W519
35020000 hex	NX Unit Minor Fault	A minor fault was detected in an NX Unit.	<ul style="list-style-type: none"> A minor fault level error occurred in a Unit where an error was detected. 			○			W519
35040000 hex	Mailbox Setting Error	An incorrect mailbox setting was detected for the Sync Manager. (AL-Status Code: 0016 hex)	<ul style="list-style-type: none"> An incorrect mailbox setting was detected for the Sync Manager. 			○			W519
35050000 hex	RxPDO Setting Error	An error was detected in the RxPDO settings. (AL-Status Code: 001D hex)	<ul style="list-style-type: none"> An error was detected in the RxPDO settings. 			○			W519
35060000 hex	TxPDO Setting Error	An error was detected in the TxPDO settings. (AL-Status Code: 001E hex)	<ul style="list-style-type: none"> An error was detected in the TxPDO settings. 			○			W519

Event code	Event name	Meaning	Assumed cause	Level					Reference
				M a j	P r t	M i n	O b s	I n f o	
35070000 hex	PDO WDT Setting Error	An incorrect PDO WDT setting was detected. (AL-Status Code: 001F hex)	<ul style="list-style-type: none"> An incorrect PDO WDT setting was detected. 			○			W519
35080000 hex	SM Event Mode Setting Error	An SM Event Mode that is not supported was set. (AL-Status Code: 0028 hex)	<ul style="list-style-type: none"> An SM Event Mode that is not supported was set. 			○			W519
35090000 hex	TxPDO Mapping Error	An incorrect TxPDO was set. (AL-Status Code: 0024 hex)	<ul style="list-style-type: none"> An incorrect TxPDO was set, e.g., the index, subindex, or size was outside of the allowable range. 			○			W519
350A0000 hex	RxPDO Mapping Error	An incorrect RxPDO was set. (AL-Status Code: 0025 hex)	<ul style="list-style-type: none"> An incorrect RxPDO was set, e.g., the index, subindex, or size was outside of the allowable range. 			○			W519
350B0000 hex	Illegal State Transition Request Received	An incorrect state transition request was received. (AL-Status Code: 0011 hex)	<ul style="list-style-type: none"> An incorrect state transition request was received. 			○			W519
350C0000 hex	Error State Transition Received	An incorrect state transition request was received. (AL-Status Code: 0012 hex)	<ul style="list-style-type: none"> An unclear state transition request was received. 			○			W519
350D0000 hex	Synchronization Cycle Setting Error	When DC Mode was confirmed, the cycle time was set to a value that made operation impossible. (AL-Status Code: 0035 hex)	<ul style="list-style-type: none"> When DC Mode was confirmed, the cycle time was set to a value that made operation impossible. 			○			W519
40200000 hex	NX Unit Processing Error	A fatal error occurred in an NX Unit.	<ul style="list-style-type: none"> An error occurred in the software. 			○			W519
84C00000 hex	NX Unit Communications Timeout	An error occurred in I/O data communications with the NX Units.	<ul style="list-style-type: none"> An NX Unit is not mounted properly. An NX Unit has failed. 			○			W519
84C10000 hex	NX Unit Initialization Error	Initializing an NX Unit failed.	<ul style="list-style-type: none"> An error occurred in processing the Communications Coupler Unit. An initialization error occurred in an NX Unit. The Enabled Channel Settings for all channels of the Analog Input Unit are set to Disable. The Enabled Channel Settings for all channels of the Analog Output Unit are set to Disable. 			○			W519

Event code	Event name	Meaning	Assumed cause	Level					Reference
				M a j	P r t	M i n	O b s	I n f o	
85000000 hex	Process Data WDT Error	Process data communications were stopped for more than the specified period of time.	<ul style="list-style-type: none"> The EtherCAT communications cable is disconnected or broken. There is an error in the host controller. 			○			W519
85010000 hex	Synchronization Interruption Error	A synchronization interruption error occurred.	<ul style="list-style-type: none"> The EtherCAT communications cable is disconnected or broken. There is a synchronization setting error in the EtherCAT Coupler Unit. There is a hardware error in the EtherCAT Coupler Unit. 			○			W519
85020000 hex	Synchronization Error	A synchronization error occurred.	<ul style="list-style-type: none"> The EtherCAT communications cable is disconnected or broken. There is a synchronization setting error in the EtherCAT master or EtherCAT Coupler Unit. There is a hardware error in the EtherCAT Coupler Unit. 			○			W519
85030000 hex	Communications Synchronization Error	The number of consecutive communications errors in receiving the synchronization data exceeded the value that is set for the Consecutive Communications Error Detection Count parameter in the Communications Error Settings.	<ul style="list-style-type: none"> Power to the host controller was interrupted during process data communications. The EtherCAT communications cable is disconnected or broken. Noise is entering on an EtherCAT communications cable. 			○			W519
84C50000 hex	NX Unit Startup Error	Starting an NX Unit failed.	<ul style="list-style-type: none"> A startup error occurred in an NX Unit. 			○			W519
35030000 hex	NX Unit Observation	An observation was detected in an NX Unit.	<ul style="list-style-type: none"> An observation level error occurred in a Unit where an error was detected. This event is recorded in the event log in the Communications Coupler Unit. 				○		W519
350E0000 hex	NX Bus Cycle Delay Detected	Exceeding the NX bus cycle was detected.	<ul style="list-style-type: none"> The NX bus cycle was exceeded. 				○		W519

Event code	Event name	Meaning	Assumed cause	Level					Reference
				M a j	P r t	M i n	O b s	I n f o	
80220000 hex	NX Message Communications Error	An error was detected in message communications and the message frame was discarded.	For the NX bus of CPU Units <ul style="list-style-type: none"> The message communications load is high. For Communications Coupler Units <ul style="list-style-type: none"> The message communications load is high. The communications cable is disconnected or broken. This cause does not apply if attached information 2 is 0 (NX bus). Message communications were cutoff in communications. 				○		W519
90400000 hex	Event Log Cleared	The event log was cleared.	<ul style="list-style-type: none"> The event log was cleared by the user. 				○		W519
90420000 hex	Restart Executed	A restart was executed.	<ul style="list-style-type: none"> A restart command was received. 				○		W519
90430000 hex	Memory All Cleared	The Unit settings were cleared.	<ul style="list-style-type: none"> The non-volatile memory in the EtherCAT Coupler Unit was cleared. 				○		W519
94600000 hex (Ver. 1.07 or later)	I/O Check Execution Started	I/O checking was started.	<ul style="list-style-type: none"> I/O checking was started. 				○		W519

A

NX-series Digital I/O Units

The section provides a table of the errors (events) that can occur in the following Units.

NX-ID□□□□

NX-OC□□□□

NX-OD□□□□

The manual names are given below for the catalog numbers given in the Reference column of the event table.

Cat. No.	Manual name
W521	NX-series Digital I/O Unit User's Manual

Event code	Event name	Meaning	Assumed cause	Level					Reference
				M a j	P r t	M i n	O b s	I n f o	
00200000 hex	Non-volatile Memory Hardware Error	An error occurred in non-volatile memory.	<ul style="list-style-type: none"> Non-volatile memory failure 			○			W521
10410000 hex	Control Parameter Error in Master	An error occurred in the control parameters that are saved in the master.	<p>For the NX bus of CPU Units</p> <ul style="list-style-type: none"> The power supply to the CPU Unit was turned OFF while writing the Unit operation settings was in progress. Or there is an error in the area of the non-volatile memory in the CPU Unit in which the Unit operation settings for the relevant NX Unit are saved. <p>For Communications Coupler Units</p> <ul style="list-style-type: none"> The power supply to the Communications Coupler Unit was turned OFF while writing the Unit operation settings was in progress. Or there is an error in the area of the non-volatile memory in the Communications Coupler Unit in which the Unit operation settings for the relevant NX Unit are saved. 			○			W521



Event code	Event name	Meaning	Assumed cause	Level					Reference
				M a j	P r t	M i n	O b s	I n f o	
80200000 hex	NX Unit I/O Communications Error	An I/O communications error occurred in an NX Unit.	<p>For the NX bus of CPU Units</p> <ul style="list-style-type: none"> An error that prevents normal NX bus communications occurred in a CPU Unit. An NX Unit is not mounted properly. The power cable for the Unit power supply is disconnected, or the wiring from the Unit power supply to the NX Units is incorrect. The power cable for the Unit power supply is broken. The voltage of the Unit power supply is outside the specified range, or the capacity of the Unit power supply is insufficient. There is a hardware error in an NX Unit. <p>For Communications Coupler Units</p> <ul style="list-style-type: none"> An error that prevents normal NX bus communications occurred in a Communications Coupler Unit. The NX Unit is not mounted properly. The power cable for the Unit power supply is disconnected. Or, the wiring from the Unit power supply to the NX Units is incorrect. The power cable for the Unit power supply is broken. The voltage of the Unit power supply is outside the specified range. Or, the capacity of the Unit power supply is insufficient. There is a hardware error in the NX Unit. 						W521

Event code	Event name	Meaning	Assumed cause	Level					Reference
				M a j	P r t	M i n	O b s	I n f o	
80210000 hex	NX Unit Output Synchronization Error	An output synchronization error occurred in the NX Unit.	<p>For the NX bus of CPU Units</p> <ul style="list-style-type: none"> I/O refreshing on the NX bus is not performed normally due to an error in the CPU Unit. <p>For Communications Coupler Units</p> <ul style="list-style-type: none"> The communications cable connected to the Communications Coupler Unit is broken or the connection is faulty. The communications cable is affected by noise. 			○			W521
80240000 hex	NX Unit Clock Not Synchronized Error	A time information error occurred in an NX Unit.	<p>For the NX bus of CPU Units</p> <ul style="list-style-type: none"> There is a hardware error in an NX Unit. There is a hardware error in a CPU Unit. <p>For Communications Coupler Units</p> <ul style="list-style-type: none"> There is a hardware error in an NX Unit. There is a hardware error in an EtherCAT Coupler Unit. 			○			W521
70010000 hex (Ver. 1.06)	Previous Time Specified	A previous time was specified for output refreshing with a specified time stamp.	<p>For the NX bus of CPU Units</p> <ul style="list-style-type: none"> A past time is specified due to an error in the user program. A Task Period Exceeded error occurred in a CPU Unit. <p>For Communications Coupler Units</p> <ul style="list-style-type: none"> A past time is specified due to an error in the user program. A Task Period Exceeded error occurred in a CPU Unit. The arrival of I/O data at an NX Unit was delayed due to a Communications Synchronization Error or other communications error. 				○		W521
90400000 hex	Event Log Cleared	The event log was cleared.	<ul style="list-style-type: none"> The event log was cleared by the user. 					○	W521

NX-series Analog I/O Units

The section provides a table of the errors (events) that can occur in the following Units.

NX-AD□□□□

NX-DA□□□□

NX-TS□□□□

NX-HB□□□□

The manual names are given below for the catalog numbers given in the Reference column of the event table.

Cat. No.	Manual name
W522	NX-series Analog I/O Units User's Manual for Analog Input Units and Analog Output Units
W566*1	NX-series Analog I/O Units User's Manual for Temperature Input Units and Heater Burnout Detection Units

*1. Temperature Input Units are introduced in Cat. No. W522 before Cat. No. W566 is released.

● Analog Input Units and Analog Output Units (NX-AD□□□□, NX-DA□□□□)

Event code	Event name	Meaning	Assumed cause	Level					Reference
				M a j	P r t	M i n	O b s	I n f o	
00200000 hex	Non-volatile Memory Hardware Error	An error occurred in non-volatile memory.	<ul style="list-style-type: none"> Non-volatile memory failure 				○		W522
10400000 hex	Analog Unit Calibration Parameter Error	An error occurred for the calibration data in the Analog Unit.	<ul style="list-style-type: none"> The power supply to the Analog Unit was turned OFF or Support Software communications were disconnected while writing the calibration values to the Analog Unit. 				○		W522
10410000 hex	Control Parameter Error in Master	An error occurred in the control parameters that are saved in the master.	For the NX bus of CPU Units <ul style="list-style-type: none"> The power supply to the CPU Unit was turned OFF while writing the Unit operation settings was in progress. Or there is an error in the area of the non-volatile memory in the CPU Unit in which the Unit operation settings for the relevant NX Unit are saved. 				○		W522
14C00000 hex	Unit Calibration Value Parity Error	An error occurred in the user calibration data in the NX Unit.	<ul style="list-style-type: none"> An error was detected in the calibration data. 				○		W522
65030000 hex	Unit I/O Disconnection Detected for Channel 1	A disconnected input was detected for channel 1.	<ul style="list-style-type: none"> Input wiring is broken. Input wiring is disconnected. 				○	○	W522

A

Event code	Event name	Meaning	Assumed cause	Level					Reference
				M a j	P r t	M i n	O b s	I n f o	
65040000 hex	Unit I/O Disconnection Detected for Channel 2	A disconnected input was detected for channel 2.	<ul style="list-style-type: none"> Input wiring is broken. Input wiring is disconnected. 			○	⊙		W522
65050000 hex	Unit I/O Disconnection Detected for Channel 3	A disconnected input was detected for channel 3.	<ul style="list-style-type: none"> Input wiring is broken. Input wiring is disconnected. 			○	⊙		W522
65060000 hex	Unit I/O Disconnection Detected for Channel 4	A disconnected input was detected for channel 4.	<ul style="list-style-type: none"> Input wiring is broken. Input wiring is disconnected. 			○	⊙		W522
65070000 hex	Unit I/O Disconnection Detected for Channel 5	A disconnected input was detected for channel 5.	<ul style="list-style-type: none"> Input wiring is broken. Input wiring is disconnected. 			○	⊙		W522
65080000 hex	Unit I/O Disconnection Detected for Channel 6	A disconnected input was detected for channel 6.	<ul style="list-style-type: none"> Input wiring is broken. Input wiring is disconnected. 			○	⊙		W522
65090000 hex	Unit I/O Disconnection Detected for Channel 7	A disconnected input was detected for channel 7.	<ul style="list-style-type: none"> Input wiring is broken. Input wiring is disconnected. 			○	⊙		W522
650A0000 hex	Unit I/O Disconnection Detected for Channel 8	A disconnected input was detected for channel 8.	<ul style="list-style-type: none"> Input wiring is broken. Input wiring is disconnected. 			○	⊙		W522



Event code	Event name	Meaning	Assumed cause	Level					Reference
				M a j	P r t	M i n	O b s	I n f o	
80200000 hex	NX Unit I/O Communications Error	An I/O communications error occurred in an NX Unit.	<p>For the NX bus of CPU Units</p> <ul style="list-style-type: none"> An error that prevents normal NX bus communications occurred in a CPU Unit. An NX Unit is not mounted properly. The power cable for the Unit power supply is disconnected, or the wiring from the Unit power supply to the NX Units is incorrect. The power cable for the Unit power supply is broken. The voltage of the Unit power supply is outside the specified range, or the capacity of the Unit power supply is insufficient. There is a hardware error in an NX Unit. <p>For Communications Coupler Units</p> <ul style="list-style-type: none"> An error that prevents normal NX bus communications occurred in a Communications Coupler Unit. An NX Unit is not mounted properly. The power cable for the Unit power supply is disconnected. Or, the wiring from the Unit power supply to the NX Units is incorrect. The power cable for the Unit power supply is broken. The voltage of the Unit power supply is outside the specified range. Or, the capacity of the Unit power supply is insufficient. There is a hardware error in the NX Unit. 						W522

Event code	Event name	Meaning	Assumed cause	Level					Reference
				M a j	P r t	M i n	O b s	I n f o	
80210000 hex	NX Unit Output Synchronization Error	An output synchronization error occurred in the NX Unit.	<p>For the NX bus of CPU Units</p> <ul style="list-style-type: none"> I/O refreshing on the NX bus is not performed normally due to an error in the CPU Unit. <p>For Communications Coupler Units</p> <ul style="list-style-type: none"> The communications cable connected to the Communications Coupler Unit is broken or the connection is faulty. The communications cable is affected by noise. 			○			W522
80240000 hex	NX Unit Clock Not Synchronized Error	A time information error occurred in an NX Unit.	<p>For the NX bus of CPU Units</p> <ul style="list-style-type: none"> There is a hardware error in an NX Unit. There is a hardware error in a CPU Unit. <p>For Communications Coupler Units</p> <ul style="list-style-type: none"> There is a hardware error in an NX Unit. There is a hardware error in an EtherCAT Coupler Unit. 			○			W522
64F00000 hex	Unit Over Range for Channel 1	The analog input data for input channel 1 exceeded the upper limit of the input range. Or, the analog output data for output channel 1 exceeded the upper limit of the output range.	<ul style="list-style-type: none"> The analog input data exceeded the upper limit of the input range. Or, the analog output data exceeded the upper limit of the output range. 			◉	○		W522
64F10000 hex	Unit Over Range for Channel 2	The analog input data for input channel 2 exceeded the upper limit of the input range. Or, the analog output data for output channel 2 exceeded the upper limit of the output range.	<ul style="list-style-type: none"> The analog input data exceeded the upper limit of the input range. Or, the analog output data exceeded the upper limit of the output range. 			◉	○		W522
64F20000 hex	Unit Over Range for Channel 3	The analog input data for input channel 3 exceeded the upper limit of the input range. Or, the analog output data for output channel 3 exceeded the upper limit of the output range.	<ul style="list-style-type: none"> The analog input data exceeded the upper limit of the input range. Or, the analog output data exceeded the upper limit of the output range. 			◉	○		W522

Event code	Event name	Meaning	Assumed cause	Level					Reference
				M a j	P r t	M i n	O b s	I n f o	
64F30000 hex	Unit Over Range for Channel 4	The analog input data for input channel 4 exceeded the upper limit of the input range. Or, the analog output data for output channel 4 exceeded the upper limit of the output range.	<ul style="list-style-type: none"> The analog input data exceeded the upper limit of the input range. Or, the analog output data exceeded the upper limit of the output range. 			○	○		W522
64F40000 hex	Unit Over Range for Channel 5	The analog input data for input channel 5 exceeded the upper limit of the input range. Or, the analog output data for output channel 5 exceeded the upper limit of the output range.	<ul style="list-style-type: none"> The analog input data exceeded the upper limit of the input range. Or, the analog output data exceeded the upper limit of the output range. 			○	○		W522
64F50000 hex	Unit Over Range for Channel 6	The analog input data for input channel 6 exceeded the upper limit of the input range. Or, the analog output data for output channel 6 exceeded the upper limit of the output range.	<ul style="list-style-type: none"> The analog input data exceeded the upper limit of the input range. Or, the analog output data exceeded the upper limit of the output range. 			○	○		W522
64F60000 hex	Unit Over Range for Channel 7	The analog input data for input channel 7 exceeded the upper limit of the input range. Or, the analog output data for output channel 7 exceeded the upper limit of the output range.	<ul style="list-style-type: none"> The analog input data exceeded the upper limit of the input range. Or, the analog output data exceeded the upper limit of the output range. 			○	○		W522
64F70000 hex	Unit Over Range for Channel 8	The analog input data for input channel 8 exceeded the upper limit of the input range. Or, the analog output data for output channel 8 exceeded the upper limit of the output range.	<ul style="list-style-type: none"> The analog input data exceeded the upper limit of the input range. Or, the analog output data exceeded the upper limit of the output range. 			○	○		W522



Event code	Event name	Meaning	Assumed cause	Level					Reference
				M a j	P r t	M i n	O b s	I n f o	
64F80000 hex	Unit Under Range for Channel 1	The analog input data for input channel 1 went below the lower limit of the input range. Or, the analog output data for output channel 1 went below the lower limit of the output range.	<ul style="list-style-type: none"> The analog input data went below the lower limit of the input range. Or, the analog output data went below the lower limit of the output range. 			○	○		W522
64F90000 hex	Unit Under Range for Channel 2	The analog input data for input channel 2 went below the lower limit of the input range. Or, the analog output data for output channel 2 went below the lower limit of the output range.	<ul style="list-style-type: none"> The analog input data went below the lower limit of the input range. Or, the analog output data went below the lower limit of the output range. 			○	○		W522
64FA0000 hex	Unit Under Range for Channel 3	The analog input data for input channel 3 went below the lower limit of the input range. Or, the analog output data for output channel 3 went below the lower limit of the output range.	<ul style="list-style-type: none"> The analog input data went below the lower limit of the input range. Or, the analog output data went below the lower limit of the output range. 			○	○		W522
64FB0000 hex	Unit Under Range for Channel 4	The analog input data for input channel 4 went below the lower limit of the input range. Or, the analog output data for output channel 4 went below the lower limit of the output range.	<ul style="list-style-type: none"> The analog input data went below the lower limit of the input range. Or, the analog output data went below the lower limit of the output range. 			○	○		W522
64FC0000 hex	Unit Under Range for Channel 5	The analog input data for input channel 5 went below the lower limit of the input range. Or, the analog output data for output channel 5 went below the lower limit of the output range.	<ul style="list-style-type: none"> The analog input data went below the lower limit of the input range. Or, the analog output data went below the lower limit of the output range. 			○	○		W522

Event code	Event name	Meaning	Assumed cause	Level					Reference
				M a j	P r t	M i n	O b s	I n f o	
64FD0000 hex	Unit Under Range for Channel 6	The analog input data for input channel 6 went below the lower limit of the input range. Or, the analog output data for output channel 6 went below the lower limit of the output range.	<ul style="list-style-type: none"> The analog input data went below the lower limit of the input range. Or, the analog output data went below the lower limit of the output range. 			○	○		W522
64FE0000 hex	Unit Under Range for Channel 7	The analog input data for input channel 7 went below the lower limit of the input range. Or, the analog output data for output channel 7 went below the lower limit of the output range.	<ul style="list-style-type: none"> The analog input data went below the lower limit of the input range. Or, the analog output data went below the lower limit of the output range. 			○	○		W522
64FF0000 hex	Unit Under Range for Channel 8	The analog input data for input channel 8 went below the lower limit of the input range. Or, the analog output data for output channel 8 went below the lower limit of the output range.	<ul style="list-style-type: none"> The analog input data went below the lower limit of the input range. Or, the analog output data went below the lower limit of the output range. 			○	○		W522
90400000 hex	Event Log Cleared	The event log was cleared.	<ul style="list-style-type: none"> The event log was cleared by the user. 					○	W522

● Temperature Input Units (NX-TS□□□□)

Event code	Event name	Meaning	Assumed cause	Level					Reference
				M a j	P r t	M i n	O b s	I n f o	
00200000 hex	Non-volatile Memory Hardware Error	An error occurred in non-volatile memory.	<ul style="list-style-type: none"> Non-volatile memory failure 			○			W566 (W522)
05100000 hex	A/D Converter Error	An error occurred in the A/D converter	<ul style="list-style-type: none"> Noise A/D Converter Error 			○			W566 (W522)
05110000 hex	Cold Junction Sensor Error	The temperature cannot be converted because the cold junction sensor is disconnected.	<ul style="list-style-type: none"> There is a faulty connection to the cold junction sensor. The cold junction sensor failed. 			○	⊙		W566 (W522)
10410000 hex	Control Parameter Error in Master	An error occurred in the control parameters that are saved in the master.	<p>For the NX bus of CPU Units</p> <ul style="list-style-type: none"> The power supply to the CPU Unit was turned OFF while writing the Unit operation settings was in progress. Or there is an error in the area of the non-volatile memory in the CPU Unit in which the Unit operation settings for the relevant NX Unit are saved. <p>For Communications Coupler Units</p> <ul style="list-style-type: none"> The power supply to the Communications Coupler Unit was turned OFF while writing the Unit operation settings was in progress. Or there is an error in the area of the non-volatile memory in the Communications Coupler Unit in which the Unit operation settings for the relevant NX Unit are saved. 			○			W566 (W522)
40200000 hex	NX Unit Processing Error	A fatal error occurred in an NX Unit.	<ul style="list-style-type: none"> An error occurred in the software. 			○			W566 (W522)
65100000 hex	Sensor Disconnected Error	A disconnected temperature sensor was detected.	<ul style="list-style-type: none"> The temperature sensor is damaged or the wires are broken. An unused channel is not disabled. 			○	⊙		W566 (W522)

Event code	Event name	Meaning	Assumed cause	Level					Reference
				M a j	P r t	M i n	O b s	I n f o	
80200000 hex	NX Unit I/O Communications Error	An I/O communications error occurred in an NX Unit.	<p>For the NX bus of CPU Units</p> <ul style="list-style-type: none"> An error that prevents normal NX bus communications occurred in a CPU Unit. An NX Unit is not mounted properly. The power cable for the Unit power supply is disconnected, or the wiring from the Unit power supply to the NX Units is incorrect. The power cable for the Unit power supply is broken. The voltage of the Unit power supply is outside the specified range, or the capacity of the Unit power supply is insufficient. There is a hardware error in the NX Unit. <p>For Communications Coupler Units</p> <ul style="list-style-type: none"> An error that prevents normal NX bus communications occurred in a Communications Coupler Unit. The NX Unit is not mounted properly. The power cable for the Unit power supply is disconnected. Or, the wiring from the Unit power supply to the NX Units is incorrect. The power cable for the Unit power supply is broken. The voltage of the Unit power supply is outside the specified range. Or, the capacity of the Unit power supply is insufficient. There is a hardware error in the NX Unit. 						W566 (W522)



Event code	Event name	Meaning	Assumed cause	Level					Reference
				M a j	P r t	M i n	O b s	I n f o	
80240000 hex	NX Unit Clock Not Synchronized Error	A time information error occurred in an NX Unit.	For the NX bus of CPU Units <ul style="list-style-type: none"> • There is a hardware error in an NX Unit. • There is a hardware error in a CPU Unit. For Communications Coupler Units <ul style="list-style-type: none"> • There is a hardware error in an NX Unit. • There is a hardware error in an EtherCAT Coupler Unit. 			○			W566 (W522)
65110000 hex	Process Value Over Range	The process temperature exceeded the upper limit of temperature conversion range.	<ul style="list-style-type: none"> • The sensor is disconnected. • The sensor or the compensating cables are not wired correctly. • The sensor and the input type setting do not agree. • The range of the input type is too narrow for the temperatures that need to be measured. • An unused channel is not disabled. 			◉	○		W566 (W522)
65120000 hex	Process Value Under Range	The process temperature went below the lower limit of temperature conversion range.	<ul style="list-style-type: none"> • The sensor or the compensating cables are not wired correctly. • The sensor and the input type setting do not agree. • The range of the input type is too narrow for the temperatures that need to be measured. 			◉	○		W566 (W522)
80220000 hex	NX Message Communications Error	An error was detected in message communications and the message frame was discarded.	For the NX bus of CPU Units <ul style="list-style-type: none"> • The message communications load is high. For Communications Coupler Units <ul style="list-style-type: none"> • The message communications load is high. • The communications cable is disconnected or broken. This cause does not apply if attached information 2 is 0 (NX bus). • Message communications were cutoff in communications. 				○		W566 (W522)
90400000 hex	Event Log Cleared	The event log was cleared.	<ul style="list-style-type: none"> • The event log was cleared by the user. 				○		W566 (W522)

● Heater Burnout Detection Units (NX-HB□□□□)

Event code	Event name	Meaning	Assumed cause	Level					Reference
				M a j	P r t	M i n	O b s	I n f o	
00200000 hex	Non-volatile Memory Hardware Error	An error occurred in non-volatile memory.	<ul style="list-style-type: none"> Non-volatile memory failure 			○			W566
05100000 hex	A/D Converter Error	An error occurred in the A/D converter	<ul style="list-style-type: none"> Noise A/D Converter Error 			○			W566
10410000 hex	Control Parameter Error in Master	An error occurred in the control parameters that are saved in the master.	<p>For the NX bus of CPU Units</p> <ul style="list-style-type: none"> The power supply to the CPU Unit was turned OFF while writing the Unit operation settings was in progress. Or there is an error in the area of the non-volatile memory in the CPU Unit in which the Unit operation settings for the relevant NX Unit are saved. <p>For Communications Coupler Units</p> <ul style="list-style-type: none"> The power supply to the Communications Coupler Unit was turned OFF while writing the Unit operation settings was in progress. Or there is an error in the area of the non-volatile memory in the Communications Coupler Unit in which the Unit operation settings for the relevant NX Unit are saved. 			○			W566
40200000 hex	NX Unit Processing Error	A fatal error occurred in an NX Unit.	<ul style="list-style-type: none"> An error occurred in the software. 			○			W566
652C0000 hex	Heater Burnout Detected	A heater burnout was detected.	<ul style="list-style-type: none"> A heater was burned out or damaged. The setting of the Heater Burnout Detection Current is too high. A CT input that is not used is allocated to a control output in the CT Allocation setting. 			○	⊙		W566
652D0000 hex	SSR Failure Detected	An SSR failure was detected.	<ul style="list-style-type: none"> The SSR was short-circuited or damaged. The setting of the SSR Failure Detection Current is too small. A CT input that is not used is allocated to a control output in the CT Allocation setting. 			○	⊙		W566



Event code	Event name	Meaning	Assumed cause	Level					Reference
				M a j	P r t	M i n	O b s	I n f o	
80200000 hex	NX Unit I/O Communications Error	An I/O communications error occurred in an NX Unit.	<p>For the NX bus of CPU Units</p> <ul style="list-style-type: none"> An error that prevents normal NX bus communications occurred in a CPU Unit. An NX Unit is not mounted properly. The power cable for the Unit power supply is disconnected, or the wiring from the Unit power supply to the NX Units is incorrect. The power cable for the Unit power supply is broken. The voltage of the Unit power supply is outside the specified range, or the capacity of the Unit power supply is insufficient. There is a hardware error in an NX Unit. <p>For Communications Coupler Units</p> <ul style="list-style-type: none"> An error that prevents normal NX bus communications occurred in a Communications Coupler Unit. The NX Unit is not mounted properly. The power cable for the Unit power supply is disconnected. Or, the wiring from the Unit power supply to the NX Units is incorrect. The power cable for the Unit power supply is broken. The voltage of the Unit power supply is outside the specified range. Or, the capacity of the Unit power supply is insufficient. There is a hardware error in the NX Unit. 						W566

Event code	Event name	Meaning	Assumed cause	Level					Reference
				M a j	P r t	M i n	O b s	I n f o	
80240000 hex	NX Unit Clock Not Synchronized Error	A time information error occurred in an NX Unit.	For the NX bus of CPU Units <ul style="list-style-type: none"> • There is a hardware error in an NX Unit. • There is a hardware error in a CPU Unit. For Communications Coupler Units <ul style="list-style-type: none"> • There is a hardware error in an NX Unit. • There is a hardware error in an EtherCAT Coupler Unit. 			○			W566
80220000 hex	NX Message Communications Error	An error was detected in message communications and the message frame was discarded.	For the NX bus of CPU Units <ul style="list-style-type: none"> • The message communications load is high. For Communications Coupler Units <ul style="list-style-type: none"> • The message communications load is high. • The communications cable is disconnected or broken. • Message communications were cutoff in communications. 			○			W566
90400000 hex	Event Log Cleared	The event log was cleared.	<ul style="list-style-type: none"> • The event log was cleared by the user. 					○	W566



NX-series System Units

The section provides a table of the errors (events) that can occur in the following Units.

NX-PD1□□□

NX-PF0□□□

NX-PC0□□□

NX-TBX01

The manual names are given below for the catalog numbers given in the Reference column of the event table.

Cat. No.	Manual name
W523	NX-series System Unit User's Manual

Event code	Event name	Meaning	Assumed cause	Level					Reference
				M a j	P r t	M i n	O b s	I n f o	
00200000 hex	Non-volatile Memory Hardware Error	An error occurred in non-volatile memory.	<ul style="list-style-type: none"> Non-volatile memory failure 			○			W523
90400000 hex	Event Log Cleared	The event log was cleared.	<ul style="list-style-type: none"> The event log was cleared by the user. 					○	W523

NX-series Position Interface Units

The section provides a table of the errors (events) that can occur in the following Units.

NX-EC0□□□

NX-ECS□□□

NX-PG0□□□

The manual names are given below for the catalog numbers given in the Reference column of the event table.

Cat. No.	Manual name
W524	NX-series Position Interface Units User's Manual

Event code	Event name	Meaning	Assumed cause	Level					Reference
				M a j	P r t	M i n	O b s	I n f o	
00200000 hex	Non-volatile Memory Hardware Error	An error occurred in non-volatile memory.	<ul style="list-style-type: none"> Non-volatile memory failure 			○			W524
10410000 hex	Control Parameter Error in Master	An error occurred in the control parameters that are saved in the master.	<p>For the NX bus of CPU Units</p> <ul style="list-style-type: none"> The power supply to the CPU Unit was turned OFF while writing the Unit operation settings was in progress. Or there is an error in the area of the non-volatile memory in the CPU Unit in which the Unit operation settings for the relevant NX Unit are saved. <p>For Communications Coupler Units</p> <ul style="list-style-type: none"> The power supply to the Communications Coupler Unit was turned OFF while writing the Unit operation settings was in progress. Or there is an error in the area of the non-volatile memory in the Communications Coupler Unit in which the Unit operation settings for the relevant NX Unit are saved. 			○			W524
35100000 hex	External Input Setting Error	A setting for an external input is not correct.	<ul style="list-style-type: none"> The same function (other than a general-purpose input) is assigned to more than one of the external inputs (I0 to I2). 			○			W524

A

Event code	Event name	Meaning	Assumed cause	Level					Reference
				M a j	P r t	M i n	O b s	I n f o	
35110000 hex	SSI Data Setting Error	There is an error in the SSI data settings.	<ul style="list-style-type: none"> The sum of the values set for the Valid Data Length and the Leading Bits parameters exceeds 32. The sum of the values set for the Multi-turn Data Length, Single- turn Data Length, and the Status Data Length parameters exceeds 32. The sum of the value set for the start bit position and the data length of the SSI data exceeds the value set for the Valid Data Length parameter. The value set for the Encoder Resolution parameter exceeds the range expressed by the data length set for the Single-turn Data Length parameter. 			○			W524
40200000 hex	NX Unit Processing Error	A fatal error occurred in an NX Unit.	<ul style="list-style-type: none"> An error occurred in the software. 			○			W524
743D0000 hex	Incorrect Synchronization Command	Updating the target position data in the synchronization refresh failed consecutively for more than the specified number of times.	<ul style="list-style-type: none"> The communications cable that connects the Communications Coupler Unit is disconnected or a connection is faulty. Noise 			○	⊙		W524
743E0000 hex	Illegal Following Error	The difference between the command position and actual position exceeds the range expressed by 29 bits.	<ul style="list-style-type: none"> A command that exceeded the maximum velocity (for a model that allows maximum velocity setting, the set value applies to this maximum velocity) was output continuously, so the following error for the actual output, which is restricted by the maximum velocity, has increased. A command velocity that does not correspond to the command position was specified when a velocity-continuous pulse output was used, so the number of pulses that were actually output for the updated command position has increased. 			○			W524

Event code	Event name	Meaning	Assumed cause	Level					Reference
				M a j	P r t	M i n	O b s	I n f o	
743F0000 hex	Illegal State Transition	The EtherCAT master or EtherCAT Coupler Unit executed a command to change the communications status when the Pulse Output Unit is in the Operation Enabled status.	<ul style="list-style-type: none"> A communications command to change the current communications status was received from the communications master while the Unit is in the Operation Enabled status. 			○			W524
80200000 hex	NX Unit I/O Communications Error	An I/O communications error occurred in an NX Unit.	<p>For the NX bus of CPU Units</p> <ul style="list-style-type: none"> An error that prevents normal NX bus communications occurred in a CPU Unit. An NX Unit is not mounted properly. The power cable for the Unit power supply is disconnected, or the wiring from the Unit power supply to the NX Units is incorrect. The power cable for the Unit power supply is broken. The voltage of the Unit power supply is outside the specified range, or the capacity of the Unit power supply is insufficient. There is a hardware error in an NX Unit. <p>For Communications Coupler Units</p> <ul style="list-style-type: none"> An error that prevents normal NX bus communications occurred in a Communications Coupler Unit. The NX Unit is not mounted properly. The power cable for the Unit power supply is disconnected. Or, the wiring from the Unit power supply to the NX Units is incorrect. The power cable for the Unit power supply is broken. The voltage of the Unit power supply is outside the specified range. Or, the capacity of the Unit power supply is insufficient. There is a hardware error in an NX Unit. 			○			W524



Event code	Event name	Meaning	Assumed cause	Level					Reference
				M a j	P r t	M i n	O b s	I n f o	
80210000 hex	NX Unit Output Synchronization Error	An output synchronization error occurred in the NX Unit.	<p>For the NX bus of CPU Units</p> <ul style="list-style-type: none"> I/O refreshing on the NX bus is not performed normally due to an error in the CPU Unit. <p>For Communications Coupler Units</p> <ul style="list-style-type: none"> The communications cable connected to the Communications Coupler Unit is broken or the connection is faulty. The communications cable is affected by noise. 			○			W524
80240000 hex	NX Unit Clock Not Synchronized Error	A time information error occurred in an NX Unit.	<p>For the NX bus of CPU Units</p> <ul style="list-style-type: none"> There is a hardware error in an NX Unit. There is a hardware error in a CPU Unit. <p>For Communications Coupler Units</p> <ul style="list-style-type: none"> There is a hardware error in an NX Unit. There is a hardware error in an EtherCAT Coupler Unit. 			○			W524
80220000 hex	NX Message Communications Error	An error was detected in message communications and the message frame was discarded.	<p>For the NX bus of CPU Units</p> <ul style="list-style-type: none"> The message communications load is high. <p>For Communications Coupler Units</p> <ul style="list-style-type: none"> The message communications load is high. The communications cable is disconnected or broken. Message communications were cutoff in communications. 				○		W524
84D00000 hex	SSI Communications Error	An error occurred in SSI communications.	<ul style="list-style-type: none"> The SSI data settings do not agree with the SSI communications settings in the connected device. The wiring between the NX Unit and the connected device is not correct or disconnected. Noise 			○	○		W524
90400000 hex	Event Log Cleared	The event log was cleared.	<ul style="list-style-type: none"> The event log was cleared by the user. 					○	W524

NX-series Communications Interface Units

The section provides a table of the errors (events) that can occur in the following Units.
NX-CIF□□□

The manual names are given below for the catalog numbers given in the Reference column of the event table.

Cat. No.	Manual name
W540	NX-series Communications Interface Units User's Manual

Event code	Event name	Meaning	Assumed cause	Level					Reference
				M a j	P r t	M i n	O b s	I n f o	
00200000 hex	Non-volatile Memory Hardware Error	An error occurred in non-volatile memory.	<ul style="list-style-type: none"> Non-volatile memory failure 			○			W540
10410000 hex	Control Parameter Error in Master	An error occurred in the control parameters that are saved in the master.	<p>For the NX bus of CPU Units</p> <ul style="list-style-type: none"> The power supply to the CPU Unit was turned OFF while writing the Unit operation settings was in progress. Or there is an error in the area of the non-volatile memory in the CPU Unit in which the Unit operation settings for the relevant NX Unit are saved. <p>For Communications Coupler Units</p> <ul style="list-style-type: none"> The power supply to the Communications Coupler Unit was turned OFF while writing the Unit operation settings was in progress. Or there is an error in the area of the non-volatile memory in the Communications Coupler Unit in which the Unit operation settings for the relevant NX Unit are saved. 			○			W540
40200000 hex	NX Unit Processing Error	A fatal error occurred in an NX Unit.	<ul style="list-style-type: none"> An error occurred in the software. 			○			W540

A

Event code	Event name	Meaning	Assumed cause	Level					Reference
				M a j	P r t	M i n	O b s	I n f o	
80200000 hex	NX Unit I/O Communications Error	An I/O communications error occurred in an NX Unit.	<p>For the NX bus of CPU Units</p> <ul style="list-style-type: none"> • An error that prevents normal NX bus communications occurred in a CPU Unit. • An NX Unit is not mounted properly. • The power cable for the Unit power supply is disconnected, or the wiring from the Unit power supply to the NX Units is incorrect. • The power cable for the Unit power supply is broken. • The voltage of the Unit power supply is outside the specified range, or the capacity of the Unit power supply is insufficient. • There is a hardware error in an NX Unit. <p>For Communications Coupler Units</p> <ul style="list-style-type: none"> • An error that prevents normal NX bus communications occurred in a Communications Coupler Unit. • The NX Unit is not mounted properly. • The power cable for the Unit power supply is disconnected. Or, the wiring from the Unit power supply to the NX Units is incorrect. • The power cable for the Unit power supply is broken. • The voltage of the Unit power supply is outside the specified range. Or, the capacity of the Unit power supply is insufficient. • There is a hardware error in an NX Unit. 						W540

Event code	Event name	Meaning	Assumed cause	Level					Reference
				M a j	P r t	M i n	O b s	I n f o	
80240000 hex	NX Unit Clock Not Synchronized Error	A time information error occurred in an NX Unit.	For the NX bus of CPU Units <ul style="list-style-type: none"> • There is a hardware error in an NX Unit. • There is a hardware error in a CPU Unit. For Communications Coupler Units <ul style="list-style-type: none"> • There is a hardware error in an NX Unit. • There is a hardware error in an EtherCAT Coupler Unit. 				○		W540
85400000 hex	Data Discarded Due to Full Internal Buffer	The internal buffer is full. The input data is discarded.	<ul style="list-style-type: none"> • If the internal buffer for received data is full, the Controller cannot read the received data. • If the internal buffer for transmission data is full, the transmission data was too large or there are too many send requests. 				○	⊙	W540
80220000 hex	NX Message Communications Error	An error was detected in message communications and the message frame was discarded.	For the NX bus of CPU Units <ul style="list-style-type: none"> • The message communications load is high. For Communications Coupler Units <ul style="list-style-type: none"> • The message communications load is high. • The communications cable is disconnected or broken. • Message communications were cutoff in communications. 					○	W540
85410000 hex	Parity Error	A parity error occurred.	<ul style="list-style-type: none"> • The communications settings and baud rate setting do not agree with those of the remote device. • Noise 				⊙	○	W540
85420000 hex	Framing Error	A framing error occurred.	<ul style="list-style-type: none"> • The communications settings and baud rate setting do not agree with those of the remote device. • Noise 				⊙	○	W540
85430000 hex	Overrun Error	An overrun error occurred.	<ul style="list-style-type: none"> • The next data was received during processing of received data because the baud rate is too high. 				⊙	○	W540
90400000 hex	Event Log Cleared	The event log was cleared.	<ul style="list-style-type: none"> • The event log was cleared by the user. 					○	W540

NX-series Safety CPU Units

The section provides a table of the errors (events) that can occur in the following Safety Control Units.

NX-SL5□□□

NX-SL3□□□

The manual names are given below for the catalog numbers given in the Reference column of the event table.

Cat. No.	Manual name
Z930	NX-series Safety Control Unit User's Manual

● System Error

Event code	Event name	Meaning	Assumed cause	Level					Reference
				M a j	P r t	M i n	O b s	I n f o	
05200000 hex	System Error	A hardware error was detected during self-diagnosis of the hardware.	<ul style="list-style-type: none"> Hardware has failed. A memory error occurred due to a transient cause, such as a soft error or excessive noise. 			○			Z930

● Communications Errors

Event code	Event name	Meaning	Assumed cause	Level					Reference
				M a j	P r t	M i n	O b s	I n f o	
35200000 hex	Safety Process Data Communications Not Established Error	Safety process data communications was not established with one or more safety slaves.	<ul style="list-style-type: none"> The communications settings for safety process data are not correct, the safety slave is not in the correct status, etc. The safety slave for safety process data communications is not connected. The NX Unit Mounting Setting for the safety slave for safety process data communications is set to Disabled. 			○			Z930
35200001 hex	FSoE Master Connection Not Established Error	FSoE communications were not established with the FSoE slave.	<ul style="list-style-type: none"> The FSoE communications settings are not correct, the FSoE slave is not in the correct status, etc. The FSoE slave for FSoE communications is not connected. The FSoE slave set in the NX Unit Mounting Setting for FSoE communications is disabled. The version of the FSoE slave to be communicated is older than the configured version. 			○			Z930

Event code	Event name	Meaning	Assumed cause	Level					Reference
				M a j	P r t	M i n	O b s	I n f o	
80200000 hex	NX Unit I/O Communications Error	An I/O communications error occurred in an NX Unit.	<p>NX Bus of the CPU Unit</p> <ul style="list-style-type: none"> An error occurred in the CPU Unit, which prevents the NX bus communications from being carried out normally. The NX Unit is not mounted properly. The power cable for the Unit power supply is disconnected. Or, the wiring from the Unit power supply to the NX Units is incorrect. The power cable for the Unit power supply is broken. The Unit power voltage is out of the supported range, or the Unit power capacity is not sufficient. There is a hardware error in the NX Unit. <p>Communications Coupler Unit</p> <ul style="list-style-type: none"> An error occurred in the Communications Coupler Unit, which prevents the NX bus communications from being carried out normally. The NX Unit is not mounted properly. The power cable for the Unit power supply is disconnected. Or, the wiring from the Unit power supply to the NX Units is incorrect. The power cable for the Unit power supply is broken. The Unit power voltage is out of the supported range, or the Unit power capacity is not sufficient. There is a hardware error in the NX Unit. 			○			Z930



Event code	Event name	Meaning	Assumed cause	Level					Reference
				M a j	P r t	M i n	O b s	I n f o	
80300000 hex	Safety Process Data Communications Timeout	A communications timeout occurred in safety process data communications with the Safety Control Unit.	<ul style="list-style-type: none"> • A setting is not correct. The setting of the safety task period is too short. • There is excessive noise. • The Safety CPU Unit or safety slave entered a status where it could not continue safety process data communications. • An error or status change occurred in the NX Bus Master to which the Unit is connected, preventing correct process data communications. 			○			Z930
80300001 hex	FSoE Master Connection Timeout	A communication timeout occurred in FSoE communications with the FSoE slave.	<ul style="list-style-type: none"> • A setting is not correct. The setting of the safety task period is too short. • There is excessive noise. • The Safety CPU Unit or FSoE slave entered a state where it could not continue FSoE communications. • The process data communications were not performed correctly because an error or status change occurred in the NX bus master to which the Unit is connected. 			○			Z930



Event code	Event name	Meaning	Assumed cause	Level					Reference
				M a j	P r t	M i n	O b s	I n f o	
80310000 hex	CIP Safety Originator Connection Not Established Error	CIP safety originator connection was not established.	<ul style="list-style-type: none"> The target node is different. The target node is not configured. The target node status is invalid. The Do not use Option is selected for CIP message server setting in the EtherNet/IP Port Settings. The settings of the NX-series CPU Unit and NX-series EtherNet/IP Unit related to CIP Safety communications do not match the settings of the Safety CPU Unit. Setting to use tag data link communications was made to the NX-series EtherNet/IP Unit that is included in the CIP Safety connection settings. The NX-series EtherNet/IP Unit with tag data link communications was added to the CIP Safety connection settings. The Do not use Option is selected for CIP Safety communications in the Built-in EtherNet/IP Port Settings. 			○			Z930
80320000 hex	CIP Safety Originator Connection Timeout	A timeout occurred in CIP safety originator connection.	<ul style="list-style-type: none"> The communications cable is disconnected or broken. The target node entered a state where it could not accept the connection. The timeout value in the communications setup is too small. CIP message communications at the target node are stopped. When the Packet Filter function is enabled in the EtherNet/IP Port Settings, CIP Safety packets from the target node are not allowed. CIP Safety packets are not allowed by the Packet Filter (Simple) or Packet Filter functions on the target node or the devices on the communication path. There is excessive noise. 			○			Z930

Event code	Event name	Meaning	Assumed cause	Level					Reference
				M a j	P r t	M i n	O b s	I n f o	
80330000 hex	CIP Safety Target Does Not Exist	The target node does not exist.	<ul style="list-style-type: none"> The communications cable is disconnected or broken. The target node entered a state where it could not accept the connection. The timeout value in the communications setup is too small. CIP message communications at the target node are stopped. CIP Safety packets from the originator node are not allowed by the Packet Filter (Simple) or Packet Filter functions on the target node or the devices on the communication path. There is excessive noise. 			○			Z930
80340000 hex	CIP Safety Target Connection Timeout	A timeout occurred in the CIP Safety Target connection.	<ul style="list-style-type: none"> The communications cable is disconnected or broken. The originator device entered a state where it could not accept the connection. The timeout value for the communications settings is too small. CIP Safety packets from the originator node are not allowed by the Packet Filter (Simple) or Packet Filter functions in the EtherNet/IP Port Settings or on the devices on the communication path. The CIP message server setting for the originator node is set to Do not use. When the Packet Filter function of the originator node is enabled, CIP Safety packets from the target node are not allowed. There is excessive noise. The Do not use Option is selected for CIP Safety communications in the Built-in EtherNet/IP Port Settings. 			○			Z930
84F00000 hex	NX Bus I/O Communications Stopped	An error occurred in I/O communications between the NX bus master and an NX Unit.	<ul style="list-style-type: none"> There is a hardware error in the NX bus master or an NX Unit. 			○			Z930

● Operation Continuation Error Related to Program Execution Function

Event code	Event name	Possible settings	Assumed cause	Level					Reference
				M a j	P r t	M i n	O b s	I n f o	
74A00000 hex	SF_Antivalent Error	An error was detected in execution of a safety function block.	Refer to information on the diagnostic code that is given for attached information 1 in the <i>NX-series Safety ControlUnit InstructionsReference Manual (Cat No. Z931)</i> .			○			Z930
74A10000 hex	SF_EDM Error	An error was detected in execution of a safety function block.	Refer to information on the diagnostic code that is given for attached information 1 in the <i>NX-series Safety ControlUnit InstructionsReference Manual (Cat No. Z931)</i> .			○			Z930
74A20000 hex	SF_EmergencyStop Error	An error was detected in execution of a safety function block.	Refer to information on the diagnostic code that is given for attached information 1 in the <i>NX-series Safety ControlUnit InstructionsReference Manual (Cat No. Z931)</i> .			○			Z930
74A30000 hex	SF_Enable-Switch Error	An error was detected in execution of a safety function block.	Refer to information on the diagnostic code that is given for attached information 1 in the <i>NX-series Safety ControlUnit InstructionsReference Manual (Cat No. Z931)</i> .			○			Z930
74A40000 hex	SF_Equivalent Error	An error was detected in execution of a safety function block.	Refer to information on the diagnostic code that is given for attached information 1 in the <i>NX-series Safety ControlUnit InstructionsReference Manual (Cat No. Z931)</i> .			○			Z930
74A50000 hex	SF_ESPE Error	An error was detected in execution of a safety function block.	Refer to information on the diagnostic code that is given for attached information 1 in the <i>NX-series Safety ControlUnit InstructionsReference Manual (Cat No. Z931)</i> .			○			Z930
74A60000 hex	SF_GuardLocking Error	An error was detected in execution of a safety function block.	Refer to information on the diagnostic code that is given for attached information 1 in the <i>NX-series Safety ControlUnit InstructionsReference Manual (Cat No. Z931)</i> .			○			Z930
74A70000 hex	SF_Guard-Monitoring Error	An error was detected in execution of a safety function block.	Refer to information on the diagnostic code that is given for attached information 1 in the <i>NX-series Safety ControlUnit InstructionsReference Manual (Cat No. Z931)</i> .			○			Z930

A-2 Errors (Events) That Can Occur in Connected Devices

A

A-2-1 Errors in Slave Terminals

Event code	Event name	Possible settings	Assumed cause	Level					Reference
				M a j	P r t	M i n	O b s	I n f o	
74A80000 hex	SF_Mode-Selector Error	An error was detected in execution of a safety function block.	Refer to information on the diagnostic code that is given for attached information 1 in the <i>NX-series Safety ControlUnit InstructionsReference Manual (Cat No. Z931)</i> .			○			Z930
74A90000 hex	SF_Muting-Par Error	An error was detected in execution of a safety function block.	Refer to information on the diagnostic code that is given for attached information 1 in the <i>NX-series Safety ControlUnit InstructionsReference Manual (Cat No. Z931)</i> .			○			Z930
74AA0000 hex	SF_Muting-Par_2Sensor Error	An error was detected in execution of a safety function block.	Refer to information on the diagnostic code that is given for attached information 1 in the <i>NX-series Safety ControlUnit InstructionsReference Manual (Cat No. Z931)</i> .			○			Z930
74AB0000 hex	SF_Muting-Seq Error	An error was detected in execution of a safety function block.	Refer to information on the diagnostic code that is given for attached information 1 in the <i>NX-series Safety ControlUnit InstructionsReference Manual (Cat No. Z931)</i> .			○			Z930
74AC0000 hex	SF_OutControl Error	An error was detected in execution of a safety function block.	Refer to information on the diagnostic code that is given for attached information 1 in the <i>NX-series Safety ControlUnit InstructionsReference Manual (Cat No. Z931)</i> .			○			Z930
74AD0000 hex	SF_SafetyRequest Error	An error was detected in execution of a safety function block.	Refer to information on the diagnostic code that is given for attached information 1 in the <i>NX-series Safety ControlUnit InstructionsReference Manual (Cat No. Z931)</i> .			○			Z930
74AE0000 hex	SF_TestableSafety-Sensor Error	An error was detected in execution of a safety function block.	Refer to information on the diagnostic code that is given for attached information 1 in the .			○			Z930
74AF0000 hex	SF_Two-HandControlTypeII Error	An error was detected in execution of a safety function block.	Refer to information on the diagnostic code that is given for attached information 1 in the <i>NX-series Safety ControlUnit InstructionsReference Manual (Cat No. Z931)</i> .			○			Z930
74B00000 hex	SF_Two-HandControlTypeIII Error	An error was detected in execution of a safety function block.	Refer to information on the diagnostic code that is given for attached information 1 in the <i>NX-series Safety ControlUnit InstructionsReference Manual (Cat No. Z931)</i> .			○			Z930

● Operation Stop Error Related to Program Execution

Event code	Event name	Possible settings	Assumed cause	Level					Reference
				M a j	P r t	M i n	O b s	I n f o	
55000000 hex	Division by Zero	Division by zero was detected.	The divisor is zero.			○			Z930
55010000 hex	Cast Error	A casting error was detected.	A value was input that exceeded the range of the receiving variable.			○			Z930
55020000 hex	MUX Error	An MUX instruction error was detected.	The value of the selection input (K) to the MUX instruction is not correct.			○			Z930

● Setting Error

Event code	Event name	Possible settings	Assumed cause	Level					Reference
				M a j	P r t	M i n	O b s	I n f o	
10500000 hex	NX Bus Communications Settings Read Error	There is an error in the NX Bus communications settings that are saved in non-volatile memory.	<ul style="list-style-type: none"> A hardware failure occurred in the non-volatile memory. Power was turned OFF while saving data to the non-volatile memory. 			○			Z930
10510000 hex	Safety Application Data Read Error	There is an error in the safety application data that is saved in non-volatile memory.	<ul style="list-style-type: none"> A hardware failure occurred in the non-volatile memory. Power was turned OFF while saving data to the non-volatile memory. 			○			Z930
10520000 hex	NX Bus Communications Settings and Safety Application Data Mismatch	There is an error in the safety application data that is saved in non-volatile memory.	<ul style="list-style-type: none"> The NX bus communications settings that were transferred to the Safety CPU Unit do not match the safety application data. 			○			Z930
10530000 hex	Non-volatile Memory Access Error	Reading/writing non-volatile memory failed.	Non-volatile memory failure.			○			Z930
24AA0000 hex	DIP Switch Setting Error	The DIP switch setting is invalid.	<ul style="list-style-type: none"> The DIP switch setting was changed. 				○		Z930

A

● Restore Function Errors

Event code	Event name	Meaning	Assumed cause	Level					Reference
				M a j	P r t	M i n	O b s	I n f o	
35250000 hex	Safety Unit Restore Operation Failed to Start (SD Memory Card Access Failed)	Access to the SD Memory Card failed when you start the restore operation for a Safety Unit.	<ul style="list-style-type: none"> An SD Memory Card is not inserted. The SD Memory Card type is not correct. The format of the SD Memory Card is not correct. The SD Memory Card is damaged. 				○		Z930
35260000 hex	Safety Unit Restore Operation Failed to Start (Safety Unit Restore File Read Failure)	Reading the Safety Unit Restore File failed.	<ul style="list-style-type: none"> The Safety Unit Restore File is not stored in the specified folder. The Safety Unit Restore File is corrupted. 				○		Z930
35270000 hex	Safety Unit Restore Operation Failed to Start (Model Mismatch)	A model mismatch was detected during pre-execution checks for a restore operation for a Safety Unit.	<ul style="list-style-type: none"> The restore operation for a Safety Unit was performed on an incorrect Unit. An incorrect Safety Unit Restore File was used. 				○		Z930
35280000 hex	Safety Unit Restore Operation Failed to Start (Version Mismatch)	A version mismatch was detected during pre-execution checks for a restore operation for a Safety Unit.	<ul style="list-style-type: none"> The restore operation for a Safety Unit was performed on an incompatible unit. An incorrect Safety Unit Restore File was used. 				○		Z930
35290000 hex	Safety Unit Restore Operation Failed to Start (Node Name Mismatch)	A node name mismatch was detected during pre-execution checks for a restore operation for a Safety Unit.	<ul style="list-style-type: none"> The restore operation for a Safety Unit was performed on an incorrect Unit. An incorrect Safety Unit Restore File was used. The node name specified when the Safety Unit Restore File was generated is incorrect. 				○		Z930
352A0000 hex	Safety Unit Restore Operation Failed to Start (Safety Password Mismatch)	A safety password mismatch was detected during pre-execution checks for a restore operation for a Safety Unit.	<ul style="list-style-type: none"> The restore operation for a Safety Unit was performed on an incorrect Unit. An incorrect Safety Unit Restore File was used. The safety password specified when the Safety Unit Restore File was generated is incorrect. 				○		Z930

Event code	Event name	Meaning	Assumed cause	Level					Reference
				M a j	P r t	M i n	O b s	I n f o	
352B0000 hex	Safety Unit Restore Operation Failed	The restore operation for a Safety Unit ended in an error.	<ul style="list-style-type: none"> The SD Memory Card was removed during a restore operation for a Safety Unit. Data was read from or written to the SD Memory Card via the Support Software or an FTP client during a restore operation for a Safety Unit. 				○		Z930

● Other Errors

Event code	Event name	Meaning	Assumed cause	Level					Reference
				M a j	P r t	M i n	O b s	I n f o	
80220000 hex	NX Message Communications Error	An error was detected in message communications for an NX Unit and the message frame was discarded.	<ul style="list-style-type: none"> The message communications load is high. The communications cable is disconnected or broken. This cause does not apply if attached information 2 is 0 (NX bus). Message communications were cut off as the result of executing a synchronization or restoration operation on the Sysmac Studio or as the result of disconnecting an EtherCAT slave. 				○		Z930
951E0000 hex	Sysmac Studio Communications Connection Timeout	A communications timeout occurred between the Sysmac Studio and the Safety CPU Unit.	<ul style="list-style-type: none"> The communications cable was disconnected. 				○		Z930
951F0000 hex	Clear All Memory Rejected	Clearing all of memory failed.	<ul style="list-style-type: none"> The Clear All Memory operation for a Controller or a Slave Terminal was performed. 				○		Z930

● User Access Log

Event code	Event name	Meaning	Assumed cause	Level					Reference
				M a j	P r t	M i n	O b s	I n f o	
90400000 hex	Event Log Cleared	The event log was cleared.	<ul style="list-style-type: none"> The event log was cleared by the user. 				○		Z930
90430000 hex	Memory All Cleared	The Unit settings were cleared.	<ul style="list-style-type: none"> The Clear All Memory operation was performed. 				○		Z930

NX-series Safety I/O Units (NX-SI□□□□/NX-SO□□□□)

The section provides a table of the errors (events) that can occur in the following Safety Control Units.

NX-SI□□□□

NX-SO□□□□

The manual names are given below for the catalog numbers given in the Reference column of the event table.

Cat. No.	Manual name
Z930	NX-series Safety Control Unit User's Manual

● System Error

Event code	Event name	Meaning	Assumed cause	Level					Reference
				M a j	P r t	M i n	O b s	I n f o	
05200000 hex	System Error	A hardware error was detected during self-diagnosis of the hardware.	<ul style="list-style-type: none"> Hardware has failed. A memory error occurred due to a transient cause, such as a soft error or excessive noise. 			○			Z930

● Communications Errors

Event code	Event name	Meaning	Assumed cause	Level					Reference
				M a j	P r t	M i n	O b s	I n f o	
35210000 hex	Safety Process Data Communications Not Established - Incorrect Unit Parameter Error	Safety process data communications was not established with the Safety CPU Unit.	<ul style="list-style-type: none"> The model or safety I/O terminal settings are not correct. 			○			Z930
35230000 hex	Safety Process Data Communications Not Established, Incorrect FSoE Slave Address Error	Safety process data communications was not established with the Safety CPU Unit because of an incorrect FSoE slave address.	<ul style="list-style-type: none"> The setting of the FSoE slave address in the safety process data communications settings is different from the setting in the Unit. 			○			Z930
35240000 hex	Safety Process Data Communications Not Established, Incorrect Frame Error	Safety process data communications were not established with the Safety CPU Unit because an incorrect frame was received.	<ul style="list-style-type: none"> An incorrect frame was received in safety process data communications. There is excessive noise. 			○			Z930

Event code	Event name	Meaning	Assumed cause	Level					Reference
				M a j	P r t	M i n	O b s	I n f o	
80200000 hex	NX Unit I/O Communications Error	An I/O communications error occurred between the NX bus master and the NX Unit.	<ul style="list-style-type: none"> The NX Unit is not mounted properly. The power cable for the Unit power supply is disconnected. Or, the wiring from the Unit power supply to the NX Units is incorrect. The power cable for the Unit power supply is broken. The unit power voltage is out of the supported range, or the unit power capacity is not sufficient. There is a hardware error in the NX Unit. 			○			Z930
80300000 hex	Safety Process Data Communications Timeout	A communications timeout occurred in safety process data communications with the Safety Control Unit.	<ul style="list-style-type: none"> A setting is not correct. The setting of the safety task period is too short. There is excessive noise. The Safety CPU Unit or safety slave entered a status where it could not continue safety process data communications. The process data communications were not performed correctly because an error or status change occurred in the NX bus master to which the Unit is connected. 			○			Z930
84F10000 hex	NX Bus I/O Communications Stopped	An error occurred in I/O communications between the NX bus master and an NX Unit.	There is a hardware error in the NX bus master or an NX Unit.			○			Z930

● Safety I/O Errors

Event code	Event name	Meaning	Assumed cause	Level					Reference
				M a j	P r t	M i n	O b s	I n f o	
05210000 hex	Internal Circuit Error at Safety Input	A fault was detected in the internal circuit for the safety input terminal.	<ul style="list-style-type: none"> The internal circuit for the safety input terminal is faulty. A memory error or signal error occurred due to a transient cause, such as an excessive noise. 			○			Z930

Event code	Event name	Meaning	Assumed cause	Level					Reference
				M a j	P r t	M i n	O b s	I n f o	
05220000 hex	Internal Circuit Error at Test Output	A fault was detected in the internal circuit for the test output terminal.	<ul style="list-style-type: none"> The internal circuit for the test output terminal is faulty. A memory error or signal error occurred due to a transient cause, such as an excessive noise. 			○			Z930
05230000 hex	Internal Circuit Error at Safety Output	A fault was detected in the internal circuit for the safety output terminal.	<ul style="list-style-type: none"> The internal circuit for the safety output terminal is faulty. A memory error or signal error occurred due to a transient cause, such as an excessive noise. 			○			Z930
65200000 hex	I/O Power Supply Voltage Error	An incorrect I/O power supply voltage was detected.	<ul style="list-style-type: none"> The input power or output power is not supplied correctly. 			○			Z930
65210000 hex	Output Power Interrupt Circuit Error	An error was detected by the output power interruption test.	<ul style="list-style-type: none"> The wiring is not correct or there is a fault in the hardware. 			○			Z930
65220000 hex	External Test Signal Failure at Safety Input	An error was detected in test pulse evaluation of the safety input terminals.	<ul style="list-style-type: none"> The positive power supply wire is in contact with the input signal line. The input signal lines are shorted. The external device is faulty. 			○			Z930
65230000 hex	Discrepancy Error at Safety Input	An error was detected in discrepancy evaluation of safety input terminals.	<ul style="list-style-type: none"> There is a ground fault or disconnection in the input signal line. The connected device is faulty. The setting of the discrepancy time is not correct. Chattering occurred in the input signal from the external input device, such as a safety door. 			○			Z930
65240000 hex	Overload Detected at Test Output	An overcurrent was detected at the test output terminal.	<ul style="list-style-type: none"> There is a ground fault on the output signal line. The external device is faulty. 			○			Z930
65250000 hex	Stuck-at-high Detected at Test Output	It was detected that the test output terminal is stuck ON.	<ul style="list-style-type: none"> The positive power supply line is in contact with the output signal line. The internal circuit is faulty. A memory error or signal error occurred due to a transient cause, such as a soft error or excessive noise. 			○			Z930
65270000 hex	Short Circuit Detected at Safety Output	A ground fault was detected on the safety output terminal.	<ul style="list-style-type: none"> There is a ground fault on the output signal line. 			○			Z930

Event code	Event name	Meaning	Assumed cause	Level					Reference
				M a j	P r t	M i n	O b s	I n f o	
65280000 hex	Stuck-at-high Detected at Safety Output	It was detected that the safety output terminal is stuck ON.	<ul style="list-style-type: none"> The positive power supply line is in contact with the output signal line. The output power supply is outside the specifications. The internal circuit is faulty. A memory error or signal error occurred due to a transient cause, such as a soft error or excessive noise. 			○			Z930

● Other Errors

Event code	Event name	Meaning	Assumed cause	Level					Reference
				M a j	P r t	M i n	O b s	I n f o	
80220000 hex	NX Message Communications Error	An error was detected in message communications for an NX Unit and the message frame was discarded.	<ul style="list-style-type: none"> The message communications load is high. The communications cable is disconnected or broken. Message communications were cut off as the result of executing a synchronization or restoration operation on the Sysmac Studio or as the result of disconnecting an EtherCAT slave. 				○		Z930

● User Access Log

Event code	Event name	Meaning	Assumed cause	Level					Reference
				M a j	P r t	M i n	O b s	I n f o	
90400000 hex	Event Log Cleared	The event log was cleared.	The event log was cleared by the user.					○	Z930
90430000 hex	Memory All Cleared	The Unit settings were cleared.	The Clear All Memory operation was performed.					○	Z930

A

NX-series Load Cell Input Units

The section provides a table of errors (events) that can occur in the following Unit.

NX-RS□□□□

The manual names are given below for the catalog numbers given in the Reference column of the event table.

Cat. No.	Manual name
W565	NX-series Load Cell Input Unit User's Manual

Event code	Event name	Meaning	Assumed cause	Level					Reference
				M a j	P r t	M i n	O b s	I n f o	
00200000 hex	Non-volatile Memory Hardware Error	An error occurred in non-volatile memory.	<ul style="list-style-type: none"> Non-volatile memory failure 			○			W565
05120000 hex	A/D Conversion Error	AD conversion was not performed by the AD converter.	<ul style="list-style-type: none"> EXC+ terminal and EXC- terminal are short-circuited. Noise A/D converter failure 			○			W565
10410000 hex	Control Parameter Error in Master	An error occurred in the control parameters that are saved in the master.	<p>For the NX bus of CPU Units</p> <ul style="list-style-type: none"> The power supply to the CPU Unit was turned OFF while writing the Unit operation settings was in progress. Or there is an error in the area of the non-volatile memory in the CPU Unit in which the Unit operation settings for the relevant NX Unit are saved. <p>For Communications Coupler Units</p> <ul style="list-style-type: none"> The power supply to the Communications Coupler Unit was turned OFF while writing the Unit operation settings was in progress. Or there is an error in the area of the non-volatile memory in the Communications Coupler Unit in which the Unit operation settings for the relevant NX Unit are saved. 			○			W565
10440000 hex	Unit Calibration Value Error	There is an error in the area in which the Unit calibration values are saved.	<ul style="list-style-type: none"> There is an error in the area of the non-volatile memory in which the Unit calibration values are saved. 			○			W565
10450000 hex	Actual Load Calibration Value Error	There is an error in the area in which the actual load calibration values are saved.	<ul style="list-style-type: none"> There is an error in the area of the non-volatile memory in which the actual load calibration values are saved. 			○			W565

Event code	Event name	Meaning	Assumed cause	Level					Reference
				M a j	P r t	M i n	O b s	I n f o	
40200000 hex	NX Unit Processing Error	A fatal error occurred in an NX Unit.	<ul style="list-style-type: none"> An error occurred in the software. 			○			W565
65130000 hex	Sensor Disconnected Error	A disconnection with the load cell was detected.	<ul style="list-style-type: none"> Wiring with the load cell is not connected. Wiring with the load cell is broken. The input signal exceeds the input conversion range. Load cell failure. 			○			W565
80200000 hex	NX Unit I/O Communications Error	An I/O communications error occurred in an NX Unit.	<p>For the NX bus of CPU Units</p> <ul style="list-style-type: none"> An error that prevents normal NX bus communications occurred in a CPU Unit. An NX Unit is not mounted properly. The power cable for the Unit power supply is disconnected, or the wiring from the Unit power supply to the NX Units is incorrect. The power cable for the Unit power supply is broken. The voltage of the Unit power supply is outside the specified range, or the capacity of the Unit power supply is insufficient. There is a hardware error in an NX Unit. <p>For Communications Coupler Units</p> <ul style="list-style-type: none"> An error that prevents normal NX bus communications occurred in a Communications Coupler Unit. The NX Unit is not mounted properly. The power cable for the Unit power supply is disconnected. Or, the wiring from the Unit power supply to the NX Units is incorrect. The power cable for the Unit power supply is broken. The voltage of the Unit power supply is outside the specified range. Or, the capacity of the Unit power supply is insufficient. There is a hardware error in the NX Unit. 			○			W565



Event code	Event name	Meaning	Assumed cause	Level					Reference
				M a j	P r t	M i n	O b s	I n f o	
80210000 hex	NX Unit Output Synchronization Error	An output synchronization error occurred in the NX Unit.	<p>For the NX bus of CPU Units</p> <ul style="list-style-type: none"> I/O refreshing on the NX bus is not performed normally due to an error in the CPU Unit. <p>For Communications Coupler Units</p> <ul style="list-style-type: none"> The communications cable connected to the Communications Coupler Unit is broken or the connection is faulty. The communications cable is affected by noise. 			○			W565
80240000 hex	NX Unit Clock Not Synchronized Error	A time information error occurred in an NX Unit.	<p>For the NX bus of CPU Units</p> <ul style="list-style-type: none"> There is a hardware error in an NX Unit. There is a hardware error in a CPU Unit. <p>For Communications Coupler Units</p> <ul style="list-style-type: none"> There is a hardware error in an NX Unit. There is a hardware error in an EtherCAT Coupler Unit. 			○			W565
65140000 hex	Over Range	The input signal from the load cell exceeded the upper limit of the input conversion range.	<ul style="list-style-type: none"> Wiring with the load cell is not connected. Wiring with the load cell is broken. EXC+ terminal and EXC- terminal are short-circuited. Load cell failure. A load cell with which the rated output exceeds the input range of the Load Cell Input Unit is used. A load that exceeds the rated capacity is applied to the load cell. Noise 			⊙	○		W565

Event code	Event name	Meaning	Assumed cause	Level					Reference
				M a j	P r t	M i n	O b s	I n f o	
65150000 hex	Under Range	The input signal from the load cell went below the lower limit of the input conversion range.	<ul style="list-style-type: none"> Wiring with the load cell is not connected. Wiring with the load cell is broken. EXC+ terminal and EXC- terminal are short-circuited. Load cell failure. A load cell with which the rated output exceeds the input range of the Load Cell Input Unit is used. A load that exceeds the rated capacity is applied to the load cell. Noise 			○	○		W565
80220000 hex	NX Message Communications Error	An error was detected in message communications and the message frame was discarded.	<p>For the NX bus of CPU Units</p> <ul style="list-style-type: none"> The message communications load is high. <p>For Communications Coupler Units</p> <ul style="list-style-type: none"> The message communications load is high. The communications cable is disconnected or broken. Message communications were cutoff in communications. 				○		W565
90400000 hex	Event Log Cleared	The event log was cleared.	<ul style="list-style-type: none"> The event log was cleared by the user. 					○	W565



NX-series IO-Link Master Units

The section provides a table of errors (events) that can occur in the following Unit.

NX-ILM□□□

The manual name is given below for the catalog numbers given in the Reference column of the event table.

Cat. No.	Manual name
W570	IO-Link System User's Manual

Event code	Event name	Meaning	Assumed cause	Level					Reference
				M a j	P r t	M i n	O b s	I n f o	
00200000 hex	Non-volatile Memory Hardware Error	An error occurred in non-volatile memory.	<ul style="list-style-type: none"> Non-volatile memory failure 			○			W570
10410000 hex	Control Parameter Error in Master	An error occurred in the control parameters that are saved in the master.	<p>For the NX bus of CPU Units</p> <ul style="list-style-type: none"> The power supply to the CPU Unit was turned OFF while writing the Unit operation settings was in progress. Or there is an error in the area of the non-volatile memory in the CPU Unit in which the Unit operation settings for the relevant NX Unit are saved. <p>For Communications Coupler Units</p> <ul style="list-style-type: none"> The power supply to the Communications Coupler Unit was turned OFF while writing the Unit operation settings was in progress. Or there is an error in the area of the non-volatile memory in the Communications Coupler Unit in which the Unit operation settings for the relevant NX Unit are saved. 			○			W570
40200000 hex	NX Unit Processing Error	A fatal error occurred in an NX Unit.	An error occurred in the software.			○			W570

Event code	Event name	Meaning	Assumed cause	Level					Reference
				M a j	P r t	M i n	O b s	I n f o	
80200000 hex	NX Unit I/O Communications Error	An I/O communications error occurred in an NX Unit.	<p>For the NX bus of CPU Units</p> <ul style="list-style-type: none"> An error that prevents normal NX bus communications occurred in a CPU Unit. An NX Unit is not mounted properly. The power cable for the Unit power supply is disconnected, or the wiring from the Unit power supply to the NX Units is incorrect. The power cable for the Unit power supply is broken. The voltage of the Unit power supply is outside the specified range, or the capacity of the Unit power supply is insufficient. There is a hardware error in an NX Unit. <p>For Communications Coupler Units</p> <ul style="list-style-type: none"> An error that prevents normal NX bus communications occurred in a Communications Coupler Unit. The NX Unit is not mounted properly. The power cable for the Unit power supply is disconnected. Or, the wiring from the Unit power supply to the NX Units is incorrect. The power cable for the Unit power supply is broken. The voltage of the Unit power supply is outside the specified range. Or, the capacity of the Unit power supply is insufficient. There is a hardware error in the NX Unit. 						W570

Event code	Event name	Meaning	Assumed cause	Level					Reference
				M a j	P r t	M i n	O b s	I n f o	
80240000 hex	NX Unit Clock Not Synchronized Error	A time information error occurred in an NX Unit.	For the NX bus of CPU Units <ul style="list-style-type: none"> • There is a hardware error in an NX Unit. • There is a hardware error in a CPU Unit. For Communications Coupler Units <ul style="list-style-type: none"> • There is a hardware error in an NX Unit. • There is a hardware error in an EtherCAT Coupler Unit. 			○			W570
848F0000 hex	Device Configuration Verification Error	The connected device is different from the IO-Link device registered for a port of the IO-Link Master.	<ul style="list-style-type: none"> • The connected device is different from the IO-Link device registered for a port of the IO-Link Master. 			○			W570
84970000 hex	I/O Cable Short-circuit	There is a short-circuit in the cable that connects the IO-Link master and device.	<ul style="list-style-type: none"> • There is a short-circuit in the I/O cable. • An IO-Link device has failed. 			○			W570
849A0000 hex	IO-Link Communications Module Processing Error	A hardware failure occurred in the IO-Link Communications Module.	<ul style="list-style-type: none"> • A hardware failure occurred. 			○			W570
80220000 hex	NX Message Communications Error	An error was detected in message communications and the message frame was discarded.	For the NX bus of CPU Units <ul style="list-style-type: none"> • The message communications load is high. For Communications Coupler Units <ul style="list-style-type: none"> • The message communications load is high. • The communications cable is disconnected or broken. • Message communications were cutoff in communications. 			○			W570
848C0000 hex	Error-level Device Event	An error-level event occurred in the IO-Link device.	Use CX-Configurator FDT to confirm the event code of the IO-Link device.			○			W570
848D0000 hex	IO-Link Communications Error	An error occurred in IO-Link communications with a device.	<ul style="list-style-type: none"> • The I/O cable is broken. • IO-Link device failure. • The communications were affected by noise. 			○			W570
84990000 hex	Warning-level Device Event Flag	A warning-level event occurred in the IO-Link device.	Use CX-Configurator FDT to confirm the event code of the IO-Link device.			○			W570
84950000 hex	IO-Link Device Configuration Information Created	IO-Link device configuration information was created.	IO-Link device configuration information was created.				○		W570

Event code	Event name	Meaning	Assumed cause	Level					Reference
				M a j	P r t	M i n	O b s	I n f o	
84980000 hex	I/O Power Supply ON Detected	The I/O power supply ON was detected in several times.	The I/O power supply ON was detected in several times.					○	W570
90400000 hex	Event Log Cleared	The event log was cleared.	The event log was cleared by the user.					○	W570

A

NX-series Temperature Control Units

The section provides a table of the errors (events) that can occur in the following Unit.
 NX-TC□□□□

The manual names are given below for the catalog numbers given in the Reference column of the event table.

Cat. No.	Manual name
H228	NX-series Temperature Control Units User's Manual

Event code	Event name	Meaning	Assumed cause	Level					Reference
				M a j	P r t	M i n	O b s	I n f o	
00200000 hex	Non-volatile Memory Hardware Error	An error occurred in non-volatile memory.	<ul style="list-style-type: none"> Non-volatile memory failure 				○		H228
05100000 hex	A/D Converter Error	An error occurred in the A/D converter.	<ul style="list-style-type: none"> Noise A/D converter failure 				○		H228
05110000 hex	Cold Junction Sensor Error	The temperature cannot be converted because the cold junction sensor is disconnected.	<ul style="list-style-type: none"> There is a faulty connection to the cold junction sensor. The cold junction sensor failed. 				○	◐	H228
10410000 hex	Control Parameter Error in Master	An error occurred in the control parameters that are saved in the master.	<p>For the NX bus of CPU Units</p> <ul style="list-style-type: none"> The power supply to the CPU Unit was turned OFF while writing the Unit operation settings was in progress. Or there is an error in the area of the non-volatile memory in the CPU Unit in which the Unit operation settings for the relevant NX Unit are saved. <p>For Communications Coupler Units</p> <ul style="list-style-type: none"> The power supply to the Communications Coupler Unit was turned OFF while writing the Unit operation settings was in progress. Or there is an error in the area of the non-volatile memory in the Communications Coupler Unit in which the Unit operation settings for the relevant NX Unit are saved. 				○		H228



Event code	Event name	Meaning	Assumed cause	Level					Reference
				M a j	P r t	M i n	O b s	I n f o	
14C10000 hex	Invalid Tuning Parameters Saved in the Unit	Failed to write the tuning result to the non-volatile memory, the tuning parameters saved in the Unit became invalid.	<ul style="list-style-type: none"> Power was turned OFF during tuning. 			○			H228
40200000 hex	NX Unit Processing Error	A fatal error occurred in an NX Unit.	<ul style="list-style-type: none"> An error occurred in the software. 			○			H228
65100000 hex	Sensor Disconnected Error	A disconnected temperature sensor was detected.	<ul style="list-style-type: none"> The temperature sensor is damaged or the wires are broken. An unused channel is not disabled. The wiring to the temperature sensor is incorrect. The input type is not set correctly when this error occurs in the Temperature Control Unit. The measured value exceeds the input indication range when this error occurs in the Temperature Control Unit. The PV Input Shift or the PV Input Slope Coefficient is not set correctly when this error occurs in the Temperature Control Unit. 			○	◉		H228
652C0000 hex	Heater Burnout Detected	A heater burnout was detected.	<ul style="list-style-type: none"> A heater was burned out or damaged. The setting of the Heater Burnout Detection Current is too high. A CT input that is not used is allocated to a control output in the CT Allocation setting when this error occurs in the Heater Burnout Detection Unit. An unused channel is not disabled when this error occurs in the Temperature Control Unit. 			○	◉		H228

Event code	Event name	Meaning	Assumed cause	Level					Reference
				M a j	P r t	M i n	O b s	I n f o	
652D0000 hex	SSR Failure Detected	An SSR failure was detected.	<ul style="list-style-type: none"> The SSR was short-circuited or damaged. The setting of the SSR Failure Detection Current is too small. A CT input that is not used is allocated to a control output in the CT Allocation setting when this error occurs in the Heater Burnout Detection Unit. An unused channel is not disabled when this error occurs in the Temperature Control Unit. 			○	⊙		H228
652E0000 hex	Alarm Detected	The alarm set for the alarm type was detected.	<p>An alarm was detected, which was set to output in the following cases according to the alarm type:</p> <ul style="list-style-type: none"> - if a measured value deviates for the amount specified by the alarm upper limit and/or alarm lower limit, or - if a measured value is greater or smaller than the specified alarm value. <p>The following values that are set according to the alarm type do not conform to the alarm that is to be detected.</p> <ul style="list-style-type: none"> Alarm value Alarm upper limit and alarm lower limit 			○	⊙		H228

Event code	Event name	Meaning	Assumed cause	Level					Reference
				M a j	P r t	M i n	O b s	I n f o	
80200000 hex	NX Unit I/O Communications Error	An I/O communications error occurred in an NX Unit.	<p>For the NX bus of CPU Units</p> <ul style="list-style-type: none"> An error that prevents normal NX bus communications occurred in a CPU Unit. An NX Unit is not mounted properly. The power cable for the Unit power supply is disconnected, or the wiring from the Unit power supply to the NX Units is incorrect. The power cable for the Unit power supply is broken. The voltage of the Unit power supply is outside the specified range, or the capacity of the Unit power supply is insufficient. There is a hardware error in an NX Unit. <p>For Communications Coupler Units</p> <ul style="list-style-type: none"> An error that prevents normal NX bus communications occurred in a Communications Coupler Unit. The NX Unit is not mounted properly. The power cable for the Unit power supply is disconnected. Or, the wiring from the Unit power supply to the NX Units is incorrect. The power cable for the Unit power supply is broken. The voltage of the Unit power supply is outside the specified range. Or, the capacity of the Unit power supply is insufficient. There is a hardware error in an NX Unit. 						H228

Event code	Event name	Meaning	Assumed cause	Level					Reference
				M a j	P r t	M i n	O b s	I n f o	
80240000 hex	NX Unit Clock Not Synchronized Error	A time information error occurred in an NX Unit.	For the NX bus of CPU Units <ul style="list-style-type: none"> • There is a hardware error in an NX Unit. • There is a hardware error in a CPU Unit. For Communications Coupler Units <ul style="list-style-type: none"> • There is a hardware error in an NX Unit. • There is a hardware error in an EtherCAT Coupler Unit. 			○			H228
80220000 hex	NX Message Communications Error	An error was detected in message communications and the message frame was discarded.	For the NX bus of CPU Units <ul style="list-style-type: none"> • The message communications load is high. For Communications Coupler Units <ul style="list-style-type: none"> • The message communications load is high. • The communications cable is disconnected or broken. • Message communications were cutoff in communications. 				○		H228
90400000 hex	Event Log Cleared	The event log was cleared.	The event log was cleared by the user.					○	H228
94D00000 hex	Tuning Parameter Updated	The parameters were updated by tuning.	Tuning of one of the following functions by the user operation was completed normally and the tuning parameters were updated. <ul style="list-style-type: none"> • AT • Automatic filter adjustment • PID update by Adaptive control with the Notification • D-AT 					○	H228
94D10000 hex	Related Parameters Initialized	Related parameters were initialized by parameter changes.	<ul style="list-style-type: none"> • The model parameters of adaptive control were initialized because either the input type parameter or the temperature unit parameter had been changed. 					○	H228
94F00000 hex	Tuning Parameter Automatically Updated	The parameters were automatically updated by tuning.	Tuning by automatic execution of the following functions was completed normally, and the tuning parameters were updated. <ul style="list-style-type: none"> • Water-cooling output adjustment • Adaptive control with the Automatic update 					○	H228

NX-series EtherNet/IP Units

The section provides a table of the errors (events) that can occur in the following Unit.
NX-EIP201

The manual names are given below for the catalog numbers given in the Reference column of the event table.

Cat. No.	Manual name
W627	NX-series EtherNet/IP Unit User's Manual

● Ethernet Function

Event code	Event name	Meaning	Assumed cause	Level					Reference
				M a j	P r t	M i n	O b s	I n f o	
04310000 hex	Communications Controller Error	A hardware error was detected in the Communications Controller of the EtherNet/IP port.	<ul style="list-style-type: none"> Hardware failure of Communications Controller 				○		W627
14310000 hex	MAC Address Error	MAC address in non-volatile memory could not be read correctly.	<ul style="list-style-type: none"> Non-volatile memory failure 				○		W627
14340000 hex	Ethernet Processing Error	A fatal error was detected in the Ethernet Function Module.	<ul style="list-style-type: none"> Hardware failure 				○		W627
36010000 hex	Basic Ethernet Setting Error	An Ethernet setting error was detected.	<ul style="list-style-type: none"> Parameter error Power interruption while downloading EtherNet/IP port settings Memory error 				○		W627
36020000 hex	IP Address Setting Error	An IP address setting error was detected.	<ul style="list-style-type: none"> Parameter error Power interruption while downloading EtherNet/IP port settings The IP address obtained from the BOOTP server is invalid. Memory error 				○		W627
36030000 hex	IP Rout Table Setting Error	An error was detected in the IP routing function settings.	<ul style="list-style-type: none"> Parameter error Power interruption while downloading EtherNet/IP port settings Memory error 				○		W627
36060000 hex	SNMP Setting Error	A setting error in SNMP agent/trap was detected.	<ul style="list-style-type: none"> Parameter error Power interruption while downloading SNMP agent/trap settings Memory error 				○		W627

A

Event code	Event name	Meaning	Assumed cause	Level					Reference
				M a j	P r t	M i n	O b s	I n f o	
36080000 hex	DNS Setting Error	Errors were detected in DNS setting and Hosts setting.	<ul style="list-style-type: none"> Parameter error Power interruption while downloading EtherNet/IP port settings Memory error 			○			W627
85D00000 hex	IP Address Duplication Error	The IP address is duplicated.	<ul style="list-style-type: none"> The IP address of the EtherNet/IP port is duplicated with the IP address of another node. 			○			W627
85D10000 hex	BOOTP Server Connection Error	Connection to the BOOTP server failed.	<ul style="list-style-type: none"> The server is misconfigured. The server went down. Abnormalities occurred in the communication path. 			○			W627
85D40000 hex	Packet Discarded Due to Full Reception Buffer	A packet drop occurred.	<ul style="list-style-type: none"> Network congestion occurred. 				○		W627
85D50000 hex	Link OFF Detected	An Ethernet link OFF was detected.	<ul style="list-style-type: none"> An Ethernet cable is broken, disconnected, or loose. The Ethernet switch's power supply is turned OFF. Communications speed mismatched. Noise The identity object was reset. Settings for Ethernet were downloaded from the Network Configurator or Sysmac Studio, or the Clear All Memory operation was performed. The built-in EtherNet/IP port was restarted. 			○	○		W627
96440000 hex	Link Detected	Establishment of an Ethernet link was detected.	<ul style="list-style-type: none"> Establishment of an Ethernet link was detected. 					○	W627
96470000 hex	IP Address Fixed	The correct IP address has been determined and Ethernet communications can start.	<ul style="list-style-type: none"> The correct IP address has been determined and Ethernet communications can start. 					○	W627
96480000 hex	BOOTP Client Started	The BOOTP client started requesting an IP address.	<ul style="list-style-type: none"> The BOOTP client started requesting an IP address. 					○	W627
964B0000 hex	SNMP Started	The SNMP agent started normally.	<ul style="list-style-type: none"> The SNMP agent started normally. 					○	W627
96500000 hex	IP Address Changed	The IP address was changed.	<ul style="list-style-type: none"> The IP address was changed. 					○	W627
96510000 hex	SNMP Settings Changed	SNMP Settings were changed.	<ul style="list-style-type: none"> SNMP Settings were changed. 					○	W627

Event code	Event name	Meaning	Assumed cause	Level					Reference
				M a j	P r t	M i n	O b s	I n f o	
96520000 hex	Subnet Mask Changed	The subnet mask was changed.	<ul style="list-style-type: none"> The subnet mask was changed. 					○	W627

● **EtherNet/IP Function**

Event code	Event name	Meaning	Assumed cause	Level					Reference
				M a j	P r t	M i n	O b s	I n f o	
14210000 hex	Identity Error	The CIP identity information in non-volatile memory was not read correctly.	<ul style="list-style-type: none"> Non-volatile memory failure 			○			W627
34200000 hex	Tag Data Link Setting Error	An error was detected in the communications settings for tag data links.	<ul style="list-style-type: none"> Power was interrupted when a download was in progress for the tag data link settings. Memory error 			○			W627
34270000 hex	Tag Name Resolution Error	Resolution of a tag used in a tag data link failed.	<ul style="list-style-type: none"> The size of the network variable is different from the tag settings. The I/O direction that is set in the tag data link settings does not agree with the I/O direction of the variable in the Controller. There is no network variable in the Controller that corresponds to the tag setting. A variable in the Controller that is set for a tag data link has the Network Publish attribute set to Input but also has the Constant attribute. 			○			W627



Event code	Event name	Meaning	Assumed cause	Level					Reference
				M a j	P r t	M i n	O b s	I n f o	
84070000 hex	Tag Data Link Connection Failed	Establishing a tag data link connection failed.	<ul style="list-style-type: none"> The tag data link connection information is not the same for the originator and target. Insufficient connections CIP message communications at the target node are stopped. Setting to use tag data link communications was made to the NX-series EtherNet/IP Unit that is included in the CIP Safety connection settings (for NX-series EtherNet/IP Units). The NX-series EtherNet/IP Unit with tag data link communications was added to the CIP Safety connection settings (for NX-series EtherNet/IP Units). 			○			W627
84080000 hex	Tag Data Link Timeout	A timeout occurred in a tag data link.	<ul style="list-style-type: none"> The power supply to the target node is OFF. Communications at the target node are stopped. The Ethernet cable connector for EtherNet/IP is disconnected. The Ethernet cable for EtherNet/IP is broken. The link to the EtherNet/IP port is OFF. CIP message communications at the target node are stopped. When the Packet Filter function is enabled in the EtherNet/IP Port Settings, packets from the target are not allowed. CIP communications are not allowed by the firewall function or Packet Filter function on the target node or the devices on the communication path. The packet loss occurred on the path due to the network communications load. Noise 			○			W627

Event code	Event name	Meaning	Assumed cause	Level					Reference
				M a j	P r t	M i n	O b s	I n f o	
84090000 hex	Tag Data Link Connection Timeout	A timeout occurred while trying to establish a tag data link connection.	<ul style="list-style-type: none"> The power supply to the target node is OFF. Communications at the target node are stopped. CIP message communications are stopped at the target node or the EtherNet/IP port. The Ethernet cable connector for EtherNet/IP is disconnected. The Ethernet cable for EtherNet/IP is broken. CIP communications are not allowed by the firewall function or Packet Filter function on the target node or the devices on the communication path. Abnormalities occurred in the communication path. 				○	○	W627
840C0000 hex	Allowed Communications Bandwidth per Unit Exceeded	The total bandwidth for the connections that are set or established for all of the EtherNet/IP ports exceeded the allowed communications bandwidth of tag data links and CIP Safety communications per Unit.	<ul style="list-style-type: none"> An attempt was made to establish a connection of communications bandwidth (PPS), which is the sum of the packet transmission rates of the tag data links and CIP Safety communications used for all EtherNet/IP ports, and it exceeded the allowable communications bandwidth of the Unit. 				○		W627
840E0000 hex	Number of Tag Sets for Tag Data Links Exceeded	The total number of tag sets for tag data links for all EtherNet/IP ports exceeds the upper limit.	<ul style="list-style-type: none"> The total number for all ports of tag sets for tag data links that are set for each EtherNet/IP port exceeded the total number the product allows. 				○		W627
342C0000 hex	Unit Configuration Error, Combined Use of CIP Safety and Tag Data Link	Tag data link communications and CIP Safety communications cannot be used together in one NX-series EtherNet/IP Unit.	<ul style="list-style-type: none"> Setting to use tag data link communications was made to the NX-series EtherNet/IP Unit that is included in the CIP Safety connection settings. The NX-series EtherNet/IP Unit with tag data link communications was added to the CIP Safety connection settings. 				○		W627

Event code	Event name	Meaning	Assumed cause	Level					Reference
				M a j	P r t	M i n	O b s	I n f o	
54E00000 hex	Access De- tected Out- side Range of Variable	Accessing a value that is out of range was detected for a tag variable that is used in a tag data link.	<ul style="list-style-type: none"> An out-of-range value was written by an EtherNet/IP tag data link for a variable with a specified range. A value that does not specify an enumerator was written by an EtherNet/IP tag data link for an enumeration variable. 				○		W627
94010000 hex	Tag Data Link Down- load Started	Changing the tag da- ta link settings start- ed.	<ul style="list-style-type: none"> Changing the tag data link settings started. 					○	W627
94020000 hex	Tag Data Link Down- load Finish- ed	Changing the tag da- ta link settings finish- ed.	<ul style="list-style-type: none"> Changing the tag data link settings finished. 					○	W627
94030000 hex	Tag Data Link Stop- ped	Tag data links were stopped by the Net- work Configurator, Sysmac Studio, or manipulation of a sys- tem-defined variable. Or, the data link table was downloaded from Network Configurator or Sysmac Studio.	<ul style="list-style-type: none"> Tag data links were stopped by the Network Configurator, Sysmac Studio, or manipulation of a system-defined variable. 					○	W627
94040000 hex	Tag Data Link Started	Tag data links were started by the Net- work Configurator, Sysmac Studio, or manipulation of a sys- tem-defined variable. Or, the data link table was downloaded from Network Configurator or Sysmac Studio.	<ul style="list-style-type: none"> Tag data links were started by the Network Configurator, Sysmac Studio, or manipulation of a system-defined variable. 					○	W627
94070000 hex	Tag Data Link All Run	Tag data link connec- tions to all nodes have been normally established.	<ul style="list-style-type: none"> Tag data link connections to all target nodes have been normally established. 					○	W627
96450000 hex	Restarting Ethernet Port	The EtherNet/IP port was restarted.	<ul style="list-style-type: none"> The EtherNet/IP port was re-started. 					○	W627

NX-series High-speed Counter Units

The section provides a table of the errors (events) that can occur in the following Units.

NX-CT□□□□

The manual names are given below for the catalog numbers given in the Reference column of the event table.

Cat. No.	Manual name
W647	NX-series High-speed Counter Units User's Manual

Event code	Event name	Meaning	Assumed cause	Level					Reference
				M a j	P r t	M i n	O b s	I n f o	
00200000 hex	Non-volatile Memory Hardware Error	An error occurred in non-volatile memory.	<ul style="list-style-type: none"> Non-volatile memory failure 			○			W647
10410000 hex	Control Parameter Error in Master	An error occurred in the control parameters that are saved in the master.	<p>For the NX bus of CPU Units</p> <ul style="list-style-type: none"> The power supply to the CPU Unit was turned OFF while writing the Unit operation settings was in progress. Or there is an error in the area of the non-volatile memory in the CPU Unit in which the Unit operation settings for the relevant NX Unit are saved. <p>For Communications Coupler Units</p> <ul style="list-style-type: none"> The power supply to the Communications Coupler Unit was turned OFF while writing the Unit operation settings was in progress. Or there is an error in the area of the non-volatile memory in the Communications Coupler Unit in which the Unit operation settings for the relevant NX Unit are saved. 			○			W647
39200000 hex	Counter Log Data I/O Allocation Setting Error	The I/O allocation setting of Ch1 Counter Log Data is incorrect.	<p>The I/O allocation setting of Ch1 Counter Log Data is incorrect. Not allocated in numerical order from Ch1 Counter Log Data1. Example: Ch1 Counter Log Data1 and Ch1 Counter Log Data3 are allocated, but Ch1 Counter Log Data2 is not.</p>			○			W647

A

Event code	Event name	Meaning	Assumed cause	Level					Reference
				M a j	P r t	M i n	O b s	I n f o	
39210000 hex	Comparison Initial Data Setting Error	Comparison initial data setting is out of range.	<p>Comparison initial data setting is out of range.</p> <p>For Target Comparison</p> <ul style="list-style-type: none"> Target Comparison Data Target Value Default Value is outside the range of minimum to maximum counter values. <p>For Range Comparison</p> <ul style="list-style-type: none"> Range Comparison Data Lower Limit Default Value and Range Comparison Data Upper Limit Default Value are outside the range of minimum to maximum counter values. In linear mode, the lower limit is set larger than the upper limit. 			○			W647
40200000 hex	NX Unit Processing Error	A fatal error occurred in an NX Unit.	<ul style="list-style-type: none"> An error occurred in the software. 			○			W647



Event code	Event name	Meaning	Assumed cause	Level					Reference
				M a j	P r t	M i n	O b s	I n f o	
80200000 hex	NX Unit I/O Communications Error	An I/O communications error occurred in an NX Unit.	<p>For the NX bus of CPU Units</p> <ul style="list-style-type: none"> An error that prevents normal NX bus communications occurred in a CPU Unit. An NX Unit is not mounted properly. The power cable for the Unit power supply is disconnected, or the wiring from the Unit power supply to the NX Units is incorrect. The power cable for the Unit power supply is broken. The voltage of the Unit power supply is outside the specified range, or the capacity of the Unit power supply is insufficient. There is a hardware error in an NX Unit. <p>For Communications Coupler Units</p> <ul style="list-style-type: none"> An error that prevents normal NX bus communications occurred in a Communications Coupler Unit. The NX Unit is not mounted properly. The power cable for the Unit power supply is disconnected. Or, the wiring from the Unit power supply to the NX Units is incorrect. The power cable for the Unit power supply is broken. The voltage of the Unit power supply is outside the specified range. Or, the capacity of the Unit power supply is insufficient. There is a hardware error in an NX Unit. 						W647

Event code	Event name	Meaning	Assumed cause	Level					Reference
				M a j	P r t	M i n	O b s	I n f o	
80210000 hex	NX Unit Output Synchronization Error	An output synchronization error occurred in the NX Unit.	<p>For the NX bus of CPU Units</p> <ul style="list-style-type: none"> I/O refreshing on the NX bus is not performed normally due to an error in the CPU Unit. <p>For Communications Coupler Units</p> <ul style="list-style-type: none"> The communications cable connected to the Communications Coupler Unit is broken or the connection is faulty. The communications cable is affected by noise. 			○			W647
80240000 hex	NX Unit Clock Not Synchronized Error	A time information error occurred in an NX Unit.	<p>For the NX bus of CPU Units</p> <ul style="list-style-type: none"> There is a hardware error in an NX Unit. There is a hardware error in a CPU Unit. <p>For Communications Coupler Units</p> <ul style="list-style-type: none"> There is a hardware error in an NX Unit. There is a hardware error in an EtherCAT Coupler Unit. 			○			W647
80220000 hex	NX Message Communications Error	An error was detected in message communications and the message frame was discarded.	<p>For the NX bus of CPU Units</p> <ul style="list-style-type: none"> The message communications load is high. <p>For Communications Coupler Units</p> <ul style="list-style-type: none"> The message communications load is high. The communications cable is disconnected or broken. Message communications were cutoff in communications. 				○		W647
90400000 hex	Event Log Cleared	The event log was cleared.	<ul style="list-style-type: none"> The event log was cleared by the user. 					○	W647

A-2-2 Errors in EtherCAT Slaves

This section provides tables of the errors (events) for which the following OMRON EtherCAT slaves provide notification to the NJ/NX-series CPU Unit.

- GX-series EtherCAT Slave Units
- Servo 1S (1S-series AC Servo Drives with Built-in EtherCAT Communications)
R88M-1□, R88D-1SN□-ECT and R88D-1SAN□-ECT
- Servo G5 (G5-series AC Servo Drives with Built-in EtherCAT Communications)
and G5 Linear (G5-series Linear Motors/Drives with Built-in EtherCAT Communications Linear Motor Type)
- MX2/RX-series Inverters with EtherCAT Communications Units
- FH-series Vision Systems
- EtherCAT FQ-M-series Specialized Vision Sensors for Positioning
- E3X-series Fiber Sensors with EtherCAT Communications Unit for Digital Sensors
- E3NW-ECT EtherCAT Digital Sensor Communications Unit
- ZW-CE1□T Confocal Fiber Type Displacement Sensor

GX-series EtherCAT Slave Units

The manual names are given below for the catalog numbers given in the Reference column of the event table.

Cat. No.	Manual name
W488	GX-series EtherCAT Slave Units User's Manual
W570	IO-Link System User's Manual

● Block I/O

Event code	Event name	Meaning	Assumed cause	Level					Reference
				M a j	P r t	M i n	O b s	I n f o	
04A00000 hex	Expansion Unit Hardware Error	An Expansion Unit was disconnected during operation or a signal between the Slave Unit and Expansion Unit was broken.	<ul style="list-style-type: none"> • The Expansion Unit is disconnected. • The Expansion Unit is faulty. 			○			W488
04A20000 hex	Slave Hardware Error	A hardware error occurred in the Slave Unit.	<ul style="list-style-type: none"> • The Slave Unit is faulty. 			○			W488
14A00000 hex	Non-volatile Memory Checksum Error	An error occurred in the control parameters.	<ul style="list-style-type: none"> • Noise 			○			W488 W640
24610000 hex	Switch Setting Error	The setting switch is set out of range.	<ul style="list-style-type: none"> • The analog range that is set on the switch is outside the setting range. 			○			W488

Event code	Event name	Meaning	Assumed cause	Level					Reference
				M a j	P r t	M i n	O b s	I n f o	
64CC0000 hex	I/O Disconnection Detected	An I/O signal line is disconnected.	<ul style="list-style-type: none"> I/O signal wiring is disconnected or has a faulty connection. An I/O signal line is disconnected. 			○			W488
84A00000 hex	Slave Unit Verification Error	A verification error occurred for the SII.	<ul style="list-style-type: none"> An error occurred in the control board. 			○			W488 W640
04A10000 hex	Non-volatile Memory Hardware Error	An error occurred in non-volatile memory.	<ul style="list-style-type: none"> Non-volatile memory failure Noise 				○		W488 W640

● IO-Link Master Units

Event code	Event name	Meaning	Assumed cause	Level					Reference
				M a j	P r t	M i n	O b s	I n f o	
04A10000 hex	Non-volatile Memory Hardware Error	An error occurred in non-volatile memory.	<ul style="list-style-type: none"> Non-volatile memory failure Noise 			○			W570 W640
04A20000 hex	Slave Hardware Error	A hardware error occurred in the Slave Unit.	<ul style="list-style-type: none"> The Slave Unit is faulty. 			○			W570
14A00000 hex	Non-volatile Memory Checksum Error	An error occurred in the control parameters.	<ul style="list-style-type: none"> Noise 			○			W570 W640
847C0000 hex	Device Configuration Verification Error	The connected device is different from the IO-Link device registered for a port of the IO-Link Master.	<ul style="list-style-type: none"> The connected device is different from the IO-Link device registered for a port of the IO-Link Master. 			○			W570 W640
84840000 hex	I/O Cable Short-circuit	There is a short-circuit in the cable that connects the IO-Link master and device.	<ul style="list-style-type: none"> There is a short-circuit in the I/O cable. An IO-Link device has failed. 			○			W570 W640
84870000 hex	IO-Link Communications Module Processing Error	A hardware failure occurred in the IO-Link Communications Module.	<ul style="list-style-type: none"> A hardware failure occurred. 			○			W570
84A00000 hex	Slave Unit Verification Error	An error occurred in Slave Unit verification.	<ul style="list-style-type: none"> An error occurred in the control board. 			○			W570 W640
84790000 hex	Error-level Device Event	An error-level event occurred in the IO-Link device.	<ul style="list-style-type: none"> Use CX-Configurator FDT to confirm the event code of the IO-Link device. 				○		W570 W640
847A0000 hex	IO-Link Communications Error	An error occurred in IO-Link communications with a device.	<ul style="list-style-type: none"> The I/O cable is broken. Or, the IO-Link device is disconnected from the port. The communications were affected by noise. IO-Link device failure. 				○		W570 W640
84860000 hex	Warning-level Device Event Flag	A warning-level event occurred in the IO-Link device.	Use CX-Configurator FDT to confirm the event code of the IO-Link device.				○		W570 W640
84820000 hex	IO-Link Device Configuration Information Created	IO-Link device configuration information was created.	<ul style="list-style-type: none"> IO-Link device configuration information was created. 					○	W570 W640
84850000 hex	I/O Power Supply ON Detected	The I/O power supply ON was detected in several times.	<ul style="list-style-type: none"> The I/O power supply ON was detected in several times. 					○	W570

A

Servo 1S (1S-series AC Servo Drives with Built-in EtherCAT Communications) R88M-1□, R88D-1SN□-ECT, and R88D-1SAN□-ECT

The section provides a table of the errors (events) that can occur in R88M-1□ (AC Servomotors), R88D-1SN□-ECT (AC Servo Drives) and R88D-1SAN□-ECT (AC Servo Drives).

The manual name is given below for the catalog numbers given in the Reference column of the event table.

Cat. No.	Manual name
I586	AC Servomotors/Servo Drives 1S-series with Built-in EtherCAT Communications User's Manual
I621	AC Servomotors/Servo Drives 1S-series with Built-in EtherCAT Communications and Safety Functionality User's Manual

Event code	Event name	Meaning	Assumed cause	Level					Reference
				M a j	P r t	M i n	O b s	I n f o	
04B30000 hex	Regeneration Circuit Error Detected during Power ON	An error of the Regeneration Circuit was detected at power ON.	<ul style="list-style-type: none"> Power supply voltage is insufficient at power ON, or rising slowly. Power supply voltage fluctuated at power ON. L1, L2, and L3 terminals are not connected or disconnected. N1 and N2 terminals are opened. Servo Drive failure 			○			I586
04B50000 hex	Inrush Current Prevention Circuit Error	An error of inrush current prevention circuit was detected.	Inrush current prevention circuit failure			○			I586
04B60000 hex	Regeneration Circuit Error	An regeneration circuit error was detected.	<ul style="list-style-type: none"> There is a short circuit between B2 and N2/N3 Regeneration circuit failure Noise into wiring of the external regeneration resistor 			○			I586 I621
05430000 hex	ESC Error	An error occurred in the EtherCAT slave communications controller.	<ul style="list-style-type: none"> Error of the EtherCAT slave communications controller or false detection when the AL status code is 0051 hex Error access from the non-OMRON EtherCAT master when the AL status code is 0050 hex 			○			I586 I621

Event code	Event name	Meaning	Assumed cause	Level					Reference
				M a j	P r t	M i n	O b s	I n f o	
08390000 hex	Power Module Error	An error was detected in the power module.	<ul style="list-style-type: none"> There is a short-circuit, ground fault, or contact failure on the U, V, or W motor cable There is a short-circuit on the wiring of External Regeneration Resistor or the resistance value is small The insulation resistance failed between the U, V, or W motor cable and the motor ground wire Servo Drive failure 			○			1586 1621
083B0000 hex	Self-diagnosis Error	An error was detected by the self-diagnosis of the safety function.	<ul style="list-style-type: none"> False detection due to a data read error that was caused by excessive noise Hardware failure 			○			1586 1621
083C0000 hex	Main Circuit Temperature Monitoring Circuit Failure	A temperature monitoring circuit failure was detected on the main circuit.	Broken wiring of the thermistor, temperature monitoring circuit failure			○			1586 1621
083D0000 hex	Fan Error	The rotation speed of the fan is 40% or less of the rating and the cooling performance decreases.	<ul style="list-style-type: none"> There is a foreign matter in the cooling fan and it blocks the rotation Cooling fan failure 			○			1586 1621
083F0000 hex	Regeneration Processing Error	The regeneration processing was stopped to protect the Regeneration Resistor.	<ul style="list-style-type: none"> The regeneration processing is set inappropriately The Regeneration Resistor is selected inappropriately The Regeneration Resistor is used for continuous regenerative braking The applied power supply voltage is higher than the specified value Regeneration Resistor failure 			○			1586 1621
08410000 hex	Overvoltage Error	The main circuit power supply voltage (P-N voltage) exceeded the operation guarantee range.	<ul style="list-style-type: none"> The P-N voltage exceeded the specified value The input voltage increased The Regeneration Resistor wiring is broken The External Regeneration Resistor is set or selected inappropriately Servo Drive failure 			○			1586 1621
08420000 hex	Motor Overheat Error	The encoder detected the temperature that exceeded the protection level of motor.	<ul style="list-style-type: none"> The temperature is high around the motor The motor is overloaded Encoder failure 			○			1586

Event code	Event name	Meaning	Assumed cause	Level					Reference
				M a j	P r t	M i n	O b s	I n f o	
08430000 hex	1-rotation Counter Error	The encoder detected a one-rotation counter error.	<ul style="list-style-type: none"> There is excessive noise Failure due to vibration, impact, condensation, foreign matter, etc. 			○			I586 I621
08440000 hex	Overspeed Error	The encoder detected the overspeed.	<ul style="list-style-type: none"> The motor was rotated by external forces Encoder failure and false detection 			○			I586
08450000 hex	Encoder Memory Error	The encoder detected a nonvolatile memory error.	<ul style="list-style-type: none"> False detection due to a data read error that was caused by excessive noise Non-volatile memory failure 			○			I586 I621
08460000 hex	Absolute Position Detection Error	The encoder detected a multi-rotation counter error.	<ul style="list-style-type: none"> A detection error was detected in the multi-rotation detection section of the encoder There is excessive noise 			○			I586 I621
08480000 hex	Main Power Supply Undervoltage (insufficient voltage between P and N)	The main circuit power supply voltage fell below the operation guarantee range during Servo ON.	<ul style="list-style-type: none"> Incorrect wiring of the main circuit power supply The low power supply voltage is applied to the Servo Drive The long time was set in Momentary Hold Time and the voltage was decreased momentarily Servo Drive failure 			○			I586 I621
08490000 hex	Overcurrent Error	The current flowing to the motor exceeded the protection level.	<ul style="list-style-type: none"> There is a short-circuit, ground fault, or contact failure on the U, V, or W motor cable There is a short-circuit on the wiring of External Regeneration Resistor The insulation resistance failed between the U, V, or W motor cable and the motor ground wire False detection due to the noise Servo Drive failure 			○			I586 I621
084A0000 hex	Encoder Communications Disconnection Error	The communications disconnection was detected between the encoder and the Servo Drive.	<ul style="list-style-type: none"> Noise into the encoder cable Contact failure of the signal line, and disconnection of the encoder Power supply undervoltage to the encoder Encoder failure 			○			I586
084B0000 hex	Encoder Communications Error	Illegal data was received from the encoder the specified number of times.	<ul style="list-style-type: none"> Noise into the encoder cable Contact failure of the signal line, and disconnection of the encoder Power supply undervoltage to the encoder 			○			I586 I621

A

Event code	Event name	Meaning	Assumed cause	Level					Reference
				M a j	P r t	M i n	O b s	I n f o	
084D0000 hex	Non-volatile Memory Hardware Error	An error occurred in non-volatile memory.	<ul style="list-style-type: none"> False detection due to a data read error that was caused by excessive noise Non-volatile memory failure 			○			1586 1621
086D0000 hex	Motor Temperature Error	The encoder detected the temperature that exceeded the protection level of motor.	<ul style="list-style-type: none"> The temperature around the motor is not operating temperature The motor is overloaded Encoder failure 			○			1621
086E0000 hex	Encoder Error	The encoder detected the position information error.	<ul style="list-style-type: none"> Noise into the encoder Hardware failure from mechanical impact, and fault of power supply to the encoder. Contact failure of the signal line Encoder failure 			○			1621
086F0000 hex	Encoder power supply Error	Encoder power supply error was detected.	<ul style="list-style-type: none"> Noise into the encoder cable Contact failure of the signal line Power supply undervoltage to the encoder Encoder failure 			○			1621
08700000 hex	Encoder Self-diagnosis Error	An error was detected by the self-diagnosis of the encoder.	<ul style="list-style-type: none"> False detection due to a data read error that was caused by excessive noise Encoder failure 			○			1621
08710000 hex	Internal Circuit Error at SF Input	Internal circuit error at SF input terminal was detected.	<ul style="list-style-type: none"> Memory error or signal abnormality due to transient factors such as soft errors and excessive noise Failure of safety input circuit of Servo Drive 			○			1621
08720000 hex	Internal Circuit Error at SOPT Input	Internal circuit error was detected at SOPT input terminal.	<ul style="list-style-type: none"> Memory error or signal abnormality due to transient factors such as soft errors and excessive noise Failure of SOPT input circuit of Servo Drive 			○			1621
08730000 hex	Internal Circuit Error at Test Output	Internal circuit errors were detected at test output terminal.	<ul style="list-style-type: none"> Memory error or signal abnormality due to transient factors such as soft errors and excessive noise Failure of test output circuit of Servo Drive 			○			1621
08740000 hex	Internal Circuit Error at SBC Output	Internal circuit error was detected at SBC Output terminal.	<ul style="list-style-type: none"> Memory error or signal abnormality due to transient factors such as soft errors and excessive noise Failure of SBC output circuit of Servo Drive 			○			1621

Event code	Event name	Meaning	Assumed cause	Level					Reference
				M a j	P r t	M i n	O b s	I n f o	
08750000 hex	Overspeed Error	The encoder detected the overspeed.	<ul style="list-style-type: none"> The motor was rotated by external forces Encoder failure and the false detection 			○			I621
08760000 hex	Absolute Encoder Multi-rotation Counter Error	The encoder detected a multi-rotation counter error.	<ul style="list-style-type: none"> A temporary error occurred in the encoder multi-rotation detection function due to vibration, impact, or condensation Encoder failure 			○			I621
08780000 hex	Encoder Communications Disconnection Error	The communications disconnection was detected between the encoder and the Servo Drive.	<ul style="list-style-type: none"> Noise into the encoder cable Contact failure of the signal line, and No connection to the integrated cable Power supply undervoltage to the encoder Encoder failure 			○			I621
18230000 hex	Absolute Encoder Multi-rotation Counter Error	The encoder detected a multi-rotation counter error.	<ul style="list-style-type: none"> A temporary error occurred in the encoder multi-rotation detection function due to vibration, impact, or condensation Encoder failure 			○			I586
18380000 hex	System Error	A hardware error due to the self-diagnosis and a fatal soft error were detected.	<ul style="list-style-type: none"> False detection due to a data read error that was caused by excessive noise A fatal soft error was detected Hardware failure 			○			I586 I621
183A0000 hex	Non-volatile Memory Data Error	An error of data saved in the nonvolatile memory was detected.	<ul style="list-style-type: none"> Power interruption or noise occurred while parameters other than the safety were saved Power interruption or noise occurred while the motor identity information was saved Power interruption or noise occurred while safety parameters were saved 			○			I586 I621
246D0000 hex	Motor Non-conformity	The Servo Drive and motor combination is not correct.	<ul style="list-style-type: none"> The Servo Drive and motor combination is not correct 			○			I586 I621

A

Event code	Event name	Meaning	Assumed cause	Level					Reference
				M a j	P r t	M i n	O b s	I n f o	
28080000 hex	Main Circuit Power Supply Phase Loss Error	The phase loss of the main circuit power supply was detected.	<ul style="list-style-type: none"> Incorrect wiring, for example the single-phase power supply is input to a 3-phase input type Servo Drive In the case where the single-phase power supply is input to a single- and 3-phase input type Servo Drive, the phase loss detection is enabled. The power supply voltage is low or insufficient Broken wiring of the main circuit power supply input Servo Drive failure 			○			1586 1621
280D0000 hex	Runaway Detected	The motor rotated in the direction opposite to the command.	<ul style="list-style-type: none"> There is incorrect wiring of the motor cable or a broken cable. The motor rotated in the direction opposite to the command by external forces. 			○			1586 1621
357D0000 hex	DC Setting Error	A mistake was made in the DC Mode operation setting.	<ul style="list-style-type: none"> A mistake was made in the DC Mode operation setting 			○			1586 1621
357E0000 hex	Synchronization Cycle Setting Error	When the DC mode was established, the cycle time was set to the inoperable value.	<ul style="list-style-type: none"> The variable PDO mapping is used, and the number of objects is more than the maximum number of mapped objects for the cycle time The cycle time setting is incorrect 			○			1586 1621
357F0000 hex	Mailbox Setting Error	An incorrect mailbox setting of Sync Manager was detected.	<ul style="list-style-type: none"> An incorrect mailbox setting of Sync Manager was detected 			○			1586 1621
35800000 hex	RxPDO Setting Error	An RxPDO setting error was detected.	<ul style="list-style-type: none"> The RxPDO setting of EtherCAT master is incorrect Servo Drive failure 			○			1586 1621
35810000 hex	TxPDO Setting Error	A TxPDO setting error was detected.	<ul style="list-style-type: none"> The TxPDO setting of EtherCAT master is incorrect Servo Drive failure 			○			1586 1621
35820000 hex	RxPDO Mapping Error	An incorrect RxPDO was set.	<ul style="list-style-type: none"> An incorrect RxPDO was set, such as out of the allowable range of Index, Subindex, or size 			○			1586 1621
35830000 hex	TxPDO Mapping Error	An incorrect TxPDO was set.	<ul style="list-style-type: none"> An incorrect TxPDO was set, such as out of the allowable range of Index, Subindex, or size 			○			1586 1621
35840000 hex	PDO WDT Setting Error	An incorrect PDO WDT setting was detected.	<ul style="list-style-type: none"> An incorrect PDO WDT setting was detected 			○			1586 1621

Event code	Event name	Meaning	Assumed cause	Level					Reference
				M a j	P r t	M i n	O b s	I n f o	
35850000 hex	Node Address Updated	The node address is changed to a value of the ID switches.	<ul style="list-style-type: none"> The node address is changed from a set value in Sysmac Studio to a value of the ID switches 			○			I586 I621
35860000 hex	SM Event Mode Setting Error	The unsupported SM Event Mode was set.	<ul style="list-style-type: none"> The unsupported SM Event Mode was set 			○			I586 I621
38570000 hex	Function Setting Error	The function that was set does not support the communications period.	<ul style="list-style-type: none"> The electronic gear ratio was not 1:1 when the communications period was set to 125 μs. The Backlash Compensation was enabled when the communications period was set to 125 μs. 			○			I586 I621
38780000 hex	General Input Allocation Duplicate Error	More than one function input is allocated to one general input.	<ul style="list-style-type: none"> More than one function input is allocated to one general input 			○			I586 I621
38790000 hex	General Output Allocation Duplicate Error	More than one function output is allocated to one general output.	<ul style="list-style-type: none"> More than one function output is allocated to one general output 			○			I586 I621
387B0000 hex	Pulse Output Setting Error	The dividing numerator exceeded the dividing denominator when the Encoder Dividing Pulse Output - Dividing Denominator was set to a value other than 0.	<ul style="list-style-type: none"> The dividing numerator exceeded the dividing denominator when the Encoder Dividing Pulse Output - Dividing Denominator was set to a value other than 0 			○			I586 I621
387C0000 hex	Motor Replacement Detected	The connected motor is different from the motor that was connected the last time.	<ul style="list-style-type: none"> The motor was replaced The Servo Drive was replaced 			○			I586 I621
387F0000 hex	Electronic Gear Setting Error	The electronic gear ratio exceeded the allowable range.	<ul style="list-style-type: none"> The electronic gear ratio exceeded the allowable range 			○			I586 I621
38800000 hex	Servo Drive Overheat	The internal temperature of Servo Drive exceeded the circuit protection level.	<ul style="list-style-type: none"> The ambient temperature of the Servo Drive exceeded the specified value Overload 			○			I586 I621
38810000 hex	Overload Error	The Load Ratio of Servo Drive or motor (4150-81 hex) exceeded 100%.	<ul style="list-style-type: none"> Operation was continued for a long time with high load There is incorrect wiring of the motor cable or a broken cable Increase in friction 			○			I586 I621

Event code	Event name	Meaning	Assumed cause	Level					Reference
				M a j	P r t	M i n	O b s	I n f o	
38820000 hex	Regeneration Overload Error	The Regeneration Load Ratio (4310-81 hex) exceeded the regeneration overload ratio.	<ul style="list-style-type: none"> The regeneration processing is set inappropriately The Regeneration Resistor is selected inappropriately The Regeneration Resistor is used for continuous regenerative braking The applied power supply voltage is higher than the specified value Regeneration Resistor failure 			○			1586 1621
38830000 hex	Excessive Position Deviation Error	The position deviation is greater than or equal to the value set in the Following error window.	<ul style="list-style-type: none"> Motor operation does not follow the command The value of Following error window is small 			○			1586 1621
38840000 hex	Excessive Speed Deviation Error	The speed deviation is greater than or equal to the value set in the Excessive Velocity Deviation Detection Level.	<ul style="list-style-type: none"> The motor operation does not follow the command because a parameter value is inappropriate The output axis of motor is limited on the operation by external forces The value of the Excessive Velocity Deviation Detection Level is inappropriate 			○			1586 1621
38850000 hex	Excessive Speed Error	The feedback motor speed is greater than or equal to the value set in the Excessive Speed Detection Level.	<ul style="list-style-type: none"> The velocity command value is too large Overshooting occurred The motor was rotated by external forces 			○			1586 1621
38860000 hex	Following Error Counter Overflow	The following error value exceeded the range from -2147483648 to 2147483647.	<ul style="list-style-type: none"> The motor operation does not follow the command The motor is rotated or limited on the operation by external forces 			○			1586 1621
38870000 hex	Absolute Encoder Counter Overflow Error	The multi-rotation counter of the encoder exceeded the maximum number of rotations.	<ul style="list-style-type: none"> An inappropriate value was set in the Encoder - Operation Selection when Using Absolute Encoder (4510-01 hex) The multi-rotation number of the encoder exceeded the maximum number of rotations 			○			1586 1621

Event code	Event name	Meaning	Assumed cause	Level					Reference
				M a j	P r t	M i n	O b s	I n f o	
38880000 hex	Safety Communications Setting Error	Safety process data communications were not established with the Safety CPU Unit because of an incorrect communications setting.	<ul style="list-style-type: none"> The watchdog time was set incorrectly The processing was not completed within the watchdog time because communications were not established due to the noise 			○			I586 I621
38890000 hex	Safety Frame Error	Safety process data communications were not established with the Safety CPU Unit because an incorrect frame was received.	<ul style="list-style-type: none"> An incorrect frame was received in safety process data communications. There is excessive noise 			○			I586 I621
388A0000 hex	Safety Parameter Error	Safety process data communications were not established with the Safety CPU Unit because an incorrect parameter was received.	<ul style="list-style-type: none"> The set safety slave model is incorrect 			○			I586
388B0000 hex	FSoE Slave Address Error	Safety process data communications were not established with the Safety CPU Unit because of an incorrect FSoE slave address.	<ul style="list-style-type: none"> The setting of the FSoE slave address in the safety process data communications settings is different from the setting in the Unit 			○			I586 I621
38980000 hex	Safety Function Setting Error	Incorrect safety function setting was detected.	<ul style="list-style-type: none"> Safety function setting is broken Safety function setting is incorrect in the attached information 			○			I621
38990000 hex	Safety Parameter Error	Safety process data communications were not established with the Safety CPU Unit because an incorrect parameter was received.	<ul style="list-style-type: none"> The specified safety slave model is incorrect There is discrepancy between safety function setting downloaded to EtherCAT master and safety application data downloaded to safety controller 			○			I621
48080000 hex	FPGA WDT Error	An FPGA error was detected.	<ul style="list-style-type: none"> False detection due to a data read error that was caused by excessive noise Hardware failure 			○			I586 I621

Event code	Event name	Meaning	Assumed cause	Level					Reference
				M a j	P r t	M i n	O b s	I n f o	
64E30000 hex	Drive Prohibition Input Error	Both the Positive Drive Prohibition (POT) and the Negative Drive Prohibition Input (NOT) turned ON.	<ul style="list-style-type: none"> An error occurred on the switch, wire, power supply, and wiring that were connected to the Positive Drive Prohibition (POT) or Negative Drive Prohibition Input (NOT) False detection occurred because the control signal power supply was turned ON slowly 			○			1586 1621
68200000 hex	Drive Prohibition Detected	The operation was stopped according to the user setting because the motor ran in the prohibited direction when the Drive Prohibition was enabled.	<ul style="list-style-type: none"> Incorrect or broken wiring of Positive Drive Prohibition Input (POT) or Negative Drive Prohibition Input (NOT) Incorrect setting of the Drive Prohibition Input 			○			1586 1621
68210000 hex	Control Right Release Error	Communications between the Sysmac Studio and Servo Drive were interrupted while a specific function was used from the Sysmac Studio.	<ul style="list-style-type: none"> The USB cable or EtherCAT cable was disconnected during the connection with the Sysmac Studio There is excessive noise A command sent from the Sysmac Studio was not sent to the Servo Drive because the computer was in a busy state or the like 			○			1586 1621
68220000 hex	Error stop input	The Error Stop Input (ESTP) is active.	<ul style="list-style-type: none"> The Error Stop Input (ESTP) was input The Error Stop Input (ESTP) is incorrectly wired 			○			1586 1621
68230000 hex	Software Limit Exceeded	The Position actual value detected the position that exceeded the value set in the Software Position Limit, and stopped the operation according to the user setting.	<ul style="list-style-type: none"> Incorrect setting of Software Position Limit When the Software Position Limit - Stop Selection was set to Stop according to the setting of Fault reaction option code, the position exceeded the value set in the Software Position Limit 			○			1586 1621

Event code	Event name	Meaning	Assumed cause	Level					Reference
				M a j	P r t	M i n	O b s	I n f o	
68370000 hex	SOPT Input Monitoring Error	Improper installation of SOPT input device and the malfunction were detected.	<ul style="list-style-type: none"> Detected a gap of the installation positions of SOPT input devices The setting of Discrepancy Distance (4F00-05 hex) is inappropriate The setting of Safety Origin Position Offset (4F00-04 hex) is inappropriate The setting of Safety Origin Position Tolerance (4F00-06 hex) is inappropriate SOPT Input Terminal Setting is different from specification of input device Speed where a work passed SOPT1/SOPT2 exceeded 200 r/min Failure of input device Disconnection of input device connection cable 			○			I621
68380000 hex	Safety Function Error	A problem on use of safety functions is detected.	<ul style="list-style-type: none"> SLP function: Safety origin position is not determined SLP function: Discrepancy Distance is incorrectly set SLP function: Disconnection of cable for connection with SOPT input device SLS function: Operation of SLS command is not appropriate Safety Position/Velocity Validation Monitoring Function: A motor does not rotate as commanded or the overshooting occurs Safety Position/Velocity Validation Monitoring Function: External forces rotate a motor or limit the operation SOPT input device and encoder are broken 			○			I621
68390000 hex	Discrepancy Error at SF Input	Discrepancy between safety input1 and safety input2 was detected.	<ul style="list-style-type: none"> SF+ input contacts power line (+ side) with 24V DC Ground fault of SF+ input Disconnection of SF+ input or SF- input Short circuit of SF1+ input and SF2+ input Inappropriate safety controller setting or the failure 			○			I621



Event code	Event name	Meaning	Assumed cause	Level					Reference
				M a j	P r t	M i n	O b s	I n f o	
683A0000 hex	SBC Relay Diagnosis Error	Improper wiring of terminals between SBC RFB and an error of safety relay for SBC were detected.	<ul style="list-style-type: none"> Wrong wiring between a safety relay and SBC RFB terminals Safety Relay OFF Delay Time is inappropriate Safety Relay Activate is set inappropriately Wrong wiring of SBC RFB terminals Failure of safety relay 			○			1621
683B0000 hex	External Test Signal Failure at SOPT Input	An error was detected in test pulse diagnosis for SOPT input.	<ul style="list-style-type: none"> SOPT input wiring contacts IOV input wiring There is short circuit in the wiring of SOPT1 input and SOPT2 input Failure of externally connected equipment Test Pulse Diagnosis is set inappropriately 			○			1621
683C0000 hex	Overload Detected at Test Output	Overcurrent was detected at the test output terminals.	<ul style="list-style-type: none"> Ground fault of the test output to IOG input Failure of externally connected equipment 			○			1621
683D0000 hex	Stuck-at-high Detected at Test Output	Stuck ON was detected at test output terminals.	<ul style="list-style-type: none"> The wiring of the test output contacts the wiring of IOV input There is short circuit in SOPT1 input and SOPT2 input Memory abnormality or signal abnormality due to transient factors such as soft errors and excessive noise Failure of the test output circuit of Servo Drive 			○			1621
683E0000 hex	Overload Detected at SBC Output	Overcurrent was detected at the SBC output terminal.	<ul style="list-style-type: none"> Ground fault of SBC+ output to SBC CM input The wiring of SBC- output contacts SBC PS input Output of a power supply is out of specifications Memory error or signal abnormality due to transient factors such as soft errors and excessive noise Failure of SBC circuit of Servo Drive 			○			1621

Event code	Event name	Meaning	Assumed cause	Level					Reference
				M a j	P r t	M i n	O b s	I n f o	
683F0000 hex	Stuck-at-high Detected at SBC Output	Stuck ON was detected at the SBC output terminals.	<ul style="list-style-type: none"> The wiring of SBC+ output contacts SBC PS input Ground fault of SBC- output to IOG input Memory error or signal abnormality due to transient factors such as soft errors and excessive noise Failure of SBC circuit of Servo Drive 			○			I621
68400000 hex	IOV Power Supply Voltage Error	Voltage error of IOV power supply was detected.	<ul style="list-style-type: none"> IOV power supply is not turned on Overvoltage of IOV power supply 			○			I621
68410000 hex	SBC Power Supply Voltage Error	Voltage error of SBC power supply was detected.	<ul style="list-style-type: none"> SBC power supply is not turned on Overvoltage of the SBC power supply 			○			I621

A

Event code	Event name	Meaning	Assumed cause	Level					Reference
				M a j	P r t	M i n	O b s	I n f o	
68420000 hex	Monitoring Limit Exceedance Error	A monitoring error was detected in safety monitoring functions.	a. Each position and velocity exceeded a monitoring range/limit for safety monitoring functions <ul style="list-style-type: none"> SOS function: Safety Current Pulse Position exceeded SOS position zero window. Safety Current Motor Velocity exceeded SOS velocity zero window SLS function: Safety Current Motor Velocity exceeded SLS velocity limit SLP function: Safety Current Position exceeded a range from SLP Monitoring Upper Limit Position to SLP Monitoring Lower Limit Position SDI function: Safety Current Motor Velocity exceeded SDI velocity zero window to rotation limit direction. And, Safety Current Pulse Position exceeded SDI position zero window to rotation limit direction b. Safety Position/Velocity Validation Monitoring Function: The monitoring limit values/ranges for the safety functions are set lower than the allowable ranges of the safety position/the velocity appropriateness monitoring function					○	1621
78200000 hex	Pulse Output Overspeed Error	The speed, which exceeded the frequency that could be output by the Encoder Dividing Pulse Output function, was detected.	<ul style="list-style-type: none"> The dividing ratio setting is inappropriate for the actual usage condition 					○	1586 1621

Event code	Event name	Meaning	Assumed cause	Level					Reference
				M a j	P r t	M i n	O b s	I n f o	
78210000 hex	Brake Interlock Error	The Brake Interlock Output (BKIR) was output by the Timeout at Servo OFF.	<ul style="list-style-type: none"> The Brake Interlock Output (BKIR) was output because the motor rotation speed did not decrease to or less than the speed set in the Threshold Speed at Servo OFF within the time set in the Timeout at Servo OFF when Servo OFF was performed during the motor operation 			○			I586 I621
78230000 hex	Command Error	A mistake was made in using a command.	<ul style="list-style-type: none"> When bit 9 (Remote) of the Statusword was set to 1 (remote), and the Servo Drive was in Operation enabled state (Servo ON), the Servo Drive received a command to change the communications state from Operational to another state (Init, Pre-Operational, or Safe-Operational) A mode of operation other than the hm mode was set during the homing operation Modes of operation was set to pp, pv or hm mode when the communications period was set to shorter than 250 μs 			○			I586 I621
84B10000 hex	EtherCAT State Change Error	A communications state change command was received for which the current communications state could not be changed.	<ul style="list-style-type: none"> A communications state change command was received for which the current communications state could not be changed 			○			I586 I621
84B20000 hex	EtherCAT Illegal State Change Error	An undefined communications state change command was received.	<ul style="list-style-type: none"> An undefined communications state change command was received 			○			I586 I621
84B40000 hex	Synchronization Error	A signal for synchronous communications could not be detected.	<ul style="list-style-type: none"> Noise Error of the EtherCAT slave communications controller 			○			I586 I621
84B50000 hex	Sync Manager WDT Error	PDO communications were interrupted for the allowable period or longer.	<ul style="list-style-type: none"> An EtherCAT communications cable is disconnected, loose, or broken Host controller error 			○			I586 I621
84B60000 hex	ESC Initialization Error	Initialization of the EtherCAT slave communications controller failed.	<ul style="list-style-type: none"> Data was incorrectly overwritten in the non-volatile memory of the EtherCAT slave communications controller Failure of the EtherCAT slave communications controller 			○			I586 I621

Event code	Event name	Meaning	Assumed cause	Level					Reference
				M a j	P r t	M i n	O b s	I n f o	
84B70000 hex	SII Verifica- tion Error	An error occurred in SII data of the EtherCAT slave communications controller.	<ul style="list-style-type: none"> Data was incorrectly overwritten in the non-volatile memory of the EtherCAT slave communications controller Failure of the EtherCAT slave communications controller or false detection 				○		1586 1621
84B90000 hex	Synchroni- zation Inter- ruption Error	Synchronization inter- ruption did not occur within the specified period	<ul style="list-style-type: none"> Incorrect EtherCAT synchroni- zation setting of the host con- troller Failure of the EtherCAT slave communications controller or false detection 				○		1586 1621
84BA0000 hex	Bootstrap State Transi- tion Request Error	The state transition to unsupported Boot- strap was requested.	<ul style="list-style-type: none"> The EtherCAT master request- ed the transition of unsupport- ed Bootstrap 				○		1586 1621
88100000 hex	Communica- tions Syn- chronization Error	Communications were not established consecutively be- cause the synchroni- zation with the Ether- CAT Master could not be achieved.	<ul style="list-style-type: none"> The power supply to the host controller was interrupted dur- ing PDO communications An EtherCAT communications cable is disconnected, loose, broken, or has a contact failure Noise 				○		1586 1621
88120000 hex	Safety Com- munications Timeout	A communications timeout occurred in safety process data communications with the Safety CPU Unit.	<ul style="list-style-type: none"> A setting is not correct. The setting of the safety task peri- od of the Safety CPU Unit is too short There is excessive noise The Safety CPU Unit or safety slave entered a status where it could not continue safety pro- cess data communications 				○		1586 1621
98200000 hex	Absolute Value Cleared	The multi-rotation counter of the abso- lute encoder was cleared.	<ul style="list-style-type: none"> The multi-rotation counter of the absolute encoder was cleared 				○		1586 1621
081C0000 hex	Capacitor Lifetime Warning	The capacitor built in- to the Servo Drive reached the service life.	<ul style="list-style-type: none"> The operating time of the ca- pacitor in the Servo Drive ex- ceeded the service life 				○		1586 1621
081D0000 hex	Inrush Cur- rent Preven- tion Relay Lifetime Warning	The inrush current prevention relay built into the Servo Drive reached the service life.	<ul style="list-style-type: none"> The number of operating times of the inrush current preven- tion relay in the Servo Drive exceeded the service life 				○		1586 1621
081F0000 hex	Brake Inter- lock Output Relay Life- time Warn- ing	The brake interlock output (BKIR) relay built into the Servo Drive reached the service life.	<ul style="list-style-type: none"> The number of operating times of the brake interlock output in the Servo Drive exceeded the service life 				○		1586

Event code	Event name	Meaning	Assumed cause	Level					Reference
				M a j	P r t	M i n	O b s	I n f o	
083A0000 hex	Encoder Communications Warning	Encoder communications errors occurred in series more frequently than the specified value.	<ul style="list-style-type: none"> Power supply undervoltage to the encoder Noise into the encoder cable Contact failure of the encoder cable 				○		I586
08470000 hex	Encoder Lifetime Warning	The encoder lifetime is close to the end.	<ul style="list-style-type: none"> Temporary noise The end of the encoder life 				○		I586 I621
084C0000 hex	Fan Rotation Warning	The rotation speed of the fan is 80% or less of the rating and the cooling performance decreases.	<ul style="list-style-type: none"> There is a foreign matter in the cooling fan and it blocks the rotation Cooling fan failure 				○		I586 I621
084E0000 hex	Absolute Encoder Counter Overflow Warning	The multi-rotation counter of the encoder exceeded the value set in Encoder - Absolute Encoder Counter Overflow Warning Level (4510-02 hex).	<ul style="list-style-type: none"> An inappropriate value was set in the Encoder - Operation Selection (4510-01 hex) The multi-rotation number of the encoder exceeded the warning level 				○		I586 I621
08770000 hex	Safety Relay Lifetime Warning	A safety relay for SBC reached the lifetime counting.	Use numbers of safety relay for SBC surpassed Safety Relay Lifetime Warning Detection Threshold				○		I621
18390000 hex	Lifetime Information Corruption Warning	An error was detected in the saved lifetime information.	<ul style="list-style-type: none"> The lifetime information corruption was detected when the power supply was turned ON 				○		I586 I621
34E00000 hex	Data Setting Warning	The object set value is out of the range.	<ul style="list-style-type: none"> The object set value is out of the range 				○		I586 I621
387A0000 hex	Overload Warning	The Load Ratio of Servo Drive or motor (4150-81 hex) exceeded the level set in Overload - Warning Notification Level (4150-01 hex).	<ul style="list-style-type: none"> Operation was continued for a long time with high load. There is incorrect wiring of the motor cable or a broken cable Increase in friction 				○		I586 I621
387D0000 hex	Regeneration Overload Warning	The Regeneration Load Ratio (4310-81Hex) exceeded 85% of the regeneration overload ratio.	<ul style="list-style-type: none"> The regeneration processing is set inappropriately The Regeneration Resistor is selected inappropriately The Regeneration Resistor is used for continuous regenerative braking The applied power supply voltage is higher than the specified value Regeneration Resistor failure 				○		I586 I621



Event code	Event name	Meaning	Assumed cause	Level					Reference
				M a j	P r t	M i n	O b s	I n f o	
387E0000 hex	Motor Vibration Warning	The motor vibration, which was higher than or equal to the level set in the Vibration Detection - Detection Level (3B70-01 hex), was detected.	<ul style="list-style-type: none"> The control parameter is set inappropriately The rigidity decreased due to mechanical looseness or wear 				○		1586 1621
78220000 hex	Command Warning	A command could not be executed.	<ul style="list-style-type: none"> The Switch ON command was received The Enable operation command was received An operation command in the prohibition direction was received after the immediate stop by the Drive Prohibition Input or Software Position Limit Homing started The positioning start command was received in the Profile position mode 				○		1586 1621
84B00000 hex	EtherCAT Communications Warning	An EtherCAT communications error occurred more than one time.	<ul style="list-style-type: none"> An EtherCAT communications cable has a contact failure, or is connected incorrectly or broken Noise 				○		1586 1621
90A00000 hex	Unit Restarted	Restart was performed.	Restart was performed				○		1586 1621
98210000 hex	STO Detected	The safety input OFF state was detected via the safety input signal or EtherCAT communications.	<ul style="list-style-type: none"> The cable is disconnected or broken The STO input was turned OFF via EtherCAT communications 				○		1586
98220000 hex	Memory All Cleared	The Unit setting was cleared.	<ul style="list-style-type: none"> Clear All Memory was performed 				○		1586 1621
98230000 hex	Motor Rotation Direction Selection Non-conformity	Discrepancy of Motor Rotation Direction Selection and Safety Motor Rotation Direction Selection was detected.	Motor rotation settings are different between Motor Rotation Direction Selection and Safety Motor Rotation Direction Selection				○		1621
98240000 hex	Event Log Cleared	The event log was cleared.	Clear Event Log was performed				○		1586 1621

Event code	Event name	Meaning	Assumed cause	Level					Reference
				M a j	P r t	M i n	O b s	I n f o	
98250000 hex	STO Detect- ed	The safety input OFF state was detected via the safety input signal or EtherCAT communications.	<ul style="list-style-type: none"> • There are detached wires and the disconnection of safety input cable • Incorrect safety programming of safety controller • Torque off request was detected at safety input signal • Torque off request was detected by commands via EtherCAT communication 					○	I621

Servo G5 (G5-series AC Servo Drives with Built-in EtherCAT Communications) and G5 Linear (G5-series Linear Motors/Drives with Built-in EtherCAT Communications Linear Motor Type)

The manual names are given below for the catalog numbers given in the Reference column of the event table.

Cat. No.	Manual name
I576	AC Servomotors/Servo Drives G5-series with Built-in EtherCAT Communications User's Manual
I577	AC Servomotors/Servo Drives G5-series with Built-in EtherCAT Communications Linear Motor Type User's Manual

Event code	Event name	Meaning	Assumed cause	Level					Reference
				M a j	P r t	M i n	O b s	I n f o	
04A80000 hex	Control Power Supply Undervoltage	The voltage between the positive and negative terminals in the control power supply converter dropped below the specified value.	<ul style="list-style-type: none"> Power supply undervoltage. Or, the power supply voltage dropped because there was in-rush current when the main power supply was turned ON. A momentary power interruption occurred. The Servo Drive failed. 			○			I576 I577
04A90000 hex	Overvoltage	The power supply voltage exceeded the allowable input voltage range.	<ul style="list-style-type: none"> The voltage between the positive and negative terminals in the control power supply converter exceeded the specified value. The voltage was suddenly increased by the phase advance capacitor or the uninterruptible power supply (UPS). The Regeneration Resistor wiring is broken. The External Regeneration Resistor is not suitable. The Servo Drive failed. 			○			I576 I577

Event code	Event name	Meaning	Assumed cause	Level					Reference
				M a j	P r t	M i n	O b s	I n f o	
04AA0000 hex	Main Circuit Power Supply Undervoltage (Undervoltage between positive and negative terminals)	If the Undervoltage Error Selection (3508 hex) is set to 1, a momentary power interruption occurred between L1 and L3 for longer than the value specified for the Momentary Hold Time. The voltage between the positive and negative terminals in the main power supply converter dropped below the specified value while the Servo was ON.	<ul style="list-style-type: none"> Insufficient power supply capacity The electromagnetic contactor in the main circuit power supply was tripped. A momentary power interruption occurred. A Servo Drive with 3-phase input specifications was operated with a single-phase power supply. The Servo Drive failed. 			○			I576 I577
04AB0000 hex	Main Circuit Power Supply Undervoltage (AC Cutoff Detected)	If the Undervoltage Error Selection (3508 hex) is set to 1, a momentary power interruption occurred between L1 and L3 for longer than the value specified for the Momentary Hold Time. The voltage between the positive and negative terminals in the main power supply converter dropped below the specified value while the Servo was ON.	<ul style="list-style-type: none"> Insufficient power supply capacity The electromagnetic contactor in the main circuit power supply was tripped. A momentary power interruption occurred. A Servo Drive with 3-phase input specifications was operated with a single-phase power supply. The Servo Drive failed. 			○			I576 I577
04AC0000 hex	Overcurrent	The current flowing through the converter exceeded the specified value.	<ul style="list-style-type: none"> A short-circuit, line-to-ground fault, contact failure, or insulation failure occurred on the U, V, or W motor line. The Servo Drive failed. The relay for the dynamic brake has been welded due to frequent Servo ON/OFF operations. Motor windings are burned out. The Servomotor is not suitable for the Servo Drive. The command input timing is the same as or earlier than the Servo ON timing. 			○			I576 I577

Event code	Event name	Meaning	Assumed cause	Level					Reference
				M a j	P r t	M i n	O b s	I n f o	
04AD0000 hex	IPM Error	The current flowing through the converter exceeded the specified value.	<ul style="list-style-type: none"> A short-circuit, line-to-ground fault, contact failure, or insulation failure occurred on the U, V, or W motor line. The Servo Drive failed. The relay for the dynamic brake has been welded due to frequent Servo ON/OFF operations. Motor windings are burned out. The Servomotor is not suitable for the Servo Drive. The pulse input timing is the same as or earlier than the Servo ON timing. 			○			1576 1577
04AE0000 hex	Regeneration Tr Error	The Servo Drive regeneration drive Tr is faulty.	<ul style="list-style-type: none"> The Servo Drive regeneration drive Tr is faulty. 			○			1576 1577
04AF0000 hex	Encoder Phase-Z Error	A missing serial incremental encoder phase-Z pulse was detected.	<ul style="list-style-type: none"> The encoder is faulty. 			○			1576
04B00000 hex	Encoder CTS Signal Error	A missing serial incremental encoder CTS signal logic error was detected.	<ul style="list-style-type: none"> The encoder is faulty. 			○			1576
04B10000 hex	Node Address Setting Error	The node address that was read from the rotary switches was not between 00 and 99.	<ul style="list-style-type: none"> The Servo Drive failed. 			○			1576 1577
04B20000 hex	Other Errors	The Servo Drive malfunctioned, or an error occurred in the Servo Drive.	<ul style="list-style-type: none"> The control circuit malfunctioned temporarily due to excess noise. The Servo Drive's self-diagnosis function detected an error in the Servo Drive. 			○			1577
08080000 hex	Encoder Communications Disconnection Error	A disconnection was detected because communications between the encoder and the Servo Drive were stopped more frequently than the specified value.	<ul style="list-style-type: none"> The encoder is not wired correctly. 			○			1576
08090000 hex	Encoder Communications Error	There is a communications error for the encoder.	<ul style="list-style-type: none"> The power supply voltage of the encoder is low. Noise 			○			1576

Event code	Event name	Meaning	Assumed cause	Level					Reference
				M a j	P r t	M i n	O b s	I n f o	
080A0000 hex	Encoder Communications Data Error	There is an error in the communications data of the encoder.	<ul style="list-style-type: none"> The power supply voltage of the encoder is low. Noise 			○			I576
080B0000 hex	Safety Input Error	At least one of the input photocouplers for safety inputs 1 and 2 turned OFF.	<ul style="list-style-type: none"> The cable is disconnected or broken. 			○			I576 I577
080C0000 hex	External Encoder Connection Error	A disconnection was detected because communications between the external encoder and the Servo Drive were stopped more frequently than the specified value.	<ul style="list-style-type: none"> The wiring is incorrect. 			○			I576 I577
080D0000 hex	External Encoder Communications Data Error	There was a communications error in data from the external encoder.	<ul style="list-style-type: none"> There is insufficient external encoder power supply voltage. Noise 			○			I576 I577
080E0000 hex	External Encoder Status Error 0	Bit 00 of the external encoder error code (ALMC) was set to 1.	<ul style="list-style-type: none"> Bit 00 of the external encoder error code (ALMC) was set to 1. 			○			I576 I577
080F0000 hex	External Encoder Status Error 1	Bit 01 of the external encoder error code (ALMC) was set to 1.	<ul style="list-style-type: none"> Bit 01 of the external encoder error code (ALMC) was set to 1. 			○			I576 I577
08100000 hex	External Encoder Status Error 2	Bit 02 of the external encoder error code (ALMC) was set to 1.	<ul style="list-style-type: none"> Bit 02 of the external encoder error code (ALMC) was set to 1. 			○			I576 I577
08110000 hex	External Encoder Status Error 3	Bit 03 of the external encoder error code (ALMC) was set to 1.	<ul style="list-style-type: none"> Bit 03 of the external encoder error code (ALMC) was set to 1. 			○			I576 I577
08120000 hex	External Encoder Status Error 4	Bit 04 of the external encoder error code (ALMC) was set to 1.	<ul style="list-style-type: none"> Bit 04 of the external encoder error code (ALMC) was set to 1. 			○			I576 I577
08130000 hex	External Encoder Status Error 5	Bit 05 of the external encoder error code (ALMC) was set to 1.	<ul style="list-style-type: none"> Bit 05 of the external encoder error code (ALMC) was set to 1. 			○			I576 I577
08140000 hex	Phase-A Connection Error	An error such as broken wiring was detected in the external encoder phase-A connection.	<ul style="list-style-type: none"> An error such as broken wiring was detected in the external encoder phase-A connection. 			○			I576 I577
08150000 hex	Phase-B Connection Error	An error such as broken wiring was detected in the external encoder phase-B connection.	<ul style="list-style-type: none"> An error such as broken wiring was detected in the external encoder phase-B connection. 			○			I576 I577

Event code	Event name	Meaning	Assumed cause	Level					Reference	
				M a j	P r t	M i n	O b s	I n f o		
08160000 hex	Phase-Z Connection Error	An error such as broken wiring was detected in the external encoder phase-Z connection.	<ul style="list-style-type: none"> An error such as broken wiring was detected in the external encoder phase-Z connection. 					○		1576 1577
08170000 hex	Encoder Data Restoration Error	Initialization of internal position data was not processed correctly in Semi-closed Control Mode and Absolute Value Mode.	<ul style="list-style-type: none"> There is insufficient power supply voltage for the encoder. Noise is entering on the encoder line. 					○		1576
08180000 hex	External Encoder Data Restoration Error	Initialization of internal position data was not processed correctly in Fully-closed Control Mode and Absolute Value Mode.	<ul style="list-style-type: none"> There is insufficient power supply voltage for the external encoder. Noise is entering on the external encoder line. 					○		1576
14A80000 hex	Object Error	The object area data in non-volatile memory is corrupted.	<ul style="list-style-type: none"> Noise Non-volatile memory failure 					○		1576 1577
14A90000 hex	Object Error	The object area data in non-volatile memory is corrupted.	<ul style="list-style-type: none"> Noise Non-volatile memory failure 					○		1576 1577
14AA0000 hex	Object Error	The object area data in non-volatile memory is corrupted.	<ul style="list-style-type: none"> Noise Non-volatile memory failure 					○		1576 1577
14AB0000 hex	Object Corrupted	The checksum data in non-volatile memory is corrupted.	<ul style="list-style-type: none"> Non-volatile memory failure 					○		1576 1577
14AC0000 hex	Object Corrupted	The checksum data in non-volatile memory is corrupted.	<ul style="list-style-type: none"> Non-volatile memory failure 					○		1576 1577
14AD0000 hex	Object Corrupted	The checksum data in non-volatile memory is corrupted.	<ul style="list-style-type: none"> Non-volatile memory failure 					○		1576 1577
18200000 hex	Absolute Encoder Over-speed Error	The Servomotor rotation speed exceeded the specified value when only the battery power supply was used during a power interruption.	<ul style="list-style-type: none"> There is insufficient power supply voltage for the encoder. The wiring of the CN2 connector is wrong. An external force is rotating the motor when the Servo is OFF. 					○		1576
18210000 hex	Encoder Initialization Error	An encoder initialization error was detected.	<ul style="list-style-type: none"> Servomotor failed. 					○		1576
18220000 hex	Absolute Encoder One-rotation Counter Error	The encoder detected a one-rotation counter error.	<ul style="list-style-type: none"> Servomotor failed. 					○		1576

Event code	Event name	Meaning	Assumed cause	Level					Reference
				M a j	P r t	M i n	O b s	I n f o	
18230000 hex	Absolute Encoder Multi-rotation Counter Error	The encoder detected a multi-rotation counter error.	<ul style="list-style-type: none"> Servomotor failed. 			○			I576
24680000 hex	Motor Non-conformity	The Servo Drive and Servomotor combination is not correct.	<ul style="list-style-type: none"> The Servo Drive and motor combination is not correct 			○			I576
24690000 hex	Motor Non-conformity	The Servo Drive and Servomotor combination is not correct.	<ul style="list-style-type: none"> The Servo Drive and motor combination is not correct 			○			I576
246A0000 hex	Motor Non-conformity	The Servo Drive and Servomotor combination is not correct.	<ul style="list-style-type: none"> The Servo Drive and Servomotor combination is not correct. 			○			I576
246B0000 hex	Motor Non-conformity	The Servo Drive and Servomotor combination is not correct.	<ul style="list-style-type: none"> The Servo Drive and Servomotor combination is not correct. 			○			I576
246C0000 hex	Motor Non-conformity	The Servo Drive and Servomotor combination is not correct.	<ul style="list-style-type: none"> The Servo Drive and Servomotor combination is not correct. 			○			I576
28010000 hex	Motor Setting Error	Settings associated with the motor and external encoder are missing.	Settings associated with the motor and external encoder are missing.			○			I577
28020000 hex	Motor Combination Error 1	The value set for the motor current exceeds the maximum motor capacity allowed for the Servo Drive.	The Motor Rated Rms Current/ Motor Peak Absolute Current exceeds the maximum motor capacity allowed for the Servo Drive.			○			I577
28030000 hex	Motor Combination Error 2	The value set for the motor exceeds the drive range of the motor.	<ul style="list-style-type: none"> The Motor Rated Rms Current is too low compared with the maximum motor capacity of the Servo Drive. The percentage of the Motor Coil Unit Mass to the Motor Rated Force is too high. The automatically adjusted Current Loop Proportional Gain/Current Loop Integral Gain is too high. The percentage of the Motor Peak Absolute Current to the Motor Rated Rms Current is greater than 500%. 			○			I577
34E10000 hex	Servo Drive Overheat	The temperature of the Servo Drive radiator or power elements exceeded the specified value.	<ul style="list-style-type: none"> The ambient temperature of the Servo Drive exceeded the specified value. Overload 			○			I576 I577



Event code	Event name	Meaning	Assumed cause	Level					Reference
				M a j	P r t	M i n	O b s	I n f o	
34E20000 hex	Overload	When the feedback value for torque/force command exceeds the overload level specified in the Overload Detection Level Setting (3512 hex), overload protection is performed according to the overload characteristics.	<ul style="list-style-type: none"> Operation was continued for a long time while overloaded. There is incorrect wiring of the motor line or a broken cable. 				○		1576 1577
34E30000 hex	Regeneration Overload	The regenerative energy exceeds the processing capacity of the Regeneration Resistor.	<ul style="list-style-type: none"> The load inertia/load mass is too large. Or, the Servomotor rotation speed/motor speed is too high to absorb the regenerative energy within the specified deceleration time. This Regeneration Resistor cannot be used for continuous regenerative braking. (The operating limit of the external resistor is limited to a 10% duty.) 				○		1576 1577
34E40000 hex	Error Counter Overflow	Position error pulses exceeded the setting of the Following error window (6065 hex).	<ul style="list-style-type: none"> Motor operation does not follow the command. The value of the Following error window (6065 hex) is small. The encoder/external encoder wiring is incorrect. 				○		1576 1577
34E50000 hex	Excessive Velocity Error	The difference between the internal position command velocity and the actual velocity (i.e., the velocity error) exceeded the Excessive Velocity Error Setting (3602 hex).	<ul style="list-style-type: none"> Motor operation does not follow the command. The setting of the Excessive Velocity Error Setting (3602 hex) is too small. 				○		1576 1577
34E60000 hex	Overspeed	The Servomotor rotation speed/motor speed exceeded the value set on the Overspeed Detection Level Setting (3513 hex).	<ul style="list-style-type: none"> The velocity command value is too large. There is overshooting. The wiring is incorrect. 				○		1576 1577

Event code	Event name	Meaning	Assumed cause	Level					Reference
				M a j	P r t	M i n	O b s	I n f o	
383F0000 hex	Excessive Hybrid Following Error	During fully-closed control, the difference between the load position from the external encoder and the Servomotor position from the encoder was larger than the number of pulses set as the Hybrid Following Error Counter Overflow Level (3328 hex).	<ul style="list-style-type: none"> • Connections are not correct. • The settings are not correct. 			○			I576
38400000 hex	Overspeed 2	The Servomotor rotation speed/motor speed exceeded the value set on Overspeed Detection Level Setting at Immediate Stop (3615 hex).	<ul style="list-style-type: none"> • The velocity command value is too large. • There is overshooting. • The wiring is incorrect. 			○			I576 I577
38410000 hex	Command Error	The position command variation after the electronic gear exceeded the specified value.	<ul style="list-style-type: none"> • The change in position command is too large. • The backlash compensation amount is too large. 			○			I576 I577
38420000 hex	Command Generation Error	During position command processing, an error such as a calculation range error occurred.	<ul style="list-style-type: none"> • During position command processing, an error such as a calculation range error occurred. 			○			I576 I577
38430000 hex	Error Counter Overflow 1	The absolute encoder position/ absolute scale position in pulses divided by the electronic gear ratio exceeded $\pm 2^{31}(2,147,483,648)$.	<ul style="list-style-type: none"> • The absolute encoder position/ absolute scale position in pulses divided by the electronic gear ratio exceeded $\pm 2^{31}(2,147,483,648)$. 			○			I576 I577
38440000 hex	Error Counter Overflow 2	The position following error in pulses exceeded $\pm 2^{29}(536,870,912)$. Or, the position following error in command units exceeded $\pm 2^{30}(1,073,741,824)$.	<ul style="list-style-type: none"> • There is insufficient torque/ force. • There is insufficient gain. • The encoder/external encoder wiring is incorrect. 			○			I576 I577
38450000 hex	Interface Input Duplicate Allocation Error 1	There is a duplicate setting in the input signal (IN1, IN2, IN3, and IN4) function allocations.	<ul style="list-style-type: none"> • There is a duplicate setting in the input signal (IN1, IN2, IN3, and IN4) function allocations. 			○			I576 I577



Event code	Event name	Meaning	Assumed cause	Level					Reference
				M a j	P r t	M i n	O b s	I n f o	
38460000 hex	Interface Input Duplicate Allocation Error 2	There is a duplicate setting in the input signal (IN5, IN6, IN7, and IN8) function allocations.	<ul style="list-style-type: none"> There is a duplicate setting in the input signal (IN5, IN6, IN7, and IN8) function allocations. 				○		1576 1577
38470000 hex	Interface Input Function Number Error 1	There is an undefined number specification in the input signal (IN1, IN2, IN3, and IN4) function allocations. Or, a logic setting error was detected.	<ul style="list-style-type: none"> There is an undefined number specification in the input signal (IN1, IN2, IN3, and IN4) function allocations. Different logic is set for the same function in the function assignments of the input signals (IN1, IN2, IN3, and IN4). 				○		1576 1577
38480000 hex	Interface Input Function Number Error 2	There is an undefined number specification in the input signal (IN5, IN6, IN7, and IN8) function allocations. Or, a logic setting error was detected.	<ul style="list-style-type: none"> There is an undefined number specification in the input signal (IN5, IN6, IN7, and IN8) function allocations. Different logic is set for the same function in the function assignments of the input signals (IN5, IN6, IN7, and IN8). 				○		1576 1577
38490000 hex	Interface Output Function Number Error 1	There is an undefined number specification in the output signal (OUTM1) function allocation.	<ul style="list-style-type: none"> There is an undefined number specification in the output signal (OUTM1) function allocation. 				○		1576 1577
384A0000 hex	Interface Output Function Number Error 2	There is an undefined number specification in the output signal (OUTM2) function allocation.	<ul style="list-style-type: none"> There is an undefined number specification in the output signal (OUTM2) function allocation. 				○		1576 1577
384B0000 hex	External Latch Input Allocation Error	There is an error in the latch input function allocation.	<ul style="list-style-type: none"> The latch input was allocated to an input signal other than IN5, IN6, or IN7. A latch input is assigned to an NC signal. The same latch input is not assigned to the same pin in all Control Modes. 				○		1576 1577
384C0000 hex	Overrun Limit Error	The Servomotor exceeded the allowable operating range set in the Overrun Limit Setting (3514 hex) with respect to the position command input range.	<ul style="list-style-type: none"> The gain or inertial ratio/mass ratio is not suitable. The set value of the Overrun Limit Setting (3514 hex) is too small. 				○		1576 1577

Event code	Event name	Meaning	Assumed cause	Level					Reference
				M a j	P r t	M i n	O b s	I n f o	
384D0000 hex	Absolute Encoder System Down Error	The voltage of the built-in capacitor dropped below the specified value because the power supply to the encoder or the battery power supply was down.	<ul style="list-style-type: none"> The voltage of the built-in capacitor dropped below the specified value because the power supply to the encoder or the battery power supply was down. 			○			I576
384E0000 hex	Absolute Encoder Counter Overflow Error	The multi-rotation counter of the encoder exceeded the specified value.	<ul style="list-style-type: none"> The set value for switching operation with the absolute encoder is too large. The traveling distance from home of the machine exceeded 32,767 revolutions. 			○			I576
384F0000 hex	Object Setting Error 1	The electronic gear ratio exceeded the allowable range.	<ul style="list-style-type: none"> The electronic gear ratio exceeded the allowable range 			○			I576 I577
38500000 hex	Object Setting Error 2	External encoder ratio exceeded the allowable range.	<ul style="list-style-type: none"> External encoder ratio exceeded the allowable range. 			○			I576 I577
38510000 hex	External Encoder Connection Error	The set value of the External Feedback Pulse Type Selection (3323 hex) differs from the external encoder type that is connected for serial communications.	<ul style="list-style-type: none"> The set value of the External Feedback Pulse Type Selection (3323 hex) differs from the external encoder type that is connected for serial communications. 			○			I576 I577



Event code	Event name	Meaning	Assumed cause	Level					Reference
				M a j	P r t	M i n	O b s	I n f o	
38520000 hex	Function Setting Error	The function that was set does not support the communications period.	<ul style="list-style-type: none"> The electronic gear object ratio was not 1:1 when the communications period was set to 500 μs. Modes of operation (6060 hex) was set to pp or hm when the communications period was set to 500 μs. More than 12 bytes were mapped for RxPDO in Fully-closed Control Mode (This applies only to Cylinder-type Servomotors.). Modes of operation (6060 hex) was set to pp or hm in Fully-closed Control Mode when the communications period was set to 1 ms and the electronic gear parameter ratio was not set to 1:1 (This applies only to Cylinder-type Servomotors.). No bytes (i.e., no objects) were mapped for RxPDO. More than 10 objects were mapped for RxPDO. More than 11 objects were mapped for TxPDO. CSP Switching Reference Position (4020 hex) was mapped for TxPDO when the communications period was set to 500 μs or when the electronic gear object ratio was not set to 1:1. 						1576 1577
38530000 hex	Magnetic Pole Position Estimation Error 1	Magnetic pole position estimation was not completed successfully.	<ul style="list-style-type: none"> Settings associated with the external encoder are incorrect. The command time or force command value for magnetic pole position estimation is too low. There is a large unbalanced load or friction. 					○	1577
38540000 hex	Magnetic Pole Position Estimation Error 2	Magnetic pole position estimation was not completed successfully because the motor did not stop within the Magnetic Pole Position Estimation Time Limit for Stop.	<ul style="list-style-type: none"> The value set for the Magnetic Pole Position Estimation Time Limit for Stop (3927 hex) is small compared with the actual stop time of the motor. The motor is moving when no force is applied. 					○	1577

Event code	Event name	Meaning	Assumed cause	Level					Reference
				M a j	P r t	M i n	O b s	I n f o	
38550000 hex	Magnetic Pole Position Estimation Error 3	Magnetic pole position restoration was not completed successfully.	<ul style="list-style-type: none"> The Magnetic Pole Detection Method (3920 hex) object was set to 3 (Magnetic pole position restoration method), although magnetic pole position estimation had never been executed. The Magnetic Pole Detection Method (3920 hex) was set to 3 (Magnetic pole position restoration method) when a non-absolute type external encoder was used. 			○			I577
38560000 hex	Motor Auto-setting Error	The current exceeded the limit when it was applied to the Motor when the Servo was locked or when FFT measurement preparations were performed.	The Current Loop Proportional Gain or the Current Loop Integral Gain was too large before auto-setting was performed.			○			I577
64E00000 hex	Drive Prohibition Input Error 1	When the Drive Prohibition Input Selection (3504 hex) was set to 0, both the Forward/ Positive Drive Prohibition Input (POT) and Reverse/Negative Drive Prohibition Input (NOT) turned ON. Or, when the Drive Prohibition Input Selection (3504 hex) was set to 2, either the Forward/ Positive Drive Prohibition Input (POT) or Reverse/Negative Drive Prohibition Input (NOT) turned ON.	<ul style="list-style-type: none"> A problem occurred with the switches, wires, and power supplies that are connected to the Forward/Positive Drive Prohibition Input (POT) and Reverse/Negative Drive Prohibition Input (NOT). 			○			I576 I577

Event code	Event name	Meaning	Assumed cause	Level					Reference
				M a j	P r t	M i n	O b s	I n f o	
64E10000 hex	Drive Prohibition Input Error 2	An operation command (such as a trial run of FFT) was received from the CX-Drive when the Drive Prohibition Input Selection (3504 hex) was set to 0, EtherCAT communications was interrupted, and either POT or NOT was ON. Or, POT or NOT turned ON while operation was being performed for a CX-Drive operation command.	<ul style="list-style-type: none"> A problem occurred with the switches, wires, and power supplies that are connected to the Forward/Positive Drive Prohibition Input (POT) and Reverse/Negative Drive Prohibition Input (NOT). 			○			1576 1577
64E20000 hex	Immediate Stop Input Error	An Immediate Stop (STOP) signal was input.	<ul style="list-style-type: none"> An Immediate Stop (STOP) signal was input. Incorrect wiring of the immediate stop input (STOP). 			○			1576 1577



Event code	Event name	Meaning	Assumed cause	Level					Reference
				M a j	P r t	M i n	O b s	I n f o	
74810000 hex	Command Error	A mistake was made in using a command.	<ul style="list-style-type: none"> When bit 09 (Remote) of the Statusword (6041 hex) was set to 1 (remote), and the Servo Drive was in operation enabled state (Servo ON), a command was received that changes the communications state from Operational to another state (Init, Pre-Operational, or Safe-Operational state). When bit 09 (Remote) of the Statusword (6041 hex) was set to 0 (local), a command was received during FFT or test run status that changes the ESM state from Operational, Safe-Operational, or Pre-Operational state to Init state. An unsupported number was set for 6060 hex (Operation Mode). During Fully-closed Control Mode, csv or cst was set for 6060 hex (Operation Mode) (This applies to Cylinder-type Servomotors.). The setting of 6060 hex (Operation Mode) was changed at an interval of less than 2 ms. Homing was started when 6098 hex (Homing Method) was set to a value other than 8, 12, 19, 20, 33, 34, or 35. Data setting warnings (B0 hex) occurred continuously for the number of data setting warnings that is set in 3781 hex (Data Setting Warning Detection Count). 						I576 I577
78010000 hex	Operation Command Competition	An attempt was made to establish EtherCAT communications or to turn ON the Servo from the Controller (enable operation) while executing an FFT that operates with the Servo Drive alone or a trial run.	<ul style="list-style-type: none"> EtherCAT communications (change from Init to Pre-Operational state) was established or an attempt to turn ON the Servo from the Controller (enable operation) was made while executing an FFT that operates with the Servo Drive trial run. 						I576 I577

Event code	Event name	Meaning	Assumed cause	Level					Reference
				M a j	P r t	M i n	O b s	I n f o	
78020000 hex	Absolute Encoder Status Error	The rotation of the encoder was higher than the specified value when the power supply was turned ON.	<ul style="list-style-type: none"> The rotation of the encoder was higher than the specified value when the power supply was turned ON. 			○			1576
84B10000 hex	EtherCAT State Change Error	A communications state change command was received for which the current communications state could not be changed.	<ul style="list-style-type: none"> A communications state change command was received for which the current communications state could not be changed 			○			1576 1577
84B20000 hex	EtherCAT Illegal State Change Error	An undefined communications state change command was received.	<ul style="list-style-type: none"> An undefined communications state change command was received 			○			1576 1577
84B30000 hex	Communications Synchronization Error	The number of consecutive errors in receiving data during the communication sync time exceeded the value specified for the Communications Error Setting (2200 hex).	<ul style="list-style-type: none"> Power to the host controller was interrupted during PDO communications. An EtherCAT communications cable is disconnected, broken, or incorrectly connected. Noise 			○			1576 1577
84B40000 hex	Synchronization Error	A synchronization error occurred.	<ul style="list-style-type: none"> Noise Control PCB error 			○			1576 1577
84B50000 hex	Sync Manager WDT Error	PDO communications were stopped for more than the specified period of time.	<ul style="list-style-type: none"> The EtherCAT communications cable is disconnected or broken. There is an error in the host controller. 			○			1576 1577
84B60000 hex	ESC Initialization Error	An error occurred in ESC initialization.	<ul style="list-style-type: none"> Control PCB error 			○			1576 1577
84B70000 hex	Slave Unit Verification Error	An error occurred in Slave Unit verification.	<ul style="list-style-type: none"> Control PCB error 			○			1576 1577
84B80000 hex	Communications Setting Error	There is an error in the communications settings.	<ul style="list-style-type: none"> An out-of-range value was set from the host controller. A command that changes the communications state to an unsupported state was received. 			○			1576 1577
84B90000 hex	Synchronization Interruption Error	A synchronization interruption error occurred.	<ul style="list-style-type: none"> Control PCB error 			○			1576 1577

Event code	Event name	Meaning	Assumed cause	Level					Reference
				M a j	P r t	M i n	O b s	I n f o	
98010000 hex	Absolute Value Cleared	The multi-rotation counter for the absolute encoder was cleared during USB communications by the CX-Drive.	<ul style="list-style-type: none"> The multi-rotation counter for the absolute encoder was cleared during USB communications by the CX-Drive. 			○			I576
98020000 hex	Position Data Initialized	A Config operation was performed or the multi-rotation counter was cleared for the absolute encoder during EtherCAT communications.	<ul style="list-style-type: none"> A Config operation was performed during EtherCAT communications. The multi-rotation counter was cleared for the absolute encoder. (This applies only to Cylinder-type Servomotors.) 			○			I576 I577
08010000 hex	Battery Warning	The battery voltage is 3.2 V or less.	<ul style="list-style-type: none"> The battery voltage is 3.2 V or lower. 				○		I576
08020000 hex	Fan Warning	The fan stop state continued for 1 second.	<ul style="list-style-type: none"> There is foreign matter in the fan. The Servo Drive failed. 				○		I576 I577
08030000 hex	Encoder Communications Warning	Encoder communications errors occurred in series more frequently than the specified value.	<ul style="list-style-type: none"> There is insufficient power supply voltage for the encoder. Noise is entering on the encoder line. 				○		I576
08040000 hex	Encoder/Serial Conversion Unit Overheating Warning	The encoder temperature exceeded the specified value or an overheating warning was detected for the Serial Conversion Unit.	<ul style="list-style-type: none"> The ambient temperature is too high. Servomotor/Linear Motor failed. 				○		I576 I577
08050000 hex	Life Expectancy Warning	The remaining life of the capacitor or the fan is shorter than the specified value.	<ul style="list-style-type: none"> The life expectancy of the capacitor or the fan is shorter than the specified value. 				○		I576 I577
08060000 hex	External Encoder Error Warning	The external encoder detected a warning.	<ul style="list-style-type: none"> There is insufficient power supply voltage for the external encoder. Noise is entering on the external encoder connector cable. The external encoder failed. 				○		I576 I577
08070000 hex	External Encoder Communications Warning	The external encoder had more communications errors than the specified value.	<ul style="list-style-type: none"> There is insufficient power supply voltage for the external encoder. Noise is entering on the external encoder connector cable. 				○		I576 I577
34E00000 hex	Data Setting Warning	An object setting is out of range.	<ul style="list-style-type: none"> The object set value is out of the range 				○		I576 I577
383C0000 hex	Overload Warning	The load ratio is 85% or more of the protection level.	<ul style="list-style-type: none"> Overload There is incorrect wiring of the motor line or a broken cable. 				○		I576 I577

Event code	Event name	Meaning	Assumed cause	Level					Reference
				M a j	P r t	M i n	O b s	I n f o	
383D0000 hex	Excessive Regeneration Warning	The regeneration load ratio is 85% or more of the level.	<ul style="list-style-type: none"> There is excessive regeneration. This Regeneration Resistor cannot be used for continuous regenerative braking. 				○		1576 1577
383E0000 hex	Vibration Detection Warning	Vibration was detected.	<ul style="list-style-type: none"> The gain or inertial ratio/mass ratio setting is not suitable. 				○		1576 1577
74800000 hex	Command Warning	A command could not be executed.	<ul style="list-style-type: none"> The absolute multi-rotation counter was cleared when the Servo was not OFF when using an absolute encoder for semi-closed control (This applies only to Cylinder-type Servomotors.). A forced brake operation request was sent while the Servo was ON. A Switch ON command was sent when the main power was OFF. (When 3508 hex = 0) An Enable Operation command was sent to request turning ON the Servo when the Servomotor was operating at 30 r/min or 30 mm/s, or higher. A latch operation was started under the following conditions. An absolute external encoder was used and phase Z was selected as the trigger for fully-closed control (This applies only to Cylinder-type Servomotors.). The absolute multi-rotation data was being cleared or the Config operation was being performed. The Statusword (6041 hex) bit 09 (remote) was 0 (local). An operation command is given in the prohibited direction after the motor made an immediate stop due to a drive prohibition input. 				○		1576 1577
84B00000 hex	EtherCAT Communications Warning	An EtherCAT communications error occurred one or more times.	<ul style="list-style-type: none"> The EtherCAT communications cable is disconnected or broken. Noise 				○		1576 1577

MX2/RX-series Inverters with EtherCAT Communications Units

The manual names are given below for the catalog numbers given in the Reference column of the event table.

Cat. No.	Manual name
I574	MX2/RX Series Inverter EtherCAT Communication Unit User's Manual

Event code	Event name	Meaning	Assumed cause	Level					Reference
				M a j	P r t	M i n	O b s	I n f o	
04A10000 hex	Non-volatile Memory Hardware Error	An error occurred in non-volatile memory.	<ul style="list-style-type: none"> Non-volatile memory failure Noise 			○			I574 W640
04BA0000 hex	Connection Error between Inverter and Communications Unit	An error occurred in the connection between the Inverter and the EtherCAT Communications Unit for the Inverter.	<ul style="list-style-type: none"> Contact failure between the Inverter and the EtherCAT Communications Unit for the Inverter. Inverter trip was reset. The Inverter was initialized or the mode was changed. The EtherCAT Communications Unit for the Inverter failed. 			○			I574
04BB0000 hex	Inverter Warning	An Inverter warning was detected.	<ul style="list-style-type: none"> An Inverter warning was detected. 			○			I574
04BC0000 hex	Inverter Trip	An Inverter trip was detected.	<ul style="list-style-type: none"> An Inverter trip was detected. 			○			I574
34F00000 hex	PDO Setting Error	There is an illegal setting value in the PDO mapping.	<ul style="list-style-type: none"> The PDO mapping or SyncManager settings are incorrect. 			○			I574

FH/FZ5 Series Vision System

The manual names are given below for the catalog numbers given in the Reference column of the event table.

Cat. No.	Manual name
Z342	FH/FZ5 Vision System FH/FZ5 Series User's Manual for Communications Settings

Event code	Event name	Meaning	Assumed cause	Level					Reference
				M a j	P r t	M i n	O b s	I n f o	
08210000 hex	Fan/Power Supply Error	An error occurred in the fan or power supply.	<ul style="list-style-type: none"> A foreign object is interfering with fan operation. A suitable power supply voltage is not being used, resulting in an overvoltage or under-voltage. 						Z342
08220000 hex	Camera Overcurrent Detected	An overcurrent flowed to the Camera.	<ul style="list-style-type: none"> There is a short circuit inside the Camera cable or in a circuit inside the Controller. 						Z342
08230000 hex	Parallel I/O Overcurrent Detected	An overcurrent occurred in the parallel I/O interface.	<ul style="list-style-type: none"> A parallel I/O interface line is short-circuited. 						Z342
182D0000 hex	Setting Data Load Error	Loading the scene group data failed.	<ul style="list-style-type: none"> The data is corrupted because the power supply was turned OFF while saving the previous scene data. As the result of changing the operation mode, the required amount of memory increased, resulting in insufficient memory. 						Z342
38590000 hex	Camera Connection Error	The Camera connection is wrong.	<ul style="list-style-type: none"> A Camera is not connected to the Controller. The Camera cable is broken. The Camera Selection settings are not correct in the Camera Image Input and Camera Switching processing items. A Camera is not connected to the Camera port on the Controller according to the Camera Selection settings in the Camera Image Input and Camera Switching processing items. 						Z342
385A0000 hex	Change in Connected Camera	The Camera that is connected is different from when data was last saved.	<ul style="list-style-type: none"> The Camera connection information in the scene data does not agree with the connection information for the Camera connected to the Controller. 						Z342

Event code	Event name	Meaning	Assumed cause	Level					Reference
				M a j	P r t	M i n	O b s	I n f o	
385B0000 hex	Light installation error	The Light installation is incorrect.	<ul style="list-style-type: none"> The power consumption of the light installed onto a camera with a Lighting Controller is incorrect. The lighting mode of the light installed onto a camera with a Lighting Controller is incorrect. No external power supply is connected to the camera with a Lighting Controller. 			○			Z342
48020000 hex	System Error	An error occurred in the system.	<ul style="list-style-type: none"> A serious error occurred in the system in the Controller. 			○			Z342
58210000 hex	Output Control Timeout for Parallel I/O, PLC Link, or EtherNet/ IP	A timeout occurred in data output handshaking control for measurement results.	<ul style="list-style-type: none"> The data output handshaking controls in the program (i.e., the ON/OFF timing of the DSA signal) are not correct. The output control timeout time is too short in comparison with the program processing time. The parallel I/O DSA or Result Notification signal is not wired correctly. 			○			Z342
58220000 hex	Output Control Timeout for EtherCAT	A timeout occurred in data output handshaking control for measurement results.	<ul style="list-style-type: none"> The data output handshaking controls in the program (i.e., the ON/OFF timing of the Result Set Request signal) are not correct. The output control timeout time is too short in comparison with the program processing time. 			○			Z342
58230000 hex	Initial scene group error	Initial scene group setting is incorrect.	<ul style="list-style-type: none"> The external storage specified as the scene group destination by the Scene Group Saving Destination Settings tool is not connected at the time of start-up. The destination directory is not detected at the time of startup. Initial scene group number is not within the range of scene group accepted by the system. 			○			Z342
58240000 hex	Initial scene number error	Initial scene number setting is incorrect.	<ul style="list-style-type: none"> Initial scene number is not within the range of scenes accepted by the system. 			○			Z342
78190000 hex	Image Logging Disk Write Error	Writing data to the image logging disk failed.	<ul style="list-style-type: none"> A logging disk is not inserted. The available space on the logging disk is not sufficient. There is no logging folder. Security restrictions are set on the logging disk. 			○			Z342

Event code	Event name	Meaning	Assumed cause	Level					Reference
				M a j	P r t	M i n	O b s	I n f o	
781A0000 hex	Setting Data Transfer Error	An error occurred while transferring the scene data.	<ul style="list-style-type: none"> Scene data was edited when there was little available space on the RAM disk and the operation mode was Double Speed Multiinput. The data transfer button was clicked when there was little available space on the RAM disk and the operation mode was Non-stop Adjustment Mode. 			○			Z342
781B0000 hex	Output Buffer Error (EtherCAT)	The data output buffer for measurement data is full.	<ul style="list-style-type: none"> Data measurements are being performed on a period that is shorter than the time that is required for data output handshake controls in the program. 			○			Z342
88080000 hex	PLC Link Communications Error	A PLC Link cannot be established.	<ul style="list-style-type: none"> There is a mistake in the PLC or Vision Sensor communications settings. The Ethernet or RS-232C cable is damaged. 			○			Z342



EtherCAT FQ-M-series Specialized Vision Sensors for Positioning

The manual names are given below for the catalog numbers given in the Reference column of the event table.

Cat. No.	Manual name
Z314	FQ-M-series Specialized Vision Sensor for Positioning User's Manual

Event code	Event name	Meaning	Assumed cause	Level					Reference
				M a j	P r t	M i n	O b s	I n f o	
78080000 hex	TRIG Input Error	A TRIG signal was input when the BUSY signal for Sensor measurement was ON.	<ul style="list-style-type: none"> A TRIG signal was input when the BUSY signal for Sensor measurement was ON. Chattering occurred for a contact input. 			○			Z314
780A0000 hex	Scene Data Error	The scene data to switch to is corrupted.	<ul style="list-style-type: none"> The power supply was interrupted when the scene data to switch to was saved. 			○			Z314
780B0000 hex	Model Error	A model was re-registered with an image with low contrast.	<ul style="list-style-type: none"> A model was re-registered with an image with low contrast. 			○			Z314
780C0000 hex	Logging Error	Some data was not saved when logging data to files on an SD card.	<ul style="list-style-type: none"> Too much data to log in files occurred in a short period of time, and writing to the SD card could not keep up. 			○			Z314
780D0000 hex	Output Timeout	A timeout occurred in data output handshaking control for measurement results.	<ul style="list-style-type: none"> The data output handshaking controls in the program (i.e., the ON/OFF timing of the DSA signal) are not correct. The output control timeout time is too short in comparison with the program processing time. 			○			Z314
780E0000 hex	Output Size Error	The data output size setting and the PDO mapping setting do not agree.	<ul style="list-style-type: none"> The EtherCAT data output size setting in the Sensor and the PDO mapping setting in the EtherCAT master do not agree. 			○			Z314

E3X-series Fiber Sensors with EtherCAT Communications Unit for Digital Sensors

The manual names are given below for the catalog numbers given in the Reference column of the event table.

Cat. No.	Manual name
E413	EtherCAT Digital-type Sensor Communication Unit Operation Manual

Event code	Event name	Meaning	Assumed cause	Level					Reference
				M a j	P r t	M i n	O b s	I n f o	
04C40000 hex	Sensor Communications Error	An error occurred in a Sensor connection.	<ul style="list-style-type: none"> The Sensor is disconnected. 			○			E413
04C50000 hex	Sensor Communications Has Not Been Established	Communications has not been established with the Sensor.	<ul style="list-style-type: none"> A Sensor is not connected. 			○			E413
14A00000 hex	Non-volatile Memory Checksum Error	An error occurred in the control parameters.	<ul style="list-style-type: none"> Noise 			○			E413 W640
24780000 hex	Number of Sensors Verify Error	The number of Sensors that is connected does not agree with the settings.	<ul style="list-style-type: none"> The set value does not match the number of Sensors that are actually connected. 			○			E413
24790000 hex	Number of Sensors Over Limit	Too many Sensors are connected.	<ul style="list-style-type: none"> More than the maximum number of Sensors are connected. 			○			E413
34F80000 hex	Dummy Sensors Setting Error	Too many Dummy Units are set.	<ul style="list-style-type: none"> There are too many Dummy Units set, so some Sensors are not assigned logical unit numbers. 			○			E413
04A10000 hex	Non-volatile Memory Hardware Error	An error occurred in non-volatile memory.	<ul style="list-style-type: none"> Non-volatile memory failure Noise 				○		E413 W640

A

E3NW-ECT EtherCAT Digital Sensor Communications Unit

The manual names are given below for the catalog numbers given in the Reference column of the event table.

Cat. No.	Manual name
E429	EtherCAT Digital-type Sensor Communication Unit Operation Manual

Event code	Event name	Meaning	Assumed cause	Level					Reference
				M a j	P r t	M i n	O b s	I n f o	
04C40000 hex	Sensor Communications Error	An error occurred in a Sensor connection.	<ul style="list-style-type: none"> The Sensor is disconnected. 				○		E429
04C50000 hex	Sensor Communications Has Not Been Established	Communications has not been established with the Sensor.	<ul style="list-style-type: none"> A sensor is not connected. 				○		E429
14A00000 hex	Non-volatile Memory Checksum Error	An error occurred in the control parameters.	<ul style="list-style-type: none"> Noise 				○		E429 W640
247A 0000 hex	Number of Distributed Sensor Unit Verify Error	The number of Distributed Sensor Unit that is checked at power up is decreased.	<ul style="list-style-type: none"> The Distributed Sensor Unit is disconnected 				○		E429
247B 0000 hex	Number of Sensors Over Limit	Too many Sensors are connected.	<ul style="list-style-type: none"> More than the maximum number of Sensors are connected. 				○		E429
247C 0000 hex	Number of Sensors Verify Error	The number of Sensors that is connected does not agree with the settings.	<ul style="list-style-type: none"> The set value does not match the number of Sensors that are actually connected. 				○		E429
247D 0000 hex	Number of Sensors Over at Distributed Sensor Unit	Too many Sensors are connected at Distributed Sensor Unit.	<ul style="list-style-type: none"> More than the maximum number of Sensors are connected at Distributed Sensor Unit. 				○		E429
34F80000 hex	Dummy Sensors Setting Error	Too many Dummy Units are set.	<ul style="list-style-type: none"> There are too many Dummy Units set, so some Sensors are not assigned logical unit numbers. 				○		E429
04A10000 hex	Non-volatile Memory Hardware Error	An error occurred in non-volatile memory.	<ul style="list-style-type: none"> Non-volatile memory failure Noise 				○		E429 W640

ZW-CE1□T Confocal Fiber Type Displacement Sensor

The manual names are given below for the catalog numbers given in the Reference column of the event table.

Cat. No.	Manual name
Z332	ZW-CE1□T Confocal Fiber Type Displacement Sensor User's Manual

Event code	Event name	Meaning	Assumed cause	Level					Reference	
				M a j	P r t	M i n	O b s	I n f o		
04D00000 hex	Hardware error	Some abnormality occurred on the displacement sensor hardware.	<ul style="list-style-type: none"> Hardware damage 					○		Z332
14B00000 hex	Linearity correction data error	The linearity correction data of the displacement sensor is damaged.	<ul style="list-style-type: none"> Calibration ROM damage 					○		Z332
14B10000 hex	Linearity correction data read error	Reading of the displacement sensor linearity correction data was not executed correctly.	<ul style="list-style-type: none"> Calibration ROM not inserted Calibration ROM damage 					○		Z332
14B20000 hex	System setting error	The system settings saved to the displacement sensor are corrupt.	<ul style="list-style-type: none"> The displacement sensor power was turned OFF during saving/loading of system settings. 					○		Z332
14B30000 hex	Bank data error	The bank data saved to the displacement sensor is corrupt.	<ul style="list-style-type: none"> The displacement sensor power was turned OFF during saving/loading of bank data. 					○		Z332
24810000 hex	Ethernet communication parameter error	An invalid IP address is set for the displacement sensor.	<ul style="list-style-type: none"> Invalid IP address setting 					○		Z332
74900000 hex	Multiple control signal input error	Multiple control signals turned ON in the same cycle.	<ul style="list-style-type: none"> Multiple control signals turned ON in the same cycle. 					○		Z332
74910000 hex	EXE input error	EXE input processing was not executed correctly.	<ul style="list-style-type: none"> EXE input turned ON in the FUN mode. EXE input turned ON with READY output OFF. 					○		Z332
74920000 hex	SYNC input error	SYNC input processing was not executed correctly.	<ul style="list-style-type: none"> SYNC input turned ON in the FUN mode. 					○		Z332

Event code	Event name	Meaning	Assumed cause	Level					Reference
				M a j	P r t	M i n	O b s	I n f o	
74930000 hex	TIMING input error	TIMING input processing was not executed correctly.	<ul style="list-style-type: none"> TIMINGx input turned ON in the FUN mode. TIMINGx input turned ON or OFF while RESETx input was ON. TIMINGx input turned ON in a non-measurement state. TIMINGx input turned ON before the "delay time + sampling time" elapsed. 			○			Z332
74940000 hex	RESET input error	RESET input processing was not executed correctly.	<ul style="list-style-type: none"> RESETx input turned ON in the FUN mode. 			○			Z332
74950000 hex	ZERO input error	ZERO input processing was not executed correctly.	<ul style="list-style-type: none"> ZEROx input turned ON in the FUN mode. ZEROx input turned ON in a non-measurement state. ZEROx input turned ON for a task whose status is OFF. 			○			Z332
74960000 hex	ZEROCLR input error	ZEROCLR input processing was not executed correctly.	<ul style="list-style-type: none"> ZEROCLRx input turned ON in the FUN mode. 			○			Z332

A-2-3 Errors in CJ-series Units

The section provides tables of the errors (events) that can occur in the following CJ-series Units.

- Analog I/O Units
- Process I/O Units
- Temperature Control Units
- ID Sensor Units
- High-speed Counter Units
- Serial Communications Units
- DeviceNet Units
- EtherNet/IP Units
- CompoNet Master Units
- EtherCAT Slave Units

CJ-series Analog I/O Units

The section provides tables of the errors (events) that can occur in the following Units.

CJ1W-AD041-V1/AD081-V1

CJ1W-AD042

CJ1W-DA021/DA041

CJ1W-DA08V/DA08C

CJ1W-DA042V

CJ1W-MAD42

The manual names are given below for the catalog numbers given in the Reference column of the event table.

Cat. No.	Manual name
W490	CJ-series Analog I/O Units Operation Manual for NJ-series CPU Unit

Event code	Event name	Meaning	Assumed cause	Level					Reference
				M a j	P r t	M i n	O b s	I n f o	
04600000 hex	A/D Conversion Error	An error occurred in A/D conversion.	<ul style="list-style-type: none"> • There is a source of noise nearby. • A/D converter failed. 			○	◐		W490
04620000 hex	Non-volatile Memory Error	An error occurred in non-volatile memory.	<ul style="list-style-type: none"> • There is a source of noise nearby. • Non-volatile memory failed. 			○			W490
34800000 hex	Mean Value Processing Setting Error	There is a mistake in the setting of the number of samplings for mean value processing.	<ul style="list-style-type: none"> • There is a mistake in the setting of the number of samplings for mean value processing. 			○			W490

Event code	Event name	Meaning	Assumed cause	Level					Reference
				M a j	P r t	M i n	O b s	I n f o	
34830000 hex	Scaling Data Setting Error	There is a mistake in the scaling data settings.	<ul style="list-style-type: none"> The upper or lower limit data for scaling is outside the setting range. Or, the maximum value and minimum value are not 0 and they are the same. 			○			W490
34840000 hex	Input Signal Range Setting Error or Error in Number of Inputs Setting	There is a mistake in the input signal range setting or in the number of inputs setting.	<ul style="list-style-type: none"> The settings of the input signal range or the setting of the number of analog inputs that are used is incorrect. 			○			W490
34850000 hex	Mean Value Processing Setting Error	There is a mistake in the setting of the number of samplings for mean value processing.	<ul style="list-style-type: none"> There is a mistake in the setting of the number of samplings for mean value processing. 			○			W490
34860000 hex	Error in Setting of Conversion Mode	There is a mistake is the Conversion Mode setting.	<ul style="list-style-type: none"> The specification of the Cyclic Conversion Mode or Direct Conversion Mode is not correct. 			○			W490
34870000 hex	Output Hold Setting Error	There is a mistake in the output hold setting.	<ul style="list-style-type: none"> The setting for output status when conversion stops is incorrect. 			○			W490
34890000 hex	Conversion Time/Resolution or Operation Mode Setting Error	There is a mistake in the conversion time/resolution or operation mode setting.	<ul style="list-style-type: none"> There is a mistake in the conversion time/resolution or operation mode setting. 			○			W490
348A0000 hex	Output Signal Range Setting Error or Error In Number of Outputs Used Setting	There is a mistake in the output signal range setting or in the number of outputs setting.	<ul style="list-style-type: none"> There is a mistake in the output signal range setting or in the number of outputs setting. 			○			W490
38010000 hex	Scaling Data Setting Error/Ratio Conversion Use Setting Error	There is an error in the scaling data setting or ratio conversion use setting.	<ul style="list-style-type: none"> The upper or lower limit data for scaling is outside the setting range. Or, the maximum value and minimum value are not 0 and they are the same. The I/O number for ratio conversion is set to Not used in the I/O specifications. 			○			W490
38020000 hex	Ratio Set Value Error	There is a mistake is the ratio setting for ratio conversion.	<ul style="list-style-type: none"> A value other than 16#0000 to 16#9999 (0.00 to 99.99) was specified for the ratio conversion A constant for ratio conversion. 			○			W490



Event code	Event name	Meaning	Assumed cause	Level					Reference
				M a j	P r t	M i n	O b s	I n f o	
64780000 hex	Input Disconnection Detected	The input is disconnected.	<ul style="list-style-type: none"> Input wiring is broken. Input wiring disconnection 			○	○		W490
64790000 hex	Output Set Value Error	The output setting is out of range.	<ul style="list-style-type: none"> An output set value setting is out of range. 			○	○		W490
34810000 hex	Input Value Exceeded Adjustment Range in Adjustment Mode	In Adjustment Mode, the input value exceeded the range for which adjustment is possible.	<ul style="list-style-type: none"> In Adjustment Mode, the input value exceeded the range for which adjustment is possible, so the offset and gain cannot be adjusted. 			○	○		W490
34820000 hex	Input Number Specification Error in Adjustment Mode	The input number specified in Adjustment Mode is not enabled or the input number is wrong.	<ul style="list-style-type: none"> The input number that was specified in Adjustment Mode is not enabled. The setting of the Adjustment Input Number (device variable *_AdjCh) is incorrect, so adjustment is not possible. 			○	○		W490
34880000 hex	Output Number Specification Error in Adjustment Mode	The output number specified in Adjustment Mode is not enabled or the output number is wrong.	<ul style="list-style-type: none"> The output number that was specified in Adjustment Mode is not enabled. The setting of the Adjustment Output Number (device variable *_AdjCh) is incorrect, so adjustment is not possible. 			○	○		W490
348C0000 hex	I/O Number Specification Error in Adjustment Mode	The I/O numbers specified in Adjustment Mode are not enabled or the I/O numbers are wrong.	<ul style="list-style-type: none"> The I/O numbers that were specified in Adjustment Mode are not enabled. The setting of the Adjustment I/O Number (device variable *_AdjCh) is incorrect, so adjustment is not possible. 			○	○		W490

CJ-series Process I/O Units

The section provides tables of the errors (events) that can occur in the following Units.

CJ1W-PDC15

CJ1W-AD04U

CJ1W-PH41U

The manual names are given below for the catalog numbers given in the Reference column of the event table.

Cat. No.	Manual name
W498	CJ-series Analog I/O Units Operation Manual for NJ-series CPU Unit

Event code	Event name	Meaning	Assumed cause	Level					Reference
				M a j	P r t	M i n	O b s	I n f o	
04600000 hex	A/D Conversion Error	An error occurred in A/D conversion.	<ul style="list-style-type: none"> There is a source of noise nearby. A/D converter failed. 			○	⊙		W498
04610000 hex	Cold Junction Sensor Error	An error occurred in the cold junction sensor.	<ul style="list-style-type: none"> Faulty connection to the cold junction sensor for the CJ1W-PH41U. The cold junction sensor failed. 			○	⊙		W498
04620000 hex	Non-volatile Memory Error	An error occurred in non-volatile memory.	<ul style="list-style-type: none"> There is a source of noise nearby. Non-volatile memory failed. 			○			W498
348D0000 hex	Data Range Error	A set value is out of range.	<ul style="list-style-type: none"> A set value is out of range. 			○			W498
647A0000 hex	Input Error	An input error occurred.	<ul style="list-style-type: none"> The analog input signal is out of range. Input wiring is broken. Input wiring disconnection or loose terminal 			○	⊙		W498
647D0000 hex	Zero/Span Adjustment Period End	The zero/span adjustment period expired.	<ul style="list-style-type: none"> The zero/span adjustment period expired. 			⊙	○		W498
647E0000 hex	Zero/Span Adjustment Period Notice	The zero/span adjustment period is close to expiring.	<ul style="list-style-type: none"> The notification period for the expiration of zero/span adjustment occurred. 			⊙	○		W498

CJ-series Temperature Control Units

The section provides tables of the errors (events) that can occur in the following Units.

CJ1W-TC003

CJ1W-TC004

CJ1W-TC103

CJ1W-TC104

The manual names are given below for the catalog numbers given in the Reference column of the event table.

Cat. No.	Manual name
W491	CJ-series Temperature Control Units Operation Manual for NJ-series CPU Unit

Event code	Event name	Meaning	Assumed cause	Level					Reference
				M a j	P r t	M i n	O b s	I n f o	
04680000 hex	Cold Junction Sensor Error	An error occurred in the cold junction sensor.	<ul style="list-style-type: none"> Faulty connection to the cold junction sensor. The cold junction sensor failed. 			⊙	○		W491
34940000 hex	Setting Error	There is an illegal setting.	<ul style="list-style-type: none"> The set value is incorrect. 			⊙	○		W491
64840000 hex	Sensor Error	An error occurred in the sensor input.	<ul style="list-style-type: none"> Error in input from the Sensor. 			⊙	○		W491
64850000 hex	CT Overflow	An overflow occurred in the CT input.	<ul style="list-style-type: none"> The heater current exceeded 55.0 A. 			⊙	○		W491
64860000 hex	Heater Burnout Alarm	A heater burnout occurred.	<ul style="list-style-type: none"> The power supply to the heater is not ON. The heater is burned out or deteriorated. 			⊙	○		W491

A

CJ-series ID Sensor Units

The section provides tables of the errors (events) that can occur in the following Units.

CJ1W-V680C11

CJ1W-V680C12

The manual names are given below for the catalog numbers given in the Reference column of the event table.

Cat. No.	Manual name
Z317	CJ-series ID Sensor Units Operation Manual for NJ-series CPU Unit

Event code	Event name	Meaning	Assumed cause	Level					Reference
				M a j	P r t	M i n	O b s	I n f o	
046C0000 hex	Unit Status, Antenna Power Supply Error	An error occurred in the power supply to the Antenna.	<ul style="list-style-type: none"> An error occurred in the power supply (24 V) to the Antenna. 			○			Z317
046D0000 hex	Unit Status, Memory Error	An error occurred when reading non-volatile memory.	<ul style="list-style-type: none"> There is a source of noise nearby. Non-volatile memory failure 			○			Z317
046E0000 hex	Results Information, Antenna Error	An error occurred in the Antenna.	<ul style="list-style-type: none"> The Antenna is not connected. Antenna failure The ID Sensor Unit failed. 			○			Z317
046F0000 hex	Unit Status, Unit Busy	An error occurred in an ID Sensor Unit.	<ul style="list-style-type: none"> There is a source of noise nearby. The ID Sensor Unit failed. 			○			Z317
24400000 hex	Unit Status, Antenna Error	An error occurred in the Antenna.	<ul style="list-style-type: none"> The setting of the Connected Antenna Setting (device variable *_Ch#_AntConn) does not agree with the Antenna that is connected. The V680-H01 or V680-H01-V2 was connected to the CJ1WV680C12. 			○			Z317
34980000 hex	Results Information, Data Storage Area Specification Error	The data storage area specification is not correct.	<ul style="list-style-type: none"> The user program specifies addresses in the DM, CIO, AR, EM, or other areas that exceed the ranges defined for the data storage area specifications. 			○			Z317
54A00000 hex	Results Information, ID Tag Address Error	The address of the ID Tag is wrong.	<ul style="list-style-type: none"> The address of an ID Tag specified in a command is incorrect. 			○			Z317

Event code	Event name	Meaning	Assumed cause	Level					Reference
				M a j	P r t	M i n	O b s	I n f o	
54A10000 hex	Results Information, Write Protection Error	An attempt was made to write to a write-protected area of the ID Tag.	<ul style="list-style-type: none"> The specified address or number of bytes is incorrect. Write-protection is enabled for the area you attempted to write to in the ID Tag. 			○			Z317
54A20000 hex	Results Information, Command Error	The command to the ID Sensor Unit is not correct.	<ul style="list-style-type: none"> The contents of the following external device variables is not data that can be specified (where # is the channel number). <ul style="list-style-type: none"> *_Ch#_CmdSet *_Ch#_ProcAdr *_Ch#_ProcByte *_Ch#_CmdOption "#" in the variable name is the Antenna (Head) number. 			○			Z317
648C0000 hex	Unit Status, Command Error End	A processing error occurred.	<ul style="list-style-type: none"> A processing error occurred. 			○			Z317
648D0000 hex	Results Information, Verification Error	The correct data could not be written to the ID Tag.	<ul style="list-style-type: none"> The travel speed of the ID Tag is outside the specified range. The distance between the Antenna and ID Tag is outside the specified range. Noise 			○			Z317
648E0000 hex	Results Information, ID Tag Communications Error	An error occurred in communications with an ID Tag, preventing a normal end.	<ul style="list-style-type: none"> The travel speed of the ID Tag is outside the specified range. The distance between the Antenna and ID Tag is outside the specified range. Noise 			○			Z317
648F0000 hex	Results Information, ID Tag Missing Error	There is no ID Tag in the communications area.	<ul style="list-style-type: none"> The communications specification is set to trigger, and the ID Tag is not in the communications area when the trigger occurs. The communications specification is set to single auto or repeat auto, and the wait time reached the Auto Wait Time. An Amplifier is connected, but an Antenna is not connected. 			○			Z317
64900000 hex	Results Information, ID System Error 1	ID system error 1 occurred.	<ul style="list-style-type: none"> System error 1 occurred. 			○			Z317
64910000 hex	Results Information, ID System Error 2	ID system error 2 occurred.	<ul style="list-style-type: none"> System error 2 occurred. 			○			Z317

Event code	Event name	Meaning	Assumed cause	Level					Reference
				M a j	P r t	M i n	O b s	I n f o	
64920000 hex	Results Information, ID System Error 3	ID system error 3 occurred.	<ul style="list-style-type: none"> System error 3 occurred. 			○			Z317
64930000 hex	Results Information, ID Tag Status	One of the following occurred. <ul style="list-style-type: none"> The number of writes was exceeded for a Number of Writes Control command. An overflow or underflow occurred for a Calculation Write command. The data did not verify for a Data Check command. An error occurred in the data for a Read with Error Correction command. An error occurred when writing for a Copy command. 	<ul style="list-style-type: none"> The number of writes was exceeded for a Number of Writes Control command. An overflow or underflow occurred for a Calculation Write command. The data did not verify for a Data Check command. An error occurred in the data for a Read with Error Correction command. An error occurred when writing for a Copy command. 			○			Z317
64940000 hex	Results Information, Error Correction	A Write with Error Correction command performed a 1-bit error correction.	<ul style="list-style-type: none"> There is ambient noise where the ID Tag is used. ID Tag error. 			○			Z317

CJ-series High-speed Counter Units

The section provides tables of the errors (events) that can occur in the following Units.
CJ1W-CT021

The manual names are given below for the catalog numbers given in the Reference column of the event table.

Cat. No.	Manual name
W492	CJ-series High-speed Counter Units Operation Manual for NJ-series CPU Unit

Event code	Event name	Meaning	Assumed cause	Level					Reference
				M a j	P r t	M i n	O b s	I n f o	
68010000 hex	Unit Error	An error occurred in the High-speed Counter Unit.	<ul style="list-style-type: none"> There is an error in the Special Unit Setup. An overflow or underflow error occurred. An illegal preset value was used. A CPU Unit monitor error or bus error occurred. The start delay time at startup was set to more than 10 seconds for the the CPU Unit. 			○			W492

CJ-series Serial Communications Units

The section provides tables of the errors (events) that can occur in the following Units.

CJ1W-SCU22

CJ1W-SCU32

CJ1W-SCU42

The manual names are given below for the catalog numbers given in the Reference column of the event table.

Cat. No.	Manual name
W494	CJ-series Serial Communications Units Operation Manual for NJ-series CPU Unit

Event code	Event name	Meaning	Assumed cause	Level					Reference
				M a j	P r t	M i n	O b s	I n f o	
04740000 hex	Error Log Data Error	An error occurred in the error log data.	<ul style="list-style-type: none"> There is a source of noise nearby. Non-volatile memory failure 				○		W494
14800000 hex	Protocol Data Error	A protocol data checksum error has occurred.	<ul style="list-style-type: none"> The communications connector with the CX-Protocol was disconnected or the power supply to the Controller was interrupted during transfer of the protocol data from the CX-Protocol. The Serial Communications Unit failed. 				○		W494
34A40000 hex	System Setup Error	There is an error in the system settings for the Serial Communications Unit.	<ul style="list-style-type: none"> There is an error in the system settings for the Serial Communications Unit. 				○		W494
04750000 hex	DTR Check Error	An error was found during the DTR check.	<ul style="list-style-type: none"> Loopback test jig failure. Noise The communications circuits in the Serial Communications Unit are faulty. 					○	W494
04760000 hex	CTS Check Error	An error was found during the CTS check.	<ul style="list-style-type: none"> Loopback test jig failure. Noise The communications circuits in the Serial Communications Unit are faulty. 					○	W494
54A80000 hex	Command Error	A command error occurred.	<ul style="list-style-type: none"> The constant in the expected receive message that is set in the protocol macro is different from the constant in the message that was received. 					○	W494



Event code	Event name	Meaning	Assumed cause	Level					Reference
				M a j	P r t	M i n	O b s	I n f o	
54A90000 hex	Sequence Abort Completed	The sequence was ended by an Abort setting for the next processing or error processing.	<ul style="list-style-type: none"> The protocol macro data is not set correctly. The baud rate, frame format, or other system setting does not agree with the remote node. 				○		W494
54AA0000 hex	Protocol Macro Error	An error occurred in the protocol macro.	<ul style="list-style-type: none"> Sequence No. Error: An unregistered number was specified for SeqNo (communications sequence number) of the ExecPMCR instruction (no indicators light). Data read/write area exceeded error: The specified area range was exceeded when data was written to or read from the CPU Unit. (The ERC indicator and ERR/ALM indicator will flash.) Protocol data syntax error: There was a code that cannot be executed during protocol execution. (The ERC indicator and ERR/ALM indicator will flash.) <ul style="list-style-type: none"> The total of the areas specified for link words O1, O2, I1, and I2 exceeded 500 words. The same link word is used by both ports 1 and 2. Writing was specified with a constant. Interrupt notification was specified for a Serial Communications Unit. Thirty one or more items were set for the write attribute data for one message. A length of 0 bytes was specified for a message that was sent or received. The length of a message to be sent or received exceeds the maximum send/receive bytes. A message is not registered for matrix reception. The transmission control is set to both RTS/CTS flow control and Xon/Xoff flow control. 				○		W494

Event code	Event name	Meaning	Assumed cause	Level					Reference
				M a j	P r t	M i n	O b s	I n f o	
64A00000 hex	Tfs (Send Finished Monitoring Time) Exceeded	The time required to complete a send operation exceeded the Send Finished Monitoring Time.	<ul style="list-style-type: none"> Noise The monitoring time is shorter than the actual completion time. 				○		W494
64A10000 hex	Tfr (Receive Finished Monitoring Time) Exceeded	The time required to complete a reception operation exceeded the Receive Finished Monitoring Time.	<ul style="list-style-type: none"> Noise The monitoring time is shorter than the actual completion time. 				○		W494
64A20000 hex	Tr (Receive Wait Monitoring Time) Exceeded	The receive waiting time exceeded the Receive Wait Monitoring Time.	<ul style="list-style-type: none"> Noise The monitoring time is shorter than the actual completion time. 				○		W494
64A30000 hex	FCS Check Error	<p>One of the following errors occurred in the converted protocol at the serial gateway.</p> <ul style="list-style-type: none"> When converting to CompoWay/F command: BCC error When converting to Modbus-RTU command: CRC error When converting to Modbus-ASCII command: CRC error When converting to Host Link FINS command: FCS error <p>Protocol Macros</p> <ul style="list-style-type: none"> The check code attached to the received message does not match the check code that was calculated from the received message. 	<ul style="list-style-type: none"> Noise There was a mistake in the CRC code that was attached to the command frame. 				○		W494



Event code	Event name	Meaning	Assumed cause	Level					Reference
				M a j	P r t	M i n	O b s	I n f o	
64A40000 hex	Timeout Error	A timeout error occurred.	<ul style="list-style-type: none"> The steps in the communications sequence of a protocol macro are not progressing. There is no remote device to receive the command. The command frame is incorrect. The remote device is not using the same serial communications settings. Wiring is not correct or terminating resistance is not set correctly. The remote device could not interpret the protocol command. The response from the remote device was sent too soon. The response timeout monitoring time of the serial gateway is too short. The loopback test jig failed. The communications circuits in the Serial Communications Unit are faulty. A serial gateway interrupted processing between protocol macro steps. Noise occurred. The Serial Communications Mode setting is incorrect. 					○	W494
64A50000 hex	Comparison Error	A comparison error occurred.	<ul style="list-style-type: none"> Loopback test jig failure. Noise The communications circuits in the Serial Communications Unit are faulty. 					○	W494
64A60000 hex	Reception Overflow	More than the specified amount of receive data was received in No-protocol Mode.	<ul style="list-style-type: none"> One or more bytes of data was received after the completion the reception. 					○	W494
64A70000 hex	Command Format Error	An illegal function code or address was specified in a received Modbus-RTU command.	<ul style="list-style-type: none"> An illegal function code, address, or data was specified in a received Modbus-RTU command. 					○	W494

Event code	Event name	Meaning	Assumed cause	Level					Reference
				M a j	P r t	M i n	O b s	I n f o	
84680000 hex	Transmission Error	A transmission error occurred.	<ul style="list-style-type: none"> One of the following errors occurred. Tfs (Send Finished Monitoring Time) Exceeded Tfr (Receive Finished Monitoring Time) Exceeded Tr (Receive Wait Monitoring Time) Exceeded FCS Check Error Command Error Timeout Error Overrun Error Framing Error Parity Error 				○		W494
84690000 hex	Overrun Error	An overrun occurred.	<ul style="list-style-type: none"> In Serial Gateway Mode or Protocol Macro Mode: <ul style="list-style-type: none"> The reception circuits in the Serial Communications Unit are faulty. A transmission error occurred due to noise or other factors. No-protocol Mode: <ul style="list-style-type: none"> The reception buffer received more than 259 bytes of data before the SerialRcv/Serial-RcvNoClear instruction was executed. During Loopback Test <ul style="list-style-type: none"> Loopback test jig failure. Noise The communications circuits in the Serial Communications Unit are faulty. 				○		W494
846A0000 hex	Framing Error	A frame error occurred.	<ul style="list-style-type: none"> In Serial Gateway Mode or Protocol Macro Mode: <ul style="list-style-type: none"> The reception circuits in the Serial Communications Unit are faulty. A transmission error occurred due to noise or other factors. During Loopback Test <ul style="list-style-type: none"> Loopback test jig failure. Noise The communications circuits in the Serial Communications Unit are faulty. 				○		W494

A

Event code	Event name	Meaning	Assumed cause	Level					Reference
				M a j	P r t	M i n	O b s	I n f o	
846B0000 hex	Parity Error	A parity error occurred.	<ul style="list-style-type: none"> In Serial Gateway Mode or Protocol Macro Mode: <ul style="list-style-type: none"> The reception circuits in the Serial Communications Unit are faulty. A transmission error occurred due to noise or other factors. During Loopback Test <ul style="list-style-type: none"> Loopback test jig failure. Noise The communications circuits in the Serial Communications Unit are faulty. 				○		W494
846C0000 hex	Overrun Error, Framing Error, or Parity Error (Transmission Error)	An overrun error, framing error, or parity error occurred.	<ul style="list-style-type: none"> The communications conditions and baud rate settings do not match the host. Noise or other external interference. The baud rate is outside the allowable range or there are bit errors due to different stop bit settings or other parameters. The communications cable wiring is faulty. Terminating resistance is not set correctly for the RS-422A/485 ports. Wiring is faulty or terminating resistance is not set correctly on an NT-AL001 or other Adapter. 				○		W494
846D0000 hex	Transmission Error (CRC Error)	A CRC error occurred.	<ul style="list-style-type: none"> Noise CRC calculation method does not match the device. 				○		W494

CJ-series DeviceNet Units

The section provides tables of the errors (events) that can occur in the following Units.
CJ1W-DRM21

The manual names are given below for the catalog numbers given in the Reference column of the event table.

Cat. No.	Manual name
W497	CJ-series DeviceNet Units Operation Manual for NJ-series CPU Unit

Event code	Event name	Meaning	Assumed cause	Level					Reference
				M a j	P r t	M i n	O b s	I n f o	
04880000 hex	Unit Memory Error	An error occurred when writing to internal memory where the error history is saved.	<ul style="list-style-type: none"> There is a source of noise nearby. Non-volatile memory failure 			○	⊙		W497
04890000 hex	Network Power Error	Network power is not being supplied.	<ul style="list-style-type: none"> Communications power is not being supplied normally from the network. 			○			W497
148D0000 hex	Invalid Scan List Data	There is an error in the contents of the slave scan list or master scan list stored in non-volatile memory.	<ul style="list-style-type: none"> The power was interrupted during writing the scan list to the non-volatile memory. 			○			W497
148E0000 hex	Invalid Setup Data	There is illegal data in the settings for the slave function.	<ul style="list-style-type: none"> The power was interrupted while the system was writing the parameters. Non-volatile memory life 			○			W497
24480000 hex	Node Address Duplicated Error	An error was discovered during the node address duplication check when starting the DeviceNet Unit.	<ul style="list-style-type: none"> The node address of the DeviceNet Unit is also set for another node. 			○			W497
34BC0000 hex	Routing Table Error	There is illegal data in the routing tables set in the CPU Unit.	<ul style="list-style-type: none"> The local DeviceNet Unit is not in the routing tables. The routing table format is incorrect. Reading the routing tables timed out. 			○	⊙		W497



Event code	Event name	Meaning	Assumed cause	Level					Reference
				M a j	P r t	M i n	O b s	I n f o	
34BD0000 hex	Verification Error	The slave information registered in the scan list does not agree with the actual slave information.	<ul style="list-style-type: none"> A slave that is in the scan list does not exist. The node address of the local Unit, which is the master, is registered in the scan list. If the system is set to check the vendor in the detailed verification settings, the vendor of the slave does not match the registration in the scan list. If the connection path is set in the detailed verification settings, then setting the connection path that is set in the scan list failed. The size of the slave I/O data does not match the registration in the scan list. If the device type is set in the detailed verification settings, then setting the device type that is set in the scan list failed. If the product code is set in the detailed verification settings, then setting the product code that is set in the scan list failed. The device does not support the I/O service specified in the scan list. 					○	W497
34BE0000 hex	Structure Error	The scan list is disabled and an error occurred that prevented making I/O allocations.	<ul style="list-style-type: none"> The I/O words allocated to slave overlap. The I/O words allocated to the slave exceed the valid range. The I/O size of the slave exceeds 200 bytes for outputs or 200 bytes for inputs. 					○	W497
34BF0000 hex	Master I/O Refresh Error	The I/O memory in the destination CPU Unit for I/O refreshing could not be found when refreshing the master function data in the CPU Unit.	<ul style="list-style-type: none"> I/O words are allocated in an EM bank that does not exist. 					○	W497

Event code	Event name	Meaning	Assumed cause	Level					Reference
				M a j	P r t	M i n	O b s	I n f o	
34C00000 hex	Master User-set Allocations User Setting Failed	An error occurred in the following operation for user allocation of the master.	<ul style="list-style-type: none"> The master function is not enabled. There is a mistake in the user allocations in the master. CPU Unit is not in PROGRAM mode. More than one software switch changed to TRUE at the same time. Or, another software switch changed to TRUE before processing was completed for a previous software switch. 			○			W497
34C10000 hex	Communications Cycle Time Setting Failed	An error occurred in one of the following operations when setting the communications cycle time.	<ul style="list-style-type: none"> There is an error in the set information. CPU Unit is not in PROGRAM mode. 			○			W497
34C20000 hex	Slave I/O Refresh Error	The I/O memory in the destination CPU Unit for I/O refreshing could not be found when refreshing the slave function data in the CPU Unit.	<ul style="list-style-type: none"> I/O words are allocated in an EM bank that does not exist. 			○			W497
34C30000 hex	Slave User Allocation Area Setting Failed	An error occurred in the following operation for user allocation of the slave.	<ul style="list-style-type: none"> The slave function is not disabled. There is a mistake in the user allocations to a slave. CPU Unit is not in PROGRAM mode. More than one software switch changed to TRUE at the same time. Or, another software switch changed to TRUE before processing was completed for a previous software switch. 			○			W497
64AC0000 hex	Send Timeout Error	A send timeout occurred.	<ul style="list-style-type: none"> There is no slave or other device on the network. The same baud rate is not set for all nodes. Communications cable lengths (trunk line and branch lines) are unsuitable. A communications cable is disconnected or loose. The terminating resistance is somewhere other than the ends of the trunk line. Noise There is an error in the CAN controller. 			○			W497

Event code	Event name	Meaning	Assumed cause	Level					Reference
				M a j	P r t	M i n	O b s	I n f o	
74600000 hex	Master Function Enable/Disable Failed	An operating error occurred when enabling or disabling the master function.	<ul style="list-style-type: none"> An attempt was made to enable the master function when it was already enabled. An attempt was made to disable the master function when it was already disabled. CPU Unit is not in PROGRAM mode. More than one software switch changed to TRUE at the same time. Or, another software switch changed to TRUE before processing was completed for a previous software switch. 			○			W497
74610000 hex	Master Fixed Allocation Area Setting Failed	An error occurred in one of the following operations for fixed allocation of the master.	<ul style="list-style-type: none"> The master function is not enabled. The scan list is not disabled. CPU Unit is not in PROGRAM mode. More than one software switch changed to TRUE at the same time. Or, another software switch changed to TRUE before processing was completed for a previous software switch. 			○			W497

A

Event code	Event name	Meaning	Assumed cause	Level					Reference
				M a j	P r t	M i n	O b s	I n f o	
74620000 hex	Scan List Register/ Clear Failed	An operating error occurred when registering or clearing the scan list by performing one of the following operations.	<ul style="list-style-type: none"> • CPU Unit is not in PROGRAM mode. • Request processing is not possible in this status or the request was made when the operation was already in progress. The following are the main causes of Unit status errors. <ul style="list-style-type: none"> • A software switch operation for the master function was executed when the master function was disabled. • A switch that can be used only when the scan list is disabled was used when the scan list was enabled. • A switch that can be used only when the scan list is enabled was used when the scan list was disabled. • A software switch operation for the slave function was executed when the slave function was disabled. • A configuration error has occurred. • There is an error in the parameters specified in the user settings, and the requested setting could not be made. • More than one software switch changed to TRUE at the same time. Or, another software switch changed to TRUE before processing was completed for a previous software switch. 						W497
74630000 hex	Slave Function Enable/ Disable Failed	An error occurred in one of the following operations in the slave function.	<ul style="list-style-type: none"> • An attempt was made to enable the slave function when it was already enabled. • An attempt was made to disable the slave function when it was already disabled. • CPU Unit is not in PROGRAM mode. • More than one software switch changed to TRUE at the same time. Or, another software switch changed to TRUE before processing was completed for a previous software switch. 						W497

Event code	Event name	Meaning	Assumed cause	Level					Reference
				M a j	P r t	M i n	O b s	I n f o	
74640000 hex	Slave Fixed Allocation Area Setting Failed	An error occurred in one of the following operations for fixed allocation of the slave.	<ul style="list-style-type: none"> The slave function is not disabled. CPU Unit is not in PROGRAM mode. More than one software switch changed to TRUE at the same time. Or, another software switch changed to TRUE before processing was completed for a previous software switch. 			○			W497
84740000 hex	Bus Off Detected	A Bus Off error occurred (i.e., communications stopped because there were too many communications errors).	<ul style="list-style-type: none"> The master and slaves have different baud rates. Communications cable lengths (trunk line and branch lines) are unsuitable. A communications cable is disconnected or loose. The terminating resistance is somewhere other than the ends of the trunk line. Noise 			○			W497
84750000 hex	Remote I/O Communications Error	A timeout occurred in remote I/O communications.	<ul style="list-style-type: none"> The master and slaves have different baud rates. Communications cable lengths (trunk line and branch lines) are unsuitable. A communications cable is disconnected or loose. The terminating resistance is somewhere other than the ends of the trunk line. Noise 			○	⊙		W497
84760000 hex	Remote I/O Communications Error (during Slave Operation)	An error occurred in remote I/O communications.	<ul style="list-style-type: none"> The master is not in operation. The master and slaves have different baud rates. Communications cable lengths (trunk line and branch lines) are unsuitable. A communications cable is disconnected or loose. The terminating resistance is somewhere other than the ends of the trunk line. Noise 			○			W497



Event code	Event name	Meaning	Assumed cause	Level					Reference
				M a j	P r t	M i n	O b s	I n f o	
84770000 hex	Slave COS Send Failed	An attempt was made to send COS data to the master using the Slave COS Send Switch (software switch 2, device variable <i>*_Sw2SlavCOSSendCmd</i>), but the send failed.	<ul style="list-style-type: none"> A COS connection to the master is not open. A Bus Off state occurred. A network power error occurred. A send timeout occurred. 			○			W497
048A0000 hex	File Read/Write Error	An error occurred when user setup data was read from an SD Memory Card in the CPU Unit or when data was written as a file to an SD Memory Card.	<ul style="list-style-type: none"> The available capacity on the SD Memory Card was insufficient to write a file. Write-protection is set on the SD Memory Card when you write to a file. Noise The SD Memory Card is damaged. The CPU Unit has failed. 			⊙	○		W497
148C0000 hex	Invalid Message Timer List Error	The data in the message monitoring timer list is not correct.	<ul style="list-style-type: none"> The power supply was interrupted while writing the message-monitoring timer list to the non-volatile memory. 			⊙	○		W497

CJ-series EtherNet/IP Unit

The section provides tables of the errors (events) that can occur in the following Units.

CJ1W-EIP21

CJ1W-EIP21S

The manual names are given below for the catalog numbers given in the Reference column of the event table.

Cat. No.	Manual name
W495	CJ-series EtherNet/IP Units Operation Manual for NJ-series CPU Unit

Event code	Event name	Meaning	Assumed cause	Level					Reference	
				M a j	P r t	M i n	O b s	I n f o		
047A0000 hex	Unit Memory Error (Device Error)	An error occurred when writing to the error history or device parameters in non-volatile memory in the EtherNet/IP Unit.	<ul style="list-style-type: none"> There is a source of noise nearby. Non-volatile memory failure 					○		W495
047B0000 hex	Non-volatile Memory Error	An error occurred in non-volatile memory.	<ul style="list-style-type: none"> There is a source of noise nearby. Non-volatile memory failure 					○		W495
047C0000 hex	Communications Controller Error	An error occurred in the communications controller.	<ul style="list-style-type: none"> Noise Communications Controller hardware error 					○		W495
14840000 hex	Invalid Communications Parameter	An error was found in the validation check of the parameters for tag data links that are saved in non-volatile memory.	<ul style="list-style-type: none"> The power was interrupted during a download. A communications error occurred during a download. Non-volatile memory failure 					○		W495
14850000 hex	Tag Database Error	A tag database error occurred in the CPU Unit when using variables for tag data links, status layout, etc.	<ul style="list-style-type: none"> The power was interrupted during a download. A communications error occurred during a download. 					○		W495
34A80000 hex	Verification Error	The information registered for a target node in the tag data link parameters is different from the actual node information.	<ul style="list-style-type: none"> The specified target does not exist. Variable names do not match. The connection size is incorrect. Insufficient connection resources 					○		W495

Event code	Event name	Meaning	Assumed cause	Level					Reference
				M a j	P r t	M i n	O b s	I n f o	
34A90000 hex	Tag Data Link Error	There were two or more errors in a connection as an originator. The following are excluded. <ul style="list-style-type: none"> • Connections as a target • Connection time-outs due to a Link OFF Error with the Ethernet switch. 	<ul style="list-style-type: none"> • The power supply to the target node is OFF. • Communications with the target node stop. • The Ethernet cable for Ethernet/IP is disconnected. • The Ethernet cable for Ethernet/IP is disconnected. • Noise 			○			W495
34AA0000 hex	Tag Refresh Error	An unsupported data area or address range is specified for the tag data links.	<ul style="list-style-type: none"> • An unsupported data area or address range was specified for the tag data links. 			○			W495
34AB0000 hex	Basic Ethernet Setting Error	There is an illegal TCP/IP setting.	<ul style="list-style-type: none"> • The power was interrupted during a download. • A communications error occurred during a download. 			○			W495
34AC0000 hex	IP Address Table Error	The IP address table information is incorrect.	<ul style="list-style-type: none"> • The power was interrupted during a download. • A communications error occurred during a download. 			○			W495
34AD0000 hex	IP Router Table Error	The IP router table information is incorrect.	<ul style="list-style-type: none"> • The power was interrupted during a download. • A communications error occurred during a download. 			○			W495
34AE0000 hex	Routing Table Error	The routing table information is incorrect.	<ul style="list-style-type: none"> • The power was interrupted during a download. • A communications error occurred during a download. 			○			W495
34AF0000 hex	Ethernet Advanced Setting Error	There is an illegal FINS setting.	<ul style="list-style-type: none"> • The power was interrupted during a download. • A communications error occurred during a download. 			○			W495
34B00000 hex	Address Mismatch	The host ID of the local IP address is inconsistent with the FINS node address. Or, the last segment of the local IP address is inconsistent with the setting on the node address switches.	<ul style="list-style-type: none"> • The IP address conversion method is set to automatic generation, but the host ID of the local IP address is inconsistent with the FINS node address or the last segment of the local IP address is inconsistent with the setting on the node address switch. 			○			W495
381C0000 hex	Status Area Layout Setting Error	An error occurred in the layout setting of the EtherNet/IP Unit.	<ul style="list-style-type: none"> • There is an error in the layout settings of the EtherNet/IP Unit. 			○			W495

Event code	Event name	Meaning	Assumed cause	Level					Reference
				M a j	P r t	M i n	O b s	I n f o	
54AE0000 hex	Multiple Switches ON Error	More than one software switch changed to TRUE at the same time.	<ul style="list-style-type: none"> More than one software switch changed to TRUE at the same time. Or, another software switch changed to TRUE before processing was completed for a previous software switch. 			○	○		W495
84E00000 hex	IP Address Duplication Error	The same IP address is used more than once.	<ul style="list-style-type: none"> The IP address of the EtherNet/IP port is also used as the IP address of another node. 			○			W495
84E10000 hex	BOOTP Server Error	Connection with the BOOTP server failed.	<ul style="list-style-type: none"> Server setting error (The acquired IP address is illegal.) The server went down. An error occurred in the communications path. 			○			W495
54AF0000 hex	Access Detected Outside Range of Variable	Accessing a value that is out of range was detected for a tag variable that is used in a tag data link.	<ul style="list-style-type: none"> An out-of-range value was written by an EtherNet/IP tag data link for a variable with a specified range. A value that does not specify an enumerator was written by an EtherNet/IP tag data link for an enumeration variable. 				○		W495
84E20000 hex	Link OFF Error	The Ethernet link status turned OFF.	<ul style="list-style-type: none"> The Ethernet cable is disconnected. An Ethernet cable is disconnected or loose. The switching hub power supply is turned OFF. Baud rate mismatch. Noise 			○	○		W495

CJ-series CompoNet Master Unit

The section provides a table of the errors (events) that can occur in the following Unit.
CJ1W-CRM21

The manual names are given below for the catalog numbers given in the Reference column of the event table.

Cat. No.	Manual name
W493	CJ-series CompoNet Master Units Operation Manual for NJ-series CPU Unit

Event code	Event name	Meaning	Assumed cause	Level					Reference
				M a j	P r t	M i n	O b s	I n f o	
349C0000 hex	Registration Table Verification Error	An inconsistency was found when verifying the slave registration table.	<ul style="list-style-type: none"> There is at least one entry in the slave registration table where the node address and Slave Unit model are inconsistent. 			○			W493
349D0000 hex	Slave Unit Duplicated Address Error	The same address is used by more than one Slave Unit or the same word has been allocated to more than one Slave Unit.	<ul style="list-style-type: none"> The same node address is set for more than one Slave Unit. There are no duplicated node addresses set for the Slave Units, but allocated words overlap. A Slave Unit was disconnected from the network, and then another Slave Unit with the same node address but a different I/O capacity joined the network. 			○			W493
349E0000 hex	Repeater Unit Node Duplicated Address Error	The node address of the Repeater Unit is also set for another node.	<ul style="list-style-type: none"> The node address of the Repeater Unit is also used for another node. 			○			W493
84600000 hex	Communications Error	A Slave Unit was disconnected from the network.	<ul style="list-style-type: none"> Cable lengths (trunk line and branch lines) are unsuitable. A cable is disconnected or loose. A terminating resistance is not connected. Or, the terminating resistance is somewhere other than the end of the trunk line. Noise The Slave Unit does not respond to communications from the Master Unit because the Slave Unit is faulty, the line is disconnected, or the communications power supply is interrupted. 			○	⊙		W493

Event code	Event name	Meaning	Assumed cause	Level					Reference
				M a j	P r t	M i n	O b s	I n f o	
84610000 hex	Repeater Unit Communications Error	An error occurred in Repeater Unit communications.	<ul style="list-style-type: none"> Cable lengths (trunk line and branch lines) are unsuitable. A cable is disconnected or loose. A terminating resistance is not connected. Or, the terminating resistance is somewhere other than the end of the trunk line. Noise The Repeater Unit does not respond to communications from the Master Unit because the Repeater Unit is faulty, the line is disconnected, or the communications power is interrupted. 			○	◐		W493
64980000 hex	Representative Warning	A warning has occurred in at least one Slave Unit.	<ul style="list-style-type: none"> A warning has occurred in at least one Slave Unit. 				○		W493
64990000 hex	Representative Alarm	An alarm has occurred in at least one Slave Unit.	<ul style="list-style-type: none"> An alarm has occurred in at least one Slave Unit. 				○		W493



CJ-series EtherCAT Slave Unit

The section provides a table of the errors (events) that can occur in the following Unit.
CJ1W-ECT21

The manual names are given below for the catalog numbers given in the Reference column of the event table.

Cat. No.	Manual name
W542	CJ-series EtherCAT Slave Units Operation Manual for NJ-series CPU Unit

Event code	Event name	Meaning	Assumed cause	Level					Reference
				M a j	P r t	M i n	O b s	I n f o	
05400000 hex	ESC Error	An error occurred in the EtherCAT slave communications controller.	<ul style="list-style-type: none"> An error occurred in the EtherCAT slave communications controller. 			○			W542
05410000 hex	Special Unit Memory Error	An error occurred when writing to internal memory where the error log is saved.	<ul style="list-style-type: none"> Non-volatile memory failure 			○			W542
05420000 hex	SII Unit Verification Error	An error occurred in Slave Unit verification.	<ul style="list-style-type: none"> An error occurred in Slave Unit information. 			○			W542
35680000 hex	I/O Refresh Error	The I/O memory in the destination CPU Unit for I/O refreshing could not be found when refreshing in the CPU Unit.	<ul style="list-style-type: none"> The data area type, data area size and first word in the data area were outside of the specified range. I/O words are allocated in an EM bank that does not exist. 			○			W542
35690000 hex	Mailbox Setting Error	An incorrect mailbox setting was detected for the Sync Manager. (AL-Status Code:0016hex)	<ul style="list-style-type: none"> An incorrect mailbox setting was detected for the Sync Manager. 			○			W542
356A0000 hex	Verification Error	<ul style="list-style-type: none"> An error was detected in the RxPDO settings. (AL-Status Code:001Dhex) An error was detected in the TxPDO settings. (AL-Status Code:001E hex) 	<ul style="list-style-type: none"> An error was detected in the PDO settings. 			○			W542

Event code	Event name	Meaning	Assumed cause	Level					Reference
				M a j	P r t	M i n	O b s	I n f o	
356B0000 hex	Illegal State Transition Request Received	<ul style="list-style-type: none"> An incorrect state transition request was received. (AL-Status Code:0011hex) An unclear state transition request was received. (AL-Status Code:0012hex) 	<ul style="list-style-type: none"> An incorrect state transition request was received. An unclear state transition request was received. 			○			W542
852C0000 hex	I/O Communication Error	Process data communications were stopped for more than the specified period of time.	<ul style="list-style-type: none"> The EtherCAT communications cable is disconnected or broken. There is an error in the EtherCAT master. 			○			W542



A-3 An Error Log Table for CJ-series Special Units

Error logs for CJ-series Special Units are also displayed with event logs. If the upper four digits of the event code are 0000, the lower four digits of the event code give the error code for error logs from CJ-series Special Units.

For descriptions of error codes for the relevant error logs, refer to the manual of models that are displayed in Source Details on the Sysmac Studio or in Source on the HMI. The following table gives the corresponding manuals for models.

Model	Manual name	Cat. No.
CJ1W-AD0□□-□□ CJ1W-DA0□□□ CJ1W-MAD42	CJ-series Analog I/O Units Operation Manual for NJ-series CPU Unit	W490
CJ1W-TC003 CJ1W-TC004 CJ1W-TC103 CJ1W-TC104	CJ-series Temperature Control Units Operation Manual for NJ-series CPU Unit	W491
CJ1W-CT021	CJ-series High-speed Counter Units Operation Manual for NJ-series CPU Unit	W492
CJ1W-PDC15 CJ1W-PH41U CJ1W-AD04U	CJ-series Analog I/O Units Operation Manual for NJ-series CPU Unit	W498
CJ1W-CRM21	CJ-series CompoNet Master Units Operation Manual for NJ-series CPU Unit	W493
CJ1W-SCU22 CJ1W-SCU32 CJ1W-SCU42	CJ-series Serial Communications Units Operation Manual for NJ-series CPU Unit	W494
CJ1W-EIP21 CJ1W-EIP21S	CJ-series EtherNet/IP Units Operation Manual for NJ-series CPU Unit	W495
CJ1W-DRM21	CJ-series DeviceNet Units Operation Manual for NJ-series CPU Unit	W497
CJ1W-ECT21	CJ-series EtherCAT Slave Units Operation Manual for NJ-series CPU Unit	W542
CJ1W-V680C11 CJ1W-V680C12	CJ-series ID Sensor Units Operation Manual for NJ-series CPU Unit	Z317

For example, if the following information is displayed on the Sysmac Studio, refer to descriptions for the error code 000E in the *CJ-series EtherNet/IP Units Operation Manual for NJ-series CPU Unit (Cat. No. W495)*, which is the manual for the CJ1W-EIP21/EIP21S.

Source	Source details	Event name	Event code
I/O bus	Rack 0, Slot 3 CJ1W-EIP21/EIP21S	I/O Bus Error	0x0000000E

The following table gives error logs for CJ-series Special Units. The level of all errors is Observation. The Controller errors do not occur because they are not events.

Event code	Error name
00000001 hex	CPU Unit watchdog timer error
00000002 hex	CPU Unit service monitor error, or Cyclic refresh Time-out
00000003 hex	CPU Unit shared RAM error
00000004 hex	CPU Bus Unit ID number error
00000005 hex	Unit number error
00000006 hex	CPU Unit error
00000007 hex	PF Return
00000008 hex	System setting error
00000009 hex	System setting read error
0000000A hex	Routing table lost
0000000B hex	Routing Table Error
0000000C hex	Routing table read error
0000000D hex	PLC model error
0000000E hex	I/O Bus Error
0000000F hex	PLC Initialization error
00000010 hex	Insufficient system setup area
00000011 hex	Event timeout
00000012 hex	CPU Unit memory error
00000013 hex	CPU Unit protected
00000014 hex	Inner bus error
00000015 hex	CPU fatal error
00000016 hex	CPU Unit non-fatal error
00000017 hex	Tag database error
00000101 hex	Transmission failed (local node not in network)
00000102 hex	Transmission failed (Time out with token)
00000103 hex	Transmission failed (retry count exceeded)
00000104 hex	Transmission failed (max. number of frames exceeded)
00000105 hex	Transmission failed (node address setting error)
00000106 hex	Transmission failed (node address duplication error)
00000107 hex	Transmission failed (destination node not in network)
00000108 hex	Transmission failed (specified Unit does not exist)
00000109 hex	Transmission failed (destination busy)
0000010A hex	Transmission failed (communication controller error)
0000010B hex	Transmission failed (PLC error)
0000010C hex	Transmission failed (unit number incorrect)
0000010D hex	Transmission failed (no destination address in routing table)
0000010E hex	Transmission failed (routing table not registered)
0000010F hex	Transmission failed (routing table error)
00000110 hex	Transmission failed (too many relay points)
00000111 hex	Transmission failed (command packet too long)
00000112 hex	Transmission failed (header error)
00000113 hex	Transmission failed (I/O setting error)
00000114 hex	Transmission failed (CPU Bus error)
00000115 hex	Transmission failed (redundant I/O allocations)
00000116 hex	Transmission failed (CPU Bus Unit error)

Event code	Error name
00000117 hex	Internal buffer full
00000118 hex	Illegal packet discarded
00000119 hex	Transmission failed (local node busy)
0000011A hex	Packets discarded due to initialization
0000011B hex	Packets discarded due to parity error
0000011C hex	Packets discarded due to framing error
0000011D hex	Packets discarded due to overrun error
0000011E hex	Packets discarded due to FCS error
0000011F hex	Packets discarded due to break detection
00000120 hex	Unexpected routing error
00000121 hex	Packet discarded (no setting in IP address table)
00000122 hex	Packet discarded (service not supported in current mode)
00000123 hex	Packet discarded (internal send buffer full)
00000124 hex	Routing failed (maximum frame size exceeded)
00000125 hex	Packet discarded (response timeout)
00000201 hex	Network parameter file loss
00000202 hex	Network parameter file destroyed
00000203 hex	EEPROM error
00000206 hex	Participating nodes decreased (local node still participating)
00000207 hex	Participating nodes decreased (local node not participating)
00000208 hex	Polling node changed
00000209 hex	Inconsistent network parameter
0000020A hex	RESET error
0000020B hex	SELF-TEST error completed
0000020C hex	Time out with token
0000020D hex	Time out with polling
0000020E hex	Communication chip controller WDT error
0000020F hex	Communication chip controller chip error
00000210 hex	Communications controller send error
00000211 hex	Duplicate address error
00000212 hex	Transceiver error
00000213 hex	Server demon startup error
00000214 hex	Node address setting error
00000215 hex	Network participation failed
00000216 hex	Backup power supply error (optical Units only)
00000217 hex	Loop error
00000218 hex	Message send error
00000219 hex	Network status unstable
0000021A hex	Logic error in setting table
0000021B hex	Hardware error
0000021C hex	Datalink error inactive
0000021D hex	Datalink table communications cycle time setting error
0000021E hex	Network disconnection occurred
00000220 hex	Participating nodes reduced (removed node information)
00000221 hex	Participating nodes reduced (removed node information)
00000222 hex	Participating nodes reduced (removed node information)
00000223 hex	Participating nodes reduced (removed node information)

Event code	Error name
0000230 hex	Data link stop requested
00002B0 hex	FALS detected
0000300 hex	Packet Discarded (Parameter Error), Out of Range, or Flash failure
0000301 hex	Protocol macro operation error
0000302 hex	Packet discarded due to protocol violation
0000303 hex	Invalid DM setting
0000304 hex	Sensor error
0000305 hex	Invalid Unit type
0000310 hex	Invalid BCD-code, or System parameter destroyed
0000311 hex	Program destroyed
0000312 hex	G unjust instruction
0000313 hex	Program range exceeded
0000314 hex	Origin signal
0000315 hex	Deviation counter over flow
0000316 hex	ABS data error
0000317 hex	No origin proximity
0000318 hex	CW direction over travelled
0000319 hex	CCW direction over travelled
000031A hex	Both direction over travelled
000031B hex	Current position counter over flow
000031C hex	ABS multiple rotation error
000031D hex	Field back pulse error
0000320 hex	PARUSU RE-TO RENJI FUSEI
0000330 hex	Invalid Range Limits(s)/Comparison Value, or Low battery
0000331 hex	Duplicate Target Error
0000335 hex	Duplicate Rate Range Error
0000340 hex	Bus Off detected
0000341 hex	Network power supply error
0000342 hex	Transmission timeout
0000343 hex	Structure error
0000344 hex	Verification error
0000345 hex	Remote I/O communications error
0000346 hex	Remote I/O communications stopped (remote I/O communications error)
0000347 hex	I/O refreshing error
0000348 hex	Message discarded (new request was received)
0000350 hex	Invalid Control Code, or NC Unit error
0000351 hex	X-axis error
0000352 hex	Y-axis error
0000353 hex	Z-axis error
0000354 hex	U-axis error
0000360 hex	Invalid number of words, or Unit system error
0000370 hex	Verification error (OUT slave missing)
0000371 hex	Verification error (IN slave missing)
0000372 hex	Verification error (Unregistered OUT slave participating)
0000373 hex	Verification error (Unregistered IN slave participating)
0000374 hex	Communications error
0000375 hex	Communication stopped due to communications error

Event code	Error name
00000376 hex	Address duplication error
00000378 hex	Illegal Repeater Unit/configuration error
000003B0 hex	DM system setting read error
000003B1 hex	Commands error
000003B2 hex	GP-IB I/F error
000003B3 hex	GP-IB send time out error
000003B4 hex	GP-IB receive time out error
000003C0 hex	Lower-Level Communication Error or FINS/TCP settings error
000003C1 hex	Server settings error
000003C2 hex	FINS/TCP packets discarded
000003C3 hex	FINS/UDP packets discarded
000003C4 hex	Server connection error
000003C5 hex	Mail maintenance function error
000003C6 hex	Clock information write error
000003D0 hex	Ethernet basic setting error
000003D1 hex	Ethernet advanced setting error
000003D2 hex	Packet discarded
000003D3 hex	Link OFF error
000003D4 hex	Verification error (Tag data link)
000003D5 hex	Tag data link error
00000400 hex	Setting of Reset with Z-Phase
00000412 hex	Invalid Count Range
00000413 hex	Invalid Counter Present Value
00000420 hex	Invalid Rate Range Limits
00000430 hex	Invalid Range Limits(s) / Comparison Value
00000431 hex	Duplicate Target Error
00000435 hex	Duplicate Rate Range Error
00000450 hex	Overflow
00000460 hex	Underflow
00000470 hex	Invalid Preset Value
00000480 hex	External Interrupt Task Buffer Full
00000490 hex	Parity error/Not Ready/Time-out
00000500 hex	System call error (address error)
00000501 hex	System call error (parameter error)
00000502 hex	System call error (error in the board)
00000503 hex	System call error (block error)
00000504 hex	System call error (command error)
00000505 hex	Message send failed
00000510 hex	Comm server startup condition file loss
00000511 hex	Comm server startup condition file undefined
00000512 hex	Comm server startup failed
00000513 hex	Temperature error
00000514 hex	Low battery voltage
00000515 hex	HDD-0 error
00000516 hex	HDD-1 error
00000517 hex	Message send failed
00000601 hex	CPU Bus Unit error

Event code	Error name
00000602 hex	CPU Bus Unit memory error
00000701 hex	Configuration error
00000702 hex	I/O area overlap
00000703 hex	I/O area range exceeded
00000704 hex	Unsupported slave
00000705 hex	Verification error (slave missing)
00000706 hex	Verification error (slave I/O size differs)
00000707 hex	Communication error
00000708 hex	Scan list operation failed
00000709 hex	PLC mounting error
00000781 hex	Node address duplication
00000782 hex	Bus Off detected
00000783 hex	No communications power supply
00000784 hex	Send timeout

A-4 Events in Order of Event Codes

This section provides a table of all events in order of the event codes. Events that are not errors are also given in the tables.

A-4-1 Interpreting Error Descriptions

The contents of the error tables are described below.

Item	Description
Event code	The event code of the error in the NJ/NX-series Controller is given. The codes are given in eight hexadecimal digits.
Event name	The name of the error is given
Functional classification	A functional classification of the source is given.
Reference	The catalog number of the manual that provides details on the event are given.

Refer to information for the specified functional classification of the error in the error descriptions in the manual given in the Reference column in the tables for detailed information on an error.

The manual names are given below for the catalog numbers.

Cat. No.	Manual name
W503	NJ/NX-series Troubleshooting Manual
W521	NX-series Digital I/O Units User's Manual
W522	NX-series Analog I/O Units User's Manual for Analog Input Units and Analog Output Units
W523	NX-series System Unit User's Manual
W527	NJ/NX-series Database Connection CPU Units User's Manual
W528	NJ-series SECS/GEM CPU Units User's Manual (NJ501-1340)
W539	NJ-series NJ Robotics CPU Unit User's Manual
W540	NX-series Communications Interface Units User's Manual
W565	NX-series Load Cell Input Unit User's Manual
W566	NX-series Analog I/O Units User's Manual for Temperature Input Units and Heater Burnout Detection Units
W647	NX-series High-speed Counter Units User's Manual
W490	CJ-series Analog I/O Units Operation Manual for NJ-series CPU Unit
W491	CJ-series Temperature Control Units Operation Manual for NJ-series CPU Unit
W492	CJ-series High-speed Counter Units Operation Manual for NJ-series CPU Unit
W498	CJ-series Analog I/O Units Operation Manual for NJ-series CPU Unit
W488	GX-series EtherCAT Slave Units User's Manual
W493	CJ-series CompoNet Master Units Operation Manual for NJ-series CPU Unit
W494	CJ-series Serial Communications Units Operation Manual for NJ-series CPU Unit
W495	CJ-series EtherNet/IP Units Operation Manual for NJ-series CPU Unit
W497	CJ-series DeviceNet Units Operation Manual for NJ-series CPU Unit
W519	NX-series EtherCAT Coupler Unit User's Manual
W542	CJ-series EtherCAT Slave Units Operation Manual for NJ-series CPU Unit
W570	IO-Link System User's Manual
W588	NJ/NX-series CPU Unit OPC UA User's Manual

Cat. No.	Manual name
I574	MX2/RX Series Inverter EtherCAT Communication Unit User's Manual
I576	AC Servomotors/Servo Drives G5-series with Built-in EtherCAT Communications User's Manual
I577	AC Servomotors/Servo Drives G5-series with Built-in EtherCAT Communications Linear Motor Type User's Manual
W524	NX-series Position Interface Units User's Manual
I586	AC Servomotors/Servo Drives 1S-series with Built-in EtherCAT Communications User's Manual
O030	NJ/NY-series NC Integrated Controller User's Manual
O037	NJ-series Robot Integrated CPU Unit User's Manual
I621	AC Servomotors/Servo Drives 1S-series with Built-in EtherCAT Communications and Safety Functionality User's Manual
E413	EtherCAT Digital-type Sensor Communications Unit Operation Manual
E429	EtherCAT Digital Sensor Communications Unit Operation Manual
Z317	CJ-series ID Sensor Units Operation Manual for NJ-series CPU Unit
Z314	FQ-M-series Specialized Vision Sensor for Positioning User's Manual
Z342	FH/FZ5 Vision System FH/FZ5 Series User's Manual for Communications Settings
Z332	ZW-CE1□T Confocal Fiber Type Displacement Sensor User's Manual
Z930	NX-series Safety Control Unit User's Manual
H228	NX-series Temperature Control Units User's Manual
W627	NX-series EtherNet/IP Unit User's Manual

A-4-2 Error Table

Event code	Event name	Functional classification	Reference
00070000 hex	Real-Time Clock Stopped	Errors for Self Diagnosis	W503
00080000 hex	Real-Time Clock Failed	Errors for Self Diagnosis	W503
00090000 hex	DIP Switch Setting Error	Errors for Self Diagnosis	W503
000B0000 hex	Low Battery Voltage	Errors for Self Diagnosis	W503
000C0000 hex	CPU Unit Overheat	Errors for Self Diagnosis	W503
000D0000 hex	Internal Bus Check Error	Errors for Self Diagnosis	W503
000E0000 hex	Non-volatile Memory Life Exceeded	Errors for Self Diagnosis	W503
000F0000 hex	SD Memory Card Invalid Type	Errors for Self Diagnosis	W503
00100000 hex	SD Memory Card Life Exceeded	Errors for Self Diagnosis	W503
00110000 hex	CPU Unit Overheat (Operation Stopped)	Errors for Self Diagnosis	W503
00120000 hex	Slow Fan	Errors for Self Diagnosis	W503
00130000 hex	Main Memory Check Error	Errors for Self Diagnosis	W503
00150000 hex	Non-volatile Memory Life Warning	Errors for Self Diagnosis	W503
00200000 hex	Non-volatile Memory Hardware Error	NX-series Digital I/O Units, NX-series Analog I/O Units, NX-series System Units, NX-series Position Interface Units, NX-series Communications Interface Units, NX-series Load Cell Input Units, NX-series IO-Link Master Units, NX-series Temperature Control Units, and NX-series High-speed Counter Units	W521 W522 W566 W523 W524 W540 W565 W570 H228 W647
00210000 hex	Bus Controller Error	NX-series EtherCAT Coupler Unit	W519
00220000 hex	Non-volatile Memory Hardware Error	NX-series EtherCAT Coupler Unit	W519
00640000 hex	Main Memory Check Error	X Bus Unit	W503
00650000 hex	Non-volatile Memory Life Warning	X Bus Unit	W503
04010000 hex	I/O Bus Check Error	Errors Related to CJ-series Unit Configuration	W503
04020000 hex	PLC System Information	Errors Related to CJ-series Unit Configuration	W503
04100000 hex	NX Bus Controller Error	NX Bus	W503
04110000 hex	NX Bus Hardware Error	NX Bus	W503
04200000 hex	Communications Controller Error	EtherNet/IP	W503
04210000 hex	Communications Controller Error	EtherNet/IP	W503
04310000 hex	Communications Controller Error	NX-series EtherNet/IP Unit	W627
04400000 hex	Communications Controller Error	EtherCAT Master	W503

Event code	Event name	Functional classification	Reference
04600000 hex	A/D Conversion Error	CJ-series Analog I/O Units and CJseries Process I/O Units	W490 W498
04610000 hex	Cold Junction Sensor Error	CJ-series Process I/O Units	W498
04620000 hex	Non-volatile Memory Error	CJ-series Analog I/O Units and CJseries Process I/O Units	W490 W498
04680000 hex	Cold Junction Sensor Error	CJ-series Temperature Control Units	W491
046C0000 hex	Unit Status, Antenna Power Supply Error	CJ-series ID Sensor Units	Z317
046D0000 hex	Unit Status, Memory Error	CJ-series ID Sensor Units	Z317
046E0000 hex	Results Information, Antenna Error	CJ-series ID Sensor Units	Z317
046F0000 hex	Unit Status, Unit Busy	CJ-series ID Sensor Units	Z317
04740000 hex	Error Log Data Error	CJ-series Serial Communications Units	W494
04750000 hex	DTR Check Error	CJ-series Serial Communications Units	W494
04760000 hex	CTS Check Error	CJ-series Serial Communications Units	W494
047A0000 hex	Unit Memory Error (Device Error)	CJ-series EtherNet/IP Units	W495
047B0000 hex	Non-volatile Memory Error	CJ-series EtherNet/IP Units	W495
047C0000 hex	Communications Controller Error	CJ-series EtherNet/IP Units	W495
04880000 hex	Unit Memory Error	CJ-series DeviceNet Units	W497
04890000 hex	Network Power Error	CJ-series DeviceNet Units	W497
048A0000 hex	File Read/Write Error	CJ-series DeviceNet Units	W497
04A00000 hex	Expansion Unit Hardware Error	GX-series EtherCAT Slave Units	W488
04A10000 hex	Non-volatile Memory Hardware Error	GX-series EtherCAT Slave Units, MX2/RX-series Inverters with Ether-CAT Communications Units, Ether-CAT M3X Photoelectric Fiber Amplifiers, E3X-series Fiber Sensors with EtherCAT Communications Unit for Digital Sensors, and Ether-CAT Digital Sensor Communications Units	W488 I574 E413 E429 W570 W640
04A20000 hex	Slave Hardware Error	GX-series EtherCAT Slave Units	W488 W570
04A80000 hex	Control Power Supply Undervoltage	Servo G5 and G5 Linear	I576 I577
04A90000 hex	Overvoltage	Servo G5 and G5 Linear	I576 I577
04AA0000 hex	Main Circuit Power Supply Undervoltage (Undervoltage between positive and negative terminals)	Servo G5 and G5 Linear	I576 I577
04AB0000 hex	Main Circuit Power Supply Undervoltage (AC Cutoff Detected)	Servo G5 and G5 Linear	I576 I577

Event code	Event name	Functional classification	Reference
04AC0000 hex	Overcurrent	Servo G5 and G5 Linear	I576 I577
04AD0000 hex	IPM Error	Servo G5 and G5 Linear	I576 I577
04AE0000 hex	Regeneration Tr Error	Servo G5 and G5 Linear	I576 I577
04AF0000 hex	Encoder Phase-Z Error	Servo G5	I576
04B00000 hex	Encoder CTS Signal Error	Servo G5	I576
04B10000 hex	Node Address Setting Error	Servo G5 and G5 Linear	I576 I577
04B20000 hex	Other Errors	G5 Linear	I577
04B30000 hex	Regeneration Circuit Error Detected during Power ON	Servo 1S	I586
04B50000 hex	Inrush Current Prevention Circuit Error	Servo 1S	I586
04B60000 hex	Regeneration Circuit Error	Servo 1S	I586 I621
04BA0000 hex	Connection Error between Inverter and Communications Unit	MX2/RX-series Inverters with EtherCAT Communications Units	I574
04BB0000 hex	Inverter Warning	MX2/RX-series Inverters with EtherCAT Communications Units	I574
04BC0000 hex	Inverter Trip	MX2/RX-series Inverters with EtherCAT Communications Units	I574
04C40000 hex	Sensor Communications Error	E3X-series Fiber Sensors with EtherCAT Communications Unit for Digital Sensors and EtherCAT Digital Sensor Communications Units	E413 E429
04C50000 hex	Sensor Communications Has Not Been Established	E3X-series Fiber Sensors with EtherCAT Communications Unit for Digital Sensors and EtherCAT Digital Sensor Communications Units	E413 E429
04D00000 hex	Hardware error	ZW-CE1□T Confocal Fiber Type Displacement Sensor	Z332
05010000 hex	ESC Error	NX-series EtherCAT Coupler Unit	W519
05020000 hex	ESC Initialization Error	NX-series EtherCAT Coupler Unit	W519
05030000 hex	Slave Unit Verification Error	NX-series EtherCAT Coupler Unit	W519
05100000 hex	A/D Converter Error	NX-series Analog I/O Units and NX-series Temperature Control Units	W566 H228
05110000 hex	Cold Junction Sensor Error	NX-series Analog I/O Units and NX-series Temperature Control Units	W566 H228
05120000 hex	A/D Conversion Error	NX-series Load Cell Input Units	W565

Event code	Event name	Functional classification	Reference
05200000 hex	System Error	NX-series Safety Control Unit	Z930
05210000 hex	Internal Circuit Error at Safety Input	NX-series Safety Control Unit	Z930
05220000 hex	Internal Circuit Error at Test Output	NX-series Safety Control Unit	Z930
05230000 hex	Internal Circuit Error at Safety Output	NX-series Safety Control Unit	Z930
05400000Hex	ESC Error	CJ-series EtherCAT Slave Unit	W542
05410000Hex	Special Unit Memory Error	CJ-series EtherCAT Slave Unit	W542
05420000Hex	SII Unit Verification Error	CJ-series EtherCAT Slave Unit	W542
05430000 hex	ESC Error	Servo 1S	I586 I621
05440000 hex	Option Board Error	Built-in I/O and Option Boards	W503
08010000 hex	Battery Warning	Servo G5	I576
08020000 hex	Fan Warning	Servo G5 and G5 Linear	I576 I577
08030000 hex	Encoder Communications Warning	Servo G5	I576
08040000 hex	Encoder/Serial Conversion Unit Overheating Warning	Servo G5 and G5 Linear	I576 I577
08050000 hex	Life Expectancy Warning	Servo G5 and G5 Linear	I576 I577
08060000 hex	External Encoder Error Warning	Servo G5 and G5 Linear	I576 I577
08070000 hex	External Encoder Communications Warning	Servo G5 and G5 Linear	I576 I577
08080000 hex	Encoder Communications Disconnection Error	Servo G5	I576
08090000 hex	Encoder Communications Error	Servo G5	I576
080A0000 hex	Encoder Communications Data Error	Servo G5	I576
080B0000 hex	Safety Input Error	Servo G5 and G5 Linear	I576 I577
080C0000 hex	External Encoder Connection Error	Servo G5 and G5 Linear	I576 I577
080D0000 hex	External Encoder Communications Data Error	Servo G5 and G5 Linear	I576 I577
080E0000 hex	External Encoder Status Error 0	Servo G5 and G5 Linear	I576 I577
080F0000 hex	External Encoder Status Error 1	Servo G5 and G5 Linear	I576 I577
08100000 hex	External Encoder Status Error 2	Servo G5 and G5 Linear	I576 I577
08110000 hex	External Encoder Status Error 3	Servo G5 and G5 Linear	I576 I577
08120000 hex	External Encoder Status Error 4	Servo G5 and G5 Linear	I576 I577
08130000 hex	External Encoder Status Error 5	Servo G5 and G5 Linear	I576 I577

Event code	Event name	Functional classification	Reference
08140000 hex	Phase-A Connection Error	Servo G5 and G5 Linear	I576 I577
08150000 hex	Phase-B Connection Error	Servo G5 and G5 Linear	I576 I577
08160000 hex	Phase-Z Connection Error	Servo G5 and G5 Linear	I576 I577
08170000 hex	Encoder Data Restoration Error	Servo G5	I576
08180000 hex	External Encoder Data Restoration Error	Servo G5	I576
081C0000 hex	Capacitor Lifetime Warning	Servo 1S	I586 I621
081D0000 hex	Inrush Current Prevention Relay Lifetime Warning	Servo 1S	I586 I621
081F0000 hex	Brake Interlock Output Relay Lifetime Warning	Servo 1S	I586
08210000 hex	Fan/Power Supply Error	FH/FZ5 Series Vision System	Z342
08220000 hex	Camera Overcurrent Detected	FH/FZ5 Series Vision System	Z342
08230000 hex	Parallel I/O Overcurrent Detected	FH/FZ5 Series Vision System	Z342
08390000 hex	Power Module Error	Servo 1S	I586 I621
083A0000 hex	Encoder Communications Warning	Servo 1S	I586
083B0000 hex	Self-diagnosis Error	Servo 1S	I586 I621
083C0000 hex	Main Circuit Temperature Monitoring Circuit Failure	Servo 1S	I586 I621
083D0000 hex	Fan Error	Servo 1S	I586 I621
083F0000 hex	Regeneration Processing Error	Servo 1S	I586 I621
08410000 hex	Overvoltage Error	Servo 1S	I586 I621
08420000 hex	Motor Overheat Error	Servo 1S	I586
08430000 hex	1-rotation Counter Error	Servo 1S	I586 I621
08440000 hex	Overspeed Error	Servo 1S	I586
08450000 hex	Encoder Memory Error	Servo 1S	I586 I621
08460000 hex	Absolute Position Detection Error	Servo 1S	I586 I621
08470000 hex	Encoder Lifetime Warning	Servo 1S	I586 I621
08480000 hex	Main Power Supply Undervoltage (insufficient voltage between P and N)	Servo 1S	I586 I621
08490000 hex	Overcurrent Error	Servo 1S	I586 I621
084A0000 hex	Encoder Communications Disconnection Error	Servo 1S	I586

Event code	Event name	Functional classification	Reference
084B0000 hex	Encoder Communications Error	Servo 1S	I586 I621
084C0000 hex	Fan Rotation Warning	Servo 1S	I586 I621
084D0000 hex	Non-volatile Memory Hardware Error	Servo 1S	I586 I621
084E0000 hex	Absolute Encoder Counter Overflow Warning	Servo 1S	I586 I621
086D0000 hex	Motor Temperature Error	Servo 1S	I621
086E0000 hex	Encoder Error	Servo 1S	I621
086F0000 hex	Encoder Power Supply Error	Servo 1S	I621
08700000 hex	Encoder Self-diagnosis Error	Servo 1S	I621
08710000 hex	Internal Circuit Error at SF Input	Servo 1S	I621
08720000 hex	Internal Circuit Error at SOPT Input	Servo 1S	I621
08730000 hex	Internal Circuit Error at Test Output	Servo 1S	I621
08740000 hex	Internal Circuit Error at SBC Output	Servo 1S	I621
08750000 hex	Overspeed Error	Servo 1S	I621
08760000 hex	Absolute Encoder Multirotation Counter Error	Servo 1S	I621
08770000 hex	Safety Relay Lifetime Warning	Servo 1S	I621
08780000 hex	Encoder Communications Disconnection Error	Servo 1S	I621
10010000 hex	Non-volatile Memory Restored or Formatted	Errors for Self Diagnosis	W503
10020000 hex	Non-volatile Memory Data Corrupted	Errors for Self Diagnosis	W503
10030000 hex	SD Memory Card Invalid Format	Errors for Self Diagnosis	W503
10040000 hex	SD Memory Card Restored or Formatted	Errors for Self Diagnosis	W503
10060000 hex	SD Memory Card Data Corrupted	Errors for Self Diagnosis	W503
10070000 hex	SD Memory Card Access Power OFF Error	Errors for Self Diagnosis	W503
10080000 hex	Main Memory Check Error	Errors for Self Diagnosis	W503
10090000 hex	Battery-backup Memory Check Error	Errors for Self Diagnosis	W503
100A0000 hex	Data Not Saved to Battery-backup Memory	Errors for Self Diagnosis	W503
100B0000 hex	Non-volatile Memory Data Corrupted	Errors for Self Diagnosis	W503
100C0000 hex	Event Level Setting Error	Errors for Self Diagnosis	W503
100F0000 hex	Present Values of Retained Variables Restoration Error	Errors for Self Diagnosis	W503
10100000 hex	Present Values of Retained Variables Not Saved	Errors for Self Diagnosis	W503
10130000 hex	PLC System Information	Errors for Self Diagnosis	W503

Event code	Event name	Functional classification	Reference
10200000 hex	User Program/Controller Configurations and Setup Transfer Error	Errors Related to Controller Operation	W503
10210000 hex	Illegal User Program Execution ID	Errors Related to Controller Operation	W503
10230000 hex	Event Log Save Error	Errors Related to Controller Operation	W503
10240000 hex	Illegal User Program	Errors Related to Controller Operation	W503
10250000 hex	Illegal User Program/Controller Configurations and Setup	Errors Related to Controller Operation	W503
10260000 hex	Trace Setting Transfer Failure	Errors Related to Controller Operation	W503
10270000 hex	Error in Starting Automatic Transfer	Errors Related to Controller Operation	W503
10280000 hex	Error in Executing Automatic Transfer	Errors Related to Controller Operation	W503
10290000 hex	Backup Failed to Start	Errors Related to Controller Operation	W503
102A0000 hex	Backup Failed	Errors Related to Controller Operation	W503
102B0000 hex	Restore Operation Failed to Start	Errors Related to Controller Operation	W503
102C0000 hex	Restore Operation Failed	Errors Related to Controller Operation	W503
102D0000 hex	CJ-series Unit Backup Failed	Errors Related to CJ-series Unit Configuration	W503
102E0000 hex	CJ-series Unit Restore Operation Failed	Errors Related to CJ-series Unit Configuration	W503
102F0000 hex	EtherCAT Slave Backup Failed	EtherCAT Master	W503
10300000 hex	EtherCAT Slave Restore Operation Failed	EtherCAT Master	W503
10310000 hex	Incorrect SD Memory Card Removal	Errors for Self Diagnosis	W503
10320000 hex	SD Memory Card Program Transfer Failed to Start	Errors Related to Controller Operation	W503
10330000 hex	SD Memory Card Program Transfer Pre-execution Check Error	Errors Related to Controller Operation	W503
10340000 hex	Error in Executing SD Memory Card Program Transfer	Errors Related to Controller Operation	W503
103C0000 hex	NX Unit Backup Failed	NX Bus	W503
103D0000 hex	NX Unit Restore Operation Failed	NX Bus	W503
103E0000 hex	Restore Pre-execution Check Failure	Errors Related to Controller Operation	W503
103F0000 hex	Online Edits Transfer Failure	Errors Related to Controller Operation	W503
10400000 hex	Analog Unit Calibration Parameter Error	NX-series Analog I/O Units	W522

Event code	Event name	Functional classification	Reference
10410000 hex	Control Parameter Error in Master	NX-series Digital I/O Units, NX-series Analog I/O Units, NX-series Position Interface Units, NX-series Communications Interface Units, NX-series Load Cell Input Units, NX-series IO-Link Master Units, NX-series Temperature Control Units, and NX-series High-speed Counter Units	W521 W522 W566 W524 W540 W565 W570 H228 W647
10420000 hex	Non-volatile Memory Control Parameter Error	NX-series EtherCAT Coupler Unit	W519
10430000 hex	Memory Corruption Detected	NX-series EtherCAT Coupler Unit	W519
10440000 hex	Unit Calibration Value Error	NX-series Load Cell Input Units	W565
10450000 hex	Actual Load Calibration Value Error	NX-series Load Cell Input Units	W565
10460001 hex	EtherCAT Slave Backup Failed	EtherCAT Master	W503
10470002 hex	EtherCAT Slave Restore Operation Failed	EtherCAT Master	W503
10500000 hex	NX Bus Communications Settings Read Error	NX-series Safety Control Unit	Z930
10510000 hex	Safety Application Data Read Error	NX-series Safety Control Unit	Z930
10520000 hex	NX Bus Communications Settings and Safety Application Data Mismatch	NX-series Safety Control Unit	Z930
10530000 hex	Non-volatile Memory Access Error	NX-series Safety Control Unit	Z930
10600000 hex	NX Bus Memory Check Error	NX Bus	W503
10610000 hex	Failed to Read NX Unit Operation Settings	NX Bus	W503
10620000 hex	NX Unit Event Log Save Error	NX Bus	W503
10630000 hex	Safety Data Logging Failed to Start	Errors Related to Controller Operation	W503
10640000 hex	Safety Data Log File Save Failed	Errors Related to Controller Operation	W503
11000000 hex	X Bus Unit Settings Transfer Error	X Bus Unit	W503
11010000 hex	Event Log Save Error	X Bus Unit	W503
110C0000 hex	Incorrect X Bus Unit Settings	X Bus Unit	W503
110D0000 hex	Present Values of Retained Variables Not Saved	X Bus Unit	W503
110E0000 hex	Non-volatile Memory Restored or Formatted	X Bus Unit	W503
110F0000 hex	Non-volatile Memory Data Corrupted	X Bus Unit	W503
11100000 hex	Main Memory Check Error	X Bus Unit	W503
11110000 hex	X Bus Common System Information	X Bus Unit	W503
14010000 hex	CPU Bus Unit Setup Area Error	Errors Related to FINS Communications	W503

Event code	Event name	Functional classification	Reference
14200000 hex	MAC Address Error	EtherNet/IP	W503
14210000 hex	Identity Error	EtherNet/IP	W503
14220000 hex	EtherNet/IP Processing Error	EtherNet/IP	W503
14230000 hex	MAC Address Error	EtherNet/IP	W503
14310000 hex	MAC Address Error	NX-series EtherNet/IP Unit	W627
14340000 hex	Ethernet Processing Error	NX-series EtherNet/IP Unit	W627
14400000 hex	MAC Address Error	EtherCAT Master	W503
14600000 hex	Absolute Encoder Home Offset Read Error	General Motion Control	W503
14610000 hex	Motion Control Parameter Setting Error	General Motion Control	W503
14620000 hex	Cam Data Read Error	General Motion Control	W503
14630000 hex	Cam Table Save Error	General Motion Control	W503
14800000 hex	Protocol Data Error	CJ-series Serial Communications Units	W494
14840000 hex	Invalid Communications Parameter	CJ-series EtherNet/IP Units	W495
14850000 hex	Tag Database Error	CJ-series EtherNet/IP Units	W495
148C0000 hex	Invalid Message Timer List Error	CJ-series DeviceNet Units	W497
148D0000 hex	Invalid Scan List Data	CJ-series DeviceNet Units	W497
148E0000 hex	Invalid Setup Data	CJ-series DeviceNet Units	W497
14A00000 hex	Non-volatile Memory Checksum Error	GX-series EtherCAT Slave Units, E3X-series Fiber Sensors with EtherCAT Communications Unit for Digital Sensors, and EtherCAT Digital Sensor Communications Units	W488 E413 E429 W570 W640
14A80000 hex	Object Error	Servo G5 and G5 Linear	I576 I577
14A90000 hex	Object Error	Servo G5 and G5 Linear	I576 I577
14AA0000 hex	Object Error	Servo G5 and G5 Linear	I576 I577
14AB0000 hex	Object Corrupted	Servo G5 and G5 Linear	I576 I577
14AC0000 hex	Object Corrupted	Servo G5 and G5 Linear	I576 I577
14AD0000 hex	Object Corrupted	Servo G5 and G5 Linear	I576 I577
14B00000 hex	Linearity Correction Data Error	ZW-CE1□T Confocal Fiber Type Displacement Sensor	Z332
14B10000 hex	Linearity Correction Data Read Error	ZW-CE1□T Confocal Fiber Type Displacement Sensor	Z332
14B20000 hex	System Setting Error	ZW-CE1□T Confocal Fiber Type Displacement Sensor	Z332
14B30000 hex	Bank Data Error	ZW-CE1□T Confocal Fiber Type Displacement Sensor	Z332
14C00000 hex	Unit Calibration Value Parity Error	NX-series Analog I/O Units	W522

Event code	Event name	Functional classification	Reference
14C10000 hex	Invalid Tuning Parameters Saved in the Unit	NX-series Temperature Control Units	H228
14D00000 hex	Spool Memory Corrupted	DB Connection Service	W527
14D20000 hex	Execution Log Save Failed	DB Connection Service	W527
14D30000 hex	SQL Execution Failure Log Save Failed	DB Connection Service	W527
14E00000 hex	Invalid GEM Setting Data	GEM Services	W528
14E10000 hex	GEM Service Log Save Failed	GEM Services	W528
14E20000 hex	Spool Data Discarded	GEM Services	W528
14E30000 hex	Spool Save Failed	GEM Services	W528
14E40000 hex	Invalid SD Memory Card	GEM Services	W528
15000000 hex	Execution Log Save Failed	OPC UA Server Function	W503
15020000 hex	Server Certificate Mismatch	OPC UA Server Function	W503
15100000 hex	X Bus Unit Configuration Setting Error	X Bus	W503
15110000 hex	X Bus Unit Backup Failed	X Bus	W503
15120000 hex	X Bus Unit Restore Operation Failed	X Bus	W503
152C0000 hex	Variable Log Save Failed	Errors Related to Controller Operation	W503
17800000 hex	CNC Parameter Setting Error	CNC Function	O030
17810000 hex	Absolute Encoder Home Offset Read Error	CNC Function	O030
17820000 hex	CNC Motor Compensation Table Read Error	CNC Function	O030
17C00000 hex	Robot Control Parameter Setting Error	General Robot Control	O037
17C10000 hex	Remove SD Memory Card with Robot Control Function Enabled	General Robot Control	O037
17C20000 hex	Robot Control Function Enabled without SD Memory Card	General Robot Control	O037
18200000 hex	Absolute Encoder Overspeed Error	Servo G5	I576
18210000 hex	Encoder Initialization Error	Servo G5	I576
18220000 hex	Absolute Encoder One-rotation Counter Error	Servo G5	I576
18230000 hex	Absolute Encoder Multi-rotation Counter Error	Servo G5 and Servo 1S	I576 I586
182D0000 hex	Setting Data Load Error	FH/FZ5 Series Vision System	Z342
18380000 hex	System Error	Servo 1S	I586 I621
18390000 hex	Lifetime Information Corruption Warning	Servo 1S	I586
183A0000 hex	Non-volatile Memory Data Error	Servo 1S	I586 I621
24010000 hex	Unsupported Unit Detected	Errors Related to CJ-series Unit Configuration	W503
24020000 hex	Too Many I/O Points	Errors Related to CJ-series Unit Configuration	W503

Event code	Event name	Functional classification	Reference
24030000 hex	End Cover Missing	Errors Related to CJ-series Unit Configuration	W503
24040000 hex	Incorrect Unit/Expansion Rack Connection	Errors Related to CJ-series Unit Configuration	W503
24050000 hex	Duplicate Unit Number	Errors Related to CJ-series Unit Configuration	W503
24200000 hex	Slave Node Address Duplicated	EtherCAT Master	W503
24400000 hex	Unit Status, Antenna Error	CJ-series ID Sensor Units	Z317
24480000 hex	Node Address Duplicated Error	CJ-series DeviceNet Units	W497
24610000 hex	Switch Setting Error	GX-series EtherCAT Slave Units	W488
24680000 hex	Motor Non-conformity	Servo G5	I576
24690000 hex	Motor Non-conformity	Servo G5	I576
246A0000 hex	Motor Non-conformity	Servo G5	I576
246B0000 hex	Motor Non-conformity	Servo G5	I576
246C0000 hex	Motor Non-conformity	Servo G5	I576
246D0000 hex	Motor Non-conformity	Servo 1S	I586 I621
24780000 hex	Number of Sensors Verify Error	E3X-series Fiber Sensors with EtherCAT Communications Unit for Digital Sensors	E413
24790000 hex	Number of Sensors Over Limit	E3X-series Fiber Sensors with EtherCAT Communications Unit for Digital Sensors	E413
247A 0000 hex	Number of Distributed Sensor Unit Verify Error	EtherCAT Digital Sensor Communications Units	E429
247B 0000 hex	Number of Sensors Over Limit	EtherCAT Digital Sensor Communications Units	E429
247C 0000 hex	Number of Sensors Verify Error	EtherCAT Digital Sensor Communications Units	E429
247D 0000 hex	Number of Sensors Over at Distributed Sensor Unit	EtherCAT Digital Sensor Communications Units	E429
24810000 hex	Ethernet Communications Parameter Error	ZW-CE1□T Confocal Fiber Type Displacement Sensor	Z332
24A00000 hex	Unit Configuration Error, Too Many Units	NX-series EtherCAT Coupler Unit	W519
24A10000 hex	Unit Configuration Error, Unsupported Configuration	NX-series EtherCAT Coupler Unit	W519
24AA0000 hex	Incorrect DIP Switch Setting	NX-series Safety Control Unit	Z930
24C00000 hex	Number of Mountable X Bus Units Exceeded	X Bus	W503
24C10000 hex	Unsupported X Bus Unit Mounted	X Bus	W503
24D00000 hex	Number of Mountable NX Units Exceeded	NX Bus	W503
24D20000 hex	Total I/O Data Size in NX Units Excessive	NX Bus	W503
28010000 hex	Motor Setting Error	G5 Linear	I577
28020000 hex	Motor Combination Error 1	G5 Linear	I577
28030000 hex	Motor Combination Error 2	G5 Linear	I577

Event code	Event name	Functional classification	Reference
28080000 hex	Main Circuit Power Supply Phase Loss Error	Servo 1S	I586 I621
280D0000 hex	Runaway Detected	Servo 1S	I586 I621
30200000 hex	Unsupported Unit Setting	Errors Related to CJ-series Unit Configuration	W503
34010000 hex	I/O Setting Check Error	Errors Related to CJ-series Unit Configuration	W503
34100000 hex	IP Address Table Setting Error	Errors Related to FINS Communications	W503
34110000 hex	Unknown Destination Node	Errors Related to FINS Communications	W503
34130000 hex	FINS/TCP Connection Table Setting Error	Errors Related to FINS Communications	W503
34200000 hex	Tag Data Link Setting Error	EtherNet/IP	W503
34210000 hex	Basic Ethernet Setting Error	EtherNet/IP	W503
34220000 hex	IP Address Setting Error	EtherNet/IP	W503
34230000 hex	IP Route Table Setting Error	EtherNet/IP	W503
34240000 hex	FTP Server Setting Error	EtherNet/IP	W503
34250000 hex	NTP Client Setting Error	EtherNet/IP	W503
34260000 hex	SNMP Setting Error	EtherNet/IP	W503
34270000 hex	Tag Name Resolution Error	EtherNet/IP	W503
34280000 hex	Basic Ethernet Setting Error	EtherNet/IP	W503
34290000 hex	IP Address Setting Error	EtherNet/IP	W503
342A0000 hex	DNS Setting Error	EtherNet/IP	W503
342B0000 hex	Link Setting Not Supported	EtherNet/IP	W503
342C0000 hex	Unit Configuration Error, Combined Use of CIP Safety and Tag Data Link	EtherNet/IP	W627
34400000 hex	Network Configuration Information Error	EtherCAT Master	W503
34410000 hex	EtherCAT Communications Cycle Exceeded	EtherCAT Master	W503
34420000 hex	Parameters Not Transferred	EtherCAT Master	W503
34600000 hex	Required Process Data Object Not Set	General Motion Control	W503
34610000 hex	Process Data Object Setting Missing	Motion Control Instructions	W503
34630000 hex	Axis Slave Disabled	General Motion Control	W503
34640000 hex	Network Configuration Information Missing for Axis Slave	General Motion Control	W503
34800000 hex	Mean Value Processing Setting Error	CJ-series Analog I/O Units	W490
34810000 hex	Input Value Exceeded Adjustment Range in Adjustment Mode	CJ-series Analog I/O Units	W490
34820000 hex	Input Number Specification Error in Adjustment Mode	CJ-series Analog I/O Units	W490
34830000 hex	Scaling Data Setting Error	CJ-series Analog I/O Units	W490

Event code	Event name	Functional classification	Reference
34840000 hex	Input Signal Range Setting Error or Error in Number of Inputs Setting	CJ-series Analog I/O Units	W490
34850000 hex	Mean Value Processing Setting Error	CJ-series Analog I/O Units	W490
34860000 hex	Error in Setting of Conversion Mode	CJ-series Analog I/O Units	W490
34870000 hex	Output Hold Setting Error	CJ-series Analog I/O Units	W490
34880000 hex	Output Number Specification Error in Adjustment Mode	CJ-series Analog I/O Units	W490
34890000 hex	Conversion Time/Resolution or Operation Mode Setting Error	CJ-series Analog I/O Units	W490
348A0000 hex	Output Signal Range Setting Error or Error In Number of Outputs Used Setting	CJ-series Analog I/O Units	W490
348C0000 hex	I/O Number Specification Error in Adjustment Mode	CJ-series Analog I/O Units	W490
348D0000 hex	Data Range Error	CJ-series Process I/O Units	W498
34940000 hex	Setting Error	CJ-series Temperature Control Units	W491
34980000 hex	Results Information, Data Storage Area Specification Error	CJ-series ID Sensor Units	Z317
349C0000 hex	Registration Table Verification Error	CJ-series CompoNet Master Unit	W493
349D0000 hex	Slave Unit Duplicated Address Error	CJ-series CompoNet Master Unit	W493
349E0000 hex	Repeater Unit Node Duplicated Address Error	CJ-series CompoNet Master Unit	W493
34A40000 hex	System Setup Error	CJ-series Serial Communications Units	W494
34A80000 hex	Verification Error	CJ-series EtherNet/IP Units	W495
34A90000 hex	Tag Data Link Error	CJ-series EtherNet/IP Units	W495
34AA0000 hex	Tag Refresh Error	CJ-series EtherNet/IP Units	W495
34AB0000 hex	Basic Ethernet Setting Error	CJ-series EtherNet/IP Units	W495
34AC0000 hex	IP Address Table Error	CJ-series EtherNet/IP Units	W495
34AD0000 hex	IP Router Table Error	CJ-series EtherNet/IP Units	W495
34AE0000 hex	Routing Table Error	CJ-series EtherNet/IP Units	W495
34AF0000 hex	Ethernet Advanced Setting Error	CJ-series EtherNet/IP Units	W495
34B00000 hex	Address Mismatch	CJ-series EtherNet/IP Units	W495
34BC0000 hex	Routing Table Error	CJ-series DeviceNet Units	W497
34BD0000 hex	Verification Error	CJ-series DeviceNet Units	W497
34BE0000 hex	Structure Error	CJ-series DeviceNet Units	W497
34BF0000 hex	Master I/O Refresh Error	CJ-series DeviceNet Units	W497
34C00000 hex	Master User-set Allocations User Setting Failed	CJ-series DeviceNet Units	W497
34C10000 hex	Communications Cycle Time Setting Failed	CJ-series DeviceNet Units	W497
34C20000 hex	Slave I/O Refresh Error	CJ-series DeviceNet Units	W497

Event code	Event name	Functional classification	Reference
34C30000 hex	Slave User Allocation Area Setting Failed	CJ-series DeviceNet Units	W497
34E00000 hex	Data Setting Warning	Servo G5, G5 Linear, and Servo 1S	I576 I577 I586
34E10000 hex	Servo Drive Overheat	Servo G5 and G5 Linear	I576 I577
34E20000 hex	Overload	Servo G5 and G5 Linear	I576 I577
34E30000 hex	Regeneration Overload	Servo G5 and G5 Linear	I576 I577
34E40000 hex	Error Counter Overflow	Servo G5 and G5 Linear	I576 I577
34E50000 hex	Excessive Velocity Error	Servo G5 and G5 Linear	I576 I577
34E60000 hex	Overspeed	Servo G5 and G5 Linear	I576 I577
34F00000 hex	PDO Setting Error	MX2/RX-series Inverters with EtherCAT Communications Units	I574
34F80000 hex	Dummy Sensors Setting Error	E3X-series Fiber Sensors with EtherCAT Communications Unit for Digital Sensors and EtherCAT Digital Sensor Communications Units	E413 E429
35000000 hex	Unit Configuration Information Error	NX-series EtherCAT Coupler Unit	W519
35010000 hex	Unit Configuration Verification Error	NX-series EtherCAT Coupler Unit	W519
35020000 hex	NX Unit Minor Fault	NX-series EtherCAT Coupler Unit	W519
35030000 hex	NX Unit Observation	NX-series EtherCAT Coupler Unit	W519
35040000 hex	Mailbox Setting Error	NX-series EtherCAT Coupler Unit	W519
35050000 hex	RxPDO Setting Error	NX-series EtherCAT Coupler Unit	W519
35060000 hex	TxPDO Setting Error	NX-series EtherCAT Coupler Unit	W519
35070000 hex	PDO WDT Setting Error	NX-series EtherCAT Coupler Unit	W519
35080000 hex	SM Event Mode Setting Error	NX-series EtherCAT Coupler Unit	W519
35090000 hex	TxPDO Mapping Error	NX-series EtherCAT Coupler Unit	W519
350A0000 hex	RxPDO Mapping Error	NX-series EtherCAT Coupler Unit	W519
350B0000 hex	Illegal State Transition Request Received	NX-series EtherCAT Coupler Unit	W519
350C0000 hex	Error State Transition Received	NX-series EtherCAT Coupler Unit	W519

Event code	Event name	Functional classification	Reference
350D0000 hex	Synchronization Cycle Setting Error	NX-series EtherCAT Coupler Unit	W519
350E0000 hex	NX Bus Cycle Delay Detected	NX-series EtherCAT Coupler Unit	W519
35100000 hex	External Input Setting Error	NX-series Position Interface Units	W524
35110000 hex	SSI Data Setting Error	NX-series Position Interface Units	W524
35200000 hex	Safety Process Data Communications Not Established Error	NX-series Safety Control Unit	Z930
35210000 hex	Safety Process Data Communications Not Established - Incorrect Unit Parameter Error	NX-series Safety Control Unit	Z930
35230000 hex	Safety Process Data Communications Not Established, Incorrect FSoE Slave Address Error	NX-series Safety Control Unit	Z930
35240000 hex	Safety Process Data Communications Not Established, Incorrect Frame Error	NX-series Safety Control Unit	Z930
35250000 hex	Safety Unit Restore Operation Failed to Start (SD Memory Card Access Failed)	NX-series Safety Control Unit	Z930
35260000 hex	Safety Unit Restore Operation Failed to Start (Safety Unit Restore File Read Failure)	NX-series Safety Control Unit	Z930
35270000 hex	Safety Unit Restore Operation Failed to Start (Model Mismatch)	NX-series Safety Control Unit	Z930
35280000 hex	Safety Unit Restore Operation Failed to Start (Version Mismatch)	NX-series Safety Control Unit	Z930
35290000 hex	Safety Unit Restore Operation Failed to Start (Node Name Mismatch)	NX-series Safety Control Unit	Z930
352A0000 hex	Safety Unit Restore Operation Failed to Start (Safety Password Mismatch)	NX-series Safety Control Unit	Z930
352B0000 hex	Safety Unit Restore Operation Failed	NX-series Safety Control Unit	Z930
35300000 hex	DB Connection Setting Error	DB Connection Service	W527
35310000 hex	DB Server Certificate Error	DB Connection Service	W527
35400000 hex	Illegal Variable Allocation	GEM Services	W528
35410000 hex	Illegal TCP Port Number	GEM Services	W528
35600000 hex	X Bus Unit Version Not Matched	X Bus	W503
35610000 hex	Unregistered X Bus Unit Mounted	X Bus	W503
35620000 hex	Registered X Bus Unit Not Mounted	X Bus	W503
35630000 hex	X Bus Unit Serial Number Mismatch	X Bus	W503
35680000Hex	I/O Refresh Error	CJ-series EtherCAT Slave Unit	W542
35690000Hex	Mailbox Setting Error	CJ-series EtherCAT Slave Unit	W542

Event code	Event name	Functional classification	Reference
356A0000Hex	Verification Error	CJ-series EtherCAT Slave Unit	W542
356B0000Hex	Illegal State Transition Request Received	CJ-series EtherCAT Slave Unit	W542
356D0000 hex	Parameters Not Transferred	NX Bus	W503
357D0000 hex	DC Setting Error	Servo 1S	1586 1621
357E0000 hex	Synchronization Cycle Setting Error	Servo 1S	1586 1621
357F0000 hex	Mailbox Setting Error	Servo 1S	1586 1621
35800000 hex	RxPDO Setting Error	Servo 1S	1586 1621
35810000 hex	TxPDO Setting Error	Servo 1S	1586 1621
35820000 hex	RxPDO Mapping Error	Servo 1S	1586 1621
35830000 hex	TxPDO Mapping Error	Servo 1S	1586 1621
35840000 hex	PDO WDT Setting Error	Servo 1S	1586 1621
35850000 hex	Node Address Updated	Servo 1S	1586 1621
35860000 hex	SM Event Mode Setting Error	Servo 1S	1586 1621
35900000 hex	NX Unit Version Not Matched	NX Bus	W503
35910000 hex	Unregistered NX Unit Mounted	NX Bus	W503
35920000 hex	Registered NX Unit Not Mounted	NX Bus	W503
35930000 hex	NX Unit Serial Number Mismatch	NX Bus	W503
35940000 hex	Option Board Configuration Verification Error	Built-in I/O and Option Boards	W503
35950000 hex	Unsupported Option Board Mounted	Built-in I/O and Option Boards	W503
35D00000 hex	OPC UA Server Setting Error	OPC UA Server Function	W503
35D10000 hex	Server Certificate Expired	OPC UA Server Function	W503
35D20000 hex	Server Certificate Expiration Notice	OPC UA Server Function	W503
35D30000 hex	Too Many Public Variables	OPC UA Server Function	W503
35D40000 hex	Unsupported Data Type/Invalid Data	OPC UA Server Function	W503
35D50000 hex	Too Many Public Value Attributes	OPC UA Server Function	W503
35D60000 hex	Too Many Structure Definitions	OPC UA Server Function	W503
35EF0000 hex	Automation Playback Startup Error	Errors Related to Controller Operation	W503
36010000 hex	Basic Ethernet Setting Error	NX-series EtherNet/IP Unit	W627
36020000 hex	IP Address Settings Error	NX-series EtherNet/IP Unit	W627
36030000 hex	IP Rout Table Setting Error	NX-series EtherNet/IP Unit	W627
36060000 hex	SNMP Setting Error	NX-series EtherNet/IP Unit	W627

Event code	Event name	Functional classification	Reference
36080000 hex	DNS Setting Error	NX-series EtherNet/IP Unit	W627
37800000 hex	Required Process Data Object Not Set	CNC Function	O030
37810000 hex	Process Data Object Setting Missing	CNC Function	O030
37C20000 hex	Robot Setting Mismatch	General Robot Control	O037
38010000 hex	Scaling Data Setting Error/Ratio Conversion Use Setting Error	CJ-series Analog I/O Units	W490
38020000 hex	Ratio Set Value Error	CJ-series Analog I/O Units	W490
381C0000 hex	Status Area Layout Setting Error	CJ-series EtherNet/IP Units	W495
383C0000 hex	Overload Warning	Servo G5 and G5 Linear	I576 I577
383D0000 hex	Excessive Regeneration Warning	Servo G5 and G5 Linear	I576 I577
383E0000 hex	Vibration Detection Warning	Servo G5 and G5 Linear	I576 I577
383F0000 hex	Excessive Hybrid Following Error	Servo G5	I576
38400000 hex	Overspeed 2	Servo G5 and G5 Linear	I576 I577
38410000 hex	Command Error	Servo G5 and G5 Linear	I576 I577
38420000 hex	Command Generation Error	Servo G5 and G5 Linear	I576 I577
38430000 hex	Error Counter Overflow 1	Servo G5 and G5 Linear	I576 I577
38440000 hex	Error Counter Overflow 2	Servo G5 and G5 Linear	I576 I577
38450000 hex	Interface Input Duplicate Allocation Error 1	Servo G5 and G5 Linear	I576 I577
38460000 hex	Interface Input Duplicate Allocation Error 2	Servo G5 and G5 Linear	I576 I577
38470000 hex	Interface Input Function Number Error 1	Servo G5 and G5 Linear	I576 I577
38480000 hex	Interface Input Function Number Error 2	Servo G5 and G5 Linear	I576 I577
38490000 hex	Interface Output Function Number Error 1	Servo G5 and G5 Linear	I576 I577
384A0000 hex	Interface Output Function Number Error 2	Servo G5 and G5 Linear	I576 I577
384B0000 hex	External Latch Input Allocation Error	Servo G5 and G5 Linear	I576 I577
384C0000 hex	Overrun Limit Error	Servo G5 and G5 Linear	I576 I577
384D0000 hex	Absolute Encoder System Down Error	Servo G5	I576
384E0000 hex	Absolute Encoder Counter Overflow Error	Servo G5	I576
384F0000 hex	Object Setting Error 1	Servo G5 and G5 Linear	I576
38500000 hex	Object Setting Error 2	Servo G5 and G5 Linear	I576

Event code	Event name	Functional classification	Reference
38510000 hex	External Encoder Connection Error	Servo G5 and G5 Linear	I576
38520000 hex	Function Setting Error	Servo G5 and G5 Linear	I576
38530000 hex	Magnetic Pole Position Estimation Error 1	G5 Linear	I577
38540000 hex	Magnetic Pole Position Estimation Error 2	G5 Linear	I577
38550000 hex	Magnetic Pole Position Estimation Error 3	G5 Linear	I577
38560000 hex	Motor Auto-setting Error	G5 Linear	I577
38570000 hex	Function Setting Error	Servo 1S	I586 I621
38590000 hex	Camera Connection Error	FH/FZ5 Series Vision System	Z342
385A0000 hex	Change in Connected Camera	FH/FZ5 Series Vision System	Z342
385B0000 hex	Light installation error	FH/FZ5 Series Vision System	Z342
38780000 hex	General Input Allocation Duplicate Error	Servo 1S	I586 I621
38790000 hex	General Output Allocation Duplicate Error	Servo 1S	I586 I621
387A0000 hex	Overload Warning	Servo 1S	I586
387B0000 hex	Pulse Output Setting Error	Servo 1S	I586 I621
387C0000 hex	Motor Replacement Detected	Servo 1S	I586 I621
387D0000 hex	Regeneration Overload Warning	Servo 1S	I586
387E0000 hex	Motor Vibration Warning	Servo 1S	I586
387F0000 hex	Electronic Gear Setting Error	Servo 1S	I586 I621
38800000 hex	Servo Drive Overheat	Servo 1S	I586 I621
38810000 hex	Overload Error	Servo 1S	I586 I621
38820000 hex	Regeneration Overload Error	Servo 1S	I586 I621
38830000 hex	Excessive Position Deviation Error	Servo 1S	I586 I621
38840000 hex	Excessive Speed Deviation Error	Servo 1S	I586 I621
38850000 hex	Excessive Speed Error	Servo 1S	I586 I621
38860000 hex	Following Error Counter Overflow	Servo 1S	I586 I621
38870000 hex	Absolute Encoder Counter Overflow Error	Servo 1S	I586 I621
38880000 hex	Safety Communications Setting Error	Servo 1S	I586 I621
38890000 hex	Safety Frame Error	Servo 1S	I586 I621
388A0000 hex	Safety Parameter Error	Servo 1S	I586

Event code	Event name	Functional classification	Reference
388B0000 hex	FSoE Slave Address Error	Servo 1S	I586 I621
38980000 hex	Safety Function Setting Error	Servo 1S	I621
38990000 hex	Safety Parameter Error	Servo 1S	I621
39200000Hex	Counter Log Data I/O Allocation Setting Error	NX-series High-speed Counter Units	W647
39210000Hex	Comparison Initial Data Setting Error	NX-series High-speed Counter Units	W647
40010000 hex	PLC System Processing Error	Errors for Self Diagnosis	W503
40020000 hex	PLC System Processing Error	Errors for Self Diagnosis	W503
40030000 hex	PLC System Processing Error	Errors for Self Diagnosis	W503
40040000 hex	PLC System Processing Error	Errors for Self Diagnosis	W503
40050000 hex	PLC System Processing Error	Errors for Self Diagnosis	W503
40110000 hex	PLC Function Processing Error	Errors Related to Controller Operation	W503
40120000 hex	PLC Function Processing Error	Errors Related to Controller Operation	W503
40130000 hex	PLC Function Processing Error	Errors Related to Controller Operation	W503
40140000 hex	PLC System Information	Errors Related to Controller Operation	W503
40150000 hex	PLC System Information	Errors Related to Controller Operation	W503
40160000 hex	Safe Mode	Errors Related to Controller Operation	W503
40170000 hex	Safe Mode	Errors Related to Controller Operation	W503
40200000 hex	NX Unit Processing Error	NX-series EtherCAT Coupler Units, NX-series Analog I/O Units, NX-series Position Interface Units, NX-series Communications Interface Units, NX-series Load Cell Input Units, NX-series IO-Link Master Units, NX-series Temperature Control Units, and NX-series High-speed Counter Units	W519 W566 W524 W540 W565 W570 H228 W647
41000000 hex	X Bus Unit Common Function Processing Error	X Bus Unit	W503
41010000 hex	X Bus Unit Common Function Processing Error	X Bus Unit	W503
41020000 hex	X Bus Unit Common Function Processing Error	X Bus Unit	W503
41030000 hex	X Bus Unit System Information	X Bus Unit	W503
41040000 hex	X Bus Unit System Information	X Bus Unit	W503
41050000 hex	X Bus Unit Common Function Processing Error	X Bus Unit	W503
41060000 hex	X Bus Unit Common Function Processing Error	X Bus Unit	W503
44010000 hex	EtherCAT Fault	EtherCAT Master	W503

Event code	Event name	Functional classification	Reference
44180000 hex	OPC UA System Processing Error	OPC UA Server Function	W503
44190000 hex	OPC UA Server Insufficient Memory Capacity	OPC UA Server Function	W503
441C0000 hex	DB Connection Service System Error	DB Connection Instructions	W527
44200000 hex	Motion Control Initialization Error	General Motion Control	W503
44210000 hex	Motion Control Function Processing Error	General Motion Control	W503
44300000 hex	X Bus Function Processing Error	X Bus	W503
44400000 hex	PLC Function Processing Error	Errors Related to CJ-series Unit Configuration	W503
44410000 hex	PLC System Information	Errors Related to CJ-series Unit Configuration	W503
44420000 hex	PLC Function Processing Error	Errors Related to Controller Operation	W503
44430000 hex	PLC System Information	Errors Related to Controller Operation	W503
44440000 hex	NX Bus Function Processing Error	NX Bus	W503
44450000 hex	NX Bus System Information	NX Bus	W503
47800000 hex	CNC Initialization Error	CNC Function	O030
47810000 hex	CNC Parameter Setting Invalid	CNC Function	O030
47C00000 hex	Robot Control Initialization Error	General Robot Control	O037
47C10000 hex	Robot Control Function Module System Error	General Robot Control	O037
47C20000 hex	Robot Control Function Module Processing Error	General Robot Control	O037
48020000 hex	System Error	FH/FZ5 Series Vision System	Z342
48080000 hex	FPGA WDT Error	Servo 1S	I586 I621
50010000 hex	Controller Insufficient Memory Warning	EtherCAT Master, EtherNet/IP	W503
54010400 hex	Input Value Out of Range	Instructions	W503
54010401 hex	Input Mismatch	Instructions	W503
54010402 hex	Floating-point Error	Instructions	W503
54010403 hex	BCD Error	Instructions	W503
54010404 hex	Signed BCD Error	Instructions	W503
54010405 hex	Illegal Bit Position Specified	Instructions	W503
54010406 hex	Illegal Data Position Specified	Instructions	W503
54010407 hex	Data Range Exceeded	Instructions	W503
54010409 hex	No Errors to Clear	Instructions	W503
5401040B hex	No User Errors to Clear	Instructions	W503
5401040C hex	Limit Exceeded for User-defined Errors	Instructions	W503
5401040D hex	Illegal Unit Specified	Instructions	W503
5401040F hex	Unit Restart Failed	Instructions	W503
54010410 hex	Text String Format Error	Instructions	W503
54010411 hex	Illegal Program Specified	Instructions	W503

Event code	Event name	Functional classification	Reference
54010413 hex	Undefined CJ-series Memory Address	Instructions	W503
54010414 hex	Stack Underflow	Instructions	W503
54010415 hex	Firmware Error	Instructions	W503
54010416 hex	Illegal Number of Array Elements or Dimensions	Instructions	W503
54010417 hex	Specified Task Does Not Exist	Instructions	W503
54010418 hex	Unallowed Task Specification	Instructions	W503
54010419 hex	Incorrect Data Type	Instructions	W503
5401041A hex	Multi-execution of Instructions	Instructions	W503
5401041B hex	Data Capacity Exceeded	Instructions	W503
5401041C hex	Different Data Sizes	Instructions	W503
5401041D hex	Exceeded Simultaneous Instruction Executed Resources	Instructions	W503
54010421 hex	Failed to Get The Program Hash Code	Instructions	W503
54010800 hex	FINS Error	Instructions	W503
54010801 hex	FINS Port Already in Use	Instructions	W503
54010C00 hex	Illegal Serial Communications Mode	Instructions	W503
54010C02 hex	Port Setup Already Busy	Instructions	W503
54010C03 hex	Full Reception Buffer	Instructions	W503
54010C04 hex	Multi-execution of Ports	Instructions	W503
54010C05 hex	Parity Error	Instructions	W503
54010C06 hex	Framing Error	Instructions	W503
54010C07 hex	Overrun Error	Instructions	W503
54010C08 hex	CRC Mismatch	Instructions	W503
54010C0B hex	Serial Communications Timeout	Instructions	W503
54010C0C hex	Instruction Executed to Inapplicable Port	Instructions	W503
54010C0D hex	CIF Unit Initialized	Instructions	W503
54010C10 hex	Exceptional Modbus Response	Instructions	W503
54010C11 hex	Invalid Modbus Response	Instructions	W503
54011400 hex	SD Memory Card Access Failure	Instructions	W503
54011401 hex	SD Memory Card Write-protected	Instructions	W503
54011402 hex	SD Memory Card Insufficient Capacity	Instructions	W503
54011403 hex	File Does Not Exist	Instructions	W503
54011404 hex	Too Many Files/Directories	Instructions	W503
54011405 hex	File Already in Use	Instructions	W503
54011406 hex	Open Mode Mismatch	Instructions	W503
54011407 hex	Offset Out of Range	Instructions	W503
54011408 hex	Directory Not Empty	Instructions	W503
54011409 hex	That File Name Already Exists	Instructions	W503
5401140A hex	Write Access Denied	Instructions	W503
5401140B hex	Too Many Files Open	Instructions	W503



Event code	Event name	Functional classification	Reference
5401140C hex	Directory Does Not Exist	Instructions	W503
5401140D hex	File or Directory Name Is Too Long	Instructions	W503
5401140E hex	SD Memory Card Access Failed	Instructions	W503
5401140F hex	Backup Operation Already in Progress	Instructions	W503
54011410 hex	Cannot Execute Backup	Instructions	W503
54011411 hex	Unit/Slave Backup Failed	Instructions	W503
54011800 hex	EtherCAT Communications Error	Instructions	W503
54011801 hex	EtherCAT Slave Does Not Respond	Instructions	W503
54011802 hex	EtherCAT Timeout	Instructions	W503
54011803 hex	Reception Buffer Overflow	Instructions	W503
54011804 hex	SDO Abort Error	Instructions	W503
54011805 hex	Saving Packet Monitor File	Instructions	W503
54011806 hex	Packet Monitoring Function Not Started	Instructions	W503
54011807 hex	Packet Monitoring Function in Operation	Instructions	W503
54011808 hex	Communications Resource Overflow	Instructions	W503
54011809 hex	Packet Monitoring Function Not Supported	Instructions	W503
5401180A hex	Cannot Execute Instruction for Slave	Instruction	W503
5401180D hex	Diagnosis/Statistics Log Executing	Instructions	W503
5401180E hex	Master Diagnostic and Statistical Information Instruction Multi-execution Disabled	Instructions	W503
5401180F hex	Slave Diagnostic and Statistical Information Instruction Multi-execution Disabled	Instructions	W503
54011C00 hex	Explicit Message Error	Instructions	W503
54011C01 hex	Incorrect Route Path	Instructions	W503
54011C02 hex	CIP Handle Out of Range	Instructions	W503
54011C03 hex	CIP Communications Resource Overflow	Instructions	W503
54011C04 hex	CIP Timeout	Instructions	W503
54011C05 hex	Class-3 Connection Not Established	Instructions	W503
54011C06 hex	CIP Communications Data Size Exceeded	Instructions	W503
54012000 hex	Local IP Address Setting Error	Instructions	W503
54012001 hex	TCP/UDP Port Already in Use	Instructions	W503
54012002 hex	Address Resolution Failed	Instructions	W503
54012003 hex	Socket Status Error	Instructions	W503
54012004 hex	Local IP Address Not Set	Instructions	W503
54012006 hex	Socket Timeout	Instructions	W503

Event code	Event name	Functional classification	Reference
54012007 hex	Socket Handle Out of Range	Instructions	W503
54012008 hex	Socket Communications Resource Overflow	Instructions	W503
5401200A hex	Invalid TLS Session Name	Instructions	W503
5401200B hex	Access to the Certificate Failed	Instructions	W503
5401200C hex	TLS Session Establishment Error	Instructions	W503
5401200E hex	Invalid TLS Session Handle	Instructions	W503
5401200F hex	TLS Error	Instructions	W503
54012400 hex	No Execution Right	Instructions	W503
54012401 hex	Settings Update Failed	Instructions	W503
54012402 hex	Too Many Simultaneous Instruction Executions	Instructions	W503
54012403 hex	FTP Client Execution Limit Exceeded	Instructions	W503
54012404 hex	File Number Limit Exceeded	Instructions	W503
54012405 hex	Directory Does Not Exist (FTP)	Instructions	W503
54012406 hex	FTP Server Connection Error	Instructions	W503
54012407 hex	Destination FTP Server Execution Failure	Instructions	W503
54012408 hex	SD Memory Card Access Failed for FTP	Instructions	W503
54012409 hex	Specified File Does Not Exist	Instructions	W503
5401240A hex	Specified File Is Write Protected	Instructions	W503
5401240B hex	Failed To Delete Specified File	Instructions	W503
5401240C hex	Specified File Access Failed	Instructions	W503
5401240D hex	IP Address Setting Invalid	Instructions	W503
54012C00 hex	NX Message Error	Instructions	W503
54012C01 hex	NX Message Resource Overflow	Instructions	W503
54012C02 hex	NX Message Timeout	Instructions	W503
54012C03 hex	Incorrect NX Message Length	Instructions	W503
54012C05 hex	NX Message EtherCAT Network Error	Instructions	W503
54012C06 hex	External Restart Already Executed for Specified NX Units	Instructions	W503
54012C07 hex	Unapplicable Unit Specified for Instruction	Instructions	W503
54012C08 hex	Invalid Total Power ON Time Record	Instructions	W503
54013000 hex	DB Connection Service Not Started	DB Connection Instructions	W527
54013001 hex	DB Connection Service Run Mode Change Failed	DB Connection Instructions	W527
54013002 hex	DB Connection Service Shutdown or Shutting Down	DB Connection Instructions	W527
54013003 hex	Invalid DB Connection Name	DB Connection Instructions	W527
54013004 hex	DB Connection Rejected	DB Connection Instructions	W527
54013005 hex	DB Connection Failed	DB Connection Instructions	W527

Event code	Event name	Functional classification	Reference
54013006 hex	DB Connection Already Established	DB Connection Instructions	W527
54013007 hex	Too Many DB Connections	DB Connection Instructions	W527
54013008 hex	Invalid DB Connection	DB Connection Instructions	W527
54013009 hex	Invalid DB Map Variable	DB Connection Instructions	W527
5401300A hex	Unregistered DB Map Variable	DB Connection Instructions	W527
5401300B hex	SQL Execution Error	DB Connection Instructions	W527
5401300C hex	Spool Capacity Exceeded	DB Connection Instructions	W527
5401300E hex	Invalid Extraction Condition	DB Connection Instructions	W527
54013010 hex	Log Code Out of Range	DB Connection Instructions	W527
54013011 hex	DB Connection Disconnected Error Status	DB Connection Instructions	W527
54013012 hex	DB Connection Instruction Execution Timeout	DB Connection Instructions	W527
54013013 hex	DB Connection Service Error Stop	DB Connection Instructions	W527
54013014 hex	Data Already Spooled	DB Connection Instructions	W527
54013015 hex	DB Connection Service Initializing	DB Connection Instructions	W527
54013016 hex	DB in Process	DB Connection Instructions	W527
54013017 hex	Operation Log Disabled	DB Connection Instructions	W527
54013018 hex	Invalid Procedure Handle	DB Connection Instructions	W527
54013019 hex	Instruction Executed for Unsupported Database Type	DB Connection Instructions	W527
5401301A hex	Invalid Stored Procedure Name	DB Connection Instructions	W527
5401301B hex	Invalid Stored Procedure Argument	DB Connection Instructions	W527
5401301C hex	Invalid Number of Columns for Stored Procedure Result Set	DB Connection Instructions	W527
5401301E hex	DB Connection Service Not Used	DB Connection Instructions	W527
54013461 hex	Process Data Object Setting Missing	Instructions	W503
54013781 hex	Process Data Object Setting Missing	CNC Instructions	O030
54013810 hex	GEM Service Status in Initializing	GEM Instructions	W528
54013811 hex	GEM Service Status in EQStarting	GEM Instructions	W528
54013812 hex	GEM Service Status in EQInitializing	GEM Instructions	W528
54013813 hex	GEM Service Status in EQRun	GEM Instructions	W528
54013814 hex	GEM Service Status in Stop	GEM Instructions	W528
54013815 hex	GEM Service Status in Error	GEM Instructions	W528
54013816 hex	GEM Service Status in Shutting-Down	GEM Instructions	W528
54013817 hex	GEM Service Status in Shut-down	GEM Instructions	W528
54013818 hex	No Message Received	GEM Instructions	W528

Event code	Event name	Functional classification	Reference
54013819 hex	Multi-execution of Instructions	GEM Instructions	W528
5401381A hex	State Transition in Progress	GEM Instructions	W528
5401381B hex	Insufficient Transaction Resource	GEM Instructions	W528
54013820 hex	Too Many Characters	GEM Instructions	W528
54013821 hex	Invalid Size	GEM Instructions	W528
54013822 hex	Set to Disable	GEM Instructions	W528
54013824 hex	Undefined CEID	GEM Instructions	W528
54013825 hex	Undefined ALID	GEM Instructions	W528
54013826 hex	Undefined CCODE	GEM Instructions	W528
54013827 hex	Undefined Message Number	GEM Instructions	W528
54013828 hex	HSMS Communications Setting Out of Range	GEM Instructions	W528
54013829 hex	TID Out of Range	GEM Instructions	W528
5401382C hex	Undefined ECID	GEM Instructions	W528
5401382D hex	Type Mismatch	GEM Instructions	W528
5401382E hex	ECV Out of Range	GEM Instructions	W528
5401382F hex	Illegal CPNAME	GEM Instructions	W528
54013830 hex	HACK Out of Range	GEM Instructions	W528
54013831 hex	CPACK Out of Range	GEM Instructions	W528
54013832 hex	CEPACK Out of Range	GEM Instructions	W528
54013833 hex	ACKC7 Out of Range	GEM Instructions	W528
54013834 hex	ACKC7A Out of Range	GEM Instructions	W528
54013835 hex	ACKC10 Out of Range	GEM Instructions	W528
54013836 hex	EAC Out of Range	GEM Instructions	W528
54013838 hex	Illegal SECS Message	GEM Instructions	W528
54014800 hex	Device Error Received	Instructions	W503
54014801 hex	Specified Unit Does Not Exist	Instructions	W503
54014802 hex	Message Processing Limit Exceeded	Instructions	W503
54014803 hex	Specified Unit Status Error	Instructions	W503
54014804 hex	Too Many Simultaneous Instruction Executions	Instructions	W503
54014805 hex	Communications Timeout	Instructions	W503
54014806 hex	Invalid Mode	Instructions	W503
54014807 hex	I/O Power OFF Status	Instructions	W503
54014808 hex	Verification Error	Instructions	W503
54014809 hex	Incorrect Device Port Setting	Instructions	W503
54015000 hex	OPC UA Server Shutdown or Shutting Down	OPC UA Instructions	W503
54015001 hex	OPC UA Server Being Initialized	OPC UA Instructions	W503
54015002 hex	OPC UA Server Not Started	OPC UA Instructions	W503
54015420 hex	Electronic Gear Ratio Numerator Setting Out of Range	Instructions	W503
54015421 hex	Electronic Gear Ratio Denominator Setting Out of Range	Instructions	W503
54015422 hex	Target Velocity Setting Out of Range	Instructions and Robot Instructions	W503 W539

Event code	Event name	Functional classification	Reference
54015423 hex	Acceleration Setting Out of Range	Instructions and Robot Instructions	W503 W539
54015424 hex	Deceleration Setting Out of Range	Instructions and Robot Instructions	W503 W539
54015425 hex	Jerk Setting Out of Range	Instructions	W503
54015427 hex	Torque Ramp Setting Out of Range	Instructions	W503
54015428 hex	Master Coefficient Scaling Out of Range	Instructions	W503
54015429 hex	Slave Coefficient Scaling Out of Range	Instructions	W503
5401542A hex	Feeding Velocity Setting Out of Range	Instructions	W503
5401542B hex	Buffer Mode Selection Out of Range	Instructions and Robot Instructions	W503 W539
5401542C hex	Coordinate System Selection Out of Range	Instructions and Robot Instructions	W503 W539
5401542D hex	Circular Interpolation Mode Selection Out of Range	Instructions	W503
5401542E hex	Direction Selection Out of Range	Instructions and Robot Instructions	W503 W539
5401542F hex	Path Selection Out of Range	Instructions	W503
54015430 hex	Position Type Selection Out of Range	Instructions	W503
54015431 hex	Travel Mode Selection Out of Range	Instructions	W503
54015432 hex	Transition Mode Selection Out of Range	Instructions and Robot Instructions	W503 W539
54015433 hex	Continue Method Selection Out of Range	Instructions	W503
54015434 hex	Combine Mode Selection Out of Range	Instructions	W503
54015435 hex	Synchronization Start Condition Selection Out of Range	Instructions	W503
54015436 hex	Master and Slave Defined as Same Axis	Instructions	W503
54015437 hex	Master and Auxiliary Defined as Same Axis	Instructions	W503
54015438 hex	Master/Slave Axis Numbers Not in Ascending Order	Instructions	W503
54015439 hex	Incorrect Cam Table Specification	Instructions	W503
5401543A hex	Synchronization Stopped	Instructions	W503
5401543B hex	Motion Control Instruction Re-execution Disabled	Instructions and Robot Instructions	W503 W539
5401543C hex	Motion Control Instruction Multi-execution Disabled	Instructions and Robot Instructions	W503 W539
5401543D hex	Instruction Not Allowed for Encoder Axis Type	Instructions	W503

Event code	Event name	Functional classification	Reference
5401543E hex	Instruction Cannot Be Executed during Multi-axes Coordinated Control	Instructions and Robot Instructions	W503 W539
5401543F hex	Multi-axes Coordinated Control Instruction Executed for Disabled Axes Group	Instructions and Robot Instructions	W503 W539
54015440 hex	Axes Group Cannot Be Enabled	Instructions	W503
54015441 hex	Impossible Axis Operation Specified when the Servo is OFF	Instructions and Robot Instructions	W503 W539
54015442 hex	Composition Axis Stopped Error	Instructions and Robot Instructions	W503 W539
54015443 hex	Motion Control Instruction Multi-execution Buffer Limit Exceeded	Instructions and Robot Instructions	W503 W539
54015444 hex	Insufficient Travel Distance	Instructions	W503
54015445 hex	Insufficient Travel Distance to Achieve Blending Transit Velocity	Instructions	W503
54015446 hex	Move Link Constant Velocity Insufficient Travel Distance	Instructions	W503
54015447 hex	Positioning Gear Operation Insufficient Target Velocity	Instructions	W503
54015448 hex	Same Start Point and End Point for Circular Interpolation	Instructions	W503
54015449 hex	Circular Interpolation Center Specification Position Out of Range	Instructions	W503
5401544A hex	Instruction Execution Error Caused by Count Mode Setting	Instructions	W503
5401544C hex	Parameter Selection Out of Range	Instructions	W503
5401544D hex	Stop Method Selection Out of Range	Instructions	W503
5401544E hex	Latch ID Selection Out of Range for Trigger Input Condition	Instructions	W503
5401544F hex	Setting Out of Range for Writing MC Setting	Instructions	W503
54015450 hex	Trigger Input Condition Mode Selection Out of Range	Instructions	W503
54015451 hex	Drive Trigger Signal Selection Out of Range for Trigger Input Condition	Instructions	W503
54015453 hex	Motion Control Instruction Re-execution Disabled (Axis Specification)	Instructions	W503
54015454 hex	Motion Control Instruction Re-execution Disabled (Buffer Mode Selection)	Instructions	W503
54015455 hex	Motion Control Instruction Re-execution Disabled (Direction Selection)	Instructions	W503

Event code	Event name	Functional classification	Reference
54015456 hex	Motion Control Instruction Re-execution Disabled (Execution Mode)	Instructions	W503
54015457 hex	Motion Control Instruction Re-execution Disabled (Axes Group Specification)	Instructions	W503
54015458 hex	Motion Control Instruction Re-execution Disabled (Jerk Setting)	Instructions	W503
54015459 hex	Motion Control Instruction Re-execution Disabled (Master Axis)	Instructions	W503
5401545A hex	Motion Control Instruction Re-execution Disabled (MasterOffset)	Instructions	W503
5401545B hex	Motion Control Instruction Re-execution Disabled (MasterScaling)	Instructions	W503
5401545C hex	Motion Control Instruction Re-execution Disabled (MasterStartDistance)	Instructions	W503
5401545D hex	Motion Control Instruction Re-execution Disabled (Continuous)	Instructions	W503
5401545E hex	Motion Control Instruction Re-execution Disabled (MoveMode)	Instructions	W503
5401545F hex	Illegal Auxiliary Axis Specification	Instructions	W503
54015460 hex	Illegal Axis Specification	Instructions	W503
54015461 hex	Illegal Axes Group Specification	Instructions and Robot Instructions	W503 W539
54015462 hex	Illegal Master Axis Specification	Instructions	W503
54015463 hex	Motion Control Instruction Re-execution Disabled (SlaveOffset)	Instructions	W503
54015464 hex	Motion Control Instruction Re-execution Disabled (SlaveScaling)	Instructions	W503
54015465 hex	Motion Control Instruction Re-execution Disabled (StartPosition)	Instructions	W503
54015466 hex	Instruction Execution Error with Undefined Home	Instructions and Robot Instructions	W503 W539
54015467 hex	Motion Control Instruction Re-execution Disabled (Position Type)	Instructions	W503
54015468 hex	Unused Axis Specification for Master Axis	Instructions	W503
54015469 hex	First Position Setting Out of Range	Instructions	W503
5401546A hex	Last Position Setting Out of Range	Instructions	W503

Event code	Event name	Functional classification	Reference
5401546B hex	Illegal First/Last Position Size Relationship (Linear Mode)	Instructions	W503
5401546C hex	Master Sync Start Position Setting Out of Range	Instructions	W503
5401546D hex	Slave Sync Start Position Setting Out of Range	Instructions	W503
5401546E hex	Duplicate Latch ID for Trigger Input Condition	Instructions	W503
5401546F hex	Jerk Override Factor Out of Range	Instructions	W503
54015470 hex	Acceleration/Deceleration Override Factor Out of Range	Instructions	W503
54015471 hex	First Position Method Specification Out of Range	Instructions	W503
54015472 hex	Motion Control Instruction Re-execution Disabled (First Position Method)	Instructions	W503
54015474 hex	Unused Axis Specification for Auxiliary Axis	Instructions	W503
54015475 hex	Position Gear Value Error	Instructions	W503
54015476 hex	Position Gear Master Axis Zero Velocity	Instructions	W503
54015478 hex	Target Position Setting Out of Range	Instructions and Robot Instructions	W503 W539
54015479 hex	Travel Distance Out of Range	Instructions	W503
5401547A hex	Cam Table Start Point Setting Out of Range	Instructions	W503
5401547B hex	Cam Master Axis Following First Position Setting Out of Range	Instructions	W503
5401547C hex	Circular Interpolation Radius Setting Error	Instructions	W503
5401547D hex	Circular Interpolation Radius Overflow	Instructions	W503
5401547E hex	Circular Interpolation Setting Out of Range	Instructions	W503
5401547F hex	Auxiliary/Slave Axis Numbers Not in Ascending Order	Instructions	W503
54015480 hex	Cam Table Property Ascending Data Error at Update	Instructions	W503
54015481 hex	MC_Write Target Out of Range	Instructions	W503
54015482 hex	Master Travel Distance Specification Out of Range	Instructions	W503
54015483 hex	Master Distance in Acceleration Specification Out of Range	Instructions	W503
54015484 hex	Master Distance in Deceleration Specification Out of Range	Instructions	W503
54015487 hex	Execution Mode Selection Out of Range	Instructions	W503
54015488 hex	Permitted Following Error Out of Range	Instructions	W503

Event code	Event name	Functional classification	Reference
54015489 hex	Border Point/Center Position/ Radius Specification Out of Range	Instructions	W503
5401548A hex	End Point Specification Out of Range	Instructions	W503
5401548B hex	Slave Travel Distance Specifica- tion Out of Range	Instructions	W503
5401548C hex	Phase Shift Amount Out of Range	Instructions	W503
5401548D hex	Feeding Distance Out of Range	Instructions	W503
5401548E hex	Auxiliary and Slave Defined as Same Axis	Instructions	W503
5401548F hex	Relative Position Selection Out of Range	Instructions	W503
54015490 hex	Cam Transition Specification Out of Range	Instructions	W503
54015491 hex	Synchronized Control End Mode Selection Out of Range	Instructions	W503
54015492 hex	Enable External Latch Instruc- tion Execution Disabled	Instructions	W503
54015493 hex	Master Axis Offset Out of Range	Instructions	W503
54015494 hex	Slave Axis Offset Out of Range	Instructions	W503
54015495 hex	Command Current Position Count Selection Out of Range	Instructions	W503
54015496 hex	Master Axis Gear Ratio Numerator Out of Range	Instructions	W503
54015497 hex	Master Axis Gear Ratio Denomi- nator Out of Range	Instructions	W503
54015498 hex	Auxiliary Axis Gear Ratio Nu- merator Out of Range	Instructions	W503
54015499 hex	Auxiliary Axis Gear Ratio De- nominator Out of Range	Instructions	W503
5401549A hex	Master Axis Position Type Se- lection Out of Range	Instructions	W503
5401549B hex	Auxiliary Axis Position Type Se- lection Out of Range	Instructions	W503
5401549C hex	Target Position Ring Counter Out of Range	Instructions	W503
5401549D hex	Axes Group Composition Axis Setting Out of Range	Instructions	W503
5401549E hex	Axis Use Setting Out of Range	Instructions	W503
54015510 hex	Robot Control Instruction Re-ex- ecution Disabled	Robot Control Instructions	O037
54015511 hex	V+ Task Number Setting Out of Range	Robot Control Instructions	O037
54015512 hex	Illegal Robot Specification	Robot Control Instructions	O037
54015513 hex	Illegal Parameter List Specifica- tion	Robot Control Instructions	O037
54015514 hex	Starting Step Setting Out of Range	Robot Control Instructions	O037

Event code	Event name	Functional classification	Reference
54015515 hex	Target Position Setting Out of Range	Robot Control Instructions	O037
54015516 hex	Lefty and Righty Setting Out of Range	Robot Control Instructions	O037
54015517 hex	Above and Below Setting Out of Range	Robot Control Instructions	O037
54015518 hex	Flip Setting Out of Range	Robot Control Instructions	O037
54015519 hex	Velocity Profile Selection Out of Range	Robot Control Instructions	O037
5401551A hex	Velocity Mode Selection Out of Range	Robot Control Instructions	O037
5401551B hex	Velocity Ratio Setting Out of Range	Robot Control Instructions	O037
5401551C hex	Rotation Velocity Ratio Setting Out of Range	Robot Control Instructions	O037
5401551D hex	Velocity Setting Out of Range	Robot Control Instructions	O037
5401551E hex	Acceleration Ratio Setting Out of Range	Robot Control Instructions	O037
5401551F hex	Deceleration Ratio Setting Out of Range	Robot Control Instructions	O037
54015520 hex	Positioning Accuracy Selection Out of Range	Robot Control Instructions	O037
54015521 hex	Rotation Limit Selection Out of Range	Robot Control Instructions	O037
54015522 hex	Buffer Mode Selection Out of Range	Robot Control Instructions	O037
54015523 hex	Target Position Specification Method Setting Out of Range	Robot Control Instructions	O037
54015533 hex	Robot Control Instruction Executed while Robot is not Attached	Robot Control Instructions	O037
54015535 hex	Tool Coordination Transform Setting Out of Range	Robot Control Instructions	O037
54015536 hex	Robot Control Instruction Multi-execution Disabled	Robot Control Instructions	O037
5401553C hex	Robot Control Instruction Multi-execution Buffer Limit Exceeded	Robot Control Instructions	O037
5401553D hex	Robot Control Instruction Executed with Calibration Not Completed	Robot Control Instructions	O037
5401553E hex	Robot Control Instruction Executed while Robot High Power is OFF	Robot Control Instructions	O037
5401553F hex	Robot Already Attached	Robot Control Instructions	O037
54015540 hex	Robot Control Instruction Executed while Robot is MANUAL Mode or is not COMP Mode	Robot Control Instructions	O037
54015544 hex	Cannot Execute Robot Control Instruction	Robot Control Instructions	O037
54015548 hex	Illegal Program Name Specification	Robot Control Instructions	O037

Event code	Event name	Functional classification	Reference
54015600 hex	Illegal CNC Coordinate System Specification	CNC Instructions	O030
54015601 hex	Deceleration Setting Out of Range	CNC Instructions	O030
54015602 hex	Jerk Setting Out of Range	CNC Instructions	O030
54015603 hex	CNC Instruction Re-execution Disabled	CNC Instructions	O030
54015604 hex	CNC Multi-execution Disabled	CNC Instructions	O030
54015605 hex	Unassigned Logical CNC Motor Number Specified	CNC Instructions	O030
54015606 hex	Logical CNC Motor Number Out of Range	CNC Instructions	O030
54015607 hex	Target Position Setting Out of Range	CNC Instructions	O030
54015608 hex	Impossible CNC Motor Operation Specified when the Servo is OFF	CNC Instructions	O030
54015609 hex	Target Velocity Setting Out of Range	CNC Instructions	O030
5401560A hex	Acceleration/Deceleration Setting Out of Range	CNC Instructions	O030
5401560B hex	Travel Mode Selection Out of Range	CNC Instructions	O030
5401560D hex	Parameter Selection Out of Range	CNC Instructions	O030
5401560E hex	CNC Parameter Setting Read/Write Setting Value Out of Range	CNC Instructions	O030
5401560F hex	CNC Parameter Setting Read/Write Target Out of Range	CNC Instructions	O030
54015611 hex	Homing Parameter Setting Out of Range	CNC Instructions	O030
54015612 hex	M Code Number Out of Range	CNC Instructions	O030
54015613 hex	CNC Instruction Re-execution Disabled (CNC Coordinate System Specification)	CNC Instructions	O030
54015614 hex	CNC Instruction Re-execution Disabled (Logical CNC Motor Number)	CNC Instructions	O030
5401561D hex	SD Memory Card Access Failure	CNC Instructions	O030
5401561E hex	File Does Not Exist	CNC Instructions	O030
5401561F hex	Illegal Load NC Program Number Specification	CNC Instructions	O030
54015620 hex	Too Many Files Open	CNC Instructions	O030
54015621 hex	File or Directory Name Is Too Long	CNC Instructions	O030
54015622 hex	SD Memory Card Access Failed	CNC Instructions	O030
54015623 hex	Load NC Program Capacity Exceeded	CNC Instructions	O030

Event code	Event name	Functional classification	Reference
54015624 hex	Number of NC Program Exceeded	CNC Instructions	O030
54015625 hex	Illegal CNC Motor Specification	CNC Instructions	O030
54015626 hex	Illegal CNC Motor Compensation Table Specification	CNC Instructions	O030
54015628 hex	Illegal Load NC Program	CNC Instructions	O030
54015700 hex	Homing Parameter Setting Out of Range	Instructions	W503
54015702 hex	Axis Use Change Error	Instructions	W503
54015703 hex	Cannot Change Axis Use	Instructions	W503
54015706 hex	Axes Group Mismatch with Kinematics	Robot Instructions	W539
54015707 hex	Kinematics Type Out of Range	Robot Instructions	W539
54015708 hex	Kinematics Parameter Out of Range	Robot Instructions	W539
54015709 hex	Workspace Type Out of Range	Robot Instructions	W539
5401570A hex	Workspace Parameter Out of Range	Robot Instructions	W539
5401570B hex	Invalid Coordinate System Number	Robot Instructions	W539
5401570C hex	Coordinate Transformation Parameter Out of Range	Robot Instructions	W539
5401570D hex	Transition parameters out of range	Robot Instructions	W539
54015710 hex	Kinematics Transform Not Set	Robot Instructions	W539
54015711 hex	Target Position Out of Range	Robot Instructions	W539
54015712 hex	Velocity Error Detection Value Out of Range	Robot Instructions	W539
54015713 hex	Acceleration Error Detection Value Out of Range	Robot Instructions	W539
54015714 hex	Trajectory Target Time Out of Range	Robot Instructions	W539
54015715 hex	Trajectory Type Out of Range	Robot Instructions	W539
54015716 hex	Trajectory Transition Out of Range	Robot Instructions	W539
54015717 hex	Trajectory Travel Distance Out of Range	Robot Instructions	W539
54015719 hex	Initial Workpiece Position Outside Workspace	Robot Instructions	W539
5401571A hex	Invalid Conveyor Axis Specified	Robot Instructions	W539
5401571B hex	Target Position Outside Workspace	Robot Instructions	W539
5401571C hex	Cannot Cancel Synchronization	Robot Instructions	W539
5401571E hex	Too Many Kinematics	Robot Instructions	W539
5401571F hex	Kinematics Initialization Error	Robot Instructions	W539
54015720 hex	Motion Control Parameter Setting Error When Changing Axis Use	Instructions	W503

Event code	Event name	Functional classification	Reference
54015721 hex	Required Process Data Object Not Set When Changing Axis Use	Instructions	W503
54015722 hex	Actual Position Overflow/Underflow	Instructions	W503
54015723 hex	Switch Structure Track Number Setting Out of Range	Instructions	W503
54015724 hex	Switch Structure First ON Position Setting Out of Range	Instructions	W503
54015725 hex	Switch Structure Last ON Position Setting Out of Range	Instructions	W503
54015726 hex	Switch Structure Axis Direction Out of Range	Instructions	W503
54015727 hex	Switch Structure Cam Switch Mode Out of Range	Instructions	W503
54015728 hex	Switch Structure Duration Setting Out of Range	Instructions	W503
54015729 hex	Track Option Structure ON Compensation Setting Out of Range	Instructions	W503
5401572A hex	Track Option Structure OFF Compensation Setting Out of Range	Instructions	W503
5401572B hex	Number of Array Elements in Switch Structure Variable Out of Range	Instructions	W503
5401572C hex	Number of Array Elements in Output Signal Structure Variable Out of Range	Instructions	W503
5401572D hex	Number of Array Elements in Track Option Structure Variable Out of Range	Instructions	W503
5401572E hex	Numbers of Elements in Output Signals and Track Option Arrays Not Matched	Instructions	W503
5401572F hex	Motion Control Instruction Multi-execution Disabled (Master Axis)	Instructions	W503
54015730 hex	Motion Control Instruction Multi-execution Disabled (Position Type Selection)	Instructions	W503
54015731 hex	Same Track Number Setting in Switch Structure Out of Range	Instructions	W503
54015732 hex	Invalid Tool Number	Robot Instructions	W539
54015733 hex	Tool Parameter Out of Range	Robot Instructions	W539
54015736 hex	Offset Not Allowed	Robot Instructions	W539
5401573A hex	Cannot Write Axis Parameters	Instructions	W503
5401573B hex	Axis Parameter Setting Out of Range	Instructions	W503
5401573C hex	Cam Property Setting Out of Range	Instructions	W503
5401573D hex	Cam Node Setting Out of Range	Instructions	W503

Event code	Event name	Functional classification	Reference
5401573E hex	Incorrect Cam Node Type Specification	Instructions	W503
5401573F hex	Insufficient Nodes in Cam Table	Instructions	W503
54015740 hex	Cam Node Master Axis Phase Not in Ascending Order	Instructions	W503
54015741 hex	Too Many Data Points in Cam Table	Instructions	W503
54015742 hex	Cam Table Displacement Overflow	Instructions	W503
54015743 hex	Aborted Cam Table Used	Instructions	W503
54015744 hex	Jog Mode Out of Range	Robot Instructions	W539
54015745 hex	Initial Workpiece Position Out of Range	Robot Instructions	W539
54015746 hex	Maximum Interpolation Velocity Out of Range	Robot Instructions	W539
54015747 hex	Maximum Interpolation Acceleration Out of Range	Robot Instructions	W539
54015748 hex	Maximum Interpolation Deceleration Out of Range	Robot Instructions	W539
54015749 hex	Execution ID Setting Out of Range	Instructions	W503
5401574A hex	Position Offset Out of Range	Instructions	W503
5401574B hex	PDS State Transition Command Selection Out of Range	Instructions	W503
5401574C hex	Single-axis Position Control Axis Motion Control Instruction Execution Disabled	Instructions	W503
54015751 hex	Cam Monitor Mode Selection Out of Range	Instructions	W503
54015752 hex	Data Type of Cam Monitor Values Mismatch	Instructions	W503
54015753 hex	Sync Mode Setting Out of Range	Instructions	W503
54015754 hex	Gear Master Axis Following First Position Setting Out of Range	Instructions	W503
54015755 hex	Torque Limit Mode Setting Out of Range	Instructions	W503
54015756 hex	Insufficient Cam Nodes	Instructions	W503
54015757 hex	Cam Node Start Point Position Out of Range	Instructions	W503
54015758 hex	Cam Operation Displacement Overflow	Instructions	W503
54015759 hex	Reversing Operation Not Possible	Instructions	W503
54015800 hex	X Bus Unit Does Not Exist	Instructions	W503
54015801 hex	Response Timeout	Instructions	W503
54015C00 hex	Cannot Execute at Specified Unit/Port	Instructions	W503
54015C01 hex	Too Many Simultaneous Instruction Executions	Instructions	W503

Event code	Event name	Functional classification	Reference
54015C03 hex	Target Node IP Address Does Not Exist	Instructions	W503
54015C04 hex	Connection Communications Error	Instructions	W503
54015C05 hex	Connection Setting Error	Instructions	W503
54016440 hex	Target Position Positive Software Limit Exceeded	Instructions	W503
54016441 hex	Target Position Negative Software Limit Exceeded	Instructions	W503
54016442 hex	Command Position Overflow/Underflow	Instructions	W503
54016443 hex	Positive Limit Input	Instructions and Robot Instructions	W503 W539
54016444 hex	Negative Limit Input	Instructions and Robot Instructions	W503 W539
54016701 hex	Current Position Outside Workspace	Robot Instructions	W539
54016783 hex	Target Position Positive Software Limit Exceeded	CNC Instructions	O030
54016784 hex	Target Position Negative Software Limit Exceeded	CNC Instructions	O030
54016785 hex	Command Position Overflow/Underflow	CNC Instructions	O030
54016786 hex	Positive Limit Input	CNC Instructions	O030
54016787 hex	Negative Limit Input	CNC Instructions	O030
54017422 hex	Servo Main Circuits OFF	Instructions	W503
54017784 hex	Servo Main Circuits OFF	CNC Instructions	O030
54200000 hex	Electronic Gear Ratio Numerator Setting Out of Range	Motion Control Instructions	W503
54210000 hex	Electronic Gear Ratio Denominator Setting Out of Range	Motion Control Instructions	W503
54220000 hex	Target Velocity Setting Out of Range	Motion Control Instructions NJ Robotics Function	W503 W539
54230000 hex	Acceleration Setting Out of Range	Motion Control Instructions NJ Robotics Function	W503 W539
54240000 hex	Deceleration Setting Out of Range	Motion Control Instructions NJ Robotics Function	W503 W539
54250000 hex	Jerk Setting Out of Range	Motion Control Instructions	W503
54270000 hex	Torque Ramp Setting Out of Range	Motion Control Instructions	W503
54280000 hex	Master Coefficient Scaling Out of Range	Motion Control Instructions	W503
54290000 hex	Slave Coefficient Scaling Out of Range	Motion Control Instructions	W503
542A0000 hex	Feeding Velocity Setting Out of Range	Motion Control Instructions	W503
542B0000 hex	Buffer Mode Selection Out of Range	Motion Control Instructions NJ Robotics Function	W503 W539
542C0000 hex	Coordinate System Selection Out of Range	Motion Control Instructions NJ Robotics Function	W503 W539

Event code	Event name	Functional classification	Reference
542D0000 hex	Circular Interpolation Mode Selection Out of Range	Motion Control Instructions	W503
542E0000 hex	Direction Selection Out of Range	Motion Control Instructions NJ Robotics Function	W503 W539
542F0000 hex	Path Selection Out of Range	Motion Control Instructions	W503
54300000 hex	Position Type Selection Out of Range	Motion Control Instructions	W503
54310000 hex	Travel Mode Selection Out of Range	Motion Control Instructions	W503
54320000 hex	Transition Mode Selection Out of Range	Motion Control Instructions NJ Robotics Function	W503 W539
54330000 hex	Continue Method Selection Out of Range	Motion Control Instructions	W503
54340000 hex	Combine Mode Selection Out of Range	Motion Control Instructions	W503
54350000 hex	Synchronization Start Condition Selection Out of Range	Motion Control Instructions	W503
54360000 hex	Master and Slave Defined as Same Axis	Motion Control Instructions	W503
54370000 hex	Master and Auxiliary Defined as Same Axis	Motion Control Instructions	W503
54380000 hex	Master/Slave Axis Numbers Not in Ascending Order	Motion Control Instructions	W503
54390000 hex	Incorrect Cam Table Specification	Motion Control Instructions	W503
543A0000 hex	Synchronization Stopped	Motion Control Instructions	W503
543B0000 hex	Motion Control Instruction Re-execution Disabled	Motion Control Instructions NJ Robotics Function	W503 W539
543C0000 hex	Motion Control Instruction Multi-execution Disabled	Motion Control Instructions NJ Robotics Function	W503 W539
543D0000 hex	Instruction Not Allowed for Encoder Axis Type	Motion Control Instructions	W503
543E0000 hex	Instruction Cannot Be Executed during Multi-axes Coordinated Control	Motion Control Instructions NJ Robotics Function	W503 W539
543F0000 hex	Multi-axes Coordinated Control Instruction Executed for Disabled Axes Group	Motion Control Instructions NJ Robotics Function	W503 W539
54400000 hex	Axes Group Cannot Be Enabled	Motion Control Instructions	W503
54410000 hex	Impossible Axis Operation Specified when the Servo is OFF	Motion Control Instructions NJ Robotics Function	W503 W539
54420000 hex	Composition Axis Stopped Error	Motion Control Instructions NJ Robotics Function	W503 W539
54430000 hex	Motion Control Instruction Multi-execution Buffer Limit Exceeded	Motion Control Instructions NJ Robotics Function	W503 W539
54440000 hex	Insufficient Travel Distance	Motion Control Instructions	W503
54450000 hex	Insufficient Travel Distance to Achieve Blending Transit Velocity	Motion Control Instructions	W503

Event code	Event name	Functional classification	Reference
54460000 hex	Move Link Constant Velocity Insufficient Travel Distance	Motion Control Instructions	W503
54470000 hex	Positioning Gear Operation Insufficient Target Velocity	Motion Control Instructions	W503
54480000 hex	Same Start Point and End Point for Circular Interpolation	Motion Control Instructions	W503
54490000 hex	Circular Interpolation Center Specification Position Out of Range	Motion Control Instructions	W503
544A0000 hex	Instruction Execution Error Caused by Count Mode Setting	Motion Control Instructions	W503
544C0000 hex	Parameter Selection Out of Range	Motion Control Instructions	W503
544D0000 hex	Stop Method Selection Out of Range	Motion Control Instructions	W503
544E0000 hex	Latch ID Selection Out of Range for Trigger Input Condition	Motion Control Instructions	W503
544F0000 hex	Setting Out of Range for Writing MC Setting	Motion Control Instructions	W503
54500000 hex	Trigger Input Condition Mode Selection Out of Range	Motion Control Instructions	W503
54510000 hex	Drive Trigger Signal Selection Out of Range for Trigger Input Condition	Motion Control Instructions	W503
54530000 hex	Motion Control Instruction Re-execution Disabled (Axis Specification)	Motion Control Instructions	W503
54540000 hex	Motion Control Instruction Re-execution Disabled (Buffer Mode Selection)	Motion Control Instructions	W503
54550000 hex	Motion Control Instruction Re-execution Disabled (Direction Selection)	Motion Control Instructions	W503
54560000 hex	Motion Control Instruction Re-execution Disabled (Execution Mode)	Motion Control Instructions	W503
54570000 hex	Motion Control Instruction Re-execution Disabled (Axes Group Specification)	Motion Control Instructions NJ Robotics Function	W503 W539
54580000 hex	Motion Control Instruction Re-execution Disabled (Jerk Setting)	Motion Control Instructions	W503
54590000 hex	Motion Control Instruction Re-execution Disabled (Master Axis)	Motion Control Instructions	W503
545A0000 hex	Motion Control Instruction Re-execution Disabled (MasterOffset)	Motion Control Instructions	W503
545B0000 hex	Motion Control Instruction Re-execution Disabled (MasterScaling)	Motion Control Instructions	W503



Event code	Event name	Functional classification	Reference
545C0000 hex	Motion Control Instruction Re-execution Disabled (Master-StartDistance)	Motion Control Instructions	W503
545D0000 hex	Motion Control Instruction Re-execution Disabled (Continuous)	Motion Control Instructions	W503
545E0000 hex	Motion Control Instruction Re-execution Disabled (MoveMode)	Motion Control Instructions	W503
545F0000 hex	Illegal Auxiliary Axis Specification	Motion Control Instructions	W503
54600000 hex	Illegal Axis Specification	Motion Control Instructions	W503
54610000 hex	Illegal Axes Group Specification	Motion Control Instructions NJ Robotics Function	W503 W539
54620000 hex	Illegal Master Axis Specification	Motion Control Instructions	W503
54630000 hex	Motion Control Instruction Re-execution Disabled (SlaveOffset)	Motion Control Instructions	W503
54640000 hex	Motion Control Instruction Re-execution Disabled (SlaveScaling)	Motion Control Instructions	W503
54650000 hex	Motion Control Instruction Re-execution Disabled (StartPosition)	Motion Control Instructions	W503
54660000 hex	Instruction Execution Error with Undefined Home	Motion Control Instructions NJ Robotics Function	W503 W539
54670000 hex	Motion Control Instruction Re-execution Disabled (Position Type)	Motion Control Instructions	W503
54680000 hex	Unused Axis Specification for Master Axis	Motion Control Instructions	W503
54690000 hex	First Position Setting Out of Range	Motion Control Instructions	W503
546A0000 hex	Last Position Setting Out of Range	Motion Control Instructions	W503
546B0000 hex	Illegal First/Last Position Size Relationship (Linear Mode)	Motion Control Instructions	W503
546C0000 hex	Master Sync Start Position Setting Out of Range	Motion Control Instructions	W503
546D0000 hex	Slave Sync Start Position Setting Out of Range	Motion Control Instructions	W503
546E0000 hex	Duplicate Latch ID for Trigger Input Condition	Motion Control Instructions	W503
546F0000 hex	Jerk Override Factor Out of Range	Motion Control Instructions	W503
54700000 hex	Acceleration/Deceleration Override Factor Out of Range	Motion Control Instructions	W503
54710000 hex	First Position Method Specification Out of Range	Motion Control Instructions	W503
54720000 hex	Motion Control Instruction Re-execution Disabled (First Position Method)	Motion Control Instructions	W503
54740000 hex	Unused Axis Specification for Auxiliary Axis	Motion Control Instructions	W503

Event code	Event name	Functional classification	Reference
54750000 hex	Position Gear Value Error	Motion Control Instructions	W503
54760000 hex	Position Gear Master Axis Zero Velocity	Motion Control Instructions	W503
54770000 hex	Cam Table Data Error during Cam Motion	General Motion Control	W503
54780000 hex	Target Position Setting Out of Range	Motion Control Instructions NJ Robotics Function	W503 W539
54790000 hex	Travel Distance Out of Range	Motion Control Instructions	W503
547A0000 hex	Cam Table Start Point Setting Out of Range	Motion Control Instructions	W503
547B0000 hex	Cam Master Axis Following First Position Setting Out of Range	Motion Control Instructions	W503
547C0000 hex	Circular Interpolation Radius Setting Error	Motion Control Instructions	W503
547D0000 hex	Circular Interpolation Radius Overflow	Motion Control Instructions	W503
547E0000 hex	Circular Interpolation Setting Out of Range	Motion Control Instructions	W503
547F0000 hex	Auxiliary/Slave Axis Numbers Not in Ascending Order	Motion Control Instructions	W503
54800000 hex	Cam Table Property Ascending Data Error at Update	Motion Control Instructions	W503
54810000 hex	MC_Write Target Out of Range	Motion Control Instructions	W503
54820000 hex	Master Travel Distance Specification Out of Range	Motion Control Instructions	W503
54830000 hex	Master Distance in Acceleration Specification Out of Range	Motion Control Instructions	W503
54840000 hex	Master Distance in Deceleration Specification Out of Range	Motion Control Instructions	W503
54850000 hex	Immediate Stop Instruction Executed	General Motion Control	W503
54860000 hex	Axes Group Immediate Stop Instruction Executed	General Motion Control	W503
54870000 hex	Execution Mode Selection Out of Range	Motion Control Instructions	W503
54880000 hex	Permitted Following Error Out of Range	Motion Control Instructions	W503
54890000 hex	Border Point/Center Position/Radius Specification Out of Range	Motion Control Instructions	W503
548A0000 hex	End Point Specification Out of Range	Motion Control Instructions	W503
548B0000 hex	Slave Travel Distance Specification Out of Range	Motion Control Instructions	W503
548C0000 hex	Phase Shift Amount Out of Range	Motion Control Instructions	W503
548D0000 hex	Feeding Distance Out of Range	Motion Control Instructions	W503
548E0000 hex	Auxiliary and Slave Defined as Same Axis	Motion Control Instructions	W503

Event code	Event name	Functional classification	Reference
548F0000 hex	Relative Position Selection Out of Range	Motion Control Instructions	W503
54900000 hex	Cam Transition Specification Out of Range	Motion Control Instructions	W503
54910000 hex	Synchronized Control End Mode Selection Out of Range	Motion Control Instructions	W503
54920000 hex	Enable External Latch Instruction Execution Disabled	Motion Control Instructions	W503
54930000 hex	Master Axis Offset Out of Range	Motion Control Instructions	W503
54940000 hex	Slave Axis Offset Out of Range	Motion Control Instructions	W503
54950000 hex	Command Current Position Count Selection Out of Range	Motion Control Instructions	W503
54960000 hex	Master Axis Gear Ratio Numerator Out of Range	Motion Control Instructions	W503
54970000 hex	Master Axis Gear Ratio Denominator Out of Range	Motion Control Instructions	W503
54980000 hex	Auxiliary Axis Gear Ratio Numerator Out of Range	Motion Control Instructions	W503
54990000 hex	Auxiliary Axis Gear Ratio Denominator Out of Range	Motion Control Instructions	W503
549A0000 hex	Master Axis Position Type Selection Out of Range	Motion Control Instructions	W503
549B0000 hex	Auxiliary Axis Position Type Selection Out of Range	Motion Control Instructions	W503
549C0000 hex	Target Position Ring Counter Out of Range	Motion Control Instructions	W503
549D0000 hex	Axes Group Composition Axis Setting Out of Range	Motion Control Instructions	W503
549E0000 hex	Axis Use Setting Out of Range	Motion Control Instructions	W503
54A00000 hex	Results Information, ID Tag Address Error	CJ-series ID Sensor Units	Z317
54A10000 hex	Results Information, Write Protection Error	CJ-series ID Sensor Units	Z317
54A20000 hex	Results Information, Command Error	CJ-series ID Sensor Units	Z317
54A80000 hex	Command Error	CJ-series Serial Communications Units	W494
54A90000 hex	Sequence Abort Completed	CJ-series Serial Communications Units	W494
54AA0000 hex	Protocol Macro Error	CJ-series Serial Communications Units	W494
54AE0000 hex	Multiple Switches ON Error	CJ-series EtherNet/IP Units	W495
54AF0000 hex	Access Detected Outside Range of Variable	CJ-series EtherNet/IP Units	W495
54E00000 hex	Access Detected Outside Range of Variable	EtherNet/IP	W503
55000000 hex	Division by Zero	NX-series Safety Control Unit	Z930
55010000 hex	Cast Error	NX-series Safety Control Unit	Z930
55020000 hex	MUX Error	NX-series Safety Control Unit	Z930

Event code	Event name	Functional classification	Reference
55100000 hex	Robot Control Instruction Re-execution Disabled	General Robot Control	O037
55110000 hex	V+ Task Number Setting Out of Range	General Robot Control	O037
55120000 hex	Illegal Robot Specification	General Robot Control	O037
55130000 hex	Illegal Parameter List Specification	General Robot Control	O037
55140000 hex	Starting Step Setting Out of Range	General Robot Control	O037
55150000 hex	Target Position Setting Out of Range	General Robot Control	O037
55160000 hex	Lefty and Righty Setting Out of Range	General Robot Control	O037
55170000 hex	Above and Below Setting Out of Range	General Robot Control	O037
55180000 hex	Flip Setting Out of Range	General Robot Control	O037
55190000 hex	Velocity Profile Selection Out of Range	General Robot Control	O037
551A0000 hex	Velocity Mode Selection Out of Range	General Robot Control	O037
551B0000 hex	Velocity Ratio Setting Out of Range	General Robot Control	O037
551C0000 hex	Rotation Velocity Ratio Setting Out of Range	General Robot Control	O037
551D0000 hex	Velocity Setting Out of Range	General Robot Control	O037
551E0000 hex	Acceleration Ratio Setting Out of Range	General Robot Control	O037
551F0000 hex	Deceleration Ratio Setting Out of Range	General Robot Control	O037
55200000 hex	Positioning Accuracy Selection Out of Range	General Robot Control	O037
55210000 hex	Rotation Limit Selection Out of Range	General Robot Control	O037
55220000 hex	Buffer Mode Selection Out of Range	General Robot Control	O037
55230000 hex	Target Position Specification Method Setting Out of Range	General Robot Control	O037
55330000 hex	Robot Control Instruction Executed while Robot is not Attached	General Robot Control	O037
55350000 hex	Tool Coordination Transform Setting Out of Range	General Robot Control	O037
55360000 hex	Robot Control Instruction Multi-execution Disabled	General Robot Control	O037
553C0000 hex	Robot Control Instruction Multi-execution Buffer Limit Exceeded	General Robot Control	O037
553D0000 hex	Robot Control Instruction Executed with Calibration Not Completed	General Robot Control	O037

Event code	Event name	Functional classification	Reference
553E0000 hex	Robot Control Instruction Executed while Robot High Power is OFF	General Robot Control	O037
553F0000 hex	Robot Already Attached	General Robot Control	O037
55400000 hex	Robot Control Instruction Executed while Robot is MANUAL Mode or is not COMP Mode	General Robot Control	O037
55440000 hex	Cannot Execute Robot Control Instruction	General Robot Control	O037
55480000 hex	Illegal Program Name Specification	General Robot Control	O037
56000000 hex	Illegal CNC Coordinate System Specification	CNC Function	O030
56010000 hex	Deceleration Setting Out of Range	CNC Function	O030
56020000 hex	Jerk Setting Out of Range	CNC Function	O030
56030000 hex	CNC Instruction Re-execution Disabled	CNC Function	O030
56040000 hex	CNC Multi-execution Disabled	CNC Function	O030
56050000 hex	Unassigned Logical CNC Motor Number Specified	CNC Function	O030
56060000 hex	Logical CNC Motor Number Out of Range	CNC Function	O030
56070000 hex	Target Position Setting Out of Range	CNC Function	O030
56080000 hex	Impossible CNC Motor Operation Specified when the Servo is OFF	CNC Function	O030
56090000 hex	Target Velocity Setting Out of Range	CNC Function	O030
560A0000 hex	Acceleration/Deceleration Setting Out of Range	CNC Function	O030
560B0000 hex	Travel Mode Selection Out of Range	CNC Function	O030
560C0000 hex	Immediate Stop Instruction Executed	CNC Function	O030
560D0000 hex	Parameter Selection Out of Range	CNC Function	O030
560E0000 hex	CNC Parameter Setting Read/Write Setting Value Out of Range	CNC Function	O030
560F0000 hex	CNC Parameter Setting Read/Write Target Out of Range	CNC Function	O030
56100000 hex	Cycle Start Error with Undefined Home	CNC Function	O030
56110000 hex	Homing Parameter Setting Out of Range	CNC Function	O030
56120000 hex	M Code Number Out of Range	CNC Function	O030
56130000 hex	CNC Instruction Re-execution Disabled (CNC Coordinate System Specification)	CNC Function	O030

Event code	Event name	Functional classification	Reference
56140000 hex	CNC Instruction Re-execution Disabled (Logical CNC Motor Number)	CNC Function	O030
56150000 hex	Illegal NC Program	CNC Function	O030
56160000 hex	Cycle Start Multi-execution Disabled	CNC Function	O030
56170000 hex	Impossible CNC Motor Cycle Start Specified when the Servo is OFF	CNC Function	O030
56180000 hex	Illegal NC Program Number Specification	CNC Function	O030
56190000 hex	Illegal Back Trace Specification	CNC Function	O030
561D0000 hex	SD Memory Card Access Failure	CNC Function	O030
561E0000 hex	File Does Not Exist	CNC Function	O030
561F0000 hex	Illegal Load NC Program Number Specification	CNC Function	O030
56200000 hex	Too Many Files Open	CNC Function	O030
56210000 hex	File or Directory Name Is Too Long	CNC Function	O030
56220000 hex	SD Memory Card Access Failed	CNC Function	O030
56230000 hex	Load NC Program Capacity Exceeded	CNC Function	O030
56240000 hex	Number of NC Program Exceeded	CNC Function	O030
56250000 hex	Illegal CNC Motor Specification	CNC Function	O030
56260000 hex	Illegal CNC Motor Compensation Table Specification	CNC Function	O030
56280000 hex	Illegal Load NC Program	CNC Function	O030
56290000 hex	NC Program Capacity Exceeded	CNC Function	O030
57000000 hex	Homing Parameter Setting Out of Range	Motion Control Instructions	W503
57020000 hex	Axis Use Change Error	Motion Control Instructions	W503
57030000 hex	Cannot Change Axis Use	Motion Control Instructions	W503
57050000 hex	Kinematics Unsupported Instruction	NJ Robotics Function	W539
57060000 hex	Axes Group Mismatch with Kinematics	NJ Robotics Function	W539
57070000 hex	Kinematics Type Out of Range	NJ Robotics Function	W539
57080000 hex	Kinematics Parameter Out of Range	NJ Robotics Function	W539
57090000 hex	Workspace Type Out of Range	NJ Robotics Function	W539
570A0000 hex	Workspace Parameter Out of Range	NJ Robotics Function	W539
570B0000 hex	Invalid Coordinate System Number	NJ Robotics Function	W539
570C0000 hex	Coordinate Transformation Parameter Out of Range	NJ Robotics Function	W539
570D0000 hex	Transition parameters out of range	NJ Robotics Function	W539

Event code	Event name	Functional classification	Reference
570F0000 hex	Cannot Calculate Kinematics	NJ Robotics Function	W539
57100000 hex	Kinematics Transform Not Set	NJ Robotics Function	W539
57110000 hex	Target Position Out of Range	NJ Robotics Function	W539
57120000 hex	Velocity Error Detection Value Out of Range	NJ Robotics Function	W539
57130000 hex	Acceleration Error Detection Value Out of Range	NJ Robotics Function	W539
57140000 hex	Trajectory Target Time Out of Range	NJ Robotics Function	W539
57150000 hex	Trajectory Type Out of Range	NJ Robotics Function	W539
57160000 hex	Trajectory Transition Out of Range	NJ Robotics Function	W539
57170000 hex	Trajectory Travel Distance Out of Range	NJ Robotics Function	W539
57190000 hex	Initial Workpiece Position Outside Workspace	NJ Robotics Function	W539
571A0000 hex	Invalid Conveyor Axis Specified	NJ Robotics Function	W539
571B0000 hex	Target Position Outside Workspace	NJ Robotics Function	W539
571C0000 hex	Cannot Cancel Synchronization	NJ Robotics Function	W539
571D0000 hex	Too Many Reset Motion Control Error Instructions	General Motion Control	W503
571E0000 hex	Too Many Kinematics	NJ Robotics Function	W539
571F0000 hex	Kinematics Initialization Error	NJ Robotics Function	W539
57200000 hex	Motion Control Parameter Setting Error When Changing Axis Use	Motion Control Instructions	W503
57210000 hex	Required Process Data Object Not Set When Changing Axis Use	Motion Control Instructions	W503
57220000 hex	Actual Position Overflow/Underflow	Motion Control Instructions	W503
57230000 hex	Switch Structure Track Number Setting Out of Range	Motion Control Instructions	W503
57240000 hex	Switch Structure First ON Position Setting Out of Range	Motion Control Instructions	W503
57250000 hex	Switch Structure Last ON Position Setting Out of Range	Motion Control Instructions	W503
57260000 hex	Switch Structure Axis Direction Out of Range	Motion Control Instructions	W503
57270000 hex	Switch Structure Cam Switch Mode Out of Range	Motion Control Instructions	W503
57280000 hex	Switch Structure Duration Setting Out of Range	Motion Control Instructions	W503
57290000 hex	Track Option Structure ON Compensation Setting Out of Range	Motion Control Instructions	W503
572A0000 hex	Track Option Structure OFF Compensation Setting Out of Range	Motion Control Instructions	W503

Event code	Event name	Functional classification	Reference
572B0000 hex	Number of Array Elements in Switch Structure Variable Out of Range	Motion Control Instructions	W503
572C0000 hex	Number of Array Elements in Output Signal Structure Variable Out of Range	Motion Control Instructions	W503
572D0000 hex	Number of Array Elements in Track Option Structure Variable Out of Range	Motion Control Instructions	W503
572E0000 hex	Numbers of Elements in Output Signals and Track Option Arrays Not Matched	Motion Control Instructions	W503
572F0000 hex	Motion Control Instruction Multi-execution Disabled (Master Axis)	Motion Control Instructions	W503
57300000 hex	Motion Control Instruction Multi-execution Disabled (Position Type Selection)	Motion Control Instructions	W503
57310000 hex	Same Track Number Setting in Switch Structure Out of Range	Motion Control Instructions	W503
57320000 hex	Invalid Tool Number	NJ Robotics Function	W539
57330000 hex	Tool Parameter Out of Range	NJ Robotics Function	W539
57340000 hex	Unsupported Transition Data	NJ Robotics Function	W539
57360000 hex	Offset Not Allowed	NJ Robotics Function	W539
57370000 hex	Motion Control Instruction Multi-execution Disabled (Trajectory Type)	NJ Robotics Function	W539
57390000 hex	Unsupported Transition Mode	NJ Robotics Function	W539
573A0000 hex	Cannot Write Axis Parameters	Motion Control Instructions	W503
573B0000 hex	Axis Parameter Setting Out of Range	Motion Control Instructions	W503
573C0000 hex	Cam Property Setting Out of Range	Motion Control Instructions	W503
573D0000 hex	Cam Node Setting Out of Range	Motion Control Instructions	W503
573E0000 hex	Incorrect Cam Node Type Specification	Motion Control Instructions	W503
573F0000 hex	Insufficient Nodes in Cam Table	Motion Control Instructions	W503
57400000 hex	Cam Node Master Axis Phase Not in Ascending Order	Motion Control Instructions	W503
57410000 hex	Too Many Data Points in Cam Table	Motion Control Instructions	W503
57420000 hex	Cam Table Displacement Overflow	Motion Control Instructions	W503
57430000 hex	Aborted Cam Table Used	Motion Control Instructions	W503
57440000 hex	Jog Mode Out of Range	NJ Robotics Function	W539
57450000 hex	Initial Workpiece Position Out of Range	NJ Robotics Function	W539
57460000 hex	Maximum Interpolation Velocity Out of Range	NJ Robotics Function	W539

Event code	Event name	Functional classification	Reference
57470000 hex	Maximum Interpolation Acceleration Out of Range	NJ Robotics Function	W539
57480000 hex	Maximum Interpolation Deceleration Out of Range	NJ Robotics Function	W539
57490000 hex	Execution ID Setting Out of Range	Motion Control Instructions	W503
574A0000 hex	Position Offset Out of Range	Motion Control Instructions	W503
574B0000 hex	PDS State Transition Command Selection Out of Range	Motion Control Instructions	W503
574C0000 hex	Single-axis Position Control Axis Motion Control Instruction Execution Disabled	Motion Control Instructions	W503
57510000 hex	Cam Monitor Mode Selection Out of Range	Motion Control Instructions	W503
57520000 hex	Data Type of Cam Monitor Values Mismatch	Motion Control Instructions	W503
57530000 hex	Sync Mode Setting Out of Range	Motion Control Instructions	W503
57540000 hex	Gear Master Axis Following First Position Setting Out of Range	Motion Control Instructions	W503
57550000 hex	Torque Limit Mode Setting Out of Range	Motion Control Instructions	W503
57560000 hex	Insufficient Cam Nodes	Motion Control Instructions	W503
57570000 hex	Cam Node Start Point Position Out of Range	Motion Control Instructions	W503
57580000 hex	Cam Operation Displacement Overflow	Motion Control Instructions	W503
57590000 hex	Reversing Operation Not Possible	Motion Control Instructions	W503
58210000 hex	Output Control Timeout for Parallel I/O, PLC Link, or EtherNet/IP	FH/FZ5 Series Vision System	Z342
58220000 hex	Output Control Timeout for EtherCAT	FH/FZ5 Series Vision System	Z342
58230000 hex	Initial scene group error	FH/FZ5 Series Vision System	Z342
58240000 hex	Initial scene number error	FH/FZ5 Series Vision System	Z342
60010000 hex	Task Period Exceeded	Errors Related to Tasks	W503
60020000 hex	Task Execution Timeout	Errors Related to Tasks	W503
60030000 hex	I/O Refreshing Timeout Error	Errors Related to Tasks	W503
60040000 hex	Insufficient System Service Time Error	Errors Related to Tasks	W503
60050000 hex	Task Period Exceeded	Errors Related to Tasks	W503
64010000 hex	Impossible to Access Special Unit	Errors Related to CJ-series Unit Configuration	W503
64040000 hex	Upper Limit of Sampling Processing Capacity	Errors Related to Controller Operation	W503
64050000 hex	Capacity Warning of Variable Log Save Destination	Errors Related to Controller Operation	W503
64060000 hex	No Variable Log Concurrency	Errors Related to Controller Operation	W503

Event code	Event name	Functional classification	Reference
64070000 hex	Cycle with No Variable Sampling	Errors Related to Controller Operation	W503
64080000 hex	Secure Communication Forced Start	Errors Related to Controller Operation	W503
64200000 hex	Emergency Message Detected	EtherCAT Master	W503
64400000 hex	Target Position Positive Software Limit Exceeded	Motion Control Instructions	W503
64410000 hex	Target Position Negative Software Limit Exceeded	Motion Control Instructions	W503
64420000 hex	Command Position Overflow/Underflow	Motion Control Instructions	W503
64430000 hex	Positive Limit Input	Motion Control Instructions NJ Robotics Function	W503 W539
64440000 hex	Negative Limit Input	Motion Control Instructions NJ Robotics Function	W503 W539
64450000 hex	Positive Software Limit Exceeded	General Motion Control	W503
64460000 hex	Negative Software Limit Exceeded	General Motion Control	W503
64470000 hex	In-position Check Time Exceeded	General Motion Control	W503
64480000 hex	Following Error Limit Exceeded	General Motion Control	W503
64490000 hex	Immediate Stop Input	General Motion Control	W503
644A0000 hex	Positive Limit Input Detected	General Motion Control	W503
644B0000 hex	Negative Limit Input Detected	General Motion Control	W503
644C0000 hex	Following Error Warning	General Motion Control	W503
644D0000 hex	Velocity Warning	General Motion Control	W503
644E0000 hex	Acceleration Warning	General Motion Control	W503
644F0000 hex	Deceleration Warning	General Motion Control	W503
64500000 hex	Positive Torque Warning	General Motion Control	W503
64510000 hex	Negative Torque Warning	General Motion Control	W503
64520000 hex	Command Position Overflow	General Motion Control	W503
64530000 hex	Command Position Underflow	General Motion Control	W503
64540000 hex	Actual Position Overflow	General Motion Control	W503
64550000 hex	Actual Position Underflow	General Motion Control	W503
64560000 hex	Illegal Following Error	General Motion Control	W503
64570000 hex	Servo OFF Error	General Motion Control	W503
64580000 hex	Absolute Encoder Current Position Calculation Failed	General Motion Control	W503
64590000 hex	Home Undefined during Coordinated Motion	General Motion Control NJ Robotics Function	W503 W539
645A0000 hex	Maximum Interpolation Velocity Error	NJ Robotics Function	W539
645B0000 hex	Maximum Interpolation Acceleration Error	NJ Robotics Function	W539
645C0000 hex	Maximum Interpolation Deceleration Error	NJ Robotics Function	W539
64780000 hex	Input Disconnection Detected	CJ-series Analog I/O Units	W490
64790000 hex	Output Set Value Error	CJ-series Analog I/O Units	W490

Event code	Event name	Functional classification	Reference
647A0000 hex	Input Error	CJ-series Process I/O Units	W498
647D0000 hex	Zero/Span Adjustment Period End	CJ-series Process I/O Units	W498
647E0000 hex	Zero/Span Adjustment Period Notice	CJ-series Process I/O Units	W498
64840000 hex	Sensor Error	CJ-series Temperature Control Units	W491
64850000 hex	CT Overflow	CJ-series Temperature Control Units	W491
64860000 hex	Heater Burnout Alarm	CJ-series Temperature Control Units	W491
648C0000 hex	Unit Status, Command Error End	CJ-series ID Sensor Units	Z317
648D0000 hex	Results Information, Verification Error	CJ-series ID Sensor Units	Z317
648E0000 hex	Results Information, ID Tag Communications Error	CJ-series ID Sensor Units	Z317
648F0000 hex	Results Information, ID Tag Missing Error	CJ-series ID Sensor Units	Z317
64900000 hex	Results Information, ID System Error 1	CJ-series ID Sensor Units	Z317
64910000 hex	Results Information, ID System Error 2	CJ-series ID Sensor Units	Z317
64920000 hex	Results Information, ID System Error 3	CJ-series ID Sensor Units	Z317
64930000 hex	Results Information, ID Tag Status	CJ-series ID Sensor Units	Z317
64940000 hex	Results Information, Error Correction	CJ-series ID Sensor Units	Z317
64980000 hex	Representative Warning	CJ-series CompoNet Master Unit	W493
64990000 hex	Representative Alarm	CJ-series CompoNet Master Unit	W493
64A00000 hex	Tfs (Send Finished Monitoring Time) Exceeded	CJ-series Serial Communications Units	W494
64A10000 hex	Tfr (Receive Finished Monitoring Time) Exceeded	CJ-series Serial Communications Units	W494
64A20000 hex	Tr (Receive Wait Monitoring Time) Exceeded	CJ-series Serial Communications Units	W494
64A30000 hex	FCS Check Error	CJ-series Serial Communications Units	W494
64A40000 hex	Timeout Error	CJ-series Serial Communications Units	W494
64A50000 hex	Comparison Error	CJ-series Serial Communications Units	W494
64A60000 hex	Reception Overflow	CJ-series Serial Communications Units	W494
64A70000 hex	Command Format Error	CJ-series Serial Communications Units	W494
64AC0000 hex	Send Timeout Error	CJ-series DeviceNet Units	W497

Event code	Event name	Functional classification	Reference
64CC0000 hex	I/O Disconnection Detected	GX-series EtherCAT Slave Units	W488
64E00000 hex	Drive Prohibition Input Error 1	Servo G5 and G5 Linear	I576 I577
64E10000 hex	Drive Prohibition Input Error 2	Servo G5 and G5 Linear	I576 I577
64E20000 hex	Immediate Stop Input Error	Servo G5 and G5 Linear	I576 I577
64E30000 hex	Drive Prohibition Input Error	Servo 1S	I586 I621
64F00000 hex	Unit Over Range for Channel 1	NX-series Analog I/O Units	W522
64F10000 hex	Unit Over Range for Channel 2	NX-series Analog I/O Units	W522
64F20000 hex	Unit Over Range for Channel 3	NX-series Analog I/O Units	W522
64F30000 hex	Unit Over Range for Channel 4	NX-series Analog I/O Units	W522
64F40000 hex	Unit Over Range for Channel 5	NX-series Analog I/O Units	W522
64F50000 hex	Unit Over Range for Channel 6	NX-series Analog I/O Units	W522
64F60000 hex	Unit Over Range for Channel 7	NX-series Analog I/O Units	W522
64F70000 hex	Unit Over Range for Channel 8	NX-series Analog I/O Units	W522
64F80000 hex	Unit Under Range for Channel 1	NX-series Analog I/O Units	W522
64F90000 hex	Unit Under Range for Channel 2	NX-series Analog I/O Units	W522
64FA0000 hex	Unit Under Range for Channel 3	NX-series Analog I/O Units	W522
64FB0000 hex	Unit Under Range for Channel 4	NX-series Analog I/O Units	W522
64FC0000 hex	Unit Under Range for Channel 5	NX-series Analog I/O Units	W522
64FD0000 hex	Unit Under Range for Channel 6	NX-series Analog I/O Units	W522
64FE0000 hex	Unit Under Range for Channel 7	NX-series Analog I/O Units	W522
64FF0000 hex	Unit Under Range for Channel 8	NX-series Analog I/O Units	W522
65030000 hex	Unit I/O Disconnection Detected for Channel 1	NX-series Analog I/O Units	W522
65040000 hex	Unit I/O Disconnection Detected for Channel 2	NX-series Analog I/O Units	W522
65050000 hex	Unit I/O Disconnection Detected for Channel 3	NX-series Analog I/O Units	W522
65060000 hex	Unit I/O Disconnection Detected for Channel 4	NX-series Analog I/O Units	W522
65070000 hex	Unit I/O Disconnection Detected for Channel 5	NX-series Analog I/O Units	W522
65080000 hex	Unit I/O Disconnection Detected for Channel 6	NX-series Analog I/O Units	W522
65090000 hex	Unit I/O Disconnection Detected for Channel 7	NX-series Analog I/O Units	W522
650A0000 hex	Unit I/O Disconnection Detected for Channel 8	NX-series Analog I/O Units	W522
65100000 hex	Sensor Disconnected Error	NX-series Analog I/O Units and NX-series Temperature Control Units	W566 H228
65110000 hex	Process Value Over Range	NX-series Analog I/O Units	W566
65120000 hex	Process Value Under Range	NX-series Analog I/O Units	W566
65130000 hex	Sensor Disconnected Error	NX-series Load Cell Input Units	W565
65140000 hex	Over Range	NX-series Load Cell Input Units	W565
65150000 hex	Under Range	NX-series Load Cell Input Units	W565

Event code	Event name	Functional classification	Reference
65200000 hex	I/O Power Supply Voltage Error	NX-series Safety Control Unit	Z930
65210000 hex	Output Power Interrupt Circuit Error	NX-series Safety Control Unit	Z930
65220000 hex	External Test Signal Failure at Safety Input	NX-series Safety Control Unit	Z930
65230000 hex	Discrepancy Error at Safety Input	NX-series Safety Control Unit	Z930
65240000 hex	Overload Detected at Test Output	NX-series Safety Control Unit	Z930
65250000 hex	Stuck-at-high Detected at Test Output	NX-series Safety Control Unit	Z930
65270000 hex	Short Circuit Detected at Safety Output	NX-series Safety Control Unit	Z930
65280000 hex	Stuck-at-high Detected at Safety Output	NX-series Safety Control Unit	Z930
652C0000 hex	Heater Burnout Detected	NX-series Analog I/O Units and NX-series Temperature Control Units	W566 H228
652D0000 hex	SSR Failure Detected	NX-series Analog I/O Units and NX-series Temperature Control Units	W566 H228
652E0000 hex	Alarm Detected	NX-series Temperature Control Units	H228
65900000 hex	I/O Refreshing Timeout Error	X Bus Unit	W503
66000000 hex	Send Transaction Queue Overrun	GEM Services	W528
66010000 hex	Reception Transaction Queue Overrun	GEM Services	W528
66020000 hex	Too Long SECS Message	GEM Services	W528
67000000 hex	Command Position Outside Workspace	NJ Robotics Function	W539
67010000 hex	Current Position Outside Workspace	NJ Robotics Function	W539
67020000 hex	Workpiece Synchronization Excessive Following Error	NJ Robotics Function	W539
67030000 hex	Velocity Error Detection	NJ Robotics Function	W539
67040000 hex	Acceleration Error Detection	NJ Robotics Function	W539
67050000 hex	Command Current Velocity Limit Exceeded	NJ Robotics Function	W539
67800000 hex	Immediate Stop Input	CNC Function	O030
67810000 hex	Positive Limit Input Detected	CNC Function	O030
67820000 hex	Negative Limit Input Detected	CNC Function	O030
67830000 hex	Target Position Positive Software Limit Exceeded	CNC Function	O030
67840000 hex	Target Position Negative Software Limit Exceeded	CNC Function	O030
67850000 hex	Command Position Overflow/Underflow	CNC Function	O030
67860000 hex	Positive Limit Input	CNC Function	O030
67870000 hex	Negative Limit Input	CNC Function	O030

Event code	Event name	Functional classification	Reference
67880000 hex	Positive Software Limit Exceeded	CNC Function	O030
67890000 hex	Negative Software Limit Exceeded	CNC Function	O030
678A0000 hex	In-position Check Time Exceeded	CNC Function	O030
678B0000 hex	Following Error Limit Exceeded	CNC Function	O030
678C0000 hex	Following Error Warning	CNC Function	O030
678D0000 hex	Command Position Overflow	CNC Function	O030
678E0000 hex	Command Position Underflow	CNC Function	O030
678F0000 hex	Actual Position Overflow	CNC Function	O030
67900000 hex	Actual Position Underflow	CNC Function	O030
67910000 hex	Illegal Following Error	CNC Function	O030
67920000 hex	Absolute Encoder Current Position Calculation Failed	CNC Function	O030
67930000 hex	Home Undefined during Coordinated Motion	CNC Function	O030
67940000 hex	Cycle Start Specified during Positive Software Limit Exceeded	CNC Function	O030
67950000 hex	Cycle Start Specified during Negative Software Limit Exceeded	CNC Function	O030
67960000 hex	Cycle Start Specified during Command Position Overflow (Underflow)	CNC Function	O030
67970000 hex	Cycle Start Specified during Positive Limit Input	CNC Function	O030
67980000 hex	Cycle Start Specified during Negative Limit Input	CNC Function	O030
67990000 hex	NC Program Execution Error	CNC Function	O030
68010000 hex	Unit Error	CJ-series High-speed Counter Units	W492
68200000 hex	Drive Prohibition Detected	Servo 1S	1586 1621
68210000 hex	Control Right Release Error	Servo 1S	1586 1621
68220000 hex	Error stop input	Servo 1S	1586 1621
68230000 hex	Software Limit Exceeded	Servo 1S	1586 1621
68370000 hex	SOPT Input Monitoring Error	Servo 1S	1621
68380000 hex	Safety Function Error	Servo 1S	1621
68390000 hex	Discrepancy Error at SF Input	Servo 1S	1621
683A0000 hex	SBC Relay Diagnosis Error	Servo 1S	1621
683B0000 hex	External Test Signal Failure at SOPT Input	Servo 1S	1621
683C0000 hex	Overload Detected at Test Output	Servo 1S	1621

Event code	Event name	Functional classification	Reference
683D0000 hex	Stuck-at-high Detected at Test Output	Servo 1S	I621
683E0000 hex	Overload Detected at SBC Output	Servo 1S	I621
683F0000 hex	Stuck-at-high Detected at SBC Output	Servo 1S	I621
68400000 hex	IOV Power Supply Voltage Error	Servo 1S	I621
68410000 hex	SBC Power Supply Voltage Error	Servo 1S	I621
68420000 hex	Monitoring Limit Exceedance Error	Servo 1S	I621
70010000 hex	Previous Time Specified	NX-series Digital I/O Units	W521
74200000 hex	Motion Control Period Exceeded	General Motion Control	W503
74210000 hex	Servo Main Circuit Power OFF	General Motion Control	W503
74220000 hex	Servo Main Circuits OFF	Motion Control Instructions	W503
74230000 hex	Interrupt Feeding Interrupt Signal Missing	General Motion Control	W503
74240000 hex	Homing Opposite Direction Limit Input Detected	General Motion Control	W503
74250000 hex	Homing Direction Limit Input Detected	General Motion Control	W503
74260000 hex	Homing Limit Inputs Detected in Both Directions	General Motion Control	W503
74270000 hex	Home Proximity/Homing Opposite Direction Limit Input Detected	General Motion Control	W503
74280000 hex	Home Proximity/Homing Direction Limit Input Detected	General Motion Control	W503
74290000 hex	Home Input/Homing Opposite Direction Limit Input Detected	General Motion Control	W503
742A0000 hex	Home Input/Homing Direction Limit Input Detected	General Motion Control	W503
742B0000 hex	Invalid Home Input Mask Distance	General Motion Control	W503
742C0000 hex	No Home Input	General Motion Control	W503
742D0000 hex	No Home Proximity Input	General Motion Control	W503
742F0000 hex	Slave Error Detected	General Motion Control	W503
74300000 hex	Axes Group Composition Axis Error	General Motion Control NJ Robotics Function	W503 W539
74320000 hex	Slave Observation Detected	General Motion Control	W503
74330000 hex	MC Common Error Occurrence	General Motion Control	W503
74340000 hex	Latch Position Overflow	General Motion Control	W503
74350000 hex	Latch Position Underflow	General Motion Control	W503
74360000 hex	Master Sync Direction Error	General Motion Control	W503
74370000 hex	Slave Disconnection during Servo ON	General Motion Control	W503
74380000 hex	Feed Distance Overflow	General Motion Control	W503
74390000 hex	Error in Changing Servo Drive Control Mode	General Motion Control	W503

Event code	Event name	Functional classification	Reference
743A0000 hex	Master Axis Position Read Error	General Motion Control	W503
743B0000 hex	Auxiliary Axis Position Read Error	General Motion Control	W503
743C0000 hex	Cannot Execute Save Cam Table Instruction	General Motion Control	W503
743D0000 hex	Incorrect Synchronization Command	NX-series Position Interface Units	W524
743E0000 hex	Illegal Following Error	NX-series Position Interface Units	W524
743F0000 hex	Illegal State Transition	NX-series Position Interface Units	W524
74600000 hex	Master Function Enable/Disable Failed	CJ-series DeviceNet Units	W497
74610000 hex	Master Fixed Allocation Area Setting Failed	CJ-series DeviceNet Units	W497
74620000 hex	Scan List Register/Clear Failed	CJ-series DeviceNet Units	W497
74630000 hex	Slave Function Enable/Disable Failed	CJ-series DeviceNet Units	W497
74640000 hex	Slave Fixed Allocation Area Setting Failed	CJ-series DeviceNet Units	W497
74800000 hex	Command Warning	Servo G5 and G5 Linear	I576 I577
74810000 hex	Command Error	Servo G5 and G5 Linear	I576 I577
74900000 hex	Multiple control signal input error	ZW-CE1□T Confocal Fiber Type Displacement Sensor	Z332
74910000 hex	EXE input error	ZW-CE1□T Confocal Fiber Type Displacement Sensor	Z332
74920000 hex	SYNC input error	ZW-CE1□T Confocal Fiber Type Displacement Sensor	Z332
74930000 hex	TIMING input error	ZW-CE1□T Confocal Fiber Type Displacement Sensor	Z332
74940000 hex	RESET input error	ZW-CE1□T Confocal Fiber Type Displacement Sensor	Z332
74950000 hex	ZERO input error	ZW-CE1□T Confocal Fiber Type Displacement Sensor	Z332
74960000 hex	ZEROCLR input error	ZW-CE1□T Confocal Fiber Type Displacement Sensor	Z332
74A00000 hex	SF_Antivalent Error	NX-series Safety Control Unit	Z930
74A10000 hex	SF_EDM Error	NX-series Safety Control Unit	Z930
74A20000 hex	SF_EmergencyStop Error	NX-series Safety Control Unit	Z930
74A30000 hex	SF_EnableSwitch Error	NX-series Safety Control Unit	Z930
74A40000 hex	SF_Equivalent Error	NX-series Safety Control Unit	Z930
74A50000 hex	SF_ESPE Error	NX-series Safety Control Unit	Z930
74A60000 hex	SF_GuardLocking Error	NX-series Safety Control Unit	Z930
74A70000 hex	SF_GuardMonitoring Error	NX-series Safety Control Unit	Z930
74A80000 hex	SF_ModeSelector Error	NX-series Safety Control Unit	Z930
74A90000 hex	SF_MutingPar Error	NX-series Safety Control Unit	Z930
74AA0000 hex	SF_MutingPar_2Sensor Error	NX-series Safety Control Unit	Z930

Event code	Event name	Functional classification	Reference
74AB0000 hex	SF_MutingSeq Error	NX-series Safety Control Unit	Z930
74AC0000 hex	SF_OutControl Error	NX-series Safety Control Unit	Z930
74AD0000 hex	SF_SafetyRequest Error	NX-series Safety Control Unit	Z930
74AE0000 hex	SF_TestableSafetySensor Error	NX-series Safety Control Unit	Z930
74AF0000 hex	SF_TwoHandControlTypeII Error	NX-series Safety Control Unit	Z930
74B00000 hex	SF_TwoHandControlTypeIII Error	NX-series Safety Control Unit	Z930
75000000 hex	Robot Control Period Exceeded	General Robot Control	O037
75010000 hex	Robot Control Common Error Occurred	General Robot Control	O037
75020000 hex	EtherCAT Slave Disconnection Error	General Robot Control	O037
75030000 hex	Robot Error Occurred	General Robot Control	O037
77000000 hex	Conveyor Axis Position Read Error	NJ Robotics Function	W539
77800000 hex	CNC Control Period Exceeded	CNC Function	O030
77810000 hex	CNC Planner Service Period Exceeded	CNC Function	O030
77820000 hex	CNC Coordinate System Composition CNC Motor Error	CNC Function	O030
77830000 hex	CNC Common Error Occurrence	CNC Function	O030
77840000 hex	Servo Main Circuits OFF	CNC Function	O030
77850000 hex	Servo Main Circuit Power OFF	CNC Function	O030
77860000 hex	Slave Error Detected	CNC Function	O030
77870000 hex	Slave Observation Detected	CNC Function	O030
77880000 hex	Slave Disconnection during Servo ON	CNC Function	O030
77890000 hex	Homing Opposite Direction Limit Input Detected	CNC Function	O030
778A0000 hex	Homing Direction Limit Input Detected	CNC Function	O030
778B0000 hex	Homing Limit Inputs Detected in Both Directions	CNC Function	O030
778C0000 hex	Home Proximity/Homing Opposite Direction Limit Input Detected	CNC Function	O030
778D0000 hex	Home Proximity/Homing Direction Limit Input Detected	CNC Function	O030
778E0000 hex	Home Input/Homing Opposite Direction Limit Input Detected	CNC Function	O030
778F0000 hex	Home Input/Homing Direction Limit Input Detected	CNC Function	O030
77900000 hex	Invalid Home Input Mask Distance	CNC Function	O030
77910000 hex	No Home Input	CNC Function	O030
77920000 hex	No Home Proximity Input	CNC Function	O030
78010000 hex	Operation Command Competition	Servo G5 and G5 Linear	I576 I577
78020000 hex	Absolute Encoder Status Error	Servo G5	I576

Event code	Event name	Functional classification	Reference
78080000 hex	TRIG Input Error	EtherCAT FQ-M-series Specialized Vision Sensors for Positioning	Z314
780A0000 hex	Scene Data Error	EtherCAT FQ-M-series Specialized Vision Sensors for Positioning	Z314
780B0000 hex	Model Error	EtherCAT FQ-M-series Specialized Vision Sensors for Positioning	Z314
780C0000 hex	Logging Error	EtherCAT FQ-M-series Specialized Vision Sensors for Positioning	Z314
780D0000 hex	Output Timeout	EtherCAT FQ-M-series Specialized Vision Sensors for Positioning	Z314
780E0000 hex	Output Size Error	EtherCAT FQ-M-series Specialized Vision Sensors for Positioning	Z314
78190000 hex	Image Logging Disk Write Error	FH/FZ5 Series Vision System	Z342
781A0000 hex	Setting Data Transfer Error	FH/FZ5 Series Vision System	Z342
781B0000 hex	Output Buffer Error (EtherCAT)	FH/FZ5 Series Vision System	Z342
78200000 hex	Pulse Output Overspeed Error	Servo 1S	I586 I621
78210000 hex	Brake Interlock Error	Servo 1S	I586 I621
78220000 hex	Command Warning	Servo 1S	I586
78230000 hex	Command Error	Servo 1S	I586 I621
80010000 hex	Illegal Packet Discarded	Errors Related to CJ-series Unit Configuration	W503
80100000 hex	Packet Discarded	Errors Related to FINS Communications	W503
80110000 hex	Packet Discarded	Errors Related to FINS Communications	W503
80120000 hex	Packet Discarded	Errors Related to FINS Communications	W503
80200000 hex	NX Unit I/O Communications Error	NX-series Digital I/O Units, NX-series Analog I/O Units, NX-series Position Interface Units, NX-series Communications Interface Units, NX-series Safety Control Units, NX-series Load Cell Input Units, NX-series IO-Link Master Units, NX-series Temperature Control Units, and NX-series High-speed Counter Units	W521 W522 W566 W524 W540 Z930 W565 W570 H228 W647

Event code	Event name	Functional classification	Reference
80210000 hex	NX Unit Output Synchronization Error	NX-series Digital I/O Units, NX-series Analog I/O Units, NX-series Position Interface Units, NX-series Load Cell Input Units, and NX-series High-speed Counter Units	W521 W522 W524 W565 W647
80220000 hex	NX Message Communications Error	NX-series EtherCAT Coupler Units, NX-series Analog I/O Units, NX-series Position Interface Units, NX-series Communications Interface Units, NX-series Safety Control Unit, NX-series Load Cell Input Units, NX-series IO-Link Master Units, NX-series Temperature Control Units, and NX-series High-speed Counter Units	W522 W566 W524 W540 Z930 W565 W570 H228 W647
80230000 hex	NX Message Communications Error	Errors Related to Controller Operation	W503
80240000 hex	NX Unit Clock Not Synchronized Error	NX-series Digital I/O Units, NX-series Analog I/O Units, NX-series Position Interface Units, NX-series Communications Interface Units, NX-series Load Cell Input Units, NX-series IO-Link Master Units, NX-series Temperature Control Units, and NX-series High-speed Counter Units	W521 W522 W566 W524 W540 W565 W570 H228 W647
80300000 hex	Safety Process Data Communications Timeout	NX-series Safety Control Unit	Z930
80310000 hex	CIP Safety Originator Connection Not Established Error	NX-series Safety Control Unit	Z930
80320000 hex	CIP Safety Originator Connection Timeout	NX-series Safety Control Unit	Z930
80330000 hex	CIP Safety Target Does Not Exist	NX-series Safety Control Unit	Z930
80340000 hex	CIP Safety Target Connection Timeout	NX-series Safety Control Unit	Z930
84010000 hex	IP Address Duplication Error	EtherNet/IP	W503
84020000 hex	BOOTP Server Connection Error	EtherNet/IP	W503
84030000 hex	DNS Server Connection Error	EtherNet/IP	W503
84040000 hex	NTP Server Connection Error	EtherNet/IP	W503
84050000 hex	Packet Discarded Due to Full Reception Buffer	EtherNet/IP	W503
84060000 hex	Link OFF Detected	EtherNet/IP	W503
84070000 hex	Tag Data Link Connection Failed	EtherNet/IP	W503
84080000 hex	Tag Data Link Timeout	EtherNet/IP	W503
84090000 hex	Tag Data Link Connection Timeout	EtherNet/IP	W503
840A0000 hex	IP Address Duplication Error	EtherNet/IP	W503

Event code	Event name	Functional classification	Reference
840B0000 hex	BOOTP Server Connection Error	EtherNet/IP	W503
840C0000 hex	Allowed Communications Bandwidth per Unit Exceeded	EtherNet/IP	W503
840E0000 hex	Number of Tag Sets for Tag Data Links Exceeded	EtherNet/IP	W503
840F0000 hex	DHCP Server Connection Error	EtherNet/IP	W503
84200000 hex	Link OFF Error	EtherCAT Master	W503
84210000 hex	Network Configuration Error	EtherCAT Master	W503
84220000 hex	Network Configuration Verification Error	EtherCAT Master	W503
84230000 hex	Slave Initialization Error	EtherCAT Master	W503
84280000 hex	Slave Application Error	EtherCAT Master	W503
84290000 hex	Process Data Transmission Error	EtherCAT Master	W503
842B0000 hex	Process Data Reception Timeout	EtherCAT Master	W503
842C0000 hex	Process Data Communications Error	EtherCAT Master	W503
842D0000 hex	EtherCAT Message Error	EtherCAT Master	W503
842E0000 hex	EtherCAT Frame Not Received	EtherCAT Master	W503
842F0000 hex	Input Process Data Invalid Error	EtherCAT Master	W503
84300001 hex	Slave State Transition Failed	EtherCAT Master	W503
84310002 hex	Illegal Slave Disconnection Detected	EtherCAT Master	W503
84320003 hex	Network Configuration Verification Error (Incorrect Wiring)	EtherCAT Master	W503
84330004 hex	Network Configuration Verification Error (Mismatched Slave)	EtherCAT Master	W503
84340000 hex	Slave PDI WDT Error Detected	EtherCAT Master	W503
84350000 hex	Illegal Mailbox Received	EtherCAT Master	W503
84360000 hex	Slave AL Status Error Detected	EtherCAT Master	W503
84370000 hex	Clock Synchronization Compensation Failed	EtherCAT Master	W503
84380000 hex	Network Configuration Verification Error (Slave Unconnected)	EtherCAT Master	W503
84390000 hex	Ring Disconnection Detected	EtherCAT Master	W503
843A0000 hex	Network Configuration Verification Error (Incorrect Ring Wiring)	EtherCAT Master	W503
843C0000 hex	Incorrect Wiring Detected	EtherCAT Master	W503
84400000 hex	EtherCAT Slave Communications Error	General Motion Control	W503
84600000 hex	Communications Error	CJ-series CompoNet Master Unit	W493
84610000 hex	Repeater Unit Communications Error	CJ-series CompoNet Master Unit	W493
84680000 hex	Transmission Error	CJ-series Serial Communications Units	W494

Event code	Event name	Functional classification	Reference
84690000 hex	Overflow Error	CJ-series Serial Communications Units	W494
846A0000 hex	Framing Error	CJ-series Serial Communications Units	W494
846B0000 hex	Parity Error	CJ-series Serial Communications Units	W494
846C0000 hex	Overflow Error, Framing Error, or Parity Error (Transmission Error)	CJ-series Serial Communications Units	W494
846D0000 hex	Transmission Error (CRC Error)	CJ-series Serial Communications Units	W494
84740000 hex	Bus Off Detected	CJ-series DeviceNet Units	W497
84750000 hex	Remote I/O Communications Error	CJ-series DeviceNet Units	W497
84760000 hex	Remote I/O Communications Error (during Slave Operation)	CJ-series DeviceNet Units	W497
84770000 hex	Slave COS Send Failed	CJ-series DeviceNet Units	W497
84790000 hex	Error-level Device Event	GX-series EtherCAT Slave Units	W570 W640
847A0000 hex	IO-Link Communications Error	GX-series EtherCAT Slave Units	W570 W640
847C0000 hex	Device Configuration Verification Error	GX-series EtherCAT Slave Units	W570 W640
84820000 hex	IO-Link Device Configuration Information Created	GX-series EtherCAT Slave Units	W570 W640
84840000 hex	I/O Cable Short-circuit	GX-series EtherCAT Slave Units	W570 W640
84850000 hex	I/O Power Supply ON Detected	GX-series EtherCAT Slave Units	W570
84860000 hex	Warning-level Device Event Flag	GX-series EtherCAT Slave Units	W570 W640
84870000 hex	IO-Link Communications Module Processing Error	GX-series EtherCAT Slave Units	W570
848C0000 hex	Error-level Device Event	NX-series IO-Link Master Units	W570
848D0000 hex	IO-Link Communications Error	NX-series IO-Link Master Units	W570
848F0000 hex	Device Configuration Verification Error	NX-series IO-Link Master Units	W570
84950000 hex	IO-Link Device Configuration Information Created	NX-series IO-Link Master Units	W570
84970000 hex	I/O Cable Short-circuit	NX-series IO-Link Master Units	W570
84980000 hex	I/O Power Supply ON Detected	NX-series IO-Link Master Units	W570
84990000 hex	Warning-level Device Event Flag	NX-series IO-Link Master Units	W570
849A0000 hex	IO-Link Communications Module Processing Error	NX-series IO-Link Master Units	W570
84A00000 hex	Slave Unit Verification Error	GX-series EtherCAT Slave Units	W488 W570 W640
84B00000 hex	EtherCAT Communications Warning	Servo G5, G5 Linear, and Servo 1S	I576 I577 I586

Event code	Event name	Functional classification	Reference
84B10000 hex	EtherCAT State Change Error	Servo G5, G5 Linear, and Servo 1S	I576 I577 I586 I621
84B20000 hex	EtherCAT Illegal State Change Error	Servo G5, G5 Linear, and Servo 1S	I576 I577 I586 I621
84B30000 hex	Communications Synchronization Error	Servo G5 and G5 Linear	I576 I577
84B40000 hex	Synchronization Error	Servo G5, G5 Linear, and Servo 1S	I576 I577 I586 I621
84B50000 hex	Sync Manager WDT Error	Servo G5, G5 Linear, and Servo 1S	I576 I577 I586 I621
84B60000 hex	ESC Initialization Error	Servo G5, G5 Linear, and Servo 1S	I576 I577 I586 I621
84B70000 hex	Slave Unit Verification Error	Servo G5, G5 Linear, and Servo 1S	I576 I577 I586 I621
84B80000 hex	Communications Setting Error	Servo G5 and G5 Linear	I576 I577
84B90000 hex	Synchronization Interruption Error	Servo G5, G5 Linear, and Servo 1S	I576 I577 I586 I621
84BA0000 hex	Bootstrap State Transition Request Error	Servo 1S	I586 I621
84C00000 hex	NX Unit Communications Timeout	NX-series EtherCAT Coupler Unit	W519
84C10000 hex	NX Unit Initialization Error	NX-series EtherCAT Coupler Unit	W519
84C50000 hex	NX Unit Startup Error	NX-series EtherCAT Coupler Unit	W519
84D00000 hex	SSI Communications Error	NX-series Position Interface Units	W524
84E00000 hex	IP Address Duplication Error	CJ-series EtherNet/IP Units	W495
84E10000 hex	BOOTP Server Error	CJ-series EtherNet/IP Units	W495
84E20000 hex	Link OFF Error	CJ-series EtherNet/IP Units	W495
84F00000 hex	NX Bus I/O Communications Stopped	NX-series Safety Control Unit	Z930
84F10000 hex	NX Bus I/O Communications Stopped	NX-series Safety Control Unit	Z930
85000000 hex	Process Data WDT Error	NX-series EtherCAT Coupler Unit	W519

Event code	Event name	Functional classification	Reference
85010000 hex	Synchronization Interruption Error	NX-series EtherCAT Coupler Unit	W519
85020000 hex	Synchronization Error	NX-series EtherCAT Coupler Unit	W519
85030000 hex	Communications Synchronization Error	NX-series EtherCAT Coupler Unit	W519
85100000 hex	DB Connection Disconnected Error	DB Connection Service	W527
852C0000Hex	I/O Communication Error	CJ-series EtherCAT Slave Unit	W542
85400000 hex	Data Discarded Due to Full Internal Buffer	NX-series Communications Interface Units	W540
85410000 hex	Parity Error	NX-series Communications Interface Units	W540
85420000 hex	Framing Error	NX-series Communications Interface Units	W540
85430000 hex	Overrun Error	NX-series Communications Interface Units	W540
85500000 hex	NX Bus Communications Error	NX Bus	W503
85510000 hex	NX Unit Communications Timeout	NX Bus	W503
85520000 hex	NX Unit Initialization Error	NX Bus	W503
85530000 hex	NX Unit Startup Error	NX Bus	W503
85540000 hex	NX Bus I/O Communications Stopped Due to Another Event	NX Bus	W503
85600000 hex	OPC UA Client Connection Rejected	OPC UA Server Function	W503
85800000 hex	EtherCAT Slave Communications Error	General Robot Control	O037
85A00000 hex	X Bus Unit Startup Error	X Bus	W503
85A10000 hex	X Bus Unit Communications Error	X Bus	W503
85D00000 hex	IP Address Duplication Error	NX-series EtherNet/IP Unit	W627
85D10000 hex	BOOTP Server Connection Error	NX-series EtherNet/IP Unit	W627
85D40000 hex	Packet Discarded Due to Full Reception Buffer	NX-series EtherNet/IP Unit	W627
85D50000 hex	Link OFF Detected	NX-series EtherNet/IP Unit	W627
87800000 hex	EtherCAT Slave Communications Error	CNC Function	O030
88080000 hex	PLC Link Communications Error	FH/FZ5 Series Vision System	Z342
88100000 hex	Communications Synchronization Error	Servo 1S	I586 I621
88120000 hex	Safety Communications Timeout	Servo 1S	I586 I621
88130000 hex	Analog Option Board Startup Error	Built-in I/O and Option Boards	W503
88140000 hex	Analog Option Board Communications Error	Built-in I/O and Option Boards	W503
90010000 hex	Clock Changed	Errors Related to Controller Operation	W503

Event code	Event name	Functional classification	Reference
90020000 hex	Time Zone Changed	Errors Related to Controller Operation	W503
90030000 hex	Online Connection Started	Errors Related to Controller Operation	W503
90040000 hex	Online Connection Ended	Errors Related to Controller Operation	W503
90050000 hex	User Program/Controller Configurations and Setup Downloaded	Errors Related to Controller Operation	W503
90070000 hex	Online Edits Transferred	Errors Related to Controller Operation	W503
90080000 hex	Variable Changed to TRUE with Forced Refreshing	Errors Related to Controller Operation	W503
90090000 hex	Variable Changed to FALSE with Forced Refreshing	Errors Related to Controller Operation	W503
900A0000 hex	All Forced Refreshing Cleared	Errors Related to Controller Operation	W503
900B0000 hex	Memory All Cleared	Errors Related to Controller Operation	W503
900C0000 hex	Event Log Cleared	Errors Related to Controller Operation	W503
900F0000 hex	Automatic Transfer Completed	Errors Related to Controller Operation	W503
90110000 hex	Power Turned ON	Errors Related to Controller Operation	W503
90120000 hex	Power Interrupted	Errors Related to Controller Operation	W503
90130000 hex	Operation Started	Errors Related to Controller Operation	W503
90140000 hex	Operation Stopped	Errors Related to Controller Operation	W503
90150000 hex	Reset Executed	Errors Related to Controller Operation	W503
90160000 hex	User Program Execution ID Write	Errors Related to Controller Operation	W503
90170000 hex	Authentication Setting Transferred	Errors Related to Controller Operation	W503
90180000 hex	All Controller Errors Cleared	Errors Related to Controller Operation	W503
90190000 hex	Forced Refreshing Cleared	Errors Related to Controller Operation	W503
901A0000 hex	Backup Started	Errors Related to Controller Operation	W503
901B0000 hex	Backup Completed	Errors Related to Controller Operation	W503
901C0000 hex	Restore Operation Started	Errors Related to Controller Operation	W503
901D0000 hex	Restore Operation Completed	Errors Related to Controller Operation	W503
90200000 hex	SD Memory Card Program Transfer Started	Errors Related to Controller Operation	W503

Event code	Event name	Functional classification	Reference
90210000 hex	SD Memory Card Program Transfer Completed	Errors Related to Controller Operation	W503
90290000 hex	Project Unit Version Changed	Errors Related to Controller Operation	W503
902A0000 hex	Change to RUN Mode Commanded	Errors Related to Controller Operation	W503
902B0000 hex	Change to PROGRAM Mode Commanded	Errors Related to Controller Operation	W503
902C0000 hex	Access Rights Forcibly Released	Errors Related to Controller Operation	W503
902D0000 hex	CPU Unit Name Changed	Errors Related to Controller Operation	W503
902E0000 hex	CPU Unit Write Protected	Errors Related to Controller Operation	W503
902F0000 hex	Operation Mode Change Setting Written	Errors Related to Controller Operation	W503
90300000 hex	Backup Start Commanded	Errors Related to Controller Operation	W503
90310000 hex	Restore Start Commanded	Errors Related to Controller Operation	W503
90320000 hex	Firmware Update Prohibition Setting Changed	Errors Related to Controller Operation	W503
90330000 hex	Start Instruction of Omron Maintenance	Errors Related to Controller Operation	W503
90340000 hex	End Instruction of Omron Maintenance	Errors Related to Controller Operation	W503
90400000 hex	Event Log Cleared	NX-series EtherCAT Coupler Units, NX-series Digital I/O Units, NX-series Analog I/O Units, NX-series System Units, NX-series Position Interface Units, NX-series Communications Interface Units, NX-series Safety Control Unit, NX-series Load Cell Input Units, NX-series IO-Link Master Units, NX-series Temperature Control Units, and NX-series High-speed Counter Units	W519 W521 W522 W566 W523 W524 W540 Z930 W565 W570 H228 W647
90420000 hex	Restart Executed	NX-series EtherCAT Coupler Unit	W519
90430000 hex	Memory All Cleared	NX-series EtherCAT Coupler Unit and NX-series Safety Control Unit	W519 Z930
90460000 hex	Safety Data Logging Started	Errors Related to Controller Operation	W503
90470000 hex	Safety Data Logging Aborted	Errors Related to Controller Operation	W503
90480000 hex	Safety Data Logging Completed	Errors Related to Controller Operation	W503
90A00000 hex	Unit Restarted	Servo 1S	I586

Event code	Event name	Functional classification	Reference
90A20000 hex	User Authentication Enabled	Errors Related to Controller Operation	W503
90A30000 hex	User Authentication Disabled	Errors Related to Controller Operation	W503
90A40000 hex	User Added	Errors Related to Controller Operation	W503
90A50000 hex	User Deleted	Errors Related to Controller Operation	W503
90A60000 hex	User Authority Changed	Errors Related to Controller Operation	W503
90A70000 hex	User Password Changed	Errors Related to Controller Operation	W503
90A80000 hex	User Password Validity Period Control Enabled	Errors Related to Controller Operation	W503
90A90000 hex	User Password Validity Period Control Disabled	Errors Related to Controller Operation	W503
90AA0000 hex	User Password Validity Period Changed	Errors Related to Controller Operation	W503
90AB0000 hex	User Authentication Operation Lock Enabled	Errors Related to Controller Operation	W503
90AC0000 hex	User Authentication Operation Lock Disabled	Errors Related to Controller Operation	W503
90AD0000 hex	User Authentication Operation Lock Time Changed	Errors Related to Controller Operation	W503
90AE0000 hex	Operation Authority Verification Enabled	Errors Related to Controller Operation	W503
90AF0000 hex	Operation Authority Verification Disabled	Errors Related to Controller Operation	W503
90B00000 hex	Operation Authority Password Changed	Errors Related to Controller Operation	W503
90B10000 hex	Operation Authority for Password Input Omission Changed	Errors Related to Controller Operation	W503
90B20000 hex	Operation Authority Verification Operation Lock Enabled	Errors Related to Controller Operation	W503
90B30000 hex	Operation Authority Verification Operation Lock Disabled	Errors Related to Controller Operation	W503
90B40000 hex	Operation Authority Verification Operation Lock Time Changed	Errors Related to Controller Operation	W503
90B50000 hex	User Password Expiration Notice Enabled	Errors Related to Controller Operation	W503
90B60000 hex	User Password Expiration Notice Disabled	Errors Related to Controller Operation	W503
90B70000 hex	Days for Prior Notice of User Password Expiration Changed	Errors Related to Controller Operation	W503
90B80000 hex	Secure Communications Version Changed	Errors Related to Controller Operation	W503
91000000 hex	X Bus Unit Settings Downloaded	X Bus Unit	W503
91020000 hex	X Bus Unit Settings All Cleared	X Bus Unit	W503
91030000 hex	All Errors Cleared	X Bus Unit	W503
91040000 hex	Event Log Cleared	X Bus Unit	W503

Event code	Event name	Functional classification	Reference
91050000 hex	Power Turned ON	X Bus Unit	W503
91060000 hex	Power Interrupted	X Bus Unit	W503
94010000 hex	Tag Data Link Download Started	EtherNet/IP	W503
94020000 hex	Tag Data Link Download Finished	EtherNet/IP	W503
94030000 hex	Tag Data Link Stopped	EtherNet/IP	W503
94040000 hex	Tag Data Link Started	EtherNet/IP	W503
94050000 hex	Link Detected	EtherNet/IP	W503
94060000 hex	Restarting Ethernet Port	EtherNet/IP	W503
94070000 hex	Tag Data Link All Run	EtherNet/IP	W503
94080000 hex	IP Address Fixed	EtherNet/IP	W503
94090000 hex	BOOTP Client Started	EtherNet/IP	W503
940A0000 hex	FTP Server Started	EtherNet/IP	W503
940B0000 hex	NTP Client Started	EtherNet/IP	W503
940C0000 hex	SNMP Started	EtherNet/IP	W503
940E0000 hex	Secure Socket Communications Log Started/Stopped	EtherNet/IP	W503
940F0000 hex	Secure Socket Communications Log Saving Failed	EtherNet/IP	W503
94100000 hex	Access to Secure Socket Setting	EtherNet/IP	W503
94110000 hex	Access to Secure Socket Setting	EtherNet/IP	W503
94120000 hex	Change or Reading of Secure Socket Setting	EtherNet/IP	W503
94130000 hex	IP Address Changed	EtherNet/IP	W503
94140000 hex	SNMP Settings Changed	EtherNet/IP	W503
94150000 hex	Subnet Mask Changed	EtherNet/IP	W503
94200000 hex	Notice of Insufficient Travel Distance to Achieve Blending Transit Velocity	General Motion Control	W503
94210000 hex	Error Clear from MC Test Run Tab Page	General Motion Control	W503
94220000 hex	Slave Error Code Report	General Motion Control	W503
94230000 hex	Transition Parameter Adjusted	NJ Robotics Function	W539
94400000 hex	Slave Disconnected	EtherCAT Master	W503
94410000 hex	Slave Connected	EtherCAT Master	W503
94430000 hex	Error Reset	EtherCAT Master	W503
94440000 hex	Slave Disabled	EtherCAT Master	W503
94450000 hex	Slave Enabled	EtherCAT Master	W503
94500000 hex	EtherCAT Diagnosis/Statistics Log Started	EtherCAT Master	W503
94510000 hex	EtherCAT Diagnosis/Statistics Log Ended	EtherCAT Master	W503
94520000 hex	Wait for Cycling Power Supply	EtherCAT Master	W503
94600000 hex	I/O Check Execution Started	NX-series EtherCAT Coupler Unit	W519
94D00000 hex	Tuning Parameter Updated	NX-series Temperature Control Units	H228
94D10000 hex	Related Parameters Initialized	NX-series Temperature Control Units	H228

Event code	Event name	Functional classification	Reference
94F00000 hex	Tuning Parameter Automatically Updated	NX-series Temperature Control Units	H228
951E0000 hex	Sysmac Studio Communications Connection Timeout	NX-series Safety Control Unit	Z930
951F0000 hex	Clear All Memory Rejected	NX-series Safety Control Unit	Z930
95300000 hex	DB Connection Service Started	DB Connection Service	W527
95310000 hex	DB Connection Service Stopped	DB Connection Service	W527
95320000 hex	DB Connection Service Shut-down	DB Connection Service	W527
95330000 hex	Spool Cleared	DB Connection Service	W527
95340000 hex	Operation to Start DB Connection Service	DB Connection Service	W527
95350000 hex	Operation to Stop DB Connection Service	DB Connection Service	W527
95360000 hex	Operation to End DB Connection Service	DB Connection Service	W527
95370000 hex	Operation to Clear Spool Memory	DB Connection Service	W527
95380000 hex	Operation to Clear Operation Log	DB Connection Service	W527
95390000 hex	Operation to Start Debug Logging	DB Connection Service	W527
953A0000 hex	Operation to Stop Debug Logging	DB Connection Service	W527
95420000 hex	GEM Service Started	GEM Services	W528
95430000 hex	Shutdown Completed	GEM Services	W528
95440000 hex	GEM Setting Data Changed	GEM Services	W528
95450000 hex	Valid SD Memory Card	GEM Services	W528
95720000 hex	Automation Playback Settings Changed	Errors Related to Controller Operation	W503
95730000 hex	Variable Sampling Started	Errors Related to Controller Operation	W503
95740000 hex	Variable Sampling Stopped	Errors Related to Controller Operation	W503
95750000 hex	Variable Log Output Completed	Errors Related to Controller Operation	W503
95760000 hex	Variable Log Overwritten	Errors Related to Controller Operation	W503
95770000 hex	Upper Limit of Variable Sampling	Errors Related to Controller Operation	W503
95780000 hex	Variable Log Output Completed	Errors Related to Controller Operation	W503
95790000 hex	Upper Limit of Variable Sampling	Errors Related to Controller Operation	W503
957A0000 hex	Variable Log Save Not Possible	Errors Related to Controller Operation	W503
95800000 hex	NX Bus Restart Executed	NX Bus	W503
95810000 hex	NX Unit Memory All Cleared	NX Bus	W503
95D00000 hex	OPC UA Server Started	OPC UA Server Function	W503
95D10000 hex	OPC UA Server Stopped	OPC UA Server Function	W503

Event code	Event name	Functional classification	Reference
95D20000 hex	Server Certificate Generated	OPC UA Server Function	W503
95D30000 hex	Client Certificate Discarded	OPC UA Server Function	W503
95D40000 hex	OPC UA Server Certificate and Security Profile Cleared	OPC UA Server Function	W503
95D60000 hex	Client Certificate Added	OPC UA Server Function	W503
95D70000 hex	Client Certificate Deleted	OPC UA Server Function	W503
95D80000 hex	Client Certificate Moved	OPC UA Server Function	W503
95D90000 hex	Client Certificate Revocation List Added	OPC UA Server Function	W503
95DA0000 hex	Client Certificate Revocation List Deleted	OPC UA Server Function	W503
95DB0000 hex	Server Certificate Regenerated	OPC UA Server Function	W503
96040000 hex	V+ Program Error	General Robot Control	O037
96050000 hex	V+ Program Warning	General Robot Control	O037
96060000 hex	V+ Program Information	General Robot Control	O037
96090000 hex	Robot Manual Mode Started	General Robot Control	O037
960A0000 hex	Robot Auto Mode Started	General Robot Control	O037
96200000 hex	Security Settings Transferred	OPC UA Server Function	W503
96210000 hex	Execution Log Cleared	OPC UA Server Function	W503
96220000 hex	CA Certificate Added	OPC UA Server Function	W503
96230000 hex	CA Certificate Deleted	OPC UA Server Function	W503
96240000 hex	CA Certificate Revocation List Added	OPC UA Server Function	W503
96250000 hex	CA Certificate Revocation List Deleted	OPC UA Server Function	W503
96260000 hex	Client Certificate or CA Certificate Changed	OPC UA Server Function	W503
96440000 hex	Link Detected	NX-series EtherNet/IP Unit	W627
96450000 hex	Restarting Ethernet Port	EtherNet/IP	W503
96470000 hex	IP Address Fixed	NX-series EtherNet/IP Unit	W627
96480000 hex	BOOTP Client Started	NX-series EtherNet/IP Unit	W627
964B0000 hex	SNMP Started	NX-series EtherNet/IP Unit	W627
96500000 hex	IP Address Changed	NX-series EtherNet/IP Unit	W627
96510000 hex	SNMP Settings Changed	NX-series EtherNet/IP Unit	W627
96520000 hex	Subnet Mask Changed	NX-series EtherNet/IP Unit	W627
97800000 hex	Slave Error Code Report	CNC Function	O030
97810000 hex	Software Limit Path Limited	CNC Function	O030
97820000 hex	CNC Function System Information	CNC Function	O030
97830000 hex	Velocity Control Command Value Saturated	CNC Function	O030
98010000 hex	Absolute Value Cleared	Servo G5	I576
98020000 hex	Position Data Initialized	Servo G5 and G5 Linear	I576 I577
98200000 hex	Absolute Value Cleared	Servo 1S	I586 I621
98210000 hex	STO Detected	Servo 1S	I586
98220000 hex	Memory All Cleared	Servo 1S	I586

Event code	Event name	Functional classification	Reference
98230000 hex	Motor Rotation Direction Selection Nonconformity	Servo 1S	I621
98240000 hex	Event Log Cleared	Servo 1S	I586
98250000 hex	STO Detected	Servo 1S	I621

A-4 Events in Order of Event Codes

A

A-4-2 Error Table

A-5 Applicable Range of the HMI Troubleshooter

Whether the HMI Troubleshooter can be used depends on the combination of the HMI and the CPU Unit.

Also, the system configuration elements that are supported by the HMI Troubleshooter are different for each Troubleshooter function.

A-5-1 Combinations of HMIs and CPU Units That Enable Using the Troubleshooter

Whether the HMI Troubleshooter can be used depends on the combination of the HMI and the CPU Unit.

● NA-series HMIs

The models of HMIs on which the Troubleshooter can be used are given in the following table.



Precautions for Correct Use

The troubleshooter function of NA-series HMIs cannot be used when the CPU Unit is set to secure communications version 2.

HMI	Model
NA5	NA5-□

Whether the Troubleshooter can be used for specific system versions of the above HMI models is given in the following table.

HMI system version	Connected CPU Unit	
	NX-series CPU Unit	NJ-series CPU Unit
Version 1.02 or higher	Can be used.	
Version 1.01 or lower	The HMI does not have a Troubleshooter.	

● NS-series HMIs

The models of HMIs on which the Troubleshooter can be used are given in the following table.

HMI	Model
NS8, NS10, NS12, and NS15	NS□-T□01-V2 (The V2 versions have an Ethernet port.)
NS5	NS5-□Q11-V2 (These models have expanded memory and an Ethernet port.)
NSJ8, NSJ10, and NSJ12	All models
NSJ5	NSJ5-□Q11-□ (These models have expanded memory and an Ethernet port.)

Whether the Troubleshooter can be used for specific system versions of the above HMI models is given in the following table.

HMI system version	Connected CPU Unit	
	NX-series CPU Unit	NJ-series CPU Unit
Version 8.9 or higher	Can be used.	
Version 8.5 to 8.8	Cannot be used.	Can be used.
Version 8.4 or lower	The HMI does not have a Troubleshooter.	

A

A-5-2 System Configuration Elements Supported by the Troubleshooter

The troubleshooting functions that you can use on the HMI depend on the system configuration element.

Refer to the following manuals for the NA-series HMIs and NS-series HMIs for the system configuration elements that are supported by the HMI Troubleshooter.

- *NA-series Programmable Terminal Hardware User's Manual (Cat. No. V117)*
- *NS-series Programmable Terminals Programming Manual (Cat No. V073)*



Precautions for Correct Use

On the NA-series HMI, operation related to the NX Bus Function Module is limited as follows. Use the troubleshooting function of Sysmac Studio as necessary.

- Current errors in the NX bus master are displayed, but NX Bus Function Module is not displayed at Source. Current errors in NX Units mounted to the CPU Unit are not displayed.
 - Resetting all errors is the only way to reset current errors.
 - Event logs for the NX bus master are displayed, but NX Bus Function Module is not displayed at Source. Event logs for NX Units mounted to the CPU Unit are not displayed.
 - Event logs for the NX bus master can be deleted, but event logs for NX Units mounted to the CPU Unit cannot be deleted.
-



Precautions for Correct Use

On the NS-series HMI, operation related to the NX Bus Function Module is limited as follows. Use the troubleshooting function of Sysmac Studio as necessary.

- Current errors are not displayed.
 - Resetting all errors is the only way to reset current errors.
 - Event logs are not displayed.
 - Event logs for the NX bus master can be deleted, but event logs for NX Units mounted to the CPU Unit cannot be deleted.
-

A-6 Correspondence of Events between Project Unit Version Earlier than 1.40 and Project Unit Version 1.40 or Later

Events that occur in CPU Units are determined by the CPU unit versions, and they do not change even if you change the project unit versions*1.

*1. In this manual, the unit version set for a project is called "project unit version". A project unit version is set for a project in the Select Device Area of Project Properties Dialog Box on the Sysmac Studio.

However, some events that occur in the EtherCAT Master Function Module differ between project unit version earlier than 1.40 and project unit version 1.40 or later. When you obtain the event code of an event that occurred by the host system and implement a processing, consider that the event code is different according to the setting of the project unit version and design the host system.

The following table shows the correspondence of events between project unit version earlier than 1.40 and project unit version 1.40 or later.

Function module	Type of correspondence	Project unit version	
		Version earlier than 1.40	Version 1.40 or later
EtherCAT Master Function Module	Events changed for project unit version 1.40 or later	EtherCAT Slave Backup Failed (Version 1.03 or later) (102F0000 hex)	EtherCAT Slave Backup Failed (10460001 hex)
		EtherCAT Slave Restore Operation Failed (Version 1.03 or later) (10300000 hex)	EtherCAT Slave Restore Operation Failed (10470002 hex)
		Network Configuration Error (84210000 hex)	Incorrect Wiring Detected (843C0000 hex)
		Network Configuration Verification Error (84220000 hex)	Network Configuration Verification Error (Incorrect Wiring) (84320003 hex)
			Network Configuration Verification Error (Slave Unconnected) (84380000 hex)
			Network Configuration Verification Error (Mismatched Slave) (84330004 hex)
		Slave Initialization Error (84230000 hex)	Slave State Transition Failed (84300001 hex)
		Slave Application Error (84280000 hex)	Slave AL Status Error Detected (84360000 hex)
		Process Data Communications Error (842C0000 hex)	Illegal Slave Disconnection Detected (84310002 hex)
			Slave PDI WDT Error Detected (84340000 hex)
EtherCAT Message Error (842D0000 hex)	Illegal Mailbox Received (84350000 hex)		
Events occurred only in project unit version earlier than 1.40	MAC Address Error (14400000 hex)	None	
	EtherCAT Communications Cycle Exceeded (Version 1.10 or later) (34410000 hex)	None	



Function module	Type of correspondence	Project unit version	
		Version earlier than 1.40	Version 1.40 or later
	Events occurred only in project unit version 1.40 or later	None	Parameters Not Transferred (34420000 hex)
		None	Clock Synchronization Compensation Failed (84370000 hex)
		None	Ring Disconnection Detected (84390000 hex)
		None	Network Configuration Verification Error (Incorrect Ring Wiring) (843A0000 hex)
		None	Wait for Cycling Power Supply (94520000 hex)
	Events commonly occurred in project unit version earlier than 1.40 and project unit version 1.40 or later	Communications Controller Error (04400000 hex)	
		Slave Node Address Duplicated (24200000 hex)	
		Network Configuration Information Error (34400000 hex)	
		EtherCAT Fault (44010000 hex)	
		Controller Insufficient Memory Warning (50010000 hex)	
		Emergency Message Detected (64200000 hex)	
		Link OFF Error (84200000 hex)	
		Process Data Transmission Error (84290000 hex)	
		Process Data Reception Timeout (842B0000 hex)	
		EtherCAT Frame Not Received (Version 1.11 or later) (842E0000 hex)	
		Input Process Data Invalid Error (Version 1.13 or later) (842F0000 hex)	
		Slave Disconnected (94400000 hex)	
		Slave Connected (94410000 hex)	
		Error Reset (94430000 hex)	
		Slave Disabled (Version 1.04 or later) (94440000 hex)	
		Slave Enabled (Version 1.04 or later) (94450000 hex)	
		EtherCAT Diagnosis/Statistics Log Started (Version 1.11 or later) (94500000 hex)	
EtherCAT Diagnosis/Statistics Log Ended (Version 1.11 or later) (94510000 hex)			

A-7 Correspondence of NX Bus Events between NX102 CPU Units, NX1P2 CPU Units and Slave Terminals

The NX102 CPU Units, NX1P2 CPU Units and Slave Terminals support the mounting of NX Units. This means that NX102 CPU Units, NX1P2 CPU Units and Slave Terminals are subject to the same errors. However, with the NX102 CPU Units, NX1P2 CPU Unit, it is easier to identify the cause of an NX bus error because two or more events with more specific names may correspond to one Slave Terminal event.

The table below shows the correspondence of NX bus events, where two or more NX102 CPU Unit and NX1P2 CPU Unit events correspond to one Slave Terminal event.

NX102 CPU Unit and NX1P2 CPU Unit event	Slave Terminal event
NX Bus Function Processing Error (44440000 hex)	NX Unit Processing Error (40200000 hex)
NX Bus System Information (44450000 hex)	
Unsupported NX Unit Mounted* ¹	Unit Configuration Error, Unsupported Configuration (24A10000 hex)
Total I/O Data Size in NX Units Excessive (24D20000 hex)	
NX Unit Version Not Matched (35900000 hex)	Unit Configuration Verification Error (35010000 hex)
Unregistered NX Unit Mounted (35910000 hex)	
Registered NX Unit Not Mounted (35920000 hex)	
NX Unit Serial Number Mismatch (35930000 hex)	
NX Bus Communications Error (85500000 hex)	

- *1. This event will occur if the NX102 CPU Unit and NX1P2 CPU Unit do not support any required function of NX Units that will be released in the future.

A-8 Correction of Wiring for the EtherCAT Ring Topology Based on Event

To correct the wiring for the EtherCAT ring topology on the actual network based on the current error event in the Controller, you must handle the event in the specified order. This is efficient to clear the error and correct the wiring. This section describes how to correct the wiring for the EtherCAT ring topology on the actual network based on the current error event, and how to handle events related to ring topologies.

For restrictions on configuring a ring topology, refer to the description of the ring topology in the *NJ/NX-series CPU Unit Built-in EtherCAT Port User's Manual (Cat. No. W505)*.

The following tables describes the meanings of terms used for descriptions of correction of wiring for a ring topology.

Term	Description
Ring topology	A network configuration in which nodes are connected in a ring.
Junction Slave	A slave for branching an EtherCAT network. To be specific, it is a GX-JC03 Junction Slave and GX-JC06 Junction Slave.
Start port of the ring	A port that becomes the start point of the ring topology.
End port of the ring	A port that becomes the end point of the ring topology.
Originating slave of the ring	A slave that becomes the starting point of the ring topology. To be specific, any of the following slaves for which the cable redundancy is enabled. <ul style="list-style-type: none"> • GX-JC03 Junction Slave • One of the two slaves contained in a GX-JC06 Junction Slave
Cable redundancy	Property of being able to continue communications even if a wire is broken in the ring topology or a slave is not connected.
Cable redundancy setting	A setting operation to enable and disable the cable redundancy.
Cable redundancy status	A state in which the network has the cable redundancy. A network has the cable redundancy status when the ring topology in the actual network configuration agrees with the ring topology that is set in the network configuration information.
Ring disconnection status	A state in which there is only one wire break in a ring topology with the cable redundancy status.
Last port	For a Junction Slave, a port to which EtherCAT frames are output last. X3 for a GX-JC03 Junction Slave, and X6 for a GX-JC06 Junction Slave.
Ring line	Means a ring topology. This term is used to compare with a drop line from the ring.
Drop line from the ring	A network configuration that is branched and wired from a Junction Slave in the ring topology.
Input ports are connected	A state in which input ports are connected to each other.



Term	Description
Output ports are connected	A state in which output ports are connected to each other.

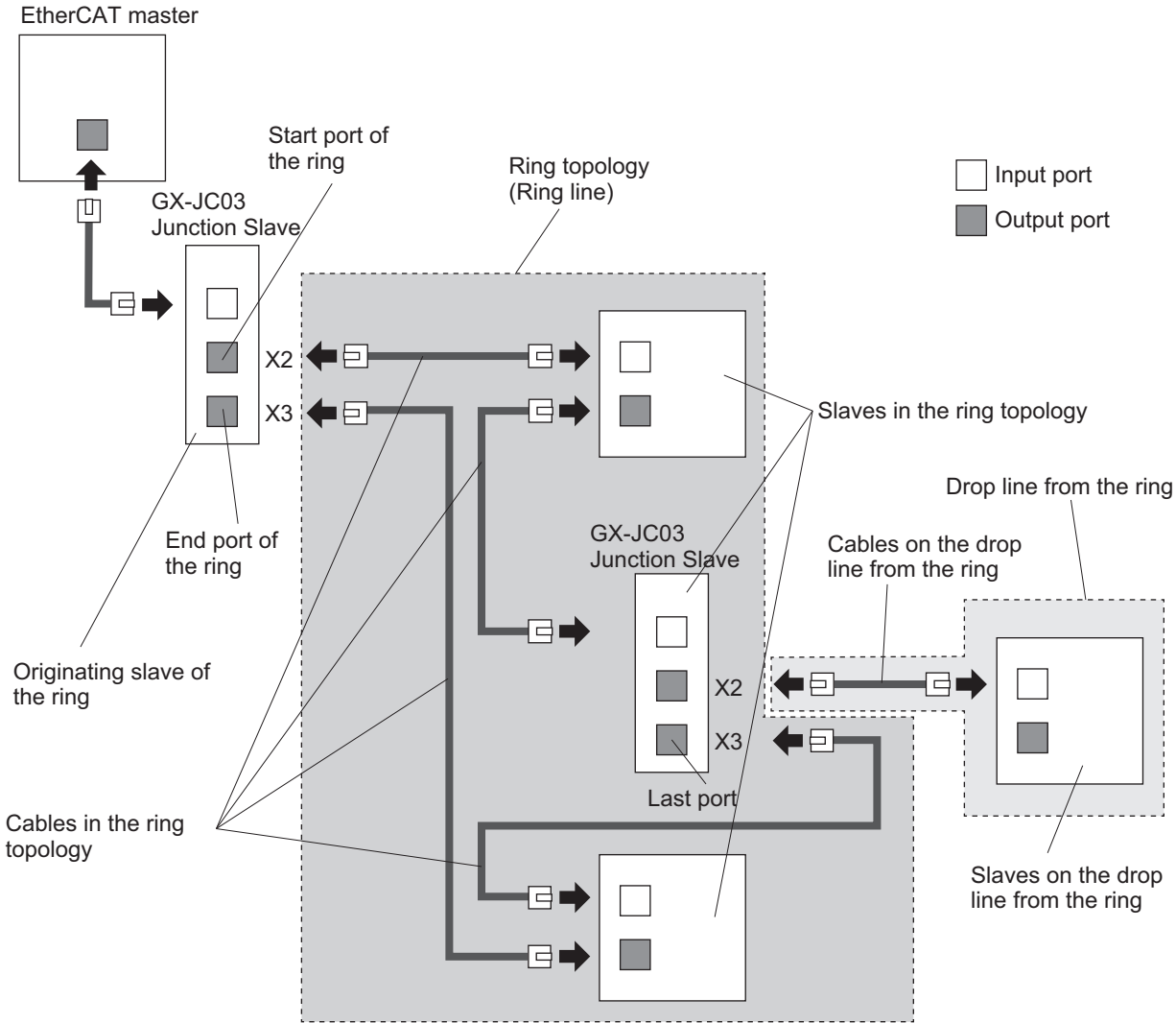

A-8-1 Flowchart of the Procedure for the Correction of Wiring for the EtherCAT Ring Topology Based on Event

The following figure shows a flowchart of operation to correct the wiring for the actual network of the EtherCAT ring topology based on the current error. Handle an event in the order shown in the flowchart.

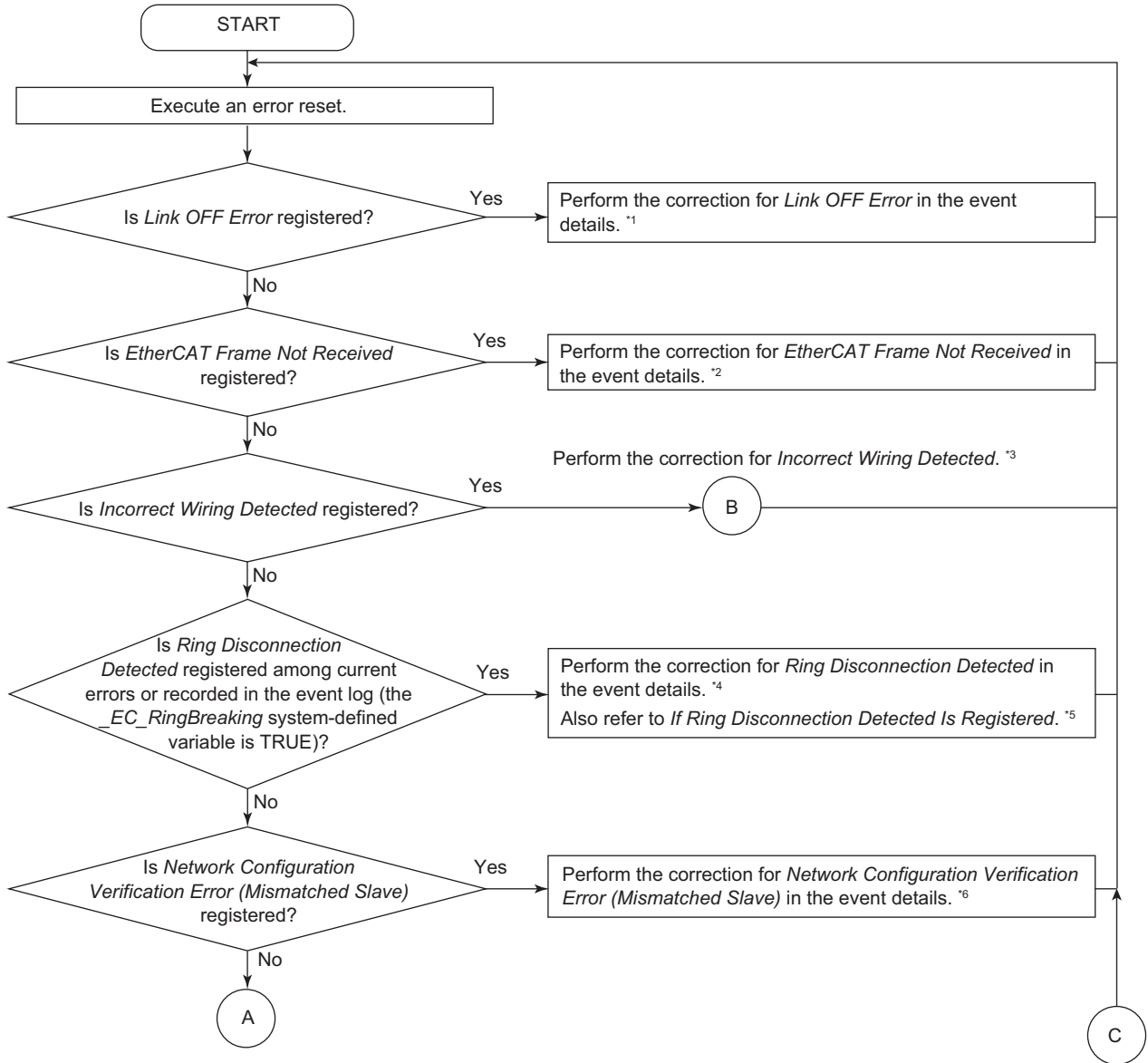

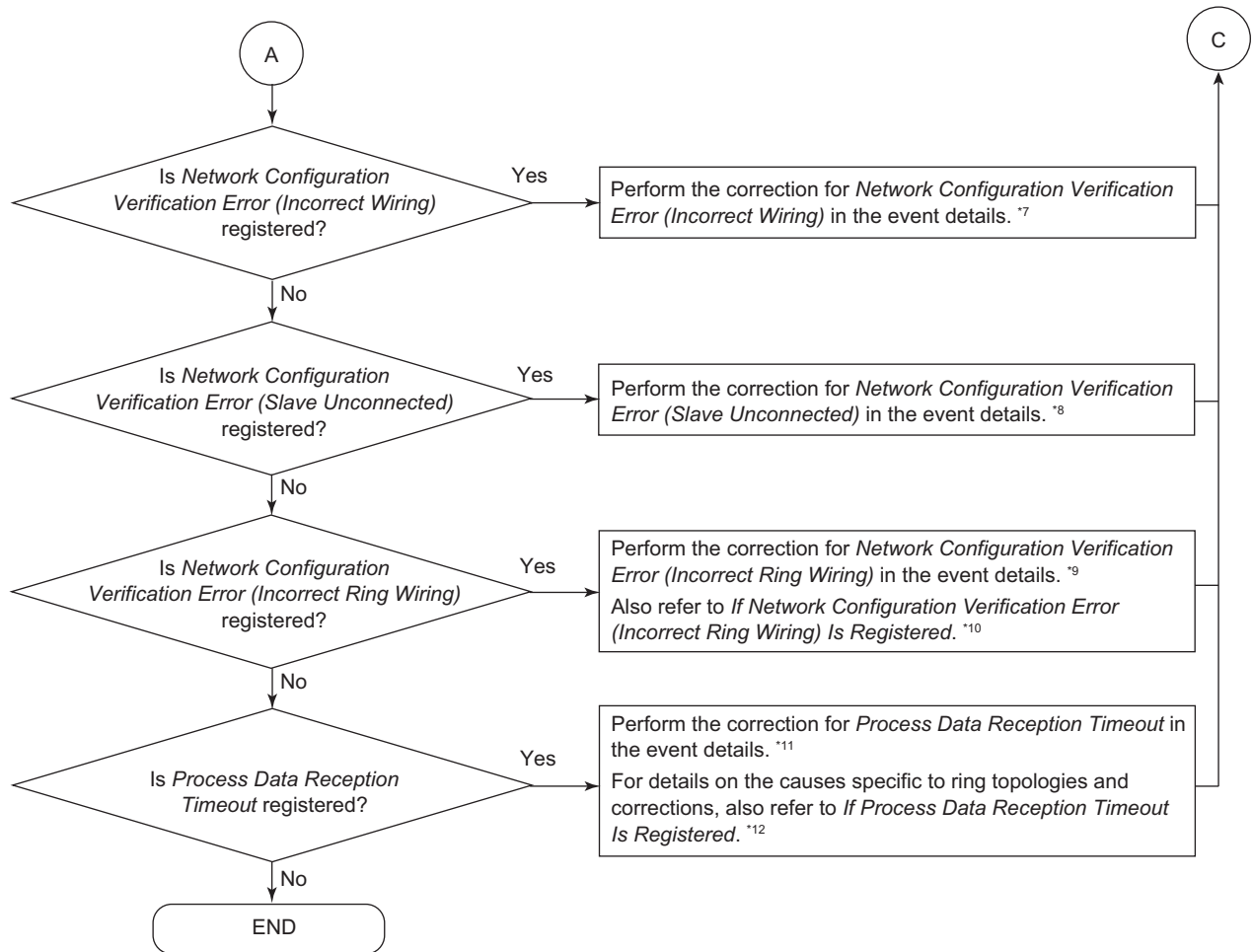

- *1. Link OFF Error (page 3-753)
- *2. EtherCAT Frame Not Received (page 3-755)
- *3. *If Incorrect Wiring Detected is Registered* on page A-310
- *4. Ring Disconnection Detected (page 3-810)
- *5. *If Ring Disconnection Detected Is Registered* on page A-317
- *6. Network Configuration Verification Error (Mismatched Slave) (page 3-785)
- *7. Network Configuration Verification Error (Incorrect Wiring) (page 3-783)
- *8. Network Configuration Verification Error (Slave Unconnected) (page 3-790)
- *9. Network Configuration Verification Error (Incorrect Ring Wiring) (page 3-792)
- *10. *If Network Configuration Verification Error (Incorrect Ring Wiring) Is Registered* on page A-318
- *11. Process Data Reception Timeout Error (page 3-770)
- *12. *If Process Data Reception Timeout Is Registered* on page A-320

A-8-2 How to Correct the Wiring of Ring Topology Based on Event

Causes and corrections based on events are displayed on the Sysmac Studio or described in *Built-in EtherCAT Port* on page 3-750. Among them, this section describes the causes and corrections related to the correction of wiring for ring topologies.

If Incorrect Wiring Detected is Registered

The following figure shows a flowchart of troubleshooting when the Incorrect Wiring Detected occurs. Handle the trouble in the order shown in the flowchart.

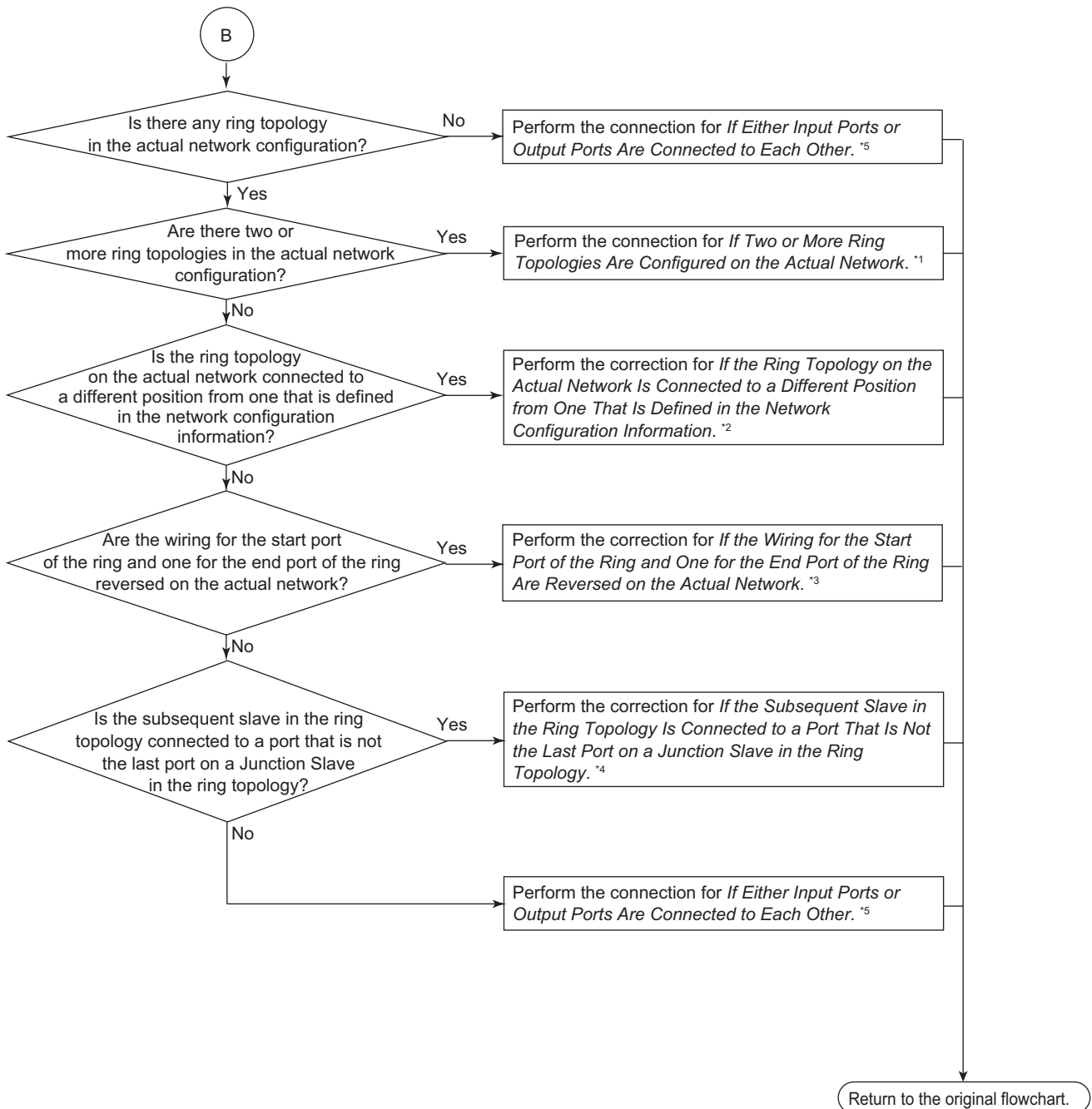

*1. *If Two or More Ring Topologies Are Configured on the Actual Network* on page A-312

*2. *If the Ring Topology on the Actual Network Is Connected to a Different Position from One That Is Defined in the Network Configuration Information* on page A-313

- *3. *If the Wiring for the Start Port of the Ring and One for the End Port of the Ring Are Reversed on the Actual Network on page A-314*
- *4. *If the Subsequent Slave in the Ring Topology Is Connected to a Port That Is Not the Last Port on a Junction Slave in the Ring Topology on page A-315*
- *5. *If Either Input Ports or Output Ports Are Connected to Each Other on page A-316*

● **If Two or More Ring Topologies Are Configured on the Actual Network**

Reduce the number of ring topologies on the actual network to one.

Use the following procedure.

1. For each ring topology set in the network configuration information, confirm the originating slave of the ring (attached information 1), the start port of the ring and the end port of the ring (attached information 2).
2. Remove the last cable of each of the ring topologies excluded in step (1) above (the cable whose ends are both connected to output ports).

An example is shown below.

Item	Description	Value
Attached information 1	Node address of the originating slave of the ring in the network configuration information	#12
Attached information 2	Names of the start port and end port of the ring in the network configuration information	X2_X3

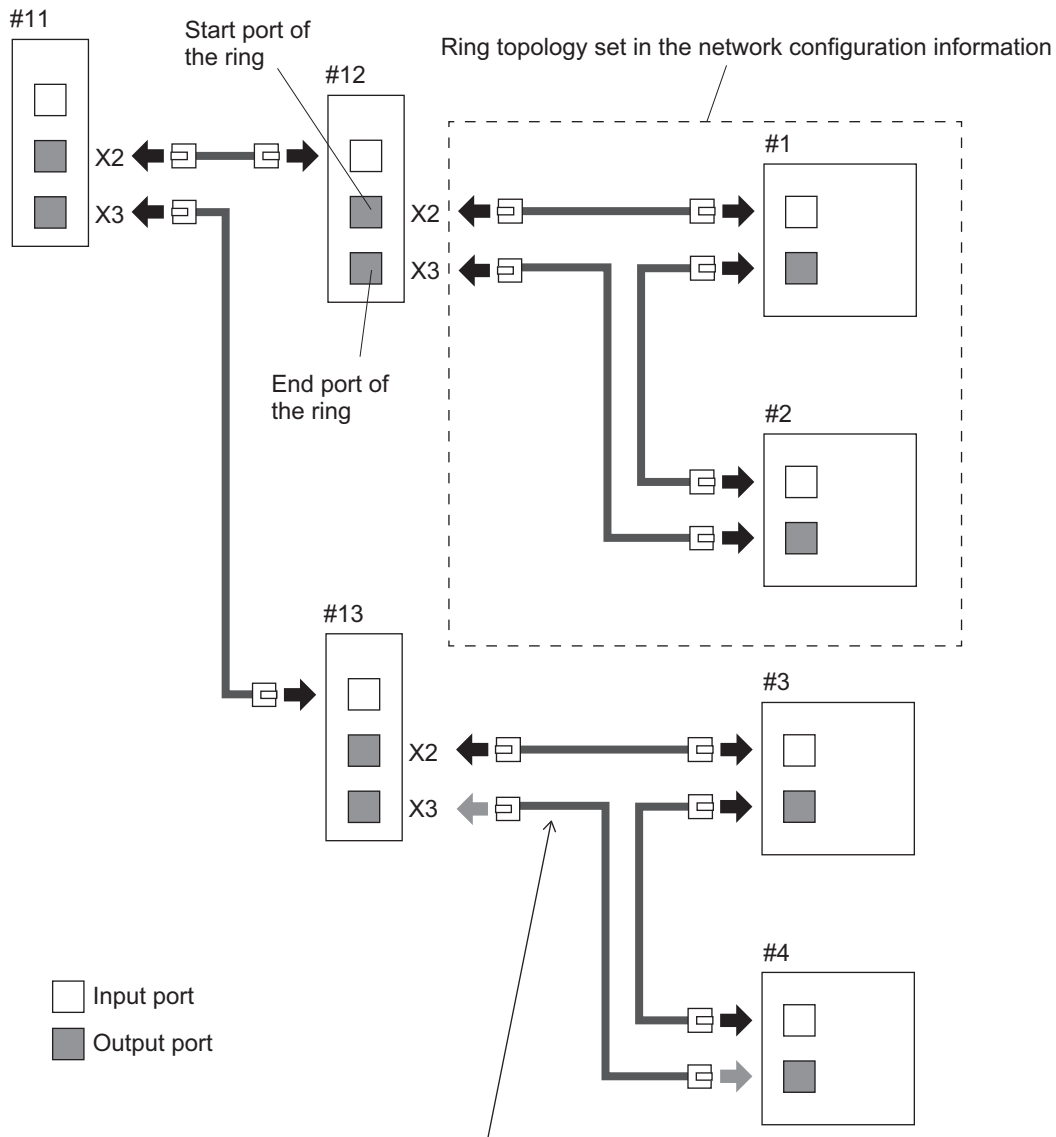

For the ring connections made to ports X2 and X3 of slave #13 not described in the attached information, remove the cable connected to X3 of the end port of the ring.

● **If the Ring Topology on the Actual Network Is Connected to a Different Position from One That Is Defined in the Network Configuration Information**

On the actual network, wire the ring topology to the start port of the ring and the end port of the ring.

Use the following procedure.

1. For each ring topology set in the network configuration information, confirm the originating slave of the ring (attached information 1), the start port of the ring and the end port of the ring (attached information 2).
2. If the ring topology on the actual network is connected to ports not as confirmed in step (1), connect the ring topology again to the start port of the ring and the end port of the ring.

An example is shown below.

Item	Description	Value
Attached information 1	Node address of the originating slave of the ring in the network configuration information	#11
Attached information 2	Names of the start port and end port of the ring in the network configuration information	X2_X3

For the ring connections made to ports X5 and X6 of slave #12, which are different from the description in the attached information, make connections again to ports X4 and X5 so that the start point and end point are correct.

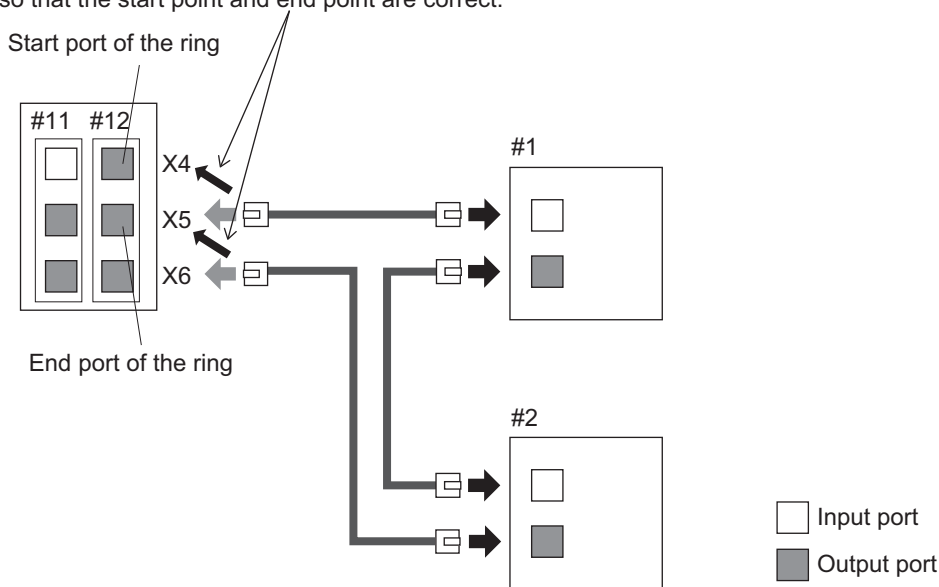

● **If the Wiring for the Start Port of the Ring and One for the End Port of the Ring Are Reversed on the Actual Network**

Reverse the wiring for the start port of the ring and one for the end port of the ring on the actual network.

Use the following procedure.

1. For each ring topology set in the network configuration information, confirm the originating slave of the ring (attached information 1), the start port of the ring and the end port of the ring (attached information 2).
2. Reverse the wiring for the start port of the ring and one for the end port of the ring confirmed in step (1) as reversed on the actual network.

An example is shown below.

Item	Description	Value
Attached information 1	Node address of the originating slave of the ring in the network configuration information	#11
Attached information 2	Names of the start port and end port of the ring in the network configuration information	X2_X3

For the ring connections made to ports X2 and X3 of slave #11, which are the same as the description in the attached information, if the start point and end point of the cable are reversed, change the positions of the cables connected to X2 and X3 and re-connect.

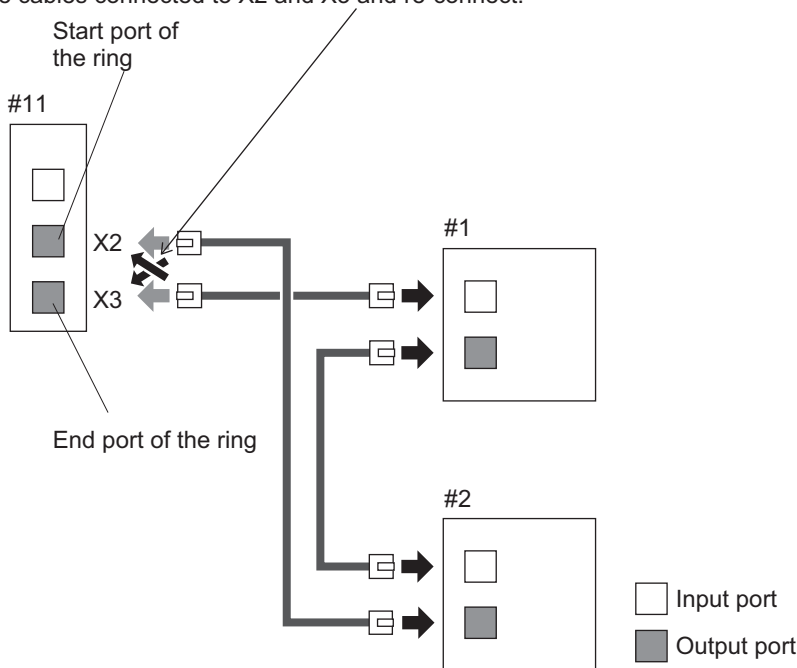

● **If the Subsequent Slave in the Ring Topology Is Connected to a Port That Is Not the Last Port on a Junction Slave in the Ring Topology**

Connect the cable for the subsequent slave on the ring line to the last port on the Junction Slave on the actual network.

Use the following procedure.

1. Check that the cable for the subsequent slave on the ring line is connected to the last port on the Junction Slave in the ring topology.
2. If the cable for the subsequent slave on the ring line is not connected to the last port on the Junction Slave in the ring topology, connect the cable for the subsequent slave on the ring line to the last port. If the cable for the drop line from the ring is connected to the last port, reconnect the cable for the drop line to a port that is not the last port.
3. If it is difficult to check as in step (1), remove the last cable in the ring topology. If the Network Configuration Verification Error (Incorrect Wiring) occurs, make corrections for the assumed causes and then connect the removed cable again.

An example is shown below.

Item	Description	Value
Attached information 1	Node address of the originating slave of the ring in the network configuration information	#11
Attached information 2	Names of the start port and end port of the ring in the network configuration information	X2_X3

Start port of the ring

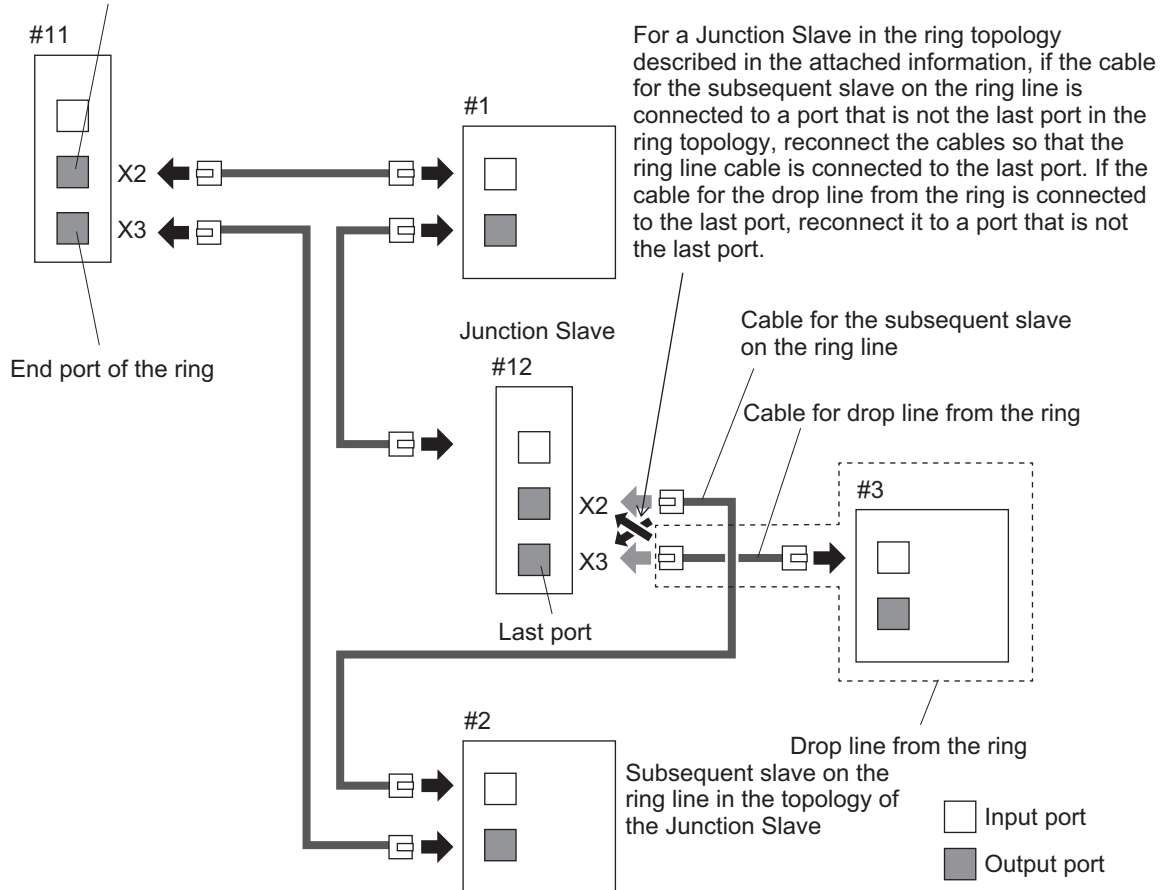

● **If Either Input Ports or Output Ports Are Connected to Each Other**

Correct cable connections on the actual network so that a cable whose ends are both connected to input ports or output ports is connected correctly to an input port on one end and to an output port on the other end.

Use the following procedure.

1. Check if input ports or output ports are not connected to each other on the actual network.
2. If input ports or output ports are connected to each other, correct the wiring so that an output port is connected to an input port.

The following shows an example where output ports are connected to each other in the ring topology.

Item	Description	Value
Attached information 1	Node address of the originating slave of the ring in the network configuration information	#11
Attached information 2	Names of the start port and end port of the ring in the network configuration information	X2_X3

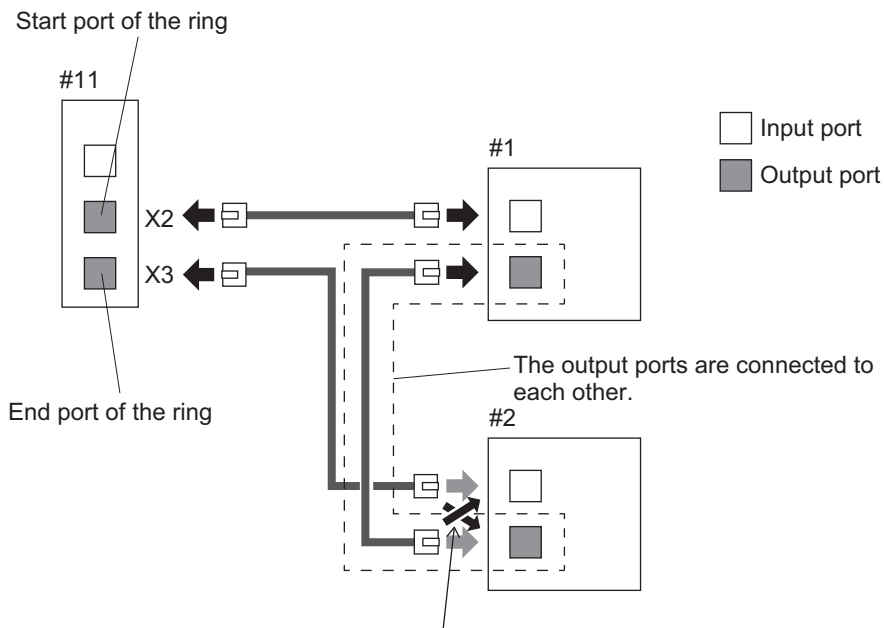

Between slaves in the ring topology connected to ports X2 and X3 of slave #11 described in the attached information, re-connect the cable whose ends are both connected to output ports to the input port in the next slave.
Also re-connect the cable connected to the above input port correctly.



Additional Information

When this event occurs, you can perform the compare and merge operation in the Sysmac Studio to possibly identify where input ports and output ports are connected to each other. If the ring topology is configured, you can disconnect the last cable of the ring topology to possibly identify where input ports or output ports are connected to each other.

If Ring Disconnection Detected Is Registered

There is an error in the cables in the ring topology. The ring topology is not in the cable redundancy status.

Remove the following causes in the cables between the slave with the node address in the attached information 1 and the subsequent slave.

- The Ethernet cable was disconnected.
- The Ethernet cable connector was disconnected.
- A non-recommended cable was used.
- The Ethernet cable is broken.
- Contact failure or part failure occurred in the connector.



Additional Information

When this event occurs, you can check the current error in the EtherCAT configuration view on the Sysmac Studio to possibly identify where a wire break occurred.

An example is shown below.

Item	Description	Value
Attached information 1	Slave node address before point of break	#2

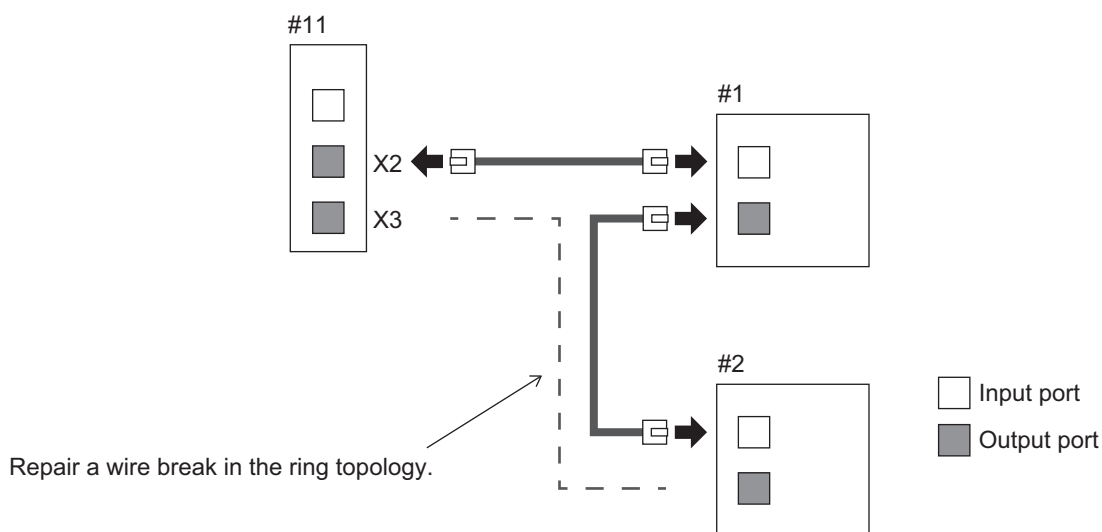

Precautions for Correct Use

The Ring Disconnection Detected is displayed among current errors when the event level is a minor fault.

When the level of the Ring Disconnection Detected is set to an observation, the Ring Disconnection Detected is not displayed among current errors. Check it with the event log. For the correction of the Ring Disconnection Detected whose level is an observation, perform the same correction as one when the level is a minor fault.

If Network Configuration Verification Error (Incorrect Ring Wiring) Is Registered

The ring topology that is not set in the network configuration information is configured on the actual network. Remove the last cable of the ring topology for which the cable redundancy is not set in the network configuration information.

Use the following procedure.

1. For each ring topology set in the network configuration information, confirm the originating slave of the ring (attached information 1), the start port of the ring and the end port of the ring (attached information 2).
2. Remove any ring topology other than those not confirmed in (1).



Additional Information

When this event occurs, you can perform the compare and merge operation in the Sysmac Studio to possibly identify incorrectly wired parts.

If you want to configure a ring topology, make the cable redundancy setting in the network configuration information when the attached information 1 is 0.

An example is shown below.

Item	Description	Value
Attached information 1	Node address of the originating slave of the ring in the network configuration information	#12
Attached information 2	Names of the start port and end port of the ring in the network configuration information	X2_X3

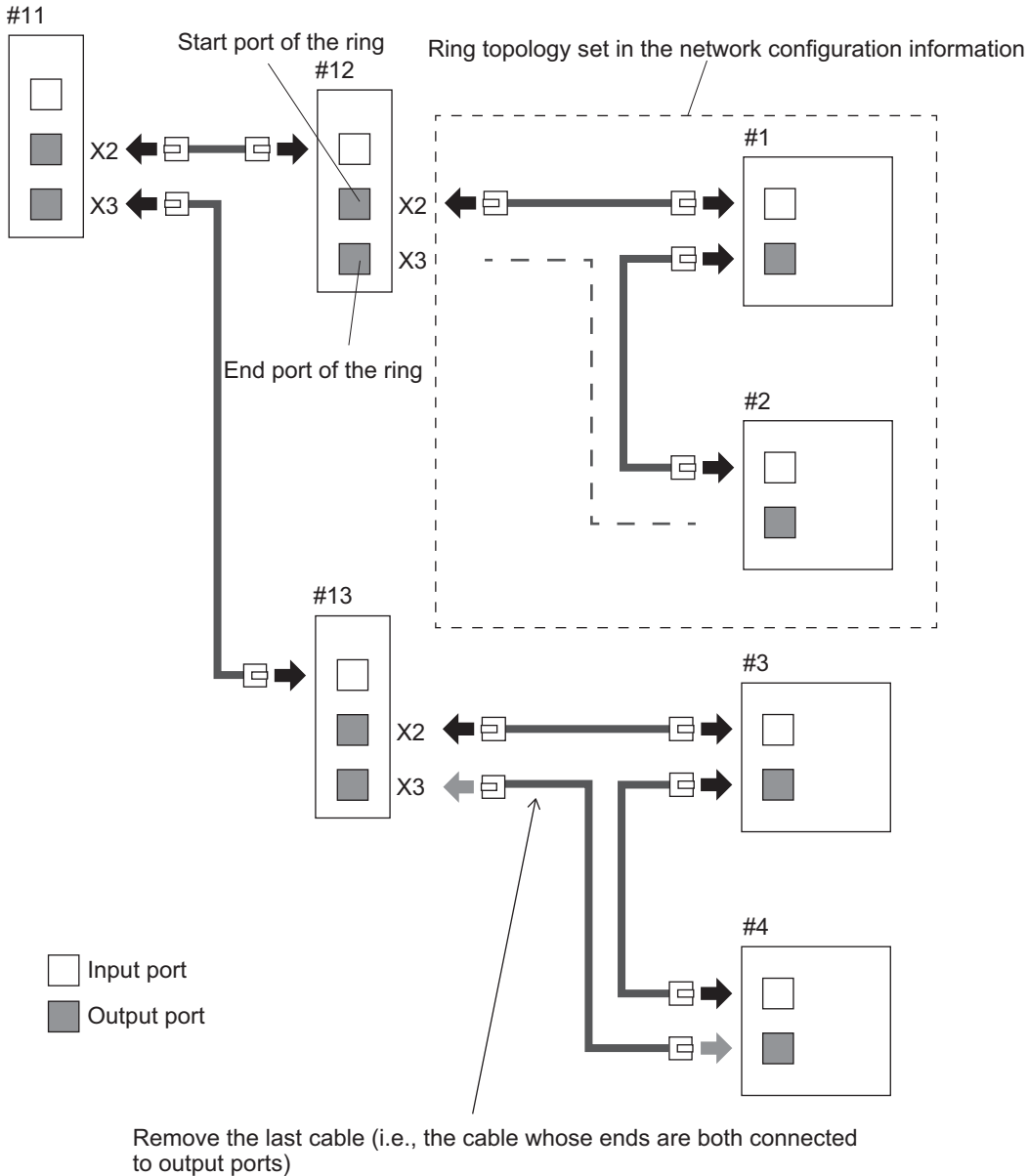

If Process Data Reception Timeout Is Registered

When the ring topology includes a slave that does not support the ring topology, the Process Data Reception Timeout also occurs after a ring disconnection or cycling the power to the slave. Check with the event log that the Ring Disconnection Detected or Illegal Slave Disconnection Detected has not occurred as the same time as the Process Data Reception Timeout.

In a ring topology, use only slaves that support the ring topology.

A-9 Operation Related to the X Bus Unit

The operation related to the Controller event of the X Bus Unit is shown below.



A-9-1 Controller Behavior for Each Level of Error

The operation and behavior of the Controller differ depending on the level of the Controller event.

Item		Level of the event occurred				
		Controller errors				Controller in-formation
		Major fault level	Partial fault level	Minor fault level	Observation	Information
Definition		An error that causes all control operations in the Controller to stop	An error that causes all control operations in one of the function modules other than the PLC Function Module to stop	An error that causes some control operations in one of the function modules to stop	An error that do not affect control	An event that is not an error but is recorded in the event log to notify the user of specific information
X Bus Unit operation	RUN (green)	---	---	Lit	Lit	Lit
	ERROR (red)	---	---	Lights or flashes at 500-ms intervals.	Not lit	Not lit
	Operating status	---	---	Operation stops or continues.	Operation continues.	Operation continues.
	Error reset	---	---	Possible or not possible.	Possible.	Possible.
	Outputs turned OFF	---	---	Yes or No	No	No
	Event logs	---	---	Recorded. (Some errors are not recorded.)	Recorded.	Recorded.

A-9-2 Operation of the Function Module When It Becomes an Event Source

Function module	Level of the error occurred			
	Major fault level	Partial fault level	Minor fault level	Observation
X Bus Unit Common Function Module	---	---	<ul style="list-style-type: none"> Operation of the X Bus Unit stops. Operation of the X Bus Unit partially continues. 	Operation continues.

Function module	Level of the error occurred			
	Major fault level	Partial fault level	Minor fault level	Observation
X Bus Ethernet Function Module	---	---	<ul style="list-style-type: none"> Ethernet communications stop (online connection with the Sysmac Studio and communication with an HMI are not possible). Ethernet communications partially stop (if the error is caused by communications other than connection with the Sysmac Studio or an HMI, online connection with the Sysmac Studio and communication with an HMI are possible). 	Ethernet communications continue.
X Bus EtherNet/IP Function Module	---	---	<ul style="list-style-type: none"> EtherNet/IP communications stop. EtherNet/IP communications partially stop. 	EtherNet/IP communications continue.



Index



Index

Numerics

1S-series..... A-150

A

Assumed cause..... 3-4
 Attached information..... 3-4
 Axes Group Errors..... 1-34
 Axis Error..... 1-34

B

Back up function..... 3-746

C

Checking for errors..... 1-11, 1-27, 2-21
 CIP communications errors..... 1-38
 CJ-series Analog I/O Units..... A-195
 CJ-series CompoNet Master Units..... A-220
 CJ-series DeviceNet Units..... A-210
 CJ-series EtherCAT Slave Units..... A-222
 CJ-series EtherNet/IP Units..... A-217
 CJ-series High-speed Counter Units..... A-203
 CJ-series ID Sensor Units..... A-200
 CJ-series Process I/O Units..... A-198
 CJ-series Serial Communications Units..... A-204
 CJ-series Temperature Control Units..... A-199
 CJ1W-AD041-V1/AD081-V1..... A-195
 CJ1W-AD042..... A-195
 CJ1W-AD04U..... A-198
 CJ1W-CRM21..... A-220
 CJ1W-CT021..... A-203
 CJ1W-DA021/DA041..... A-195
 CJ1W-DA042V..... A-195
 CJ1W-DA08V/DA08C..... A-195
 CJ1W-DRM21..... A-210
 CJ1W-ECT21..... A-222
 CJ1W-EIP21..... A-217
 CJ1W-EIP21S..... A-217
 CJ1W-MAD42..... A-195
 CJ1W-PDC15..... A-198
 CJ1W-PH41U..... A-198
 CJ1W-SCU22..... A-204
 CJ1W-SCU32..... A-204
 CJ1W-SCU42..... A-204
 CJ1W-TC003..... A-199
 CJ1W-TC004..... A-199
 CJ1W-TC103..... A-199
 CJ1W-TC104..... A-199
 CJ1W-V680C11..... A-200
 CJ1W-V680C12..... A-200
 communications port errors..... 1-38, 1-42
 Communications port errors..... 1-38
 Controller errors..... 1-17

Controller Event Times..... 1-15
 Controller events..... 1-12
 Controller events sources..... 1-15
 Controller information..... 1-17
 Correction..... 3-4
 CPU Unit Error..... 1-10, 2-9
 CPU Unit operating status..... 1-6, 1-8
 CPU Unit Reset..... 1-9, 2-8
 CPU Unit Watchdog Timer Error..... 1-9, 2-9

D

DB connection instructions..... A-6
 DB connections service..... A-2
 Detection timing..... 3-4

E

E3NW-ECT..... A-192
 E3X..... A-191
 error code
 basic instructions..... 3-46, 3-234
 motion control instruction..... 3-498, 3-567
 error codes..... 1-26
 error status..... 2-19
 Error Status variable..... 1-29, 2-21
 ErrorID
 basic instructions..... 3-46, 3-234
 motion control instruction..... 3-498, 3-567
 EtherCAT master errors..... 1-42
 EtherCAT slave errors..... 1-42
 event code..... 1-25
 Event code..... 3-4
 event log..... 1-12
 Event name..... 3-4
 events..... 1-2, 1-12

F

Fatal Errors..... 1-4, 1-9
 Fatal Errors in the CPU Unit..... 2-8
 FH-Series..... A-187
 FQ-M-series..... A-190

G

G5 Series..... A-169
 GEM instructions..... A-14
 GEM Services..... A-12
 Get EtherCAT Error Status..... 1-29, 2-19
 Get EtherNet/IP Error Status..... 1-29, 2-19
 Get I/O Bus Error Status..... 1-29, 2-19
 Get Motion Control Error Status..... 1-29, 2-19
 Get NX Bus Error Status..... 1-29, 2-19
 Get NX Unit Error Status..... 1-29, 2-19
 Get PLC Controller Error Status..... 1-29, 2-19

- Get X Bus Error Status..... 1-29, 2-19
 Get X Bus Unit Error Status..... 1-29, 2-19
 GetCJBError (Get I/O Bus Error Status)..... 1-29, 2-19
 GetECError (Get EtherCAT Error Status)..... 1-29, 2-19
 GetEIPError (Get EtherNet/IP Error Status)..... 1-29, 2-19
 GetMCEError (Get Motion Control Error Status)..... 1-29, 2-19
 GetNXBError (Get NX Bus Error Status)..... 1-29, 2-19
 GetNXUnitError (Get NX Unit Error Status)..... 1-29, 2-19
 GetPLCError (Get PLC Controller Error Status)..... 1-29, 2-19
 GetXBError (Get X Bus Error Status)..... 1-29, 2-19
 GetXBUnitError (Get X Bus Unit Error Status)..... 1-29, 2-19
 GX-series..... A-147
- ## H
- Hardware Initialization Error..... 2-9
 HMI..... A-300
- ## I
- identifying and resetting errors..... 2-10
 Incorrect Power Supply Unit Connected..... 1-9, 2-9
 indicators..... 1-5, 1-27
 Information level..... 1-17
 instructions reading function module error status..... 1-29
- ## L
- Level..... 3-4
 levels..... 1-17
 Log category..... 3-4
- ## M
- major fault level..... 1-17, 1-23
 MC Common Errors..... 1-34
 minor fault level..... 1-17
 MX2/RX-series..... A-186
- ## N
- NJ Robotics..... A-38
 Non-fatal Errors..... 1-4
 Non-fatal Errors in the CPU Unit..... 1-12, 2-10
 NX-AD□□□□..... A-89
 NX-CIF□□□..... A-107
 NX-CT□□□□..... A-143
 NX-DA□□□□..... A-89
 NX-EC0□□□..... A-103
 NX-ECC□□□..... A-80
 NX-ECS□□□..... A-103
 NX-EIP201..... A-137
 NX-HB□□□□..... A-89
 NX-ID□□□□..... A-86
 NX-ILM□□□..... A-128
 NX-OC□□□□..... A-86
 NX-OD□□□□..... A-86
 NX-PC0□□□..... A-102
 NX-PD1□□□..... A-102
 NX-PF0□□□..... A-102
 NX-PG0□□□..... A-103
 NX-RS□□□□..... A-124
 NX-series Analog EtherNet/IP Unit..... A-137
 NX-series Analog I/O Units..... A-89
 NX-series Digital I/O Units..... A-86
 NX-series EtherCAT Coupler Unit..... A-80
 NX-series High-speed Counte Units..... A-143
 NX-series IO-Link Master Units..... A-128
 NX-series Load Cell Input Units..... A-124
 NX-series Position Interface Units..... A-103, A-107
 NX-series Safety Control Unit..... A-110, A-120
 NX-series Safety CPU Unit..... A-110
 NX-series Safety I/O Unit..... A-120
 NX-series System Units..... A-102
 NX-series Temperature Control Units..... A-132
 NX-SI□□□□..... A-120
 NX-SL3□□□..... A-110
 NX-SL5□□□..... A-110
 NX-SO□□□□..... A-120
 NX-TBX01..... A-102
 NX-TC□□□□..... A-132
 NX-TS□□□□..... A-89
- ## O
- Observation level..... 1-17
 Online..... 2-24
 Online connection..... 2-37
 OPC UA Instructions..... 3-827, 3-851
 OPC UA Server..... 3-828
 OPC UA Server Function..... 3-818
 Other Troubles and Corrections..... 3-737
- ## P
- partial fault level..... 1-17
 Power Supply Error..... 1-9, 2-8
 Prevention..... 3-4
 project unit version..... 3-3, A-303
- ## R
- Recovery..... 3-4
 Reset EtherCAT Error..... 2-20
 Reset I/O Bus Controller Error..... 2-20
 Reset Motion Control Error..... 2-20
 Reset NX Bus Error..... 2-20
 Reset PLC Controller Error..... 2-20
 Reset X Bus Unit Error..... 2-20
 ResetCJBError (Reset I/O Bus Controller Error)..... 2-20
 ResetECError (Reset EtherCAT Error)..... 2-20
 ResetMCEError (Reset Motion Control Error)..... 2-20
 ResetNXBError (Reset NX Bus Error)..... 2-20
 ResetPLCError (Reset PLC Controller Error)..... 2-20
 resetting errors..... 1-31, 2-16, 2-19
 Resetting errors..... 2-20
 ResetXBUnitError (Reset X Bus Unit Error)..... 2-20
 Restore function..... 3-747
 robot control..... A-18
 robot control instructions..... A-29

robot instruction.....A-50

S

security errors..... 3-430
source details..... 1-15
Source details..... 3-4
sources..... 1-34, 1-38, 1-42
Starting the Safe Mode..... 2-35
Support software cannot go online..... 2-24
System Initialization Error..... 1-10, 2-8
system-defined variables..... 1-29, 2-21

T

TCP application errors..... 1-38
Troubleshooter..... 1-28, 2-16, A-300
troubleshooting..... 1-28
Troubleshooting Functions..... 2-10

U

User-defined events..... 1-12

V

version..... 18

Z

ZW-CE1.....A-193

OMRON Corporation Industrial Automation Company

Kyoto, JAPAN

Contact : www.ia.omron.com

Regional Headquarters

OMRON EUROPE B.V.

Wegalaan 67-69, 2132 JD Hoofddorp
The Netherlands
Tel: (31) 2356-81-300 Fax: (31) 2356-81-388

OMRON ASIA PACIFIC PTE. LTD.

438B Alexandra Road, #08-01/02 Alexandra
Technopark, Singapore 119968
Tel: (65) 6835-3011 Fax: (65) 6835-3011

OMRON ELECTRONICS LLC

2895 Greenspoint Parkway, Suite 200
Hoffman Estates, IL 60169 U.S.A.
Tel: (1) 847-843-7900 Fax: (1) 847-843-7787

OMRON (CHINA) CO., LTD.

Room 2211, Bank of China Tower,
200 Yin Cheng Zhong Road,
PuDong New Area, Shanghai, 200120, China
Tel: (86) 21-6023-0333 Fax: (86) 21-5037-2388

Authorized Distributor:

©OMRON Corporation 2011-2026 All Rights Reserved.
In the interest of product improvement,
specifications are subject to change without notice.

Cat. No. W503-E1-48 0426