

# OMRON

## Smart Sensor

2D CMOS Laser Type

### ZS-HL Series

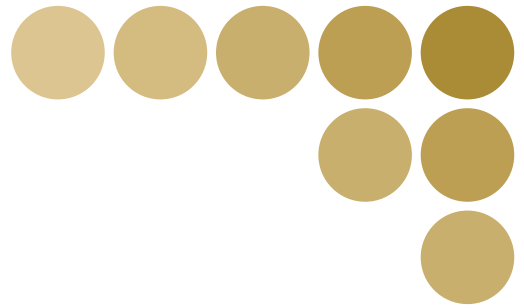

## User's Manual



Cat. No. Z236-E1-08

# Introduction

This manual provides information regarding functions, performance and operating methods that are required for using the ZS-HL Series.

When using the ZS-HL Smart Sensor, be sure to observe the following:

- The ZS-HL Smart Sensor must be operated by personnel knowledgeable in electrical engineering.
- To ensure correct use, please read this manual thoroughly to deepen your understanding of the product.
- Please keep this manual in a safe place so that it can be referred to whenever necessary.

## ■ How to Switch the Display Language to English

Turn the power ON with the MENU key held down. This displays the display language selection screen.



The Controller will start up with the messages displayed in English when it is next started up.

<b>INTRODUCTION</b>	Terms and Conditions Agreement(Please Read)	<b>Introduction</b>
<b>SECTION 1</b>	<b>FEATURES</b>	<b>Section 1</b>
<b>SECTION 2</b>	<b>INSTALLATION &amp; CONNECTION</b>	<b>Section 2</b>
<b>SECTION 3</b>	<b>APPLICATION and SETTING EXAMPLES</b>	<b>Section 3</b>
<b>SECTION 4</b>	<b>FUNCTIONS AND OPERATIONS USED DURING OPERATION</b>	<b>Section 4</b>
<b>SECTION 5</b>	<b>SETTINGS FOR FUNCTIONS</b>	<b>Section 5</b>
<b>SECTION 6</b>	<b>I/O</b>	<b>Section 6</b>
<b>SECTION 7</b>	<b>USB/RS-232C COMMUNICATION</b>	<b>Section 7</b>
<b>SECTION 8</b>	<b>SPECIFICATIONS AND EXTERNAL DIMENSIONS</b>	<b>Section 8</b>
<b>SECTION 9</b>	<b>APPENDIX</b>	<b>Section 9</b>

# User's Manual

Smart Sensor  
2D CMOS Laser Type  
ZS-HL Series

## Terms and Conditions Agreement

---

### Warranty, Limitations of Liability

#### Warranties

- **Exclusive Warrant**

Omron's exclusive warranty is that the Products will be free from defects in materials and workmanship for a period of twelve months from the date of sale by Omron (or such other period expressed in writing by Omron). Omron disclaims all other warranties, express or implied.

- **Limitations**

OMRON MAKES NO WARRANTY OR REPRESENTATION, EXPRESS OR IMPLIED, ABOUT NON-INFRINGEMENT, MERCHANTABILITY OR FITNESS FOR A PARTICULAR PURPOSE OF THE PRODUCTS. BUYER ACKNOWLEDGES THAT IT ALONE HAS DETERMINED THAT THE PRODUCTS WILL SUITABLY MEET THE REQUIREMENTS OF THEIR INTENDED USE.

Omron further disclaims all warranties and responsibility of any type for claims or expenses based on infringement by the Products or otherwise of any intellectual property right.

- **Buyer Remedy**

OMRON MAKES NO WARRANTY OR REPRESENTATION, EXPRESS OR IMPLIED, ABOUT Omron's sole obligation hereunder shall be, at Omron's election, to (i) replace (in the form originally shipped with Buyer responsible for labor charges for removal or replacement thereof) the non-complying Product, (ii) repair the non-complying Product, or (iii) repay or credit Buyer an amount equal to the purchase price of the non-complying Product; provided that in no event shall Omron be responsible for warranty, repair, indemnity or any other claims or expenses regarding the Products unless Omron's analysis confirms that the Products were properly handled, stored, installed and maintained and not subject to contamination, abuse, misuse or inappropriate modification. Return of any Products by Buyer must be approved in writing by Omron before shipment. Omron Companies shall not be liable for the suitability or unsuitability or the results from the use of Products in combination with any electrical or electronic components, circuits, system assemblies or any other materials or substances or environments. Any advice, recommendations or information given orally or in writing, are not to be construed as an amendment or addition to the above warranty.

Omron further disclaims all warranties and responsibility of any type for claims or expenses based on infringement by the Products or otherwise of any intellectual property right.

See <http://www.omron.com/global/>

or contact your Omron representative for published information.LIMITATIONS OF LIABILITY

#### **Limitation on Liability; Etc**

OMRON COMPANIES SHALL NOT BE LIABLE FOR SPECIAL, INDIRECT, INCIDENTAL, OR CONSEQUENTIAL DAMAGES, LOSS OF PROFITS OR PRODUCTION OR COMMERCIAL LOSS IN ANY WAY CONNECTED WITH THE PRODUCTS, WHETHER SUCH CLAIM IS BASED IN CONTRACT, WARRANTY, NEGLIGENCE OR STRICT LIABILITY.

Further, in no event shall liability of Omron Companies exceed the individual price of the Product on which liability is asserted.

## **Application Considerations**

### **Suitability of Use**

Omron Companies shall not be responsible for conformity with any standards, codes or regulations which apply to the combination of the Product in the Buyer's application or use of the Product. At Buyer's request, Omron will provide applicable third party certification documents identifying ratings and limitations of use which apply to the Product. This information by itself is not sufficient for a complete determination of the suitability of the Product in combination with the end product, machine, system, or other application or use. Buyer shall be solely responsible for determining appropriateness of the particular Product with respect to Buyer's application, product or system. Buyer shall take application responsibility in all cases.

NEVER USE THE PRODUCT FOR AN APPLICATION INVOLVING SERIOUS RISK TO LIFE OR PROPERTY OR IN LARGE QUANTITIES WITHOUT ENSURING THAT THE SYSTEM AS A WHOLE HAS BEEN DESIGNED TO ADDRESS THE RISKS, AND THAT THE OMRON PRODUCT(S) IS PROPERLY RATED AND INSTALLED FOR THE INTENDED USE WITHIN THE OVERALL EQUIPMENT OR SYSTEM.

### **Programmable Products**

Omron Companies shall not be responsible for the user's programming of a programmable Product, or any consequence thereof.

## **Disclaimers**

### **Performance Data**

Data presented in Omron Company websites, catalogs and other materials is provided as a guide for the user in determining suitability and does not constitute a warranty. It may represent the result of Omron's test conditions, and the user must correlate it to actual application requirements. Actual performance is subject to the Omron's Warranty and Limitations of Liability.

### **Change in Specifications**

Product specifications and accessories may be changed at any time based on improvements and other reasons. It is our practice to change part numbers when published ratings or features are changed, or when significant construction changes are made. However, some specifications of the Product may be changed without any notice. When in doubt, special part numbers may be assigned to fix or establish key specifications for your application. Please consult with your Omron's representative at any time to confirm actual specifications of purchased Product.

### **Errors and Omissions**

Information presented by Omron Companies has been checked and is believed to be accurate; however, no responsibility is assumed for clerical, typographical or proofreading errors or omissions.

## Meanings of Signal Words

The following signal words are used in this manual.



Indicates a potentially hazardous situation which, if not avoided, will result in minor or moderate injury, or may result in serious injury or death. Additionally there may be significant property damage.

## Meanings of Alert Symbols

The following alert symbols are used in this manual.

	Indicates general prohibitions for which there is no specific symbol.
	Indicates the possibility of laser radiation.
	Indicates prohibition when there is a risk of minor injury from electrical shock or other source if the product is disassembled.

## Alert statements in this Manual

The following alert statements apply to the products in this manual. Each alert statement also appears at the locations needed in this manual to attract your attention.

This product is not designed or rated for ensuring safety of persons. Do not use it for such purposes.	
Never look into the laser beam. Doing so continuously will result in visual impairment.	
Do not disassemble the product. Doing so may cause the laser beam to leak, resulting in the danger of visual impairment.	

## Precautions for Safe Use

Please observe the following precautions for safe use of the products.

### (1) Installation Environment

- Do not use the product in environments where it can be exposed to inflammable/explosive gas.
- To secure the safety of operation and maintenance, do not install the product close to high-voltage devices and power devices.

### (2) Power Supply and Wiring

- The supply voltage must be within the rated range (DC24 V  $\pm$  10 %).
- Reverse connection of the power supply is not allowed.
- Open-collector outputs should not be short-circuited.
- Use the power supply within the rated load.
- High-voltage lines and power lines must be wired separately from this product. Wiring them together or placing them in the same duct may cause induction, resulting in malfunction or damage.

### (3) Regulations and Standards

- EN61326-1
- Electromagnetic environment : Industrial electromagnetic environment (EN/IEC 61326-1 Table 2)
- The following condition is applied to the immunity test of this product: There may be cases that current or voltage output fluctuate within  $\pm 3\%$ F.S. when a sensor is experienced electromagnetic interference.

#### • Notice for Korea Radio Law

A 급 기기 (업무용 방송통신기자재)  
이 기기는 업무용 ( A 급 ) 전자파적합기기로서 판매자  
또는 사용자는 이 점을 주의하시기 바라며 , 가정외의  
지역에서 사용하는 것을 목적으로 합니다.

### (4) Others

- Do not attempt to dismantle, repair, or modify the product.
- Dispose of this product as industrial waste.

## Precautions for Correct Use

Please observe the following precautions to prevent failure to operate, malfunctions, or undesirable effects on product performance.

### (1) Installation Site

Do not install the product in locations subjected to the following conditions:

- Ambient temperature outside the rating
- Rapid temperature fluctuations (causing condensation)
- Relative humidity outside the range of 35 to 85 %
- Presence of corrosive or flammable gases
- Presence of dust, salt, or iron particles
- Direct vibration or shock
- Reflection of intense light (such as other laser beams or electric arc-welding machines)
- Direct sunlight or near heaters
- Water, oil, or chemical fumes or spray
- Strong magnetic or electric field

### (2) Power Supply and Wiring

- When using a commercially available switching regulator, make sure that the FG terminal is grounded.
- If surge currents are present in the power lines, connect surge absorbers that suit the operating environment.
- Before turning ON the power after the product is connected, make sure that the power supply voltage is correct, there are no incorrect connections (e.g. load short-circuit) and the load current is appropriate. Incorrect wiring may result in breakdown of the product.
- Before connecting/disconnecting the Sensor Head, make sure that the Smart Sensor is turned OFF. The Smart Sensor may break down if the Sensor Head is connected or disconnected while the power is ON.
- Use the Extension Cable (provided) for extending the cable between the Sensor Head and Sensor Controller. The total length varies according to the type of Extension Cable.
  - Extension Cable: ZS-XC\_A: within 10 m (including Sensor Head cable. Extension Cable cannot be daisy-chained.)
  - Extension Cable: ZS-XC\_B(R): within 22 m (including Sensor Head. Up to two Extension Cables can be daisy-chained.)
  - Extension cable for a long distance ZS-XC\_\_CR: within 27 m (including Sensor Head. Digital equalizer ZS-XEQ and the Digital equalizer connection cable ZS-XC02D are necessary. The extension cable cannot be daisy-chained.)
- The cable may break at locations when it is made to bend. So, use the robot cable type Extension Cable (ZS-XC5BR, ZS-XC\_\_CR).
- Use only combinations of Sensor Heads and Sensor Controllers specified in this manual.



### (3) Orientation when Installing the Sensor Controller

To improve heat radiation, install the Sensor Controller only in the orientation shown below.

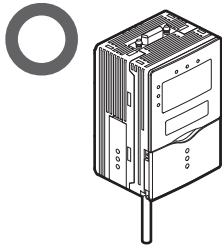

Do not install the Sensor Controller in the following orientations.

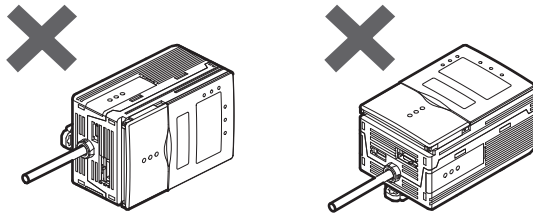

### (4) Warming Up

After turning ON the power supply, allow the product to stand for at least 30 minutes before use. The circuits are still unstable immediately after the power supply is turned ON, so measured values may fluctuate gradually.

### (5) Maintenance and Inspection

Do not use thinner, benzene, acetone or kerosene to clean the Sensor Head and Sensor Controller. If large dust particles adhere to the front filter of the Sensor Head, use a blower brush (used to clean camera lenses) to blow them off. Do not blow the dust particles with your mouth. To remove smaller dust particles, wipe gently with a soft cloth (for cleaning lenses) moistened with a small amount of alcohol. Do not use excessive force to wipe off dust particles. Scratches on the filter may cause errors.

### (6) Sensing Objects

The product sometimes cannot accurately measure the following types of objects: Transparent objects, objects with an extremely low reflection factor, objects smaller than the spot diameter, objects with a large curvature, excessively inclined objects, etc.

### (7) Effect caused by peripheral lights

Do not install the Sensor Head in a place where strong light hits the laser emitter/receiver section of the Sensor Head. Also, if a workpiece has a shiny surface, the light from the lighting will be reflected and a malfunction may occur. In such a case, prevent reflection by, for example, covering the light to stop reflection.

 p.2-4

# Editor's Note

## Page Format

The diagram illustrates the layout of a page titled "Setting the Filter Function" from the ZS-HL User's Manual. The page is annotated with dashed lines and labels to explain its format:

- Title of each section:** Points to the top header "Section5 Setting the Filter Function".
- Header:** Points to the main section title "Setting the Filter Function".
- Overview:** Points to the introductory text "Set the conditions for filtering information obtained from the sensor.".
- Cross-header:** Points to the sub-section title "Setting SMOOTH".
- Overview of the cross-header:** Points to the descriptive text for the SMOOTH function.
- Index label:** Points to the vertical label "Section5 SETTINGS FOR FUNCTIONS" on the right side of the page.
- Movement through menus up to setting items:** Points to the navigation path "FUN Mode-[FILTER]-[SMOOTH]" and the "Setting" table.
- Explanation of options:** Points to the "Description" column of the "Setting" table.

The page content includes:

- Section 5: Setting the Filter Function**
- Setting the Filter Function**
- Set the conditions for filtering information obtained from the sensor.
- Waveform when filter function is not set (Displacement vs. Smooth)
- SMOOTH** (Spike-like changes are removed)
- Average value (Changes are smoothed out)
- Differentiation (Changes are extracted to eliminate displacement value)
- Setting SMOOTH**
- The intermediate value of multiple sets of data can be output as the measurement result. This function removes any abnormal values such as spiking that occur when the shape of the workpiece suddenly changes during measurement.
- Example: To remove spiking
- Abnormal values such as spiking that occur when the shape of the workpiece suddenly changes during measurement.
- The smoothing function can remove spikes
- FUN Mode-[FILTER]-[SMOOTH]

Setting	Description
OFF	The smooth function is not used.
ON	The intermediate value of the past 15 measured values is set as the measurement result at each sampling cycle (default value)

- When "HI-SPEED" is set in the measurement mode, [OFF] is set.
- Lightbulb icon: CHECK!
- ZS-HL User's Manual 5-11

### Supplementary Explanation

Helpful information regarding operation and reference pages are introduced here using symbols.



\*This page has been made purely for explanatory purposes and does not exist.

## ■ Meaning of Symbols

Menu items that are displayed on the Sensor Controller's LCD screen, and windows, dialog boxes and other GUI elements displayed on the PC are indicated enclosed by brackets [ ].

## ■ Vidual Aids



Indicates points that are important to ensure full product performance, such as operational precautions and application procedures.

CHECK!



Indicates pages where related information can be found.



Indicates information helpful in operation.

MEMO

# CONTENTS

Terms and Conditions Agreement	2
Meanings of Signal Words	4
Meanings of Alert Symbols	4
Alert statements in this Manual	4
Precautions for Safe Use	5
Precautions for Correct Use	6
Editor's Note	8
Page Format	8
CONTENTS	11
Search from Menu Tree	16
<b>Section 1 FEATURES</b>	<b>1-1</b>
Introduction of the ZS-HL Series	1-2
System Configuration	1-3
Part Names and Functions	1-4
Sensor Head	1-4
Sensor Controller	1-5
Operation Modes	1-7
Setting Flow	1-8
<b>Section 2 INSTALLATION &amp; CONNECTION</b>	<b>2-1</b>
About Installation and Connection	2-2
Sensor Head	2-2
Measuring Range	2-3
Basic Precautions for Installation	2-4
Connecting the Sensor Head	2-5
Sensor Controller	2-7
Installation of Sensor Controller	2-7
Wiring the I/O cable	2-10
I/O Circuit Diagrams	2-12
SmartMonitor ZS	2-14
Operating Environment	2-14

Installation/Uninstallation Method	2-15
Starting and Exiting SmartMonitor ZS	2-19
<hr/>	
Section 3 APPLICATION and SETTING EXAMPLES	3-1
<hr/>	
Measuring Height (basic)	3-2
Measuring the Thickness of Transparent Objects	3-4
Measuring the Vertex 2 (peak) in the Line Beam	3-6
Measuring Multiple Items Simultaneously (Multi-Task)	3-8
<hr/>	
Section 4 FUNCTIONS AND OPERATIONS USED DURING OPERATION	4-1
<hr/>	
Switching the Display of the Measured Value	4-2
List of Key Operations in RUN Mode	4-4
Zero Reset Operation	4-5
Threshold Setting	4-7
Bank Switching (change of device setup)	4-10
<hr/>	
Section 5 SETTINGS FOR FUNCTIONS	5-1
<hr/>	
Basic Operations of Sensor Controller	5-2
Displays and Key Operations	5-2
Using the Multi-Task Function	5-4
Switching to Multi-Task Mode	5-5
Selecting Tasks	5-5
Setting for Sensing Conditions	5-6
Setting Measurement Mode	5-6
Setting GAIN	5-7
Setting Head Installation	5-8
Setting the Emitted Light Amount	5-8
Setting Measurement Object	5-9
Setting Mutual Interference Prevention	5-11
Setting the Filter Function	5-12
Setting SMOOTH	5-12
Setting AVERAGE	5-13
Setting Differentiation	5-13
Setting Output Processing of Sensing Information	5-14
Setting the Scaling	5-14
<hr/>	

Setting HOLD Functions	5-18
Setting the Zero Reset Function	5-22
Setting for Measurement of Characteristic Points	5-24
Setting Display Method	5-25
Setting the Digital Display	5-25
Displaying HELP	5-25
Setting the LCD Screen	5-26
Setting the System Environment	5-27
Checking Information	5-27
Setting the Key Lock	5-27
Setting the Sensor Load Method	5-28
Setting the Display Language	5-28
Changing the Way of Obtaining Banks	5-28
Saving the Settings Data	5-29
Clearing the Settings	5-29
Initializing All Settings	5-29
Clearing Banks	5-29
<b>Section 6 I/O</b>	<b>6-1</b>
Overview	6-2
I/O Cable	6-2
Terminal Block Output	6-2
Settings for Linear Output	6-3
Assignment of Linear Output	6-3
Setting Focus	6-4
Correcting Linear Output Values	6-5
Settings for Judgment Output	6-7
Operation Settings at Judgment Output	6-7
Assignment of Judgment Output (For Multi-Task)	6-8
Settings for Terminal Block Output	6-9
Real-Time Parallel Output Unit	6-9
Assignment of Terminal Block Output	6-10
Output Format	6-11
Setting Focus	6-13

Setting the Update Cycle	6-14
Settings for Processing when Measurement Cannot be Performed	6-15
When Connecting ZS-MDC and ZS-DSU	6-16
Settings for Input Signal	6-17
Settings for the Active Direction of an Input Signal	6-17
Changing the Assignment of Input Signals	6-17
Timing Charts	6-18
<b>Section 7 USB/RS-232C COMMUNICATION</b>	<b>7-1</b>
Overview	7-2
USB	7-2
RS-232C	7-3
Connecting Using a USB Cable	7-4
Connection Method	7-4
Setting the Communication Specifications	7-4
Connecting Using a RS-232C Cable	7-5
Connection Method	7-5
Setting the Communication Specifications	7-6
Settings for High-Speed Digital Output	7-7
Timing Charts	7-8
<b>Section 8 SPECIFICATIONS AND EXTERNAL DIMENSIONS</b>	<b>8-1</b>
Sensor Head	8-2
Specifications	8-2
External Dimensions	8-7
Adjusting Mutual Interference	8-14
Spot Diameter	8-18
Usage Width of Line Beam	8-19
Linearity Characteristic by Materials	8-20
Sensor Controller	8-36
Specifications	8-36
External Dimensions	8-38
Accessory	8-39
Panel Mount Adapter	8-39



Extension Cable	8-40
Extension Cable (Long-Distance, Flexible Type)	8-41
RS-232C Cable	8-43
Control Link Unit	8-44
Real-Time Parallel Output Unit	8-45
<hr/>	
Section 9 APPENDIX	9-1
<hr/>	
Troubleshooting	9-2
Error Messages and Countermeasures	9-3
Safety Precautions for Using Laser Equipment	9-4
ZS-HLDS60/ZS-HLDS150	9-4
ZS-LD20/LD20S/LD40/LD50/LD50S/LD80/LD130/LD200/LD350S/HLDS5/ HLDS10	9-6
Requirements from Regulations and Standards	9-7
Summary of Requirements to Manufactures	9-7
Summary of Requirements to User	9-11
Definitions of Laser Classification	9-14
Updating Firmware	9-16
Flow of Updating Firmware	9-16
Index	9-23
Upgrade Information	9-27
Revision History	9-28

# Search from Menu Tree

## ■ FUN Mode

### ● For the Single-Task mode

		*Default Value			
		Settings	Option/Range	Pages	
FUN Mode	SENSING	MODE	STAND, HI-RESO*, HI-SPEED, HI-SENS CUSTOM (EXPOSE, SKIP, LINE)	p.5-6	
		GAIN	1*, 2, 3, 4, 5	p.5-7	
		SETTING	DIFFUSE, REGULAR	p.5-8	
		LASER	AUTO*, RANGE, FIXED (upper limit 0.1 to 80 %)	p.5-8	
		OBJECT	NORMAL*, PCB, MIRROR, GLASS (MODE 1, MODE2), THICK (MODE 1, MODE2)	p.5-9	
		SYNC	OFF*, ON (timing A, timing B)	p.5-11	
	FILTER	SMOOTH	OFF, ON*	p.5-12	
		AVERAGE	1, 2, 4, 8, 16, 32, 64, 128*, 256, 512, 1024, 2048, 4096 (When the mode is set to HIGH- SPEED mode, the value is from 1 to 256.)	p.5-13	
		DIFF	OFF*, ON	p.5-13	
	OUTPUT	SCALING	OFF*, ON (AUTO, MAN)	p.5-14	
		HOLD	TYPE	OFF*, PEAK, BOTTOM, P-P, AVERAGE, SAMPLE	p.5-18
			TRIGGER	EXT*, SELF-UP, SELF-DN	
			DELAY	OFF*, ON (T-DELAY, T-TIME)	
		Zero reset	TYPE	REAL*, HOLD	p.5-22
			OFFSET	-999.999 to 999.999 (default value:0)	
			STATUS	OFF, ON*	

	Settings	Option/Range	Pages	
I/O SET	NO MEAS	KEEP, CLAMP*	p.6-15	
	JUDGE	HYS	0 to 999.999 (default value: 0.05 % of Sensor Head measuring range)	p.6-7
		TIMER	OFF*, OFF-DLY (1 to 5,000 ms), ON-DLY (1 to 5,000 ms), 1SHOT (1 to 5,000 ms)	
	ANALOG	FOCUS	OFF*, ON	p.6-3
		ADJUST	OFF*, ON (-999 to 999)	
		OUT	OFF, ON*	p.6-15
		CLAMP	(for current output) 4' 20 mA (every1 mA), MAX*, MIN (for voltage output) -10 V to 10 V (every1 V), MAX*, MIN	
	TERMINAL	FOCUS	OFF*, ON	p.6-9
		CYCLE	1 to 100 (default value: 1)	
		OUT	NONE*, MEASURE, JUDGE	p.6-15
		CLAMP	0 to 65535 (default value: 65535)	
		DIGITAL	OFF, ON*	p.7-7
		CONNECT	OFF, ON*	p.6-16
	INPUT	ACTIVE	IN0 to IN3 (OFF, ON*)	p.6-17
		MODE	NORMAL*, BANK	
BANK	CHANGE	BANK1*, BANK2, BANK3, BANK4 (if you change the mode to [THRESH], you can select up to BANK32.)	p.4-10	
	MODE	NORMAL*, THRESH	p.5-28	
	CLEAR	(Initializes bank settings.)	p.5-29	
SYSTEM	SAVE	(Saves Sensor Controller settings.)	p.5-29	
	INIT	(Initializes Sensor Controller settings.)	p.5-29	
	INFO	CYCLE	(Displays the current sampling cycle.)	p.5-27
		VERSION	(Displays the Sensor Controller version.)	
	COM (RS-232C)	LENGTH	8 BIT*, 7 BIT	p.7-6
		PARITY	NONE*, ODD, EVEN	
		STOP	1 BIT*, 2 BIT	
		BAUDRAT	9600, 19200, 38400*, 57600, 115200	
		DELIMIT	CR*, LF, CR+LF	
	COM	NODE	0 to 16 (default value: 0)	p.7-6
		KEYLOCK	OFF*, ON	p.5-27
		SenINFO	LOAD*, SAVE	p.5-28
		ZERORST	OFF*, ON	p.5-23
		MUITI	OFF*, ON	p.5-5
	LANGUAG	Japanese*, English	p.5-28	

● For Multi-Task mode

The menu configuration is changed to one in which multiple characteristic points can be measured and output simultaneously (up to four characteristic points).

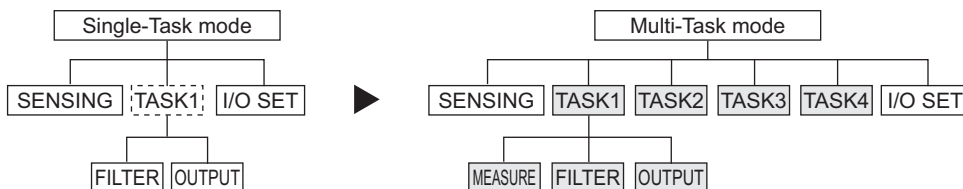

This section describes only the parts that are different from those in Single-Task mode.

		*Default Value				
		Settings	Option/Range (Difference with Single-Task mode)	Pages		
FUN Mode	TASK1	SENSING	MODE	([HIGH SPEED] is not displayed.)	-	
			GAIN	(Same as Single-Task mode)	-	
			SETTING			
			LASER			
			OBJECT	([THICK] is not displayed.)	-	
			SYNC	(Same as Single-Task mode)	-	
		MEASURE	TASKSET	NONE*, AVERAGE, PEAK, BOT-TOM, THICK, STEP, K+mX+nY	p.5-24	
		FILTER	(Same as Single-Task mode)		-	
		OUTPUT	(Same as Single-Task mode)		-	
	TASK2 to 4	MEASURE	TASKSET	NONE*, AVERAGE, PEAK, BOT-TOM, THICK, STEP, K+mX+nY	p.5-24	
			FILTER	(Same as Single-Task mode)		-
			OUTPUT	(Same as Single-Task mode)		-

Settings	Option/Range (Difference with Single-Task mode)	Pages
<pre> graph LR     TASK1[TASK1] --&gt; IOS[I/O SET]     IOS --- Note[Select TASK you want to output.]     IOS --&gt; JUDGE     IOS --&gt; ANALOG     IOS --&gt; TB[TERMINAL BLOCK]     IOS --&gt; DIGITAL     IOS --&gt; CONNECT     IOS --&gt; INPUT             </pre>		
NON-MEAS	(Same as Single-Task mode)	–
JUDGE	HYS	(Same as Single-Task mode)
	TIMER	(Same as Single-Task mode)
	OUT	TASK1*, TASK2, TASK3, TASK4
ANALOG	FOCUS	(Same as Single-Task mode)
	ADJUST	(Same as Single-Task mode)
	OUT	TASK1*, TASK2, TASK3, TASK4, None
	CLAMP LEVEL	(Same as Single-Task mode)
TERMINAL BLOCK	FOCUS	(Same as Single-Task mode)
	CYCLE	(Same as Single-Task mode)
	OUT	NONE*, Measured value (TASK1 to TASK4, REPEAT), JUDGE
	CLAMP	(Same as Single-Task mode)
DIGITAL	TASK1 to TASK4 (OFF, ON)	p.7-7
CONNECT	TASK1*, TASK2, TASK3, TASK4	p.6-16
INPUT	(Same as Single-Task mode)	–

■ **RUN mode**

In RUN mode, you can customize the details that are displayed in the digital displays.  
To call up the display customize menu, press the MENU key in RUN mode.

RUN Mode		Settings	Option/Range	Pages
DIGITAL		DOT	0 to 5th (Item whose default value varies according to the connected Sensor Head)	p.5-25
		ECO	NORMAL*, ECO, OFF	p.5-25
LCD		ON/OFF	ON*, AUTOOFF, OFF	p.5-26
		B.LIGHT	ON*, AUTOOFF, OFF	p.5-26
		CUSTOM	U- ON/OFF, L- ON/OFF U- CUSTM, L- CUSTM (default value: U- OFF, L- OFF)	p.5-26
		HELP	-	p.5-25





■ **TEACH Mode**

This is the mode for setting the threshold values.

TEACH Mode		Settings	Option/Range	Pages
		TEACHING	-	p.4-7
		DIRECT IN	-	

# Section 1

## FEATURES

 Introduction of the ZS-HL Series	1-2
 System Configuration	1-3
 Part Names and Functions	1-4
Sensor Head	1-4
Sensor Controller	1-5
 Operation Modes	1-7
 Setting Flow	1-8

## Introduction of the ZS-HL Series

The ZS-HLDC Series is a 2D COMS laser type displacement sensor. In addition to ZS-L full-digital processing, it maximizes sensing performance using a multi-task function.

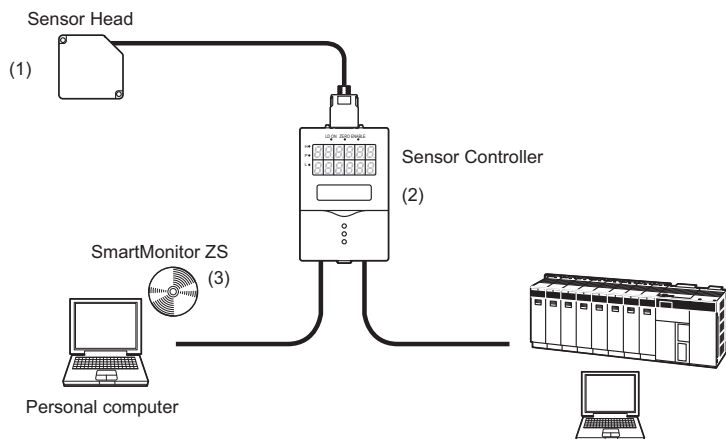

### (1) Enhanced Variation of Sensor Heads

Suitable as a high-end displacement sensor, it supports a wide range of Sensor Heads. You can perform a stable measurement using a Sensor Head that is suitable for the workpiece, from 0.001  $\mu\text{m}$  ultra-high-resolution type to 1500-mm ultra-long-range type.

### (2) Sensor Controller Incorporating Multiple Functions

For one sensing condition, it incorporates a multi-task function that holds up to a maximum of four kinds of measurement processing as a “task.” Because you can measure any characteristic point for each task, you can measure and judge multiple characteristic points simultaneously.

Example: Measure the height and surface fluctuation simultaneously.

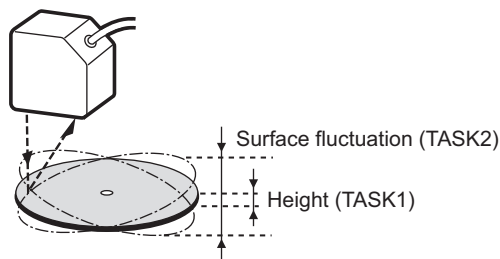

### (3) Setting Support Software for Personal Computer “SmartMonitor ZS”

It displays data and specifies the settings for the controller that is connected via “SmartMonitor ZS” bundled with the Sensor Controller (ZS-HLDC\_1A). You can easily check the sensing status and specify the settings in more detail, which cannot be done using a controller.



If you use “SmartMonitor ZS Professional,” which is sold separately, you can do logging for a measured value.



# System Configuration

In addition to operations with the basic configuration, ZS-HLDC can support various measurement applications when combined with numerous peripheral devices.

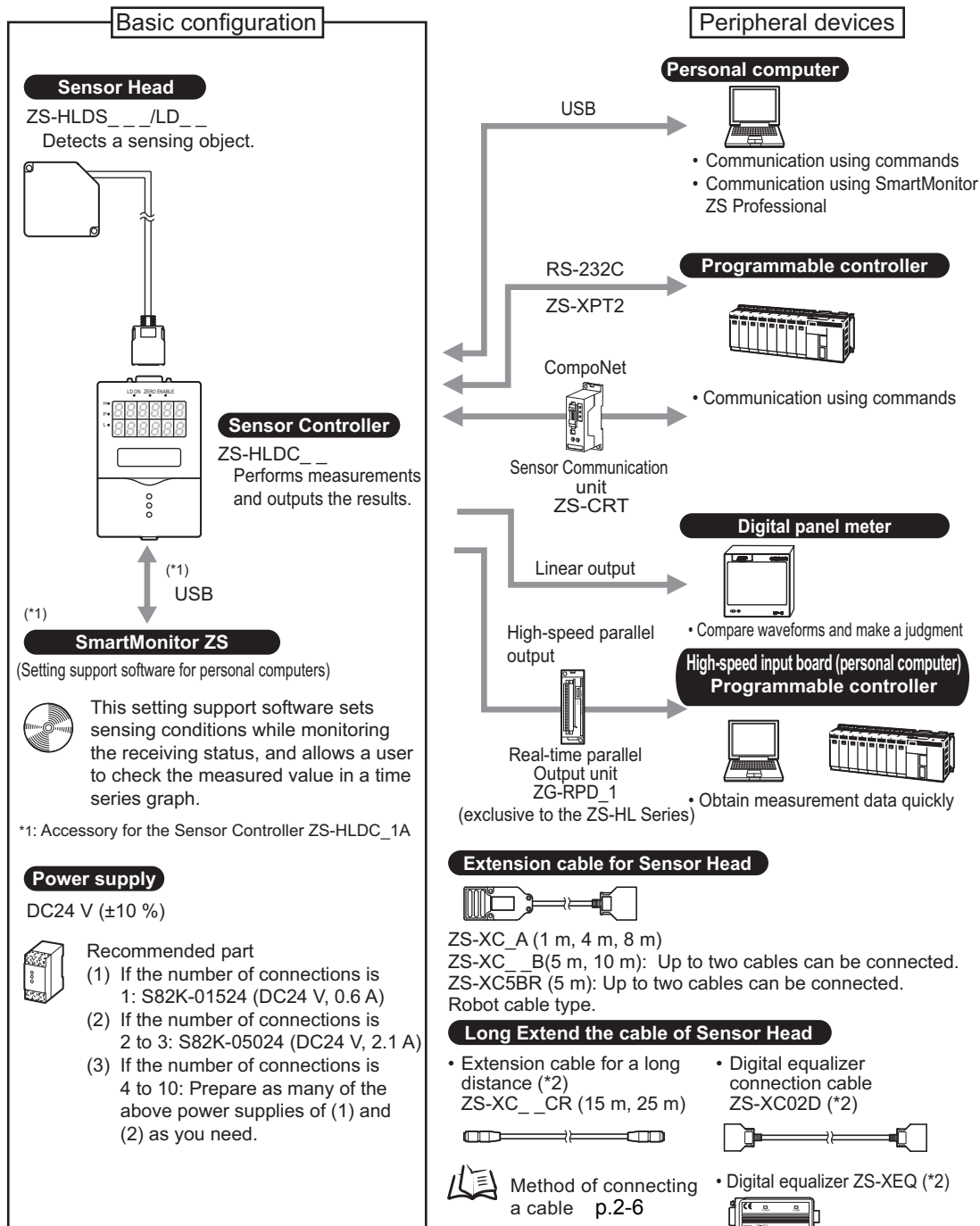

# Part Names and Functions

The following describes the names and functions of parts of the Sensor Head and Sensor Controller.

## Sensor Head

[ZS-HLDS5T/HLDS10]

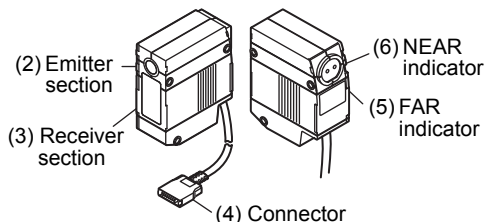

[ZS-LD10GT/LD15GT]

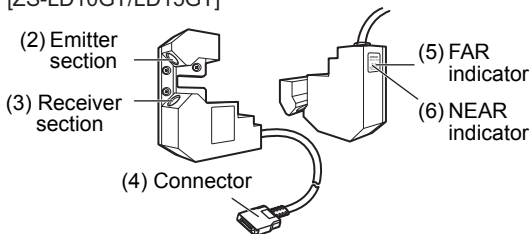

[ZS-HLDS60/HLDS150]

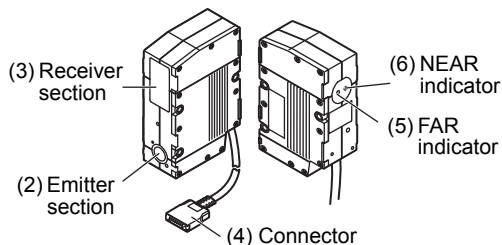

[ZS-LD\_\_\_/HLDS2VT]

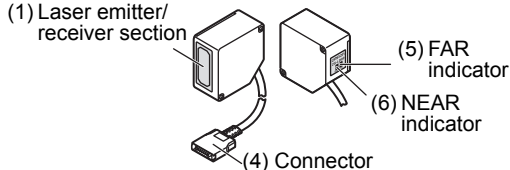



Names	Functions
(1) Laser Emitter/Receiver Section	This is the section that emits the laser beam and receives reflected light.
(2) Emitter section	
(3) Receiver section	
(4) Connector	To be connected to the Sensor Controller
(5) FAR Indicator	These indicators light up as follows according to the distance between the front of the Sensor Head and the workpiece. Both NEAR/FAR indicators are lit up: Measuring center distance $\pm$ (measuring range $\times$ 10 %)  NEAR indicator is lit up: Near side within measuring range FAR indicator is lit up: Far side within measuring range Both NEAR and FAR indicators are flashing: Outside measuring range  These indicators also double as laser alarm indicators. - At least one of the indicators will either light up or flash after the Sensor Head is turned ON. - Both indicators go out for 15 to 25 seconds after the Sensor Head is turned ON to indicate that the laser beam is OFF. - Either of these indicators will light up or flash while the laser beam is being emitted. - Both indicators go off when the laser beam is OFF.
(6) NEAR Indicator	



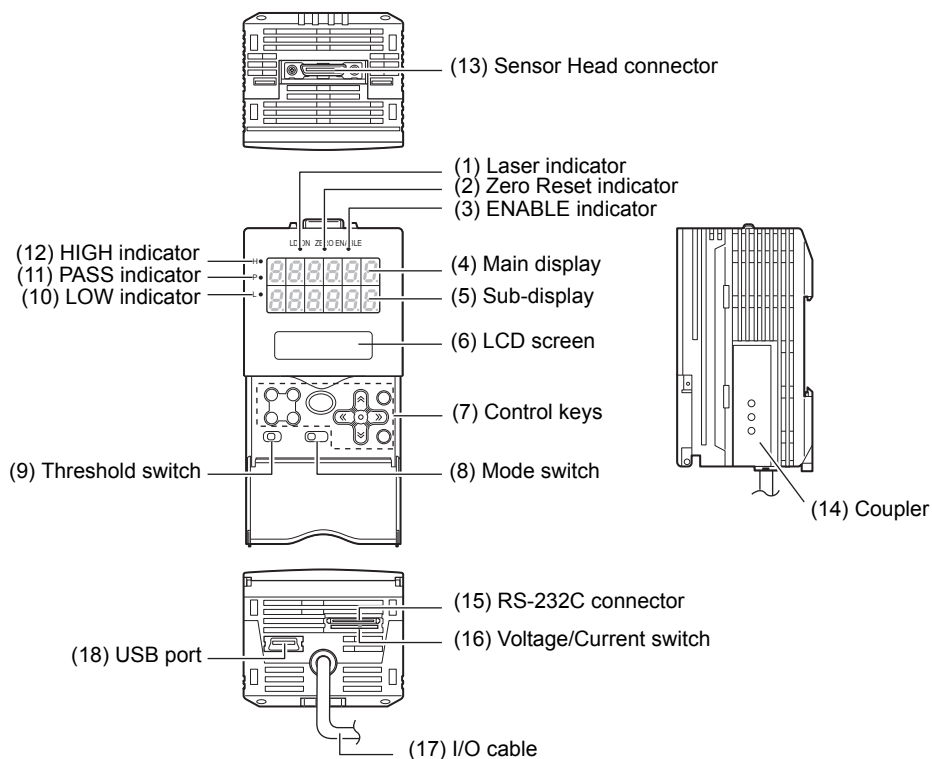

CHECK!

# Sensor Controller



Names	Functions
(1) Laser indicator	The Laser indicator is lit while the Sensor Head is emitting a laser beam.
(2) Zero Reset indicator	The Zero Reset indicator is lit while the zero reset function is enabled.
(3) ENABLE indicator	The ENABLE indicator lights when the Sensor is ready for measurement. It goes off when measurement is not possible (e.g. when the received light amount is excessive or insufficient, when the measuring range is exceeded, or when measurement is not being performed in FUN mode). The ENABLE indicator flashes when a Sensor Head is not connected.
(4) Main Display	The Main Display shows measured values.
(5) Sub-display	The sub-display shows thresholds and additional information during measurement.
(6) LCD screen	RUN mode : Displays additional information for the main display and the setup menu for display related information. TEACH mode: Displays the menu for setting up the thresholds. FUN mode : Displays the measurement condition setup menu.
(7) Control keys	The Control Keys are for setting measurement conditions and other information. The functions assigned to the Control Keys change according to the operating mode.  Key Operations p.4-4, p.5-2
(8) Mode switch	The Mode Switch selects the operating mode. RUN mode : Select this mode when performing regular measurement. TEACH mode: Select this mode when setting the judgment thresholds. FUN mode : Select this mode when setting measurement conditions.

## Section 1 Part Names and Functions

Names	Functions
(9) Threshold switch	The Threshold Selector switch selects whether to set (or display) the HIGH or LOW threshold.
(10) LOW indicator	The LOW indicator is lit while the condition "measured value < LOW threshold" is satisfied.
(11) PASS indicator	The PASS indicator is lit while the condition "LOW threshold ≤ measured value ≤ HIGH threshold" is satisfied.
(12) HIGH indicator	The HIGH indicator is lit while the condition "HIGH threshold < measured value" is satisfied.
(13) Sensor Head connector	This connector connects the Sensor Head.
(14) Coupler	This connector is used to connect two or more Sensor Controllers. It is located on both sides of the Sensor Controller.
(15) RS-232C connector	<p>Connect the RS-232C cable when you are connecting the Sensor Controller to a PLC or a programmable terminal. For the RS-232C cable, please use the following exclusive products: If you use a cable not included in the exclusive products, a malfunction or breakdown may result.</p> <ul style="list-style-type: none"> <li>- For connecting to a PLC or programmable terminal: ZS-XPT2</li> <li>- For connecting to a personal computer: ZS-XRS2</li> </ul> <p>If you connect the Sensor Controller to ZG-RPD and use it, connect a connector for ZG-RPD.</p>
(16) Voltage/Current switch	<p>The Voltage/Current switch selects between voltage output and current output.</p> <div style="display: flex; align-items: flex-start;"> <div style="margin-right: 10px;">   <b>CHECK!</b> </div> <div> <p>Before operating this switch, make sure that the Sensor Controller is turned OFF. Also, make sure that the load connected to "linear output wire (coaxial) - linear GND wire" satisfies the rating of the set state (voltage or current output) before turning the Sensor Controller ON. Otherwise, the Sensor Controller may be damaged.</p> </div> </div> <div style="margin-top: 10px;">  Rating of connected load (I/O Circuit Diagrams) p.2-12         </div>
(17) I/O Cable	The I/O cable connects the Data Storage Unit to the power supply and external devices, such as timing sensors or programmable controllers.
(18) USB port	Connect the USB cable to the USB port to connect to a personal computer.

## Operation Modes

The ZS-HL has the following 3 operating modes. Switch to the desired mode before you start operation.

To switch the operating mode, use the mode switch.

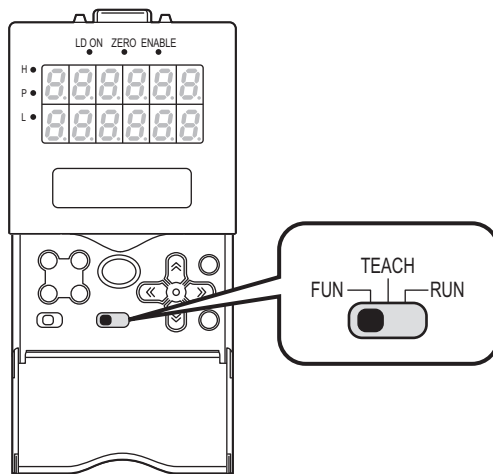

Mode	Description
RUN Mode	Normal operating mode
TEACH Mode	This mode is for setting the judgment threshold values.
FUN Mode	Mode for setting the measurement conditions.



CHECK!

When you switch the operating mode after changing the measurement conditions, you will be prompted to save the settings. Save the settings as required. If you turn off the Sensor Controller without saving these settings, the newly set measurement conditions will be cleared from memory. You can also save all the settings later on.



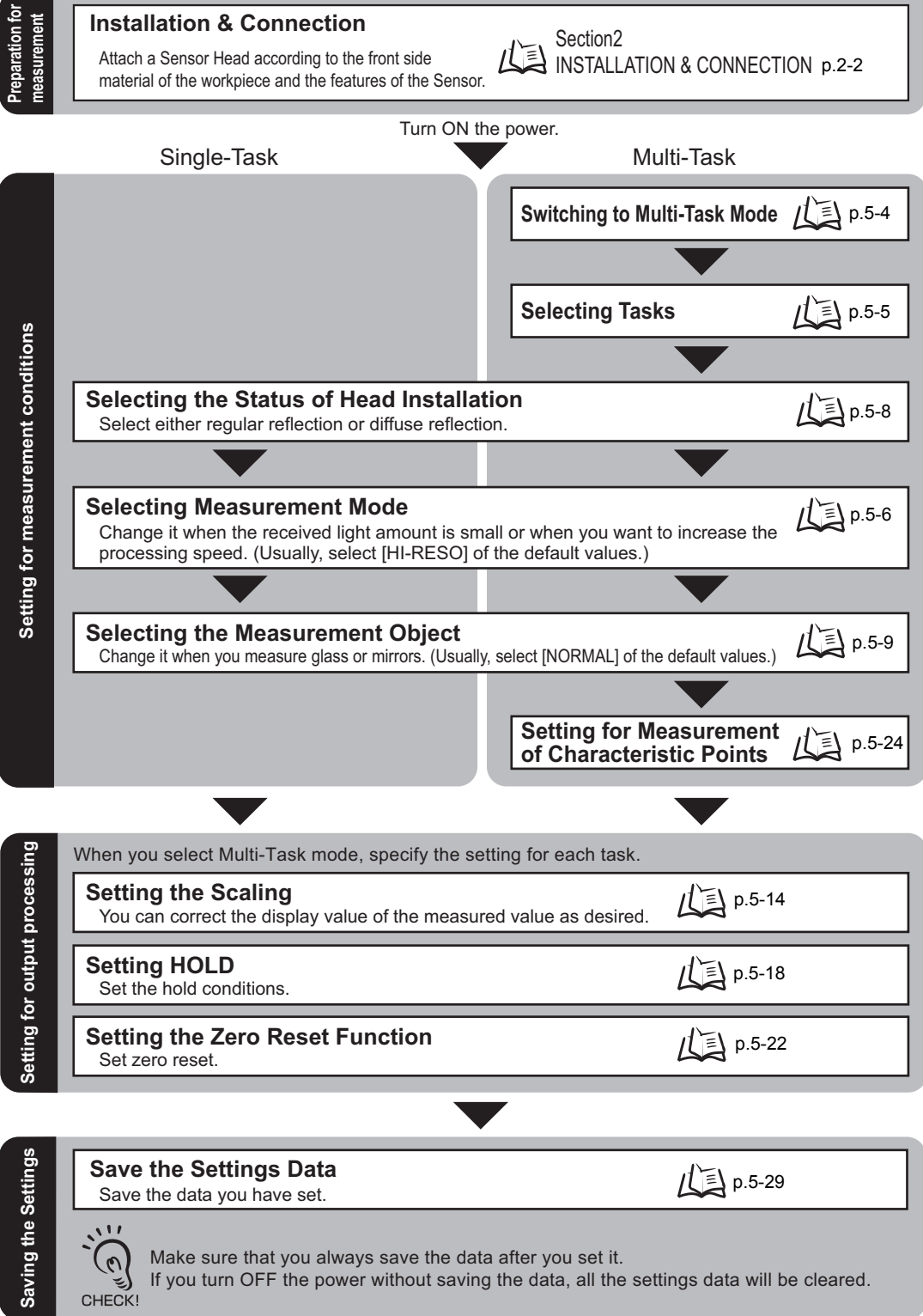

Saving the Settings Data p.5-29

# Setting Flow





Functions Used During  
Operation

Executing Zero Reset	 p.4-6
Threshold Setting	 p.4-7
Bank Switching	 p.4-10





If You Cannot Perform a  
Measurement Smoothly

Adjusting and Setting Sensing Conditions	<ul style="list-style-type: none"> <li>■Setting the Emitted Light Amount p.5-8</li> <li>■Setting Mutual Interference Prevention p.5-11</li> <li>■Setting GAIN p.5-7</li> </ul>	
	Setting the Filter Function	<ul style="list-style-type: none"> <li>■Setting SMOOTH p.5-12</li> <li>■Setting AVERAGE p.5-13</li> <li>■Setting DIFF p.5-13</li> </ul>

Operations and Settings as Required

I/O (JUDGE, LINEAR, and OUTPUT of TERMINAL BLOCK)	 Section6 I/O p.6-2	
USB/RS-232C communication	 Section7 USB/RS-232C COMMUNICATION p.7-2	
Setting Banks	<ul style="list-style-type: none"> <li>■Changing the Way of Obtaining Banks p.5-28</li> <li>■Clearing Banks p.5-29</li> </ul>	
	Setting the Display Method	<ul style="list-style-type: none"> <li>■Setting the Display p.5-25</li> <li>■Setting the LCD display p.5-26</li> <li>■HELP p.5-25</li> </ul>
Setting the System Environment		<ul style="list-style-type: none"> <li>■Initializing Settings Data p.5-29</li> <li>■Checking Information p.5-27</li> <li>■Setting the Communication Specifications p.7-6</li> <li>■Setting Key Lock p.5-27</li> <li>■Setting the Sensor Load Method p.5-28</li> <li>■Setting the Display Language p.5-28</li> </ul>

When a Problem Occurs...

	When The Smart Sensor Does Not Operate Correctly	 Troubleshooting p.9-2
	When An Error Message Appears	 Error Messages and Countermeasures p.9-3

MEMO



# Section2

## INSTALLATION & CONNECTION

☒ About Installation and Connection	2-2
☒ Sensor Head	2-2
Measuring Range	2-3
Basic Precautions for Installation	2-4
Connecting the Sensor Head	2-5
☒ Sensor Controller	2-7
Installation of Sensor Controller	2-7
Wiring the I/O cable	2-10
I/O Circuit Diagrams	2-12
☒ SmartMonitor ZS	2-14
Operating Environment	2-14
Installation/Uninstallation Method	2-15
Starting and Exiting SmartMonitor ZS	2-19

## About Installation and Connection

### ■ Checking the installation environment

Read “Important Points on Safety” at the beginning of this manual, and check the installation environment.

### ■ Checking the installation site

Read “Notes on Use” at the beginning of this manual, and check the installation site.

### ■ About the power supply

Before installing and connecting the Sensor Controller, be sure to turn it OFF. Also read “Important Points on Safety” and “Notes on Use” at the beginning of this manual, and check the power supply and wiring.

## Sensor Head

### WARNING

Never look into the laser beam. Doing so continuously will result in visual impairment.  
Never look into the laser beam.



Do not disassemble the product. Doing so may cause the laser beam to leak, resulting in the danger of visual impairment. Do not disassemble the product.



## Measuring Range

The ZS-HL Series displays - (minus) for the NEAR side and + (plus) for the FAR side with the measuring center distance set to 0 (zero).

Example: For the Sensor Head ZS-HLDS2VT

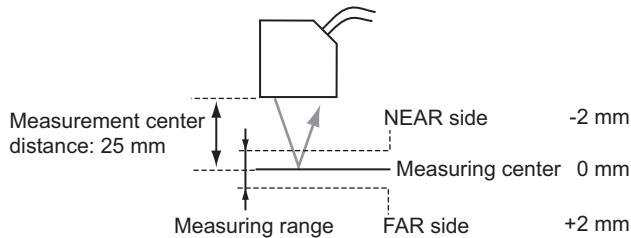

### • ZS-HLDS\_ \_ \_ Series

	Regular reflection		Diffusive reflection	
	Measuring center distance	Measuring range	Measuring center distance	Measuring range
ZS-HLDS2VT	25 mm	±2 mm	–	–
ZS-HLDS5T	44 mm	±4 mm	50 mm	±5 mm
ZS-HLDS10	94 mm	±16 mm	100 mm	±20 mm
ZS-HLDS60	–	–	600 mm	±350 mm
ZS-HLDS150	–	–	1,500 mm	±500 mm

### • ZS-LD\_ \_ \_ Series

	Regular reflection		Diffusive reflection	
	Measuring center distance	Measuring range	Measuring center distance	Measuring range
ZS-LD10GT	10 mm	±0.5 mm	–	–
ZS-LD15GT	15 mm	±0.75 mm	–	–
ZS-LD20T/20ST	20 mm	±1 mm	6.3 mm	±1 mm
ZS-LD40T	40 mm	±2.5 mm	30 mm	±2 mm
ZS-LD50/50S	47 mm	±4 mm	50 mm	±5 mm
ZS-LD80	78 mm	±14 mm	80 mm	±15 mm
ZS-LD130	130 mm	±12 mm	130 mm	±15 mm
ZS-LD200	200 mm	±48 mm	200 mm	±50 mm
ZS-LD350	–	–	350 mm	±135 mm

## Basic Precautions for Installation

### ●Color/shiny surface boundary

Wrong

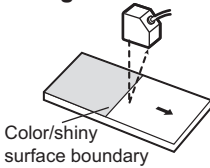

Right

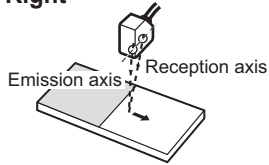

### ●Installing near walls

Measurement errors can be reduced by installing the Sensor Head with the line formed by the emission and reception axes parallel to the wall, and painting the wall with non-reflective black paint.

Wrong

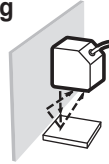

Right

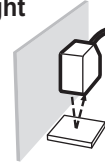

### ●Measuring in narrow grooves

Wrong



Right



### ●Rotating objects

When measuring rotating workpieces, you can minimize the influence caused by vibration of the rotating object and positional shifts by installing the Sensor Head with the line formed by the emission and reception axes parallel to the axis of rotation.

Wrong



Right



### ●Measuring stepped workpieces

Wrong

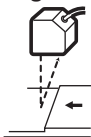

Right

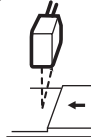

### ●Effect caused by peripheral lights

Do not install the Sensor Head in a place where strong light hits the laser emitter/receiver section of the Sensor Head. Also, if a workpiece has a shiny surface, the light from the lighting will be reflected and a malfunction may occur. In such a case, prevent reflection by, for example, covering the light to stop reflection.

Wrong

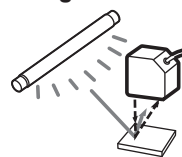

Right

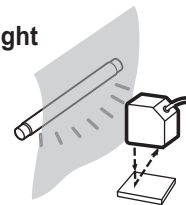

## Connecting the Sensor Head

This connector connects the Sensor Head and controller.



Before connecting/disconnecting the Sensor Head, make sure that the Smart Sensor is turned OFF. The Sensor Controller may break down if it is connected or disconnected while the power is ON.

### ■ Connecting the Sensor Head

Insert the Sensor Head connector into the Sensor Controller until it locks in place.

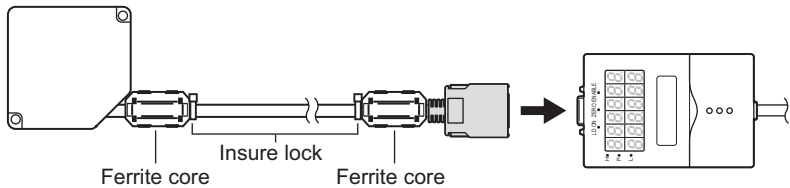

Attach the ferrite core (provided with the Sensor Head) to both ends of the Sensor Head cable in advance.

CHECK!

If the ferrite core comes loose from the cable, fasten the ferrite core in place with the Insure Lock (supplied).

### ■ Disconnecting the Sensor Head

Pull out the Sensor Head while pressing in the hooks on both sides of the Sensor Head connector.

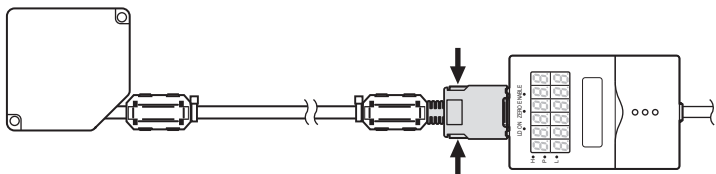

CHECK!

- Do not touch the terminals inside the connector.
- All settings on the Sensor Controller will be cleared if the Sensor Head is replaced with a different type.

## ■ Extension Cable

There are three ways to extend a cable.

- Entire length within 12 m

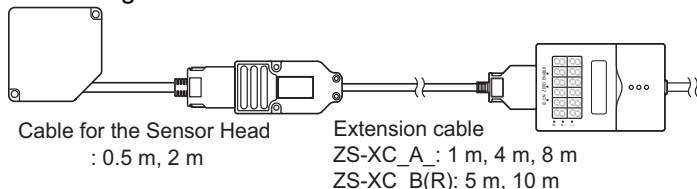

- Entire length within 22 m (Connect extension cables)

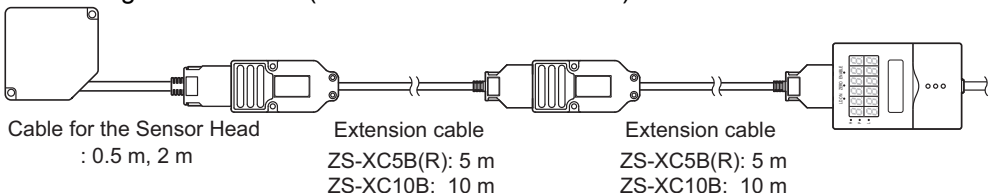

- Extended for a long distance (Use a repeater)

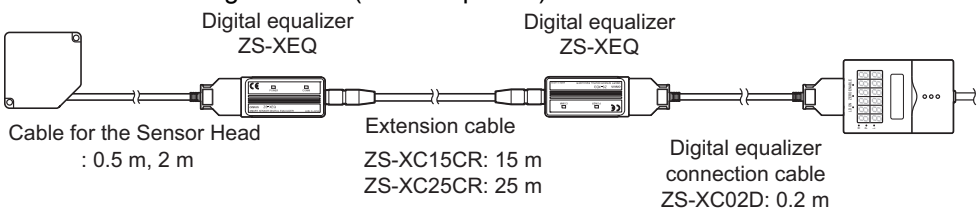

Table for connecting Extension Cable

Extension Cable			Sensor Head		Controller		Precautions
Model	Length	Flexible	ZS-LD_	ZS-HLDS_	ZS-LDC_	ZS-HLDC_	
ZS-XC1A	1m		●	●	●	●	No extended connection allowed
ZS-XC4A	4m		●	●	●	●	No extended connection allowed
ZS-XC8A	8m		●	●	●	●	No extended connection allowed
ZS-XC5B	5m		●	●	●	●	Up to two cables allowed extended connection. (Max22m)
ZS-XC10B	10m		●	●	●	●	Up to two cables allowed extended connection. (Max22m)
ZS-XC5BR	5m	●	●	●	●	●	Up to two cables allowed extended connection. (Max22m)
ZS-XC15CR	15m	●		●		●	Needs ZS-XEQ, ZS-XC02D
ZS-XC25CR	25m	●		●		●	ZS-XEQ, ZS-XC02D



- Only the ZS-XC\_B(R) cable allows this extended connected. Note, however, that the connection with the ZS-XC\_A cannot be extended.
- The cable may break at locations where it is made to bend. So, use a robot cable type extension cable (ZS-XC5BR, ZS-XC\_\_CR).
- Only the Sensor head ZS-HLDS--- can connect to ZS-XC--CR, ZS-XC02D and ZS.
- The Sensor Controller supplies the power of Digital equalizer.

## Sensor Controller

This section describes installation of the Sensor Controller, and connection of the I/O cable.



Before connecting/disconnecting peripheral devices, make sure that the Sensor Controller is turned OFF. The Sensor Controller may break down if it is connected or disconnected while the power is ON.

## Installation of Sensor Controller

### ■ Installing on the DIN track

The following describes how to attach the 35 mm wide DIN track very quickly and easily.

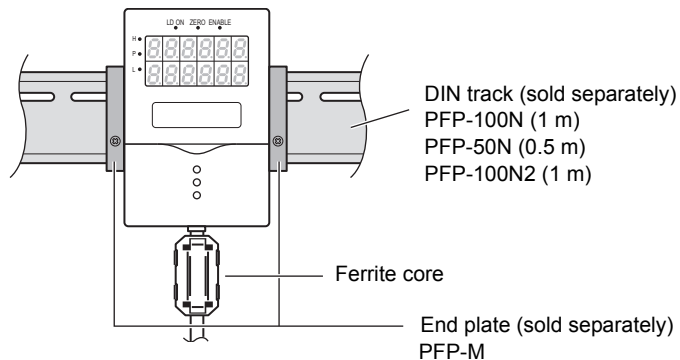

In advance, attach the ferrite core (provided with the Sensor Controller) to the input/output cable of the Sensor Controller.

● Installation procedure

1. Hook the connector end of the Sensor Controller onto the DIN track.

2. Push the Sensor Controller down onto the DIN track until the hook on the I/O cable side is locked.

Push down until you hear it snap into place.

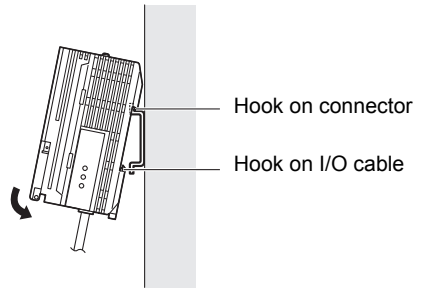

CHECK!

Always hook the connector end of the Sensor Controller on the DIN track first. Hooking the I/O cable end on the DIN track first may impair the mounting strength of the DIN track attachment.

● Removal procedure

1. Pull the hook on the I/O cable end of the Sensor Controller downwards.

2. Lift up the Sensor Controller from the I/O cable end, and remove it from the DIN track.

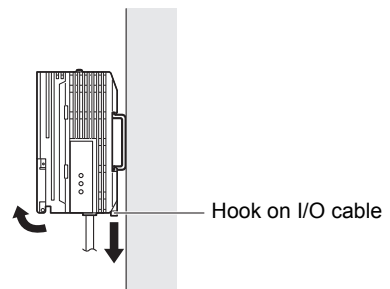

■ Mounting on a panel

The optional Panel Mount Adapters (ZS-XPM1) can be used to mount the Sensor Controller on a panel.



Panel cutout dimensions p.8-39

1. Push out the Sensor Controller from the rear of the panel towards the front.

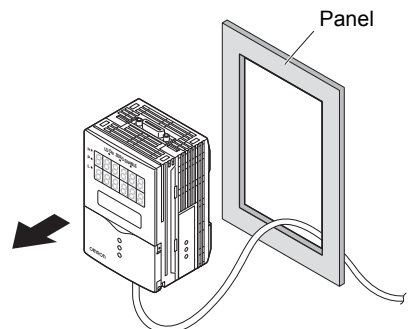



2. Install the small Mount Adapters on the four holes of the Sensor Controller.

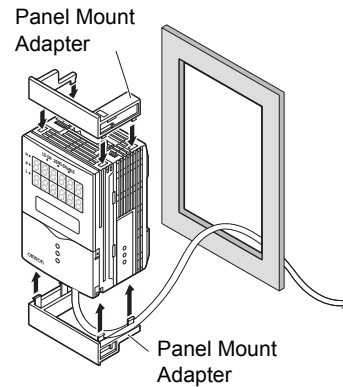

3. Install the long Mount Adapters on the two holes of the small Mount Adapter.

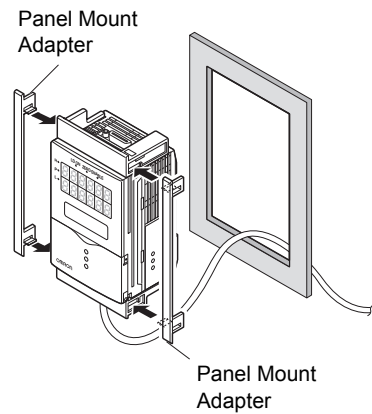

4. Install the Sensor Controller with Panel Mount Adapters attached onto the panel from the front.



Take care not to pinch the I/O cable.

CHECK!

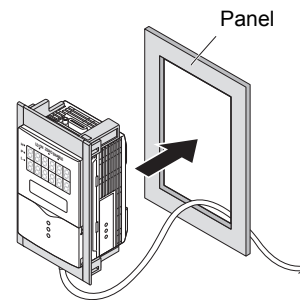

5. Hook the hooks of the mounting fixture onto the two holes of the smaller Mount Adapters and tighten the screws.

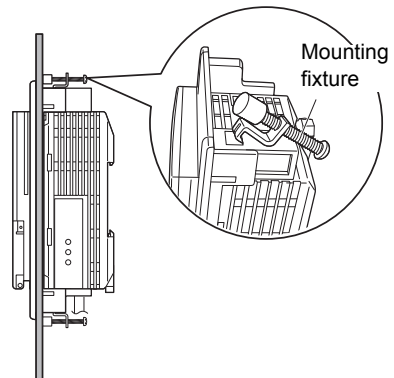

6. Make sure that the Sensor Controller is firmly fixed on the panel.

## Wiring the I/O cable

The following shows the leads that comprise the I/O cable.

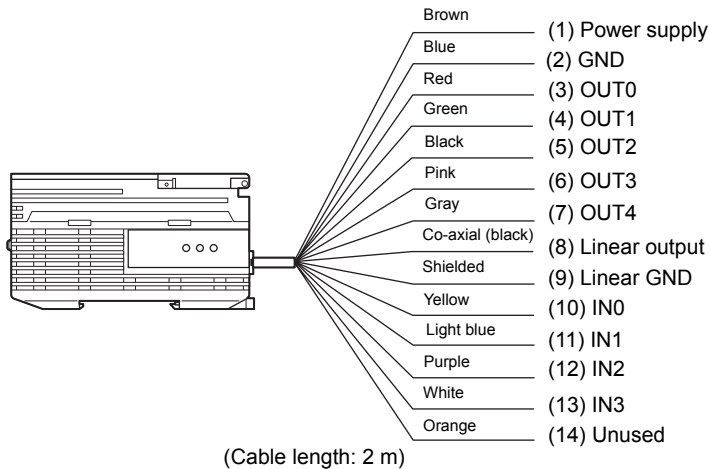

### (1) Power supply

This connects the 24 VDC ( $\pm 10\%$ ) power supply. When using a Sensor Controller with a PNP output, the power supply terminal is also the common I/O terminal for all I/O except for the linear output.

Supply power from a DC power supply unit that has a countermeasure (safety ultra-low voltage circuit) built-in for preventing high voltages from occurring.

 Recommended power supply unit p.1-3

Wire the power supply separately from other devices. Wiring them together or placing them in the same duct may cause induction, resulting in malfunction or damage.

### (2) GND

The GND terminal is the 0 V power supply terminal. When using a Sensor Controller with an NPN output, the GND terminal is also the common I/O terminal for all I/O except for the linear output.

### (3) OUT0 (HIGH output)

This outputs judgment results (HIGH).

### (4) OUT1 (PASS output)

This outputs judgment results (PASS).

### (5) OUT2 (LOW output)

This outputs judgment results (LOW).

### (6) OUT3 (ENABLE output)

This turns ON when the Sensor Controller is ready for measurement. This output is interlocked with the ENABLE indicator.

**(7) OUT4 (BUSY output)**

This turns ON during sampling with the hold function enabled.  
It allows you to check whether or not the self-trigger is functioning correctly.  
It also turns ON during bank switching.

**(8) Linear output**

The linear output outputs a current or voltage in accordance with the measured value.

**(9) Linear GND**

The linear GND terminal is the 0 V terminal for the linear output.



This ground wire must be grounded separately from the blue(0V) ground wire.  
Always ground the linear output terminal even when linear output is not used.

**(10)-(13) IN0 to IN3**

The following input signal assignments can be selected.

• Signal assignments

Signal	When [NORMAL] is selected (default)	When [BANK] is selected
IN0	External trigger (timing) input	Bank input A
IN1	Reset input	Bank input B
IN2	LD-OFF input	LD-OFF input
IN3	Zero reset input	Zero reset input

Setting the I/O assignments p.6-17

• Signal functions

Signal name	Description
External trigger (timing) input	This timing input is for signal input from external devices. Use it for hold function timing.
Reset input	This resets all executing measurements and outputs. While a reset is being input, judgment output conforms to the non-measurement setting. If this reset input switches ON while the hold function is used, the state in effect before the hold function was set will be restored. Status indicators p.8-37
LD-OFF input	If this LD-OFF signal is set to ON, the laser will stop emission, causing a light amount error. While LD-OFF is being input, judgment output conforms to the non-measurement setting.
Zero reset input	This is used to execute and clear a zero reset.
Bank input A, B	This is used for switching banks. Specify the bank No. in combinations of A and B. However, if the bank mode is set to [THRESH], the bank cannot be switched at the external signal input because the number of banks increases to 32.

External I/O timing chart p.6-18

# I/O Circuit Diagrams

- NPN type (ZS-HLDC11)

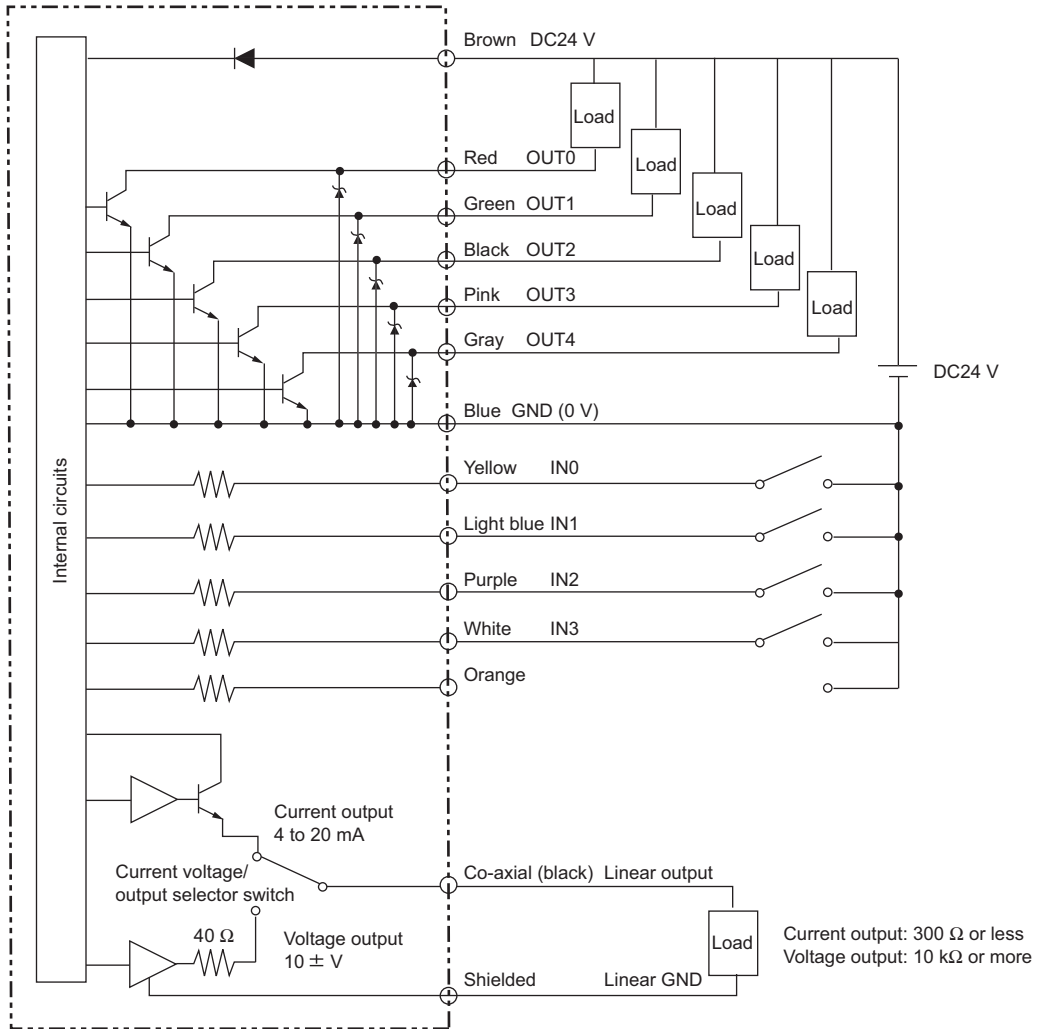

● PNP type (ZS-HLDC41)

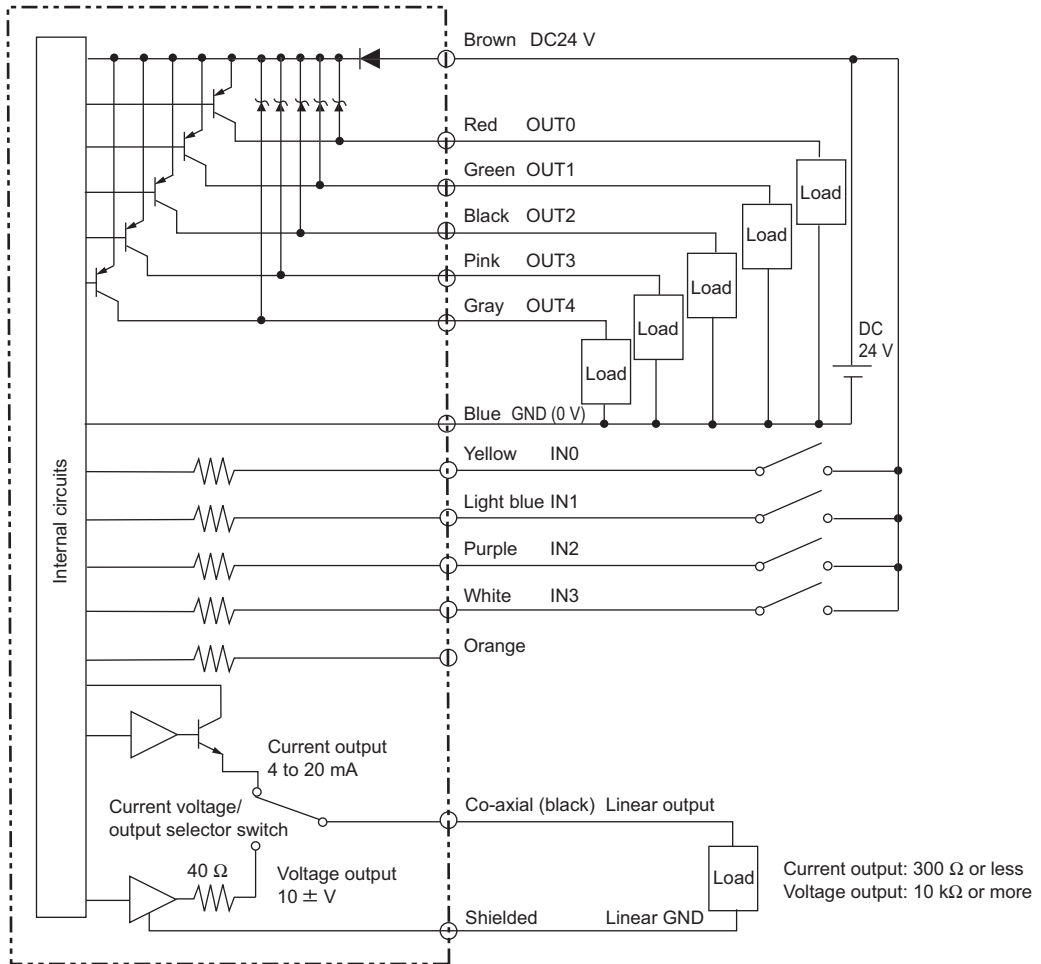

# SmartMonitor ZS

ZS-HL is provided with the SmartMonitor ZS software utility. This utility allows you to set up sensing functions and monitor the waveforms of measurement results on a personal computer.

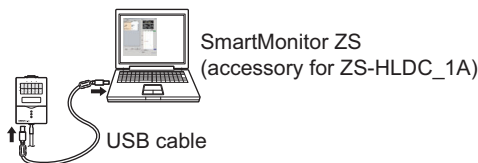

## ● Monitoring the measurement state

Checks the measured value of the gang-mounted controller in the list.

Displays the change of the time series for the measured value in a graph.

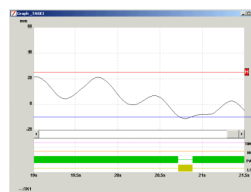
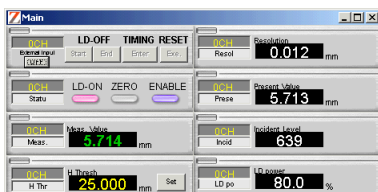

## ● Setting support for functions

Sets the sensing conditions in detail while checking the receiving status of the Sensor Head (sensitivity).

Displays and sets the settings for the controller in the list.



Line bright

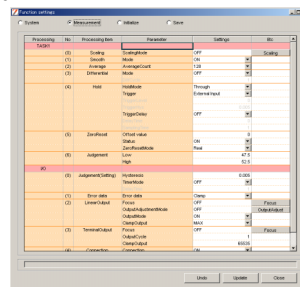

If you use SmartMonitor ZS Professional, which is sold separately, you can also do the following:

- Display multiple CH waveforms using multiple controllers.
- Perform logging for the measured value.

## Operating Environment

The following describes the operating environment for SmartMonitor ZS. Please check them.

Item	Condition
OS	Windows 10 (32 bit / 64 bit) Windows 7 (32 bit / 64 bit) Windows XP (At least Service Pack 3, 32 bit)
CPU	Intel Pentium III at least 1GHz(recommend 2GHz or more)
Memory	At least 1GB
Display	At least 1024 × 768 dots, at least 1.6 million Color

- Windows is a trademark or registered trademark of Microsoft Corporation.
- Other item names or system names are the trademarks or registered marks of other companies.

## Installation/Uninstallation Method

---

The following describes the preparations for using SmartMonitor ZS.

### ■ Installing SmartMonitor ZS



CHECK!

- Before you install SmartMonitor ZS, quit all other programs that are running. If virus detection software is enabled, installation may take time to complete.
- Log on as an Administrator or a user with system access rights.
- Install SmartMonitor ZS before installing the USB driver.

- 1. Turn your PC ON and startup up Windows.**
- 2. Insert your “SmartMonitor ZS” CD-ROM into the CD-DOM drive on your personal computer.**
- 3. Auto-run automatically displays the installation screen. Follow the on-screen instructions to install SmartMonitor ZS.**

### ■ Uninstalling SmartMonitor ZS



CHECK!

- Before you uninstall SmartMonitor ZS, quit all other programs that are running. If virus detection software is enabled, uninstallation may take time to complete.
- Log on as an Administrator or a user with system access rights.

- 1. Turn your PC ON and startup up Windows.**
- 2. Select [Control Panel] from the [Start] menu in the personal computer.**
- 3. Double-click [Add/Remove Programs].**
- 4. Select [SmartMonitorZS3] from the list and click the [Remove] button.**
- 5. Click the [Yes] button.**

## ■ Installing the USB driver

The USB driver must be installed on the personal computer to establish a connection between the personal computer and the Sensor Controller by the USB interface.



- The exclusive USB driver must be installed only when the Sensor Controller is connected to the personal computer for the first time. From the second startup onwards, the USB driver is automatically recognized and does not need to be re-installed.
- To install the USB driver, log on as an Administrator or a user with system access rights.
- Install SmartMonitor ZS before installing the USB driver.
- The error message “Failed to pass the Windows logo test” is sometimes displayed at USB installation. Press the [Continue] button to continue with the installation.

### 1. Turn your PC ON and startup up Windows.

### 2. Connect the Sensor Controller to the personal computer by the USB cable.



Attach the ferrite core (provided with the Sensor Controller) to the USB cable (provided with the Sensor Controller).

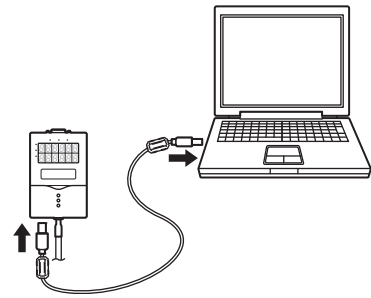
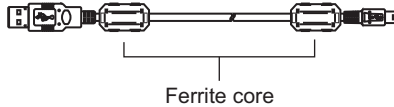

“Detected new hardware” will be displayed on the Windows tool bar, and the [New Hardware Detection Wizard] dialog box will appear.





3. Click the [Next>] button.
4. Select the [Search for a suitable driver for my disk (recommended)] radio button, and click the [Next>] button.



5. Mark the [CD-ROM drives] checkbox, and click the [Next>] button.

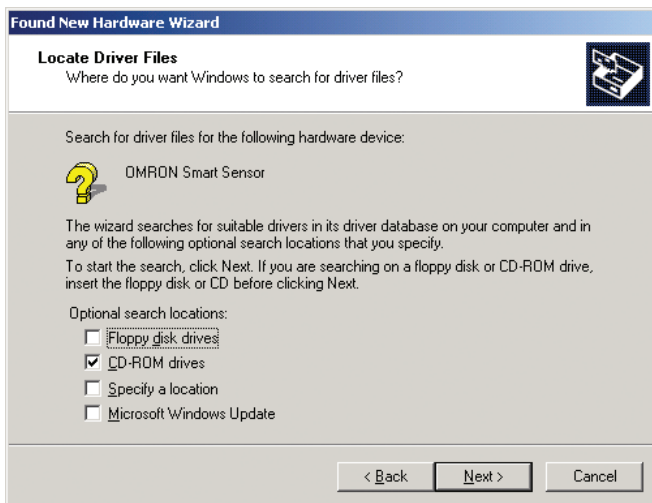

- When the Sensor Controller is not detected automatically Click the [Browse] button and select [USB] folder on the CD-ROM.
- To install on a personal computer not equipped with a CD-ROM drive Select [Specify directory], and specify the [Program Files]-[OMRON]-[SmartMonitorZS3]-[usb] folder.

6. Make sure that the optimum driver has been detected, and click the [Next>] button.

Installation begins.

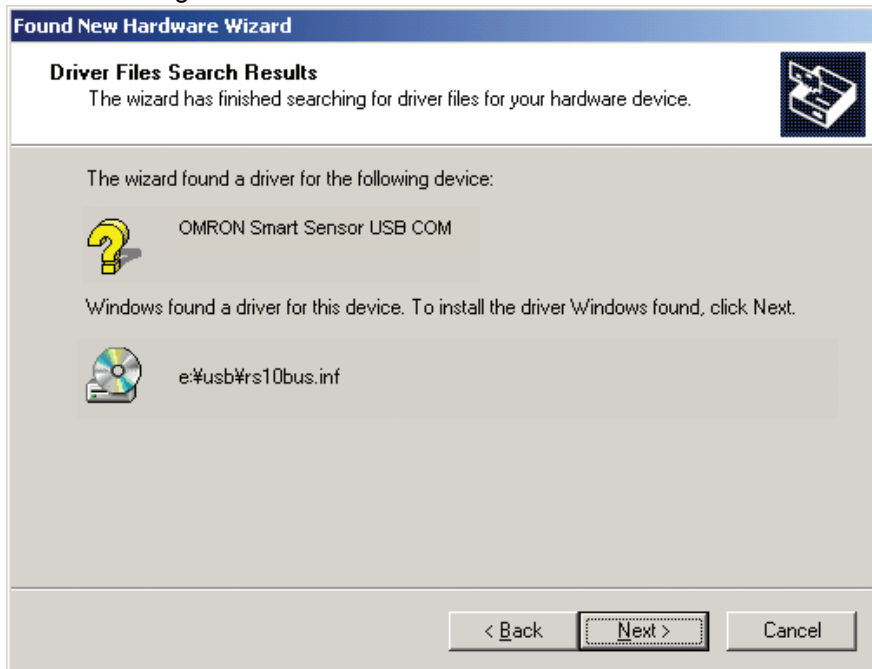

When installation ends, the completion message is displayed.

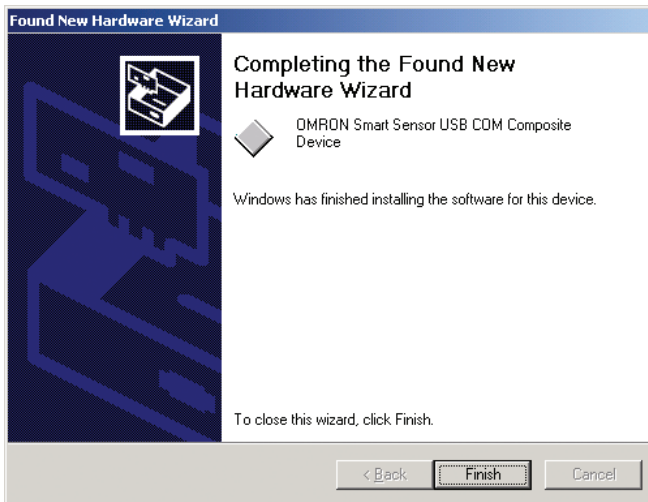

7. Click the [Finish] button.

The same screen in step 2 is displayed. Repeat the above procedure. This completes installation of the USB driver.

## Starting and Exiting SmartMonitor ZS

---

### ■ Start-up of SmartMonitor ZS

After installation is completed, start up SmartMonitor ZS by the following procedure.

1. Make sure that the Sensor Controller is connected to the personal computer.
2. Turn the Sensor Controller ON and set it to the RUN mode.
3. Select [Programs]-[OMRON]-[SmartMonitorZS3] from the Windows [Start] menu.

### ■ When the connection between the personal computer and Sensor Controller cannot be established

Check the COM port No. assigned on the personal computer in Device Manager.

1. Right-click [PC] on the Windows desktop and click [Properties].
2. Click [Device Manager].
3. Open [Port (COM/LPT)], and check which number COM in [OMRON Smart Sensor USB COM] or [USB Serial Device] is set to.
4. Set this COM port No. to the [Communication Settings] screen on Smart-Monitor ZS.



If "OMRON Smart Sensor USB COM" is not recognized in Device Manager, re-install the USB driver and reboot the personal computer.

### ■ Exiting SmartMonitor ZS

Exit SmartMonitor ZS by the following procedure.

1. Select [File]-[Close] in the SmartMonitor ZS menu bar.

MEMO

# Section3

## APPLICATION and SETTING EXAMPLES

☒ Measuring Height (basic)	3-2
☒ Measuring the Thickness of Transparent Objects	3-4
☒ Measuring the Vertex 2 (peak) in the Line Beam	3-6
☒ Measuring Multiple Items Simultaneously (Multi-Task)	3-8

# Measuring Height (basic)

This section describes the basic setting procedures for measuring height.

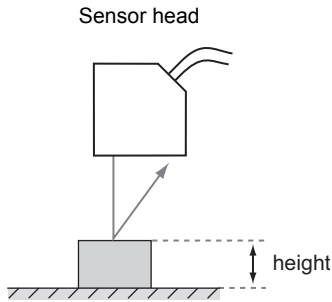

Name of the Controller and Key Code

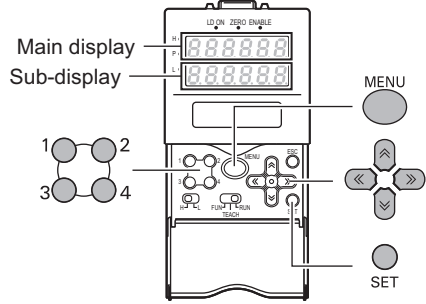

## Setting for sensing conditions

**1. Set the mode switch to FUN.**



**2. Select measurement mode in [SENSING]-[MODE].**

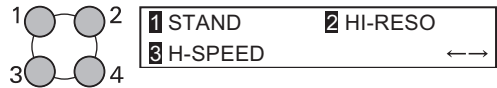

[HI-RESO]: Usually select this menu. A stable measurement can be performed while the effect of the front side of the workpiece is minimized.

[HI-SENS]: In addition to the effect of [HI-RESO], a measurement is stable even when the received light amount is insufficient. (black rubber, PCB, etc.)

**3. Select the mounting status of the Head in [SENSING]-[SETTING].**

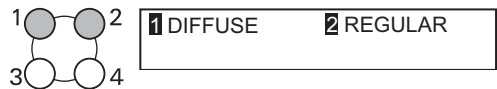

**4. Select the material of the workpiece in [SENSING]-[OBJECT].**

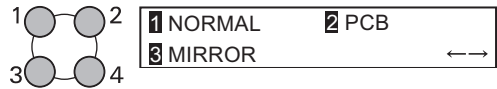

[NORMAL]: Usually select this menu.

[PCB] : When a laser beam passes through an object like PCB and there is a diffused reflection effect.

[MIRROR]: For a mirror

[GLASS] : For glass

Saving the Settings

5. Set the mode switch to RUN.



6. Select [Yes] and save the settings.

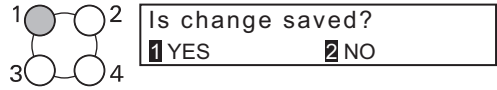

Measurement

7. Check the measured value.

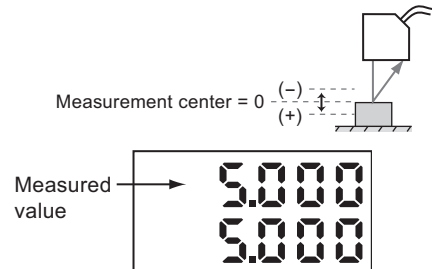

## Measuring the Thickness of Transparent Objects

If you already know the glass thickness, you can adjust the scaling with reference to the thickness, and easily measure the thickness of a transparent object.

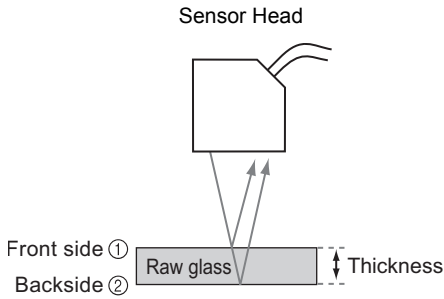

[Points for installation]

- For regular reflection heads (such as ZS-LD20T)  
By fixing the Sensor Head to a position such that it is kept in parallel with the front side of the workpiece, you can perform high-precision measurement. When you install the Sensor Head, we recommend that you match the front side of the workpiece with the reference surface of the Sensor Head, and then bring up the Sensor Head horizontally and install it.

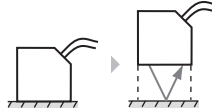

- For diffuse reflection heads  
Adjust the position of the Sensor Head while checking the display of the emitted light amount and received light amount. Adjust the position of the Sensor Head such that the emitted light amount becomes the minimum compared to 1,000 for the received light amount.

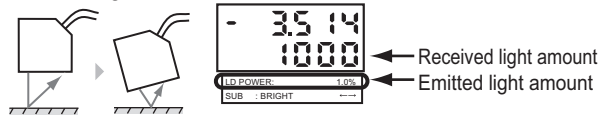

Switching the Display of the Measured Value p.4-2

### Setting for sensing conditions

1. Set the mode switch to FUN.



2. Select [REGULAR] in [SENSING]-[SETTING].

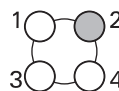

1 DIFFUSE 2 REGULAR

3. Select [THICK]-[MODE1] in [SENSING]-[OBJECT].

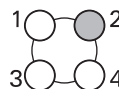

1 GLASS 2 THICK





Setting Scaling

4. Set the actual workpiece within the measuring range.

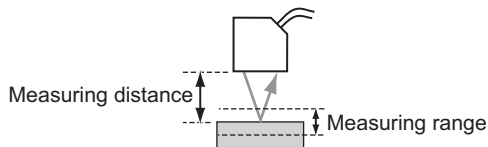

5. Select [OUTPUT]-[SCALING]-[ON]-[AUTO].

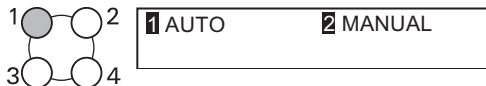

When you want to execute [SCALING FOR GLASS THICKNESS], set the workpiece within the measuring range. In the status in which a measurement cannot be performed, you cannot set the scaling (automatic).

6. Enter the actual size of the glass thickness.

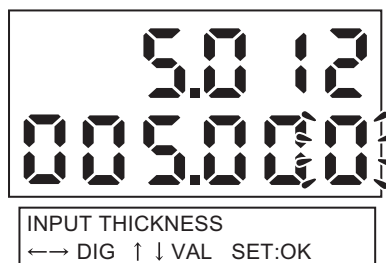
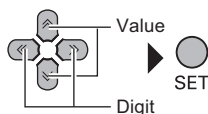

Saving the Settings

7. Set the mode switch to RUN.



8. Select [Yes] and save the settings.

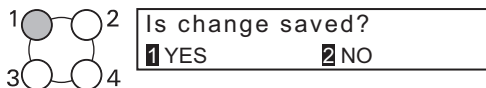

Measurement

9. Check the measured value.

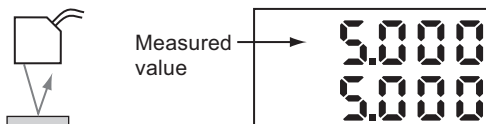

When a measurement is not stable Select [THICK]-[MODE2] at the step 3. When you select [MODE2], the mode is switched to 2-area measurement mode that executes an adjustment for suitable received light amount for the front side and back side of the glass respectively. When you use SmartMonitor ZS, you can adjust the area while checking the received light amount.

Setting Measurement Object p.5-9

## Measuring the Vertex 2 (peak) in the Line Beam

The following describes the setting procedure for measuring a small vertex.

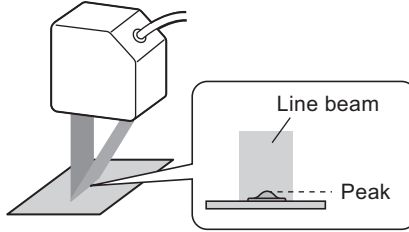

1. Set the mode switch to FUN.



2. Select [ON] in [SYSTEM]-[MULTI-TASK].

The confirmation message is displayed. Select [OK].

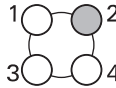

Setting peak (TASK1)

3. Press the MENU key to display the TOP menu.

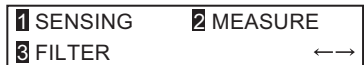

4. Press the ESC key to display the TASK switching menu, and select [TASK1].



5. Select [PEAK] in [MEASURE]-[TASKSET].

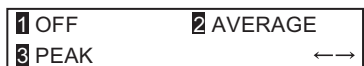

Saving the Settings

**6. Set the mode switch to RUN.**



**7. Select [Yes] and save the settings.**

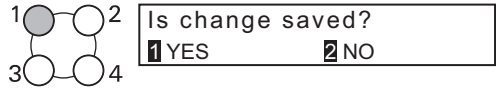

Measurement

**8. Check the measured value.**

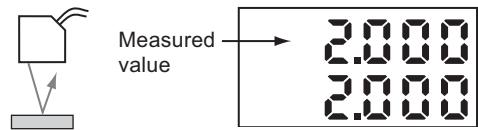

You can measure the bottom or step using the same procedure. Select [BOTTOM] or [STEP] at step 5.

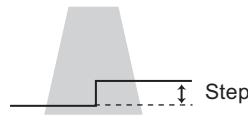
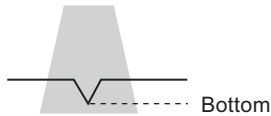

## Measuring Multiple Items Simultaneously (Multi-Task)

If you use the multi-task function, you can measure the height and surface fluctuation simultaneously. The following describes the procedure for setting "height" for TASK1 and "surface fluctuation" for TASK2.

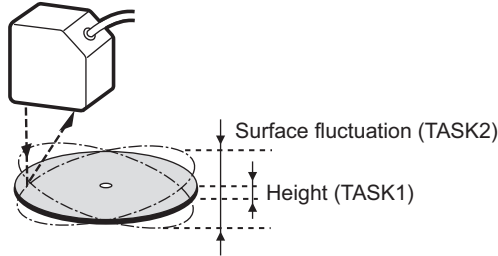

- 1. Set the mode switch to FUN.**



- 2. Select [ON] in [SYSTEM]-[MULTI-TASK].**

The confirmation message is displayed. Select [OK].

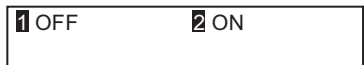
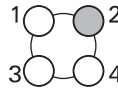

Setting height (TASK1)

- 3. Press the MENU key to display the TOP menu.**

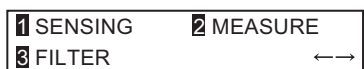

- 4. Press the ESC key to display the TASK switching menu, and select [TASK1].**

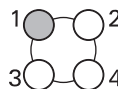

- 5. Select [AVERAGE] in [MEASURE]-[TASKSET].**

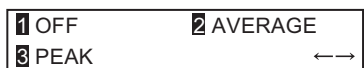
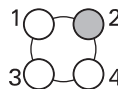

**6.** Select [AVERAGE] in [OUTPUT]-[HOLD]-[TYPE].



1 P - P	2 AVERAGE
3 SAMPLE	↔

**7.** Set the mode switch to TEACH.



**8.** Select [Yes] and save the settings.



Is change saved?	
1 YES	2 NO

**9.** Set the threshold value.

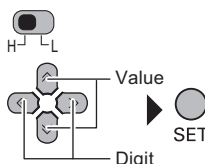

Setting surface fluctuation (TASK2)

**10.** Set the mode switch to FUN.



**11.** Select [Yes] and save the settings.



Is change saved?	
1 YES	2 NO

**12.** Press the ESC key to display the TASK switching menu, and select [TASK2].



1 TASK1	2 TASK2
3 TASK3	4 TASK4

**13.** Select [AVERAGE] in [MEASURE]-[TASKSET].



1 OFF	2 AVERAGE
3 PEAK	↔

**14.** Select [P-P] in [OUTPUT]-[HOLD]-[TYPE].



1 P - P	2 AVERAGE
3 SAMPLE	↔

**15.** Set the threshold value using the same steps from 7 to 9.

Measurement

**16.** Set the mode switch to RUN.



**17.** Select [Yes] and save the settings.

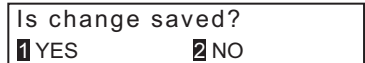
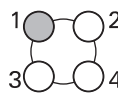

**18.** Measure the workpiece while pressing the UP key.



Sampling is performed while the UP key is being pressed.

**19.** Check the measured value.

You can check the measured value for each TASK by switching the display.

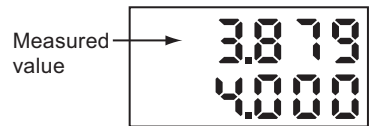
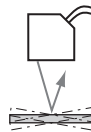

Switching the Display of the Measured Value p.4-2



When a measurement is performed using the actual line, the Sensor Controller can start the measurement by external input or self-trigger.

CHECK!



p.5-19

# Section4

## FUNCTIONS AND OPERATIONS USED DURING OPERATION

☒ Switching the Display of the Measured Value	4-2
☒ List of Key Operations in RUN Mode	4-4
☒ Zero Reset Operation	4-5
☒ Threshold Setting	4-7
☒ Bank Switching (change of device setup)	4-10

## Switching the Display of the Measured Value

In RUN mode, You can switch the display for main/sub-display during the operation. You can check the threshold value and resolution while displaying the measured value according to the application.

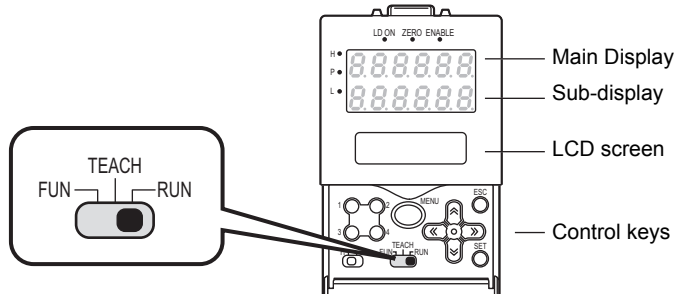

In this mode, measured values are displayed on the main display, and threshold values and other information are displayed on the sub-display.

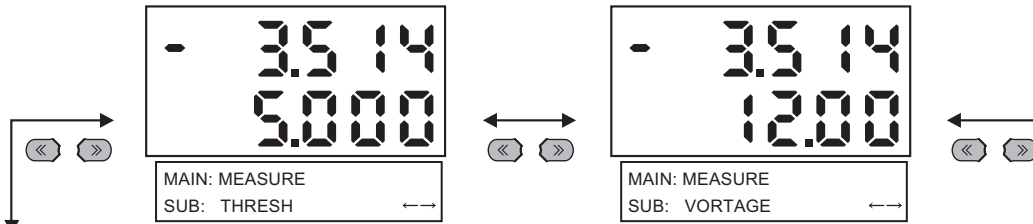

When [TERMINAL BLOCK]-[OUTPUT] is set (\*3)

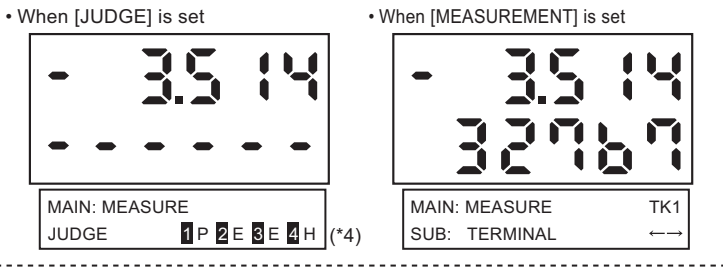

For Multi-Task mode (\*2)

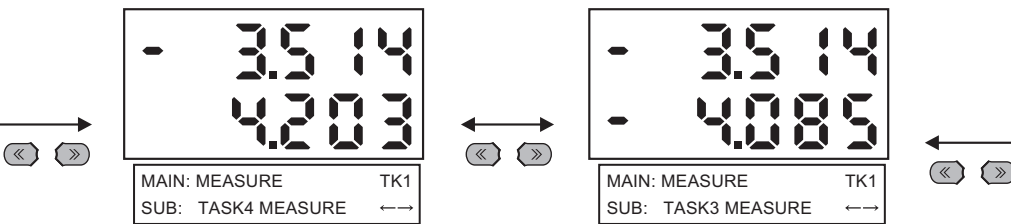

\*1) TKx on the LCD screen indicates that the measured value of the current TASKx is displayed in the main display. Switch TASK that is displayed in the main display by using the function keys.

\*2) It is displayed only in Multi-Task mode. Up to two measured values for tasks can be displayed in parallel in the main display and sub-display.







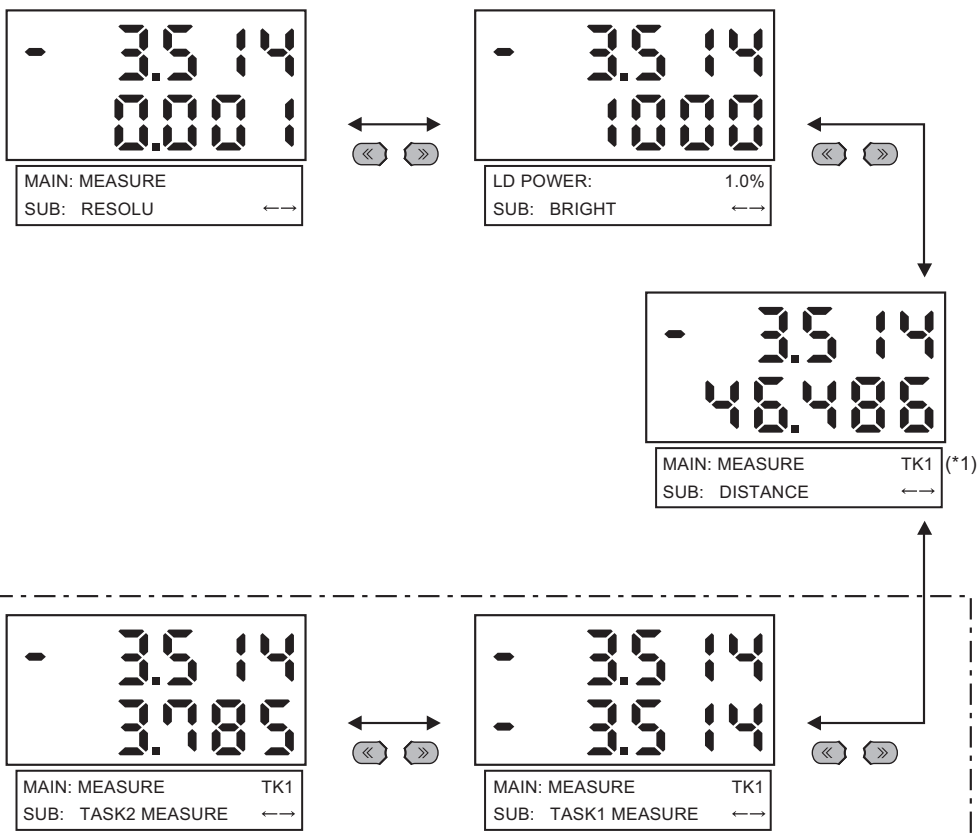

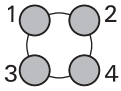

Details displayed on the sub-display

Display Details	Description
THRESH	Displays the HIGH/LOW threshold values according to the setting of the threshold switch.
VOLTAGE (CURRENT)	Displays the voltage (current) to be linearized. The display details change according to the setting of the current/voltage switch. (Values displayed here are reference values only. These values differ from actual linear output values.)
RESOLU	Displays the fluctuation width (peak to peak) of the measured value over a fixed amount of time.
BRIGHT	Displays the current received light amount. The current emitted light amount also is displayed on the LCD upper section. When you attach the Sensor Head, adjust the position of the Sensor Head so that the emitted light amount is as small as possible compared to the received light amount (1000).   Inside of the Sensor Controller, the emitted light amount is automatically adjusted in the range from 0.1 % to 80 % so that the received light amount reaches 1000. Even if the emitted light amount reaches the maximum 80 %, but the received light amount is not close to 1000, change the settings to switch the measurement mode to HI-SENS or to increase the gain to increase the received light amount. <b>CHECK!</b>
DISTANCE	Displays the distance from the Sensor Head to the workpiece.
TASK_MEASURE	In Multi-Task mode, this menu displays the measurement result for another TASK.
TERMINAL	Displays the value that is output to ZG-RPD.
JUDGMENT RESULT	



- \*3) The display details vary according to the option for OUTPUT of TERMINAL BLOCK. It is not displayed when you select [NONE] in [TERMINAL BLOCK]-[OUTPUT].
- \*4) JUDGEMENT RESULT is displayed for each TASK (P: PASS, E: ERROR, H: HIGH, L: LOW). In the screen examples shown above, TASK1 is PASS, TASK2 and TASK3 are ERROR, and TASK4 is HIGH.

## List of Key Operations in RUN Mode

Key		Role
Function keys		In Multi-Task mode, this key switches the task. The key numbers from 1 to 4 correspond to the task numbers.
← LEFT key → RIGHT key	 	Changes sub-display content.
↑UP key ↓ DOWN key	 	↑UP key : Executes trigger input. ↓ DOWN key: Executes reset input.
MENU key		Displays the display customize menu.
SET key		Executes a zero reset.
ESC key		Hold down for at least two seconds to cancel a zero reset.

# Zero Reset Operation

When the zero reset function is used, the reference value "0" is registered as the height and the measured value can be displayed and output as a positive or negative deviation (tolerance) from the reference value. In RUN mode, the measured value can be reset to 0 at any timing during measurement.

Example 1: Using the height of sensing object registered as the reference value and the tolerance output as the measured value

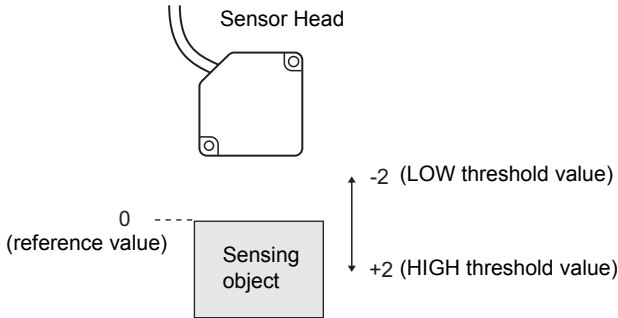

Example 2: Using the height of sensing object as the measured value with an offset set to 10

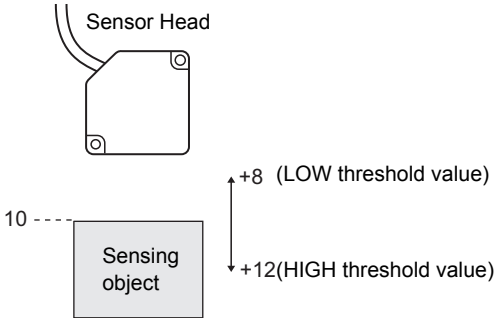

Example 3: Using zero reset to measure steps in sensing object (zero reset at each measurement)

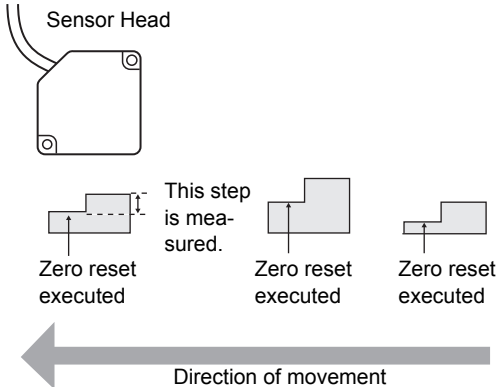

## ■ Executing/Canceling Zero Reset

When the zero reset function is used, the measured value can be reset to a reference value of 0 when the ENT key is pressed or an external signal is input.

---

### Executing Zero Reset

---

1. Place the reference sensing object in position.

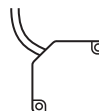

2. Press the SET key.

The zero reset indicator illuminates and the current measured value is registered as 0 (zero).

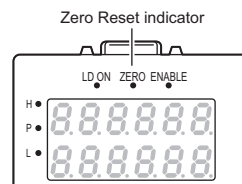

Executing/Canceling by External Signal Input p.6-23



CHECK!

When a zero reset is executed, the linear output becomes the voltage (or current) value at the center of the two preset points. Linear output becomes roughly 0 V (12 mA) when focus is not set.

---

### Canceling Zero Reset

---

1. Press and hold the ESC key for 2seconds or longer.



Setting the Zero Reset Function p.5-22

# Threshold Setting

Switch to the TEACH mode and set the range in order for the measured value to be judged as PASS.

Both HIGH and LOW threshold values are set. There are three judgment outputs: HIGH, PASS and LOW.

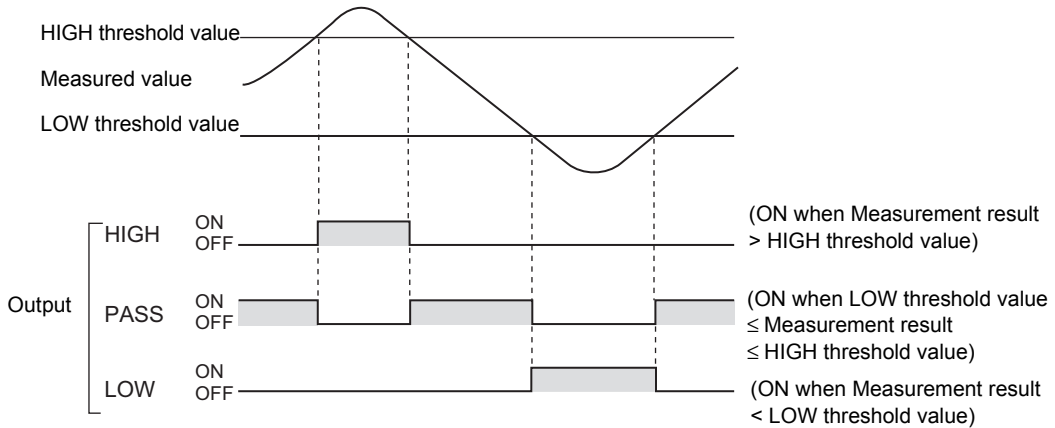

There are two ways of setting the threshold value.

Method	Details
TEACHING (MENU key)	Performs measurement and uses the measurement results to set threshold values. Position teaching is useful when threshold samples, i.e., with the upper and lower limits, can be obtained beforehand.
DIRECT IN (L/R/UP/DOWN keys)	The threshold values can be set by directly inputting numerical values. Direct input is useful when you know the dimensions for an OK judgment or when you want to fine-tune threshold values after teaching.



- Hysteresis (hysteresis width) can also be set to threshold values. Set hysteresis when judgments are unstable to prevent chattering.

CHECK!



Setting Judgment Output (HYS) p.6-7

- When setting threshold values while still connected to an external device, set the Sensor Controller's LD-OFF input to ON so that the output to the external device remains unchanged. Judgment outputs in TEACH mode are the same as in RUN mode, i.e., HIGH, PASS, and LOW.
- In Multi-Task mode, you can select the task to be displayed. The function keys correspond to the tasks; Press the function key for the number of the task to be displayed.  
(The currently selected task is displayed as "TKX" on the LCD display.)

TEACHMODE	TK 1
MENU: TEACHING	↑

TASK No.

**TEACHING**

Performs measurement and uses the measurement results to set threshold values. Teaching is useful when threshold samples, i.e., with the upper and lower limits, can be obtained beforehand.

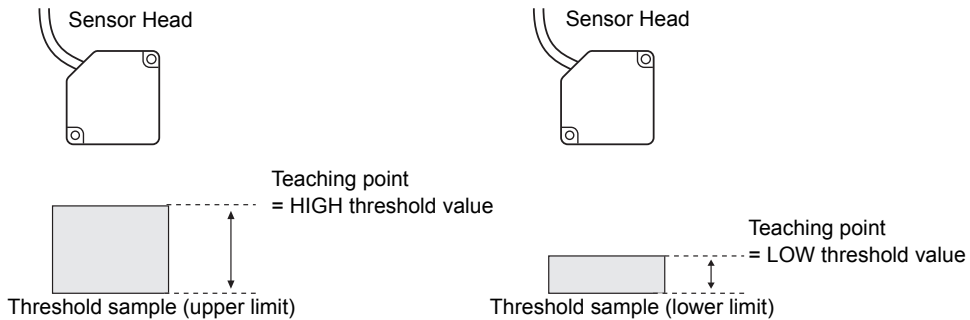

Hold, trigger, and scaling settings that have been made before teaching are reflected in the teaching measurements.

The following describes the operation method using the procedure for setting the HIGH threshold value as an example.

**1. Set the mode switch to TEACH.**

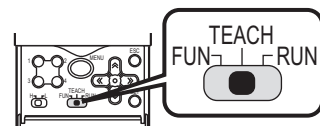

**2. Switch the threshold switch to “H” to set the HIGH threshold value.**

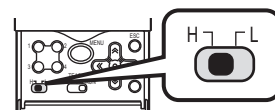

**3. Set the workpiece.**



**4. Press the MENU key to apply the setting.**



The applied threshold value will be displayed on the sub-display.

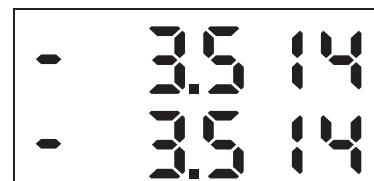

TEACHMODE  
MENU: TEACHING

## ■ DIRECT IN

The threshold values can be set by directly inputting numerical values. Direct input is useful when you know the dimensions for an OK judgment or when you want to fine-tune threshold values after teaching.

The following describes the operation method using, as an example, the procedure for setting the HIGH threshold value by directly entering it.

### 1. Set the mode switch to TEACH.



### 2. Switch the threshold switch to "H" to set the HIGH threshold value.



### 3. Enter the setting value you want to change.

The current measured value is displayed on the main display, and the offset value is displayed on the sub-display.

← → : Change the digit,  
↑ ↓ : Change the value

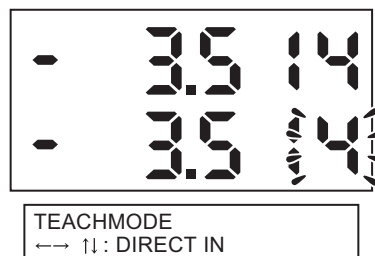
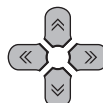

### 4. Press the SET key to apply the setting.

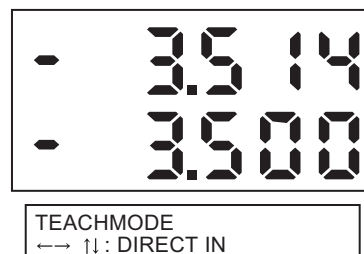

CHECK!

If you want to cancel the threshold value that is being changed, press the ESC key.

# Bank Switching (change of device setup)

ZS-HL can hold up to four sets of settings, which are called a bank. When the device setup is changed, you can switch the bank externally.

- What is bank?

The settings for measurement



are held as one bank.

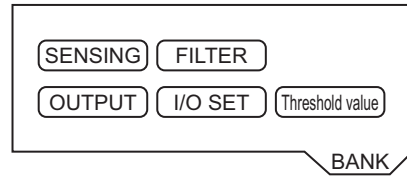

- Example of bank switching for settings

If you register settings of various classes,

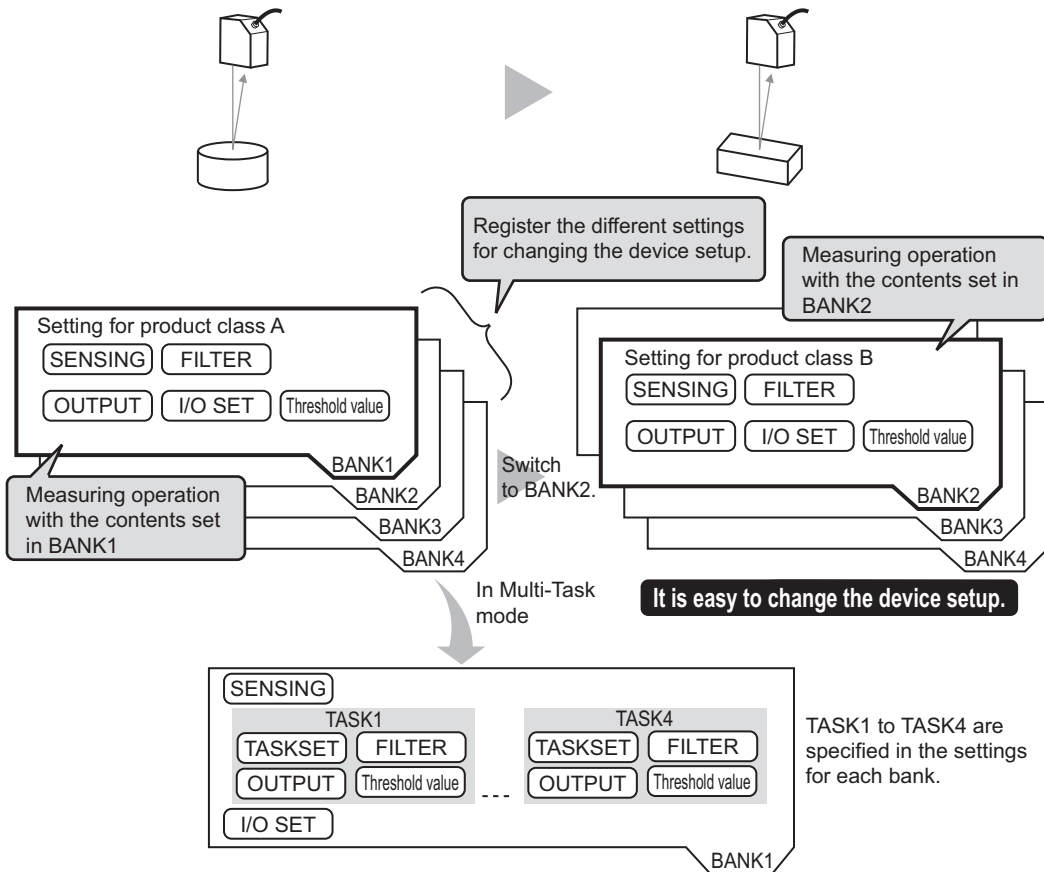

If only the "threshold value" is different in the settings for a bank, by changing the mode of the bank, you can increase the number of banks from 4 to 32.

CHECK!



Selecting the bank mode p.5-28



● **Bank Switching by Key Operations**

▶ FUN Mode-[BANK]-[CHANGE]

**1. Select the bank number.**

The current bank number is displayed on the main display.



1 BANK1	2 BANK2
3 BANK3	4 BANK4

● **Bank Switching by External Signal Input**

You need to change the function assignment for input signals.

-  - Changing the Assignment of Input Signals p.6-17
- Wiring p.2-10



- You can also switch the bank by entering the CompoWay/F or non-procedural command from Smart-Monitor ZS.
- If the bank mode is set to [JUDGMENT VALUE], the bank cannot be switched at the external signal input because the number of banks increases to 32.

MEMO

# Section5

## SETTINGS FOR FUNCTIONS

☒ Basic Operations of Sensor Controller	5-2
☒ Using the Multi-Task Function	5-4
☒ Setting for Sensing Conditions	5-6
☒ Setting the Filter Function	5-12
☒ Setting Output Processing of Sensing Information	5-14
☒ Setting for Measurement of Characteristic Points	5-24
☒ Setting Display Method	5-25
☒ Setting the System Environment	5-27
☒ Changing the Way of Obtaining Banks	5-28
☒ Saving the Settings Data	5-29
☒ Clearing the Settings	5-29

# Basic Operations of Sensor Controller

## Displays and Key Operations

The settings are mainly specified in FUN mode. The LCD screen displays the setup menus in FUN mode. The No. at the top of each menu corresponds to a function key. “← →” displayed at the top right of the LCD screen indicates that the setup menu is made up of two or more pages. Scroll pages by the LEFT or RIGHT key.

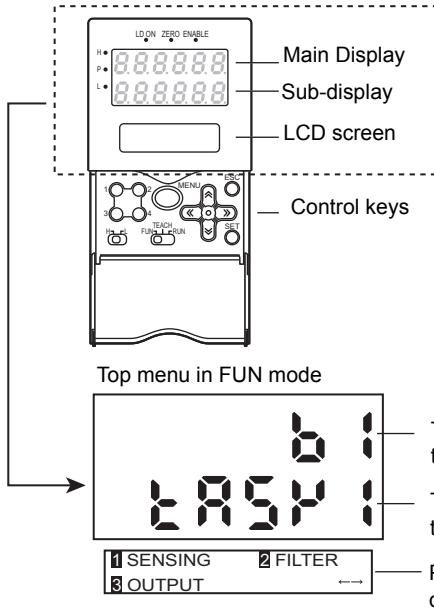

Alphabet characters that appear on the digital displays

A	B	C	D	E	F	G	H	I
R	b	c	d	E	F	G	h	I
J	K	L	M	N	O	P	Q	R
U	V	L	ñ	n	o	P	q	r
S	T	U	V	W	X	Y	Z	
S	t	U	v	Y	ü	y	z	

The currently selected bank No. will be displayed on the main display.  
The currently selected task No. will be displayed on the sub-display.  
Pressing the MENU key in FUN mode returns to the display.

### Key Operations

Key		Role
Function keys		Directly sets the No. preceding the items displayed on the LCD screen.
← LEFT key → RIGHT key		The function changes depending on the settings. - Scrolls pages in list menus. - Selects the digit of numerical values.
↑ UP key ↓ DOWN key		Changes numerical values during input.
MENU key		Displays the top menu.
SET key		Applies the item you are setting up.
ESC key		Returns to the previous menu.

The following example describes basic operations for changing the measurement mode to [HI-RESO].

- 1. Press function key 1 representing [SENSING].**

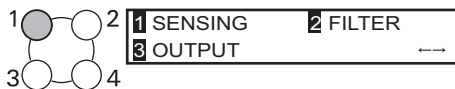

- 2. Press function key 1 representing [MODE].**

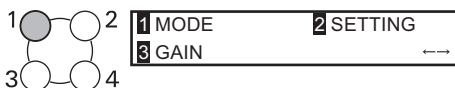

The currently selected No. is displayed flashing.



- 3. Press function key 2 representing [HI-RESO].**

The “Complete!” message is displayed.

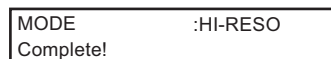

- 4. Press the MENU key to return to the top menu.**

Pressing the ESC key returns to the previous menu.



# Using the Multi-Task Function

In the ZS-HLDC Series, you can set multiple measurement processing for one sensing condition. This measurement processing is called a “task.”

- Application example: Measure the height and surface fluctuation simultaneously.

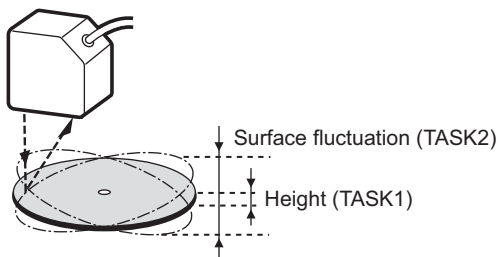

Measuring Multiple Items Simultaneously p.3-8

## ■ “Single-Task Mode” and “Multi-Task Mode”

You can use the two modes appropriately according to the measurement details; for standard measurement, you can use “Single-Task mode” that can be set easily, and when you need detailed settings, for example when you measure and judge multiple characteristic points simultaneously, you can use “Multi-Task mode”. In “Multi-Task mode”, four tasks are provided. You can measure and judge multiple characteristic points simultaneously because you can measure the desired characteristic point such as peak, bottom, and average for each task.

[Single-Task]

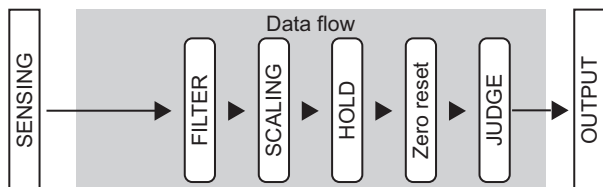

[Multi-Task]

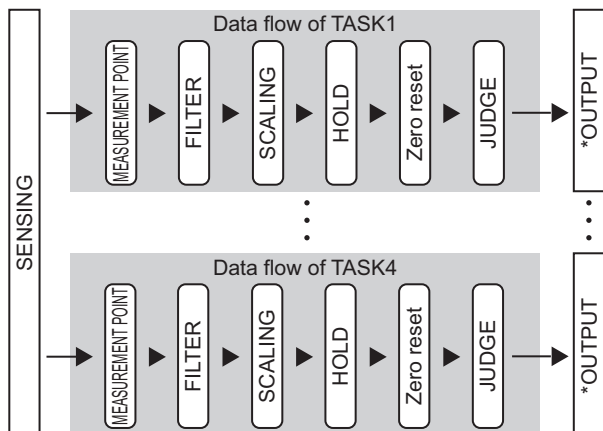

\* Output

- Linear output  
Select one TASK that you want to output.
- Judgment output  
- Select one TASK that you want to output.  
- When ZG-RPD is connected, you can output a judgment for four TASKs.

- Terminal block output  
If you connect ZG-RPD, you can output data for up to four TASKs.
- Digital output (USB/RS-232C)  
Continuously outputs four TASKs.



It is used to display a graph screen or do logging with SmartMonitor ZS or external devices.

## Switching to Multi-Task Mode

Select “Single-Task mode” when you perform one measurement processing for one sensing, and select “Multi-Task mode” when you measure and judge multiple characteristic points simultaneously.

### ► FUN Mode-[SYSTEM]-[MULTI-TASK]

Setting	Description
OFF	Single-Task mode is selected. (default value)
ON	Multi-Task mode is selected.

 Differences in the menu tree according to the mode p.16

## Selecting Tasks

When you set [MULTI-TASK] to ON, select the task number and then specify the various settings. The following describes the method of selecting the task number.

### ► FUN Mode

- 1. Press the MENU key to display the TOP menu.**



- 2. Press the ESC key.**  
The TASK selection menu will be displayed.



- 3. Select the task number.**  
The currently selected task is displayed on the sub-display.

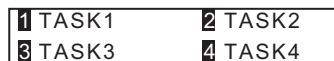

## Setting for Sensing Conditions

Set the conditions to be used for detecting workpieces by the sensor.

### Setting Measurement Mode

#### ■ Setting the Measurement Mode

Set the measurement mode according to the measurement details (such as moving speed and measurement point of workpiece).

Select the measurement mode based on the items (e.g. speed, precision, or sensitivity) that you want to give priority to in measurement.

#### ▶ FUN Mode-[SENSING]-[MODE]

Setting	Description
STAND	This is the standard measurement mode. (sampling frequency: approx. 500 $\mu$ s)
HI-RESO	Select this mode to measure workpieces with sensitivity set high. (default value) (sampling frequency: approx. 2 ms)
HI-SPEED	Select this mode to measure workpieces at high speed. However, you cannot select this menu in Multi-Task mode. (sampling frequency: the fastest speed of approx. 110 $\mu$ s)
HI-SENS	Select this mode to measure workpieces with sensitivity set high. In this measurement mode, sensitivity to received light is much better than the High-Resolution mode as the sampling time is longer. (sampling frequency: approx. 4 ms)



- In High-Speed mode, the sampling cycle changes according the actual settings. (When only the average count is set, the sampling cycle becomes the maximum speed (approx. 110  $\mu$ s).)  
Check the actual sampling cycle at [INFO]-[CYCLE] from the top menu.
- In High-Speed mode, the smooth function is changed to OFF. In modes other than High-Speed mode, the smooth function is changed to ON.



## ■ Setting Custom Mode

If you cannot perform measurement in the provided measurement modes, use Custom mode.



You can change additional lines and exposure time, so that a measurement can be performed under conditions suitable for the surface status of the workpiece.



Set in the order of [LINE] → [EXPOSE] → [SKIP].

If you set an additional line, its exposure time is automatically determined. If the light amount is still insufficient, set the exposure time. When [SKIP] is set to ON in this state, the effective line width is doubled.

### ▶ FUN Mode-[SENSING]-[MODE]

Setting		Description
CUSTOM	LINE (number of additional lines)	Set this item to make it mode difficult (increase the number of additional lines) for measurement to be influenced by the state of the workpiece surface, or to measure at a single pinpoint on the workpiece (reduce the number of additional lines). Range: 1 to 200 (The maximum number of lines changes according to the exposure time setting.)  Usage Width of Line Beam p.8-19
	EXPOSE (exposure time)	Set this item when exposure is insufficient and the exposure time must be lengthened to increase the amount of received light. - For Single-Task mode Range: 0.2 ms to 20 ms - For Multi-Task mode Range: 0.5 ms to 20 ms   When the internal measurement time is longer than the exposure time setting, the exposure time (= sampling cycle) sometimes is greater than the setting. <b>CHECK!</b> Check the actual sampling cycle in [SYSTEM]-[INFO]-[CYCLE].
	SKIP	Set this item to extend the measurement line width without changing the measuring time. The effective line width is doubled when this setting is ON. Range: ON, OFF

## Setting GAIN

You can set the CMOS gain so that even workpieces having an extremely low amount of reflected light or workpieces having a large tilt can be measured stably.



The measurement resolution sometimes drops when a large gain is set. Also, this function increases the gain on the light receiving side. Therefore, please note that the Sensor Controller can be easily affected by ambient light.

### ▶ FUN Mode-[SENSING]-[GAIN]

Setting	Description
1, 2, 3, 4, 5	Adjusts the internal gain of the CMOS image sensor. (default value: 1) 1 (gain small) → 5 (gain large)

## Setting Head Installation

Set how the Sensor Head is installed.

This setting is automatically specified according to the type of the connected Sensor Head. However, if the Head is installed at an angle and the default value and reflection angle are changed, change the settings according to the status of the head installation.

### ► FUN Mode-[SENSING]-[SETTING]

Setting	Description
DIFFUSE	Select this item when the Sensor Head is installed for diffuse reflection sensing.
REGULAR	Select this item when the Sensor Head is installed for regular reflection sensing.

## Setting the Emitted Light Amount

Set the amount of light emitted from the Sensor Head to match the state of the workpiece surface.



CHECK!

The response may slow down if workpieces having differing reflection factors such as black-and-white workpieces are measured with FUN mode set to [AUTO]. In this case, narrow the adjustment range by setting [RANGE]. If this does not increase the response speed to keep up with measurement, select [FIXED].

### ► FUN Mode-[SENSING]-[LASER]

Setting	Description																									
AUTO	Automatically adjusts the emitted light amount according to the reflection factor of the workpiece. Note that the response time varies with each measurement. (default value)																									
RANGE	<table border="1"> <thead> <tr> <th>UPPER</th> <th>LOWER</th> <th>Level</th> <th>Sensitivity</th> <th>Color of workpiece</th> </tr> </thead> <tbody> <tr> <td></td> <td></td> <td>0.1 %</td> <td>Low</td> <td>Bright</td> </tr> <tr> <td></td> <td></td> <td>•</td> <td></td> <td></td> </tr> <tr> <td></td> <td></td> <td>•</td> <td></td> <td></td> </tr> <tr> <td></td> <td></td> <td>80 %</td> <td>High</td> <td>Dark</td> </tr> </tbody> </table>	UPPER	LOWER	Level	Sensitivity	Color of workpiece			0.1 %	Low	Bright			•					•					80 %	High	Dark
UPPER	LOWER	Level	Sensitivity	Color of workpiece																						
		0.1 %	Low	Bright																						
		•																								
		•																								
		80 %	High	Dark																						
FIXED	Sets the emitted light amount to a fixed value. For reference levels, see [RANGE]. Range: 0.1 % to 80 %.																									

## Setting Measurement Object

Set the type of workpiece to be measured.  
In Multi-Task mode, [THICK] is not displayed.

### ► FUN Mode-[SENSING]-[OBJECT]

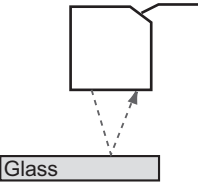
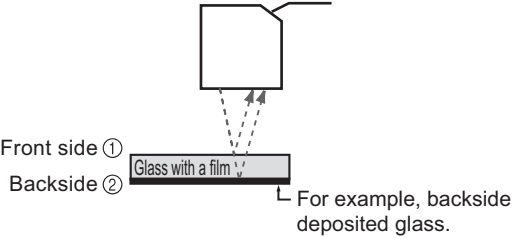
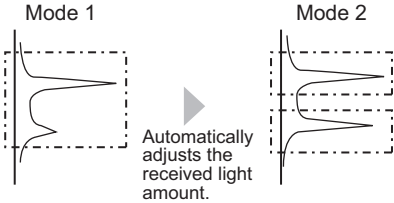
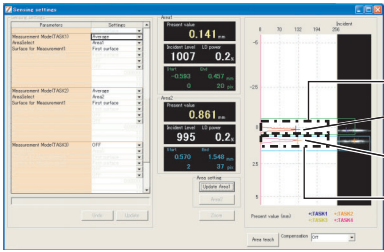
Setting	Description
STAND	Usually, select this setting. (default value)
PCB	Select this setting for workpieces such as PCBs through which light penetrates.
MIRROR	Select this setting for workpieces having a mirror surface.
Glass	<p>Mode1</p> <p>Select this mode to measure glass at high speed. (This is not displayed in Multi-Task mode.)</p> 
	<p>Mode2</p> <p>Select this mode when you want to measure glass stably. This is effective when measuring the thickness of glass having different reflection factors on the front side ① and the backside ② such as backside deposited glass. (This is not displayed in Multi-Task mode.)</p>  <p>Front side ① Backside ②</p> <p>For example, backside deposited glass.</p> <p>When MODE2 is selected, two areas are measured and the measured value that is closer to the Sensor Head is output as the result of the front side of the glass. When MODE2 is selected, the measurement area is set for the front side and back-side of the glass respectively, and an adjustment is performed for a suitable received light amount for each area.</p>  <p>Mode 1</p> <p>Mode 2</p> <p>Automatically adjusts the received light amount.</p> <p>When you use SmartMonitor ZS, you can adjust the area while checking the received light amount.</p>  <p>Area of the front side</p> <p>Received light amount of the front side</p> <p>Received light amount of the backside</p> <p>Area of the backside</p>

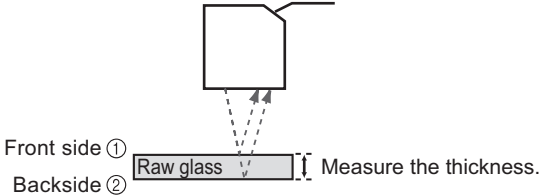
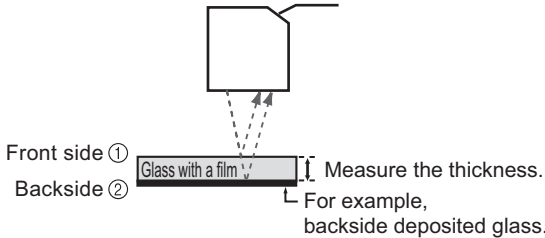
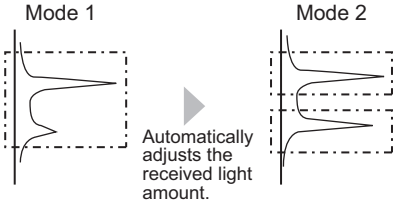
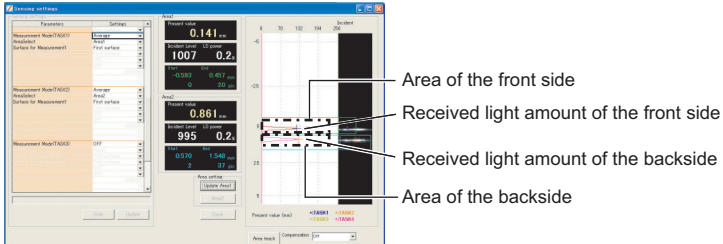
Setting	Description
THICK	<p>Mode1</p> <p>Select this mode to measure the thickness of glass at high speed. Measures the thickness between ① and ②. (This is not displayed in Multi-Task mode.)</p>  <p>Front side ① Backside ②</p>
	<p>Mode2</p> <p>Select this mode when you want to measure the thickness of glass stably. This is effective when measuring the thickness of glass having different reflection factors on the front side ① and the backside ② such as backside deposited glass. (This is not displayed in Multi-Task mode.)</p>  <p>Front side ① Backside ②</p> <p>For example, backside deposited glass.</p> <p>When MODE2 is selected, the measurement area is set for the front side and backside of the glass respectively, and an adjustment is performed for a suitable received light amount for each area.</p>  <p>Mode 1                      Mode 2</p> <p>Automatically adjusts the received light amount.</p> <p>When you use SmartMonitor ZS, you can adjust the area while checking the received light amount.</p>  <p>Area of the front side Received light amount of the front side Received light amount of the backside Area of the backside</p>



When you set GLASS (MODE2) or THICK (MODE2) for the measurement object, the following parameters are initialized.

- SMOOTH
- AVERAGE



When you set [GLASS] or [THICK], SmartMonitor ZS displays TASK1/2/3 in spite of Multi-Task Mode OFF. Set [GLASS] or [THICK] of TASK3, and then reflect to the Sensor Controller. Even though you change the settings of TASK1/2, the Sensor Controller does not be reflected.

## Setting Mutual Interference Prevention

Mutual interference between two Sensor Heads can be prevented by shifting the laser beam emission timing. Use this function when Sensor Heads must be set up inside an area where mutual interference is likely to occur or when a transparent workpiece will be measured sandwiched between two Sensor Heads.

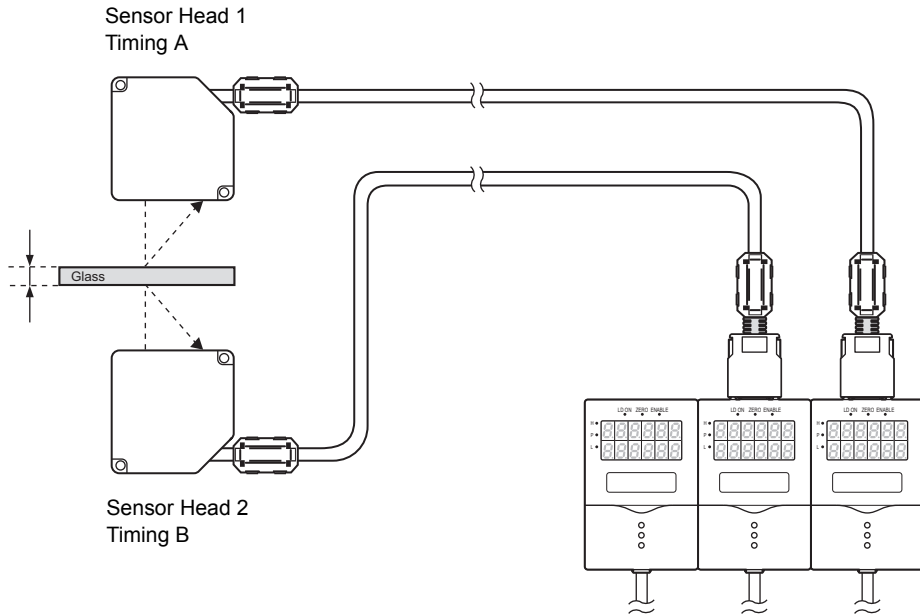

### ► FUN Mode-[SENSING]-[SYNC]

Setting	Description	
OFF	The mutual interference prevention function is not used. (default value)	
ON	Timing A	Sets the light emission timing to timing A.
	Timing B	Sets the light emission timing to timing B.



The sampling frequency is changed when the mutual interference prevention mode is enabled.

- 8 times in Standard, High-Resolution and High-Sensitivity modes
- About 15 times in the High-Speed mode

The measurement cycle is also influenced by other settings.

Check the sampling cycle in FUN Mode-[SYSTEM]-[INFO]-[CYCLE].



- The same sensing mode must be set to each controller when the mutual interference prevention mode is used. When [HI-SPEED] or [CUSTOM] is selected as the measurement mode, the same conditions must be set. Setting different conditions will result in a sampling cycle on each controller and mutual interference can no longer be prevented.
- When GLASS (MODE2) or THICK (MODE2) is set, mutual interference prevention function does not operate.

# Setting the Filter Function

Set the conditions for filtering information obtained from the sensor.

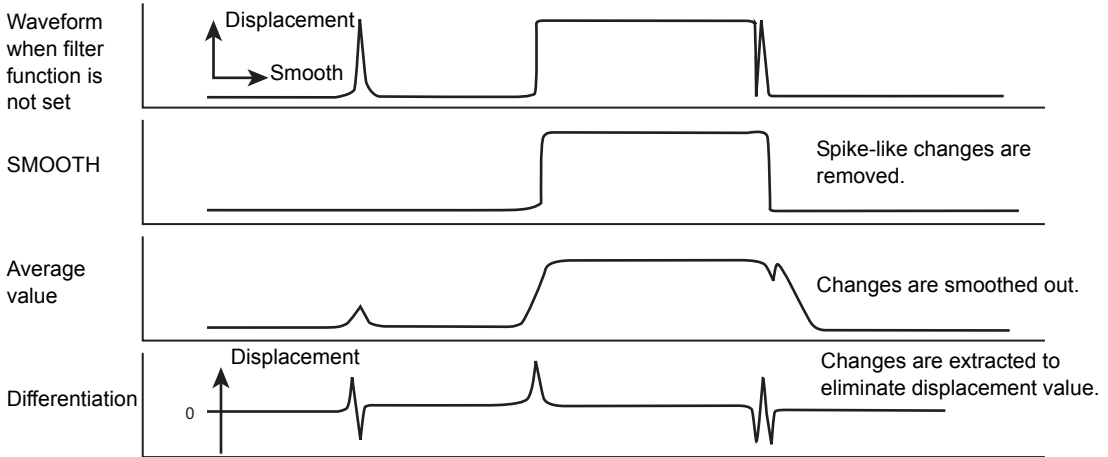

## Setting SMOOTH

The intermediate value of multiple sets of data can be output as the measurement result. This function removes any abnormal values such as spiking that occur when the shape of the workpiece suddenly changes during measurement.

Example: To remove spiking

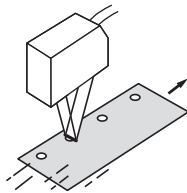

Abnormal values such as spiking that occur when the shape of the workpiece suddenly changes during measurement.

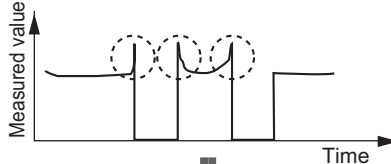

The smoothing function can remove spikes

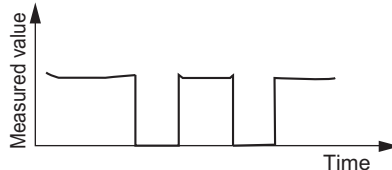

### ► FUN Mode-[FILTER]-[SMOOTH]

Setting	Description
OFF	The smooth function is not used.
ON	The intermediate value of the past 15 measured values is set as the measurement result at each sampling cycle. (default value)



When "HI-SPEED" is set in the measurement mode, [OFF] is set.

## Setting AVERAGE

The average of the measured values obtained based on the preset number of samples can be output. Select this setting when you want to ignore sudden changes in measured values.

### ► FUN Mode-[FILTER]-[AVERAGE]

Setting	Description
1, 2, 4, 8, 16, 32, 64, 128, 256, 512, 1024, 2048, 4096 (When the mode is set to High-Speed mode, the value is from 1 to 256.)	Sets the average count. (default value: 128)

## Setting Differentiation

Use the differentiation function to detect only sudden changes in the measured values that occur during very short periods of time.

The differentiation function detects changes between the present value and the measured value that is in effect just before the comparing pitch. The coefficient of this comparing pitch is defined as the differentiation cycle.

Example: Differentiation cycle=10 ms

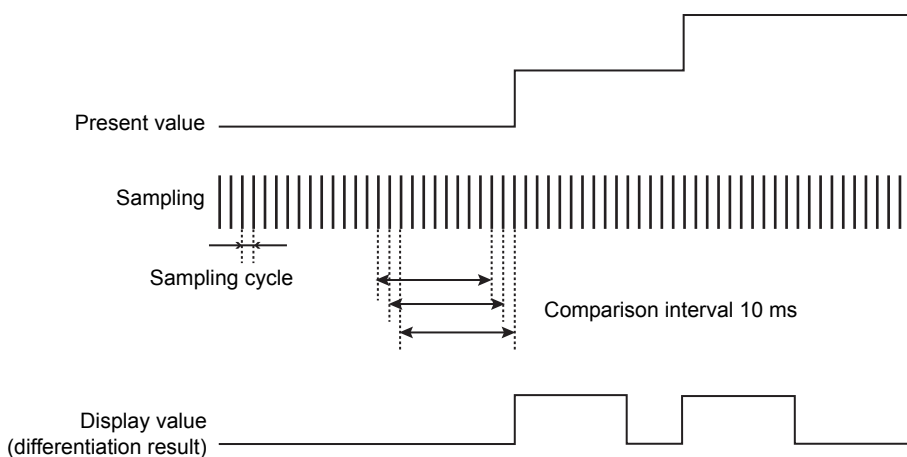

### ► FUN Mode-[FILTER]-[DIFF]

Setting	Description
OFF	The differentiation function is not used. (default value)
ON	Sets the cycle (ms) in which to perform differentiation. Range: 1 to 500

## Setting Output Processing of Sensing Information

Set how sensing information is to be processed for outputting the required values.

### Setting the Scaling

This setting is used when you want to correct any errors that are generated due to the installation status of the Sensor Head, and display the corrected value on the main display. Place an actual sensing object in position for measurement.

There are three setting modes: “manual setting of correction values,” and “one-point scaling” and “two-point scaling” that automatically set the correction values of a placed sensing object.

When GLASS mode is selected for the measurement object, the menu used only for scaling is displayed.



Measuring the Thickness of Transparent Objects p.3-4



The settings listed below return to the default settings when scaling is set. Set these items after scaling settings have been completed.

CHECK!

- Zero reset

#### ■ Setting One-point Scaling

Measurement is performed at one position and offset values are set for that measurement value.

The offset and increment/decrement inversion (display inversion) can be set.

Example: Displaying the height of the sensing object

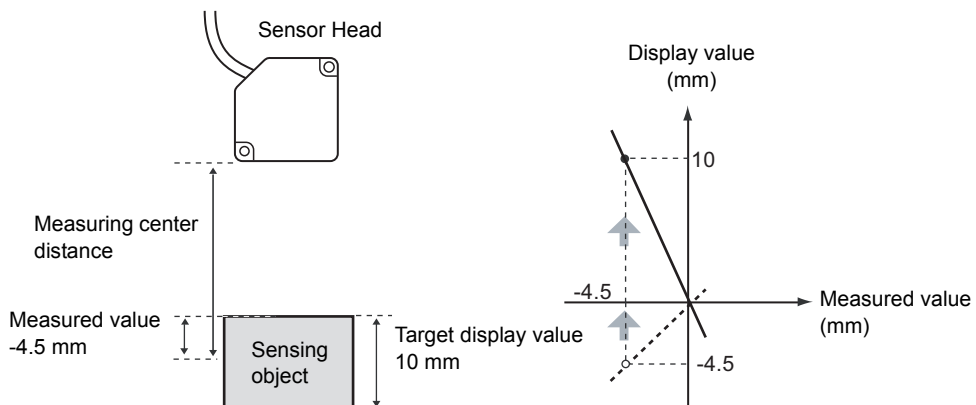



▶ FUN mode-[OUTPUT]-[SCALING]-[ON]-[AUTO]

**1. Set the sensing object in place, and enter the desired setting to be used as the offset.**

The current measured value is displayed on the main display, and the offset value is displayed on the sub-display.

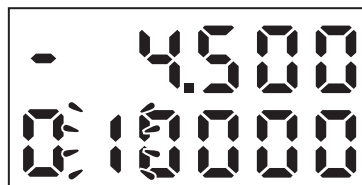

INPUT POINT 1  
←→ DIG ↑ ↓ VAL SET:OK

**2. Press the SET Key to apply the setting.**

**3. Set the decimal point to determine the effective digits.**



The decimal point set here becomes the new decimal point of the scaling setting.  
The position of the decimal point on the display follows the "DOT" setting of the display setup in RUN mode.

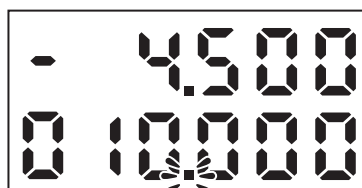

INPUT DOT POINT  
←→ DIG ↑ ↓ VAL SET:OK

**4. Press the SET Key to apply the setting.**

**5. Press the SET key without entering any value for the second point.**

INPUT POINT 2  
←→ DIG ↑ ↓ VAL SET:OK

**6. [Select [FORWARD] or [INVERS].**

CHANGE DIRECTION  
1 FORWARD 2 INVERS



**FORWARD:** The larger the distance between the Sensor Head and the sensing object, the larger the measured value displayed on the Sensor Controller.  
**INVERS :** The larger the distance between the Sensor Head and the sensing object, the smaller the measured value displayed on the Sensor Controller.

## ■ Setting Two-point Scaling

Measurement is performed at two positions and offset values are set for those measured values.

Example: Correcting display values to match actual distances

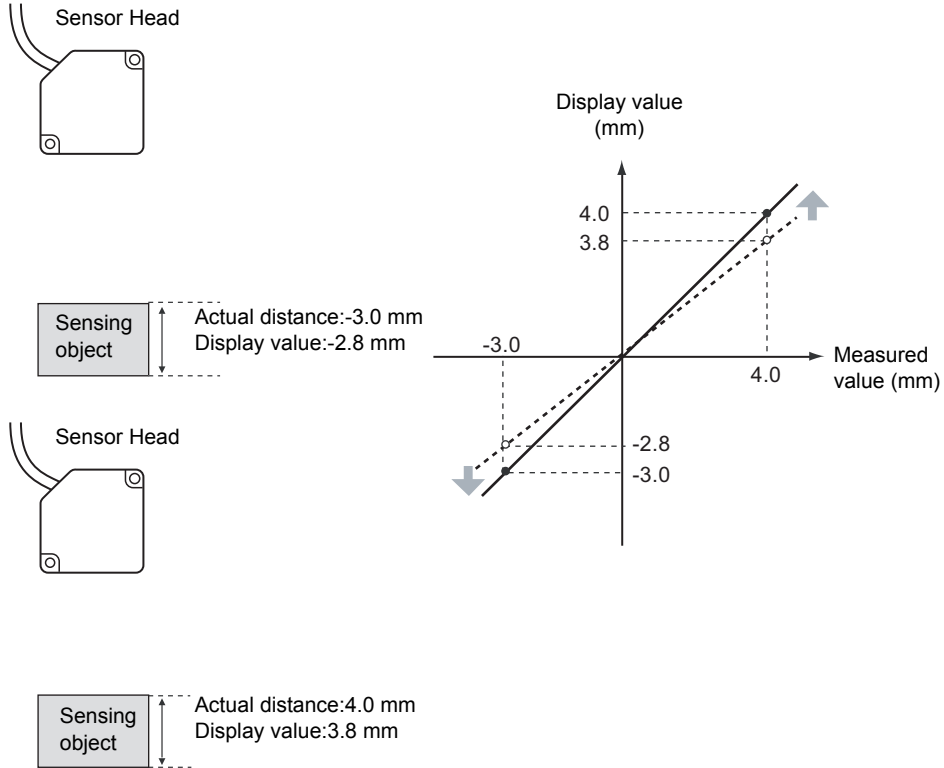

CHECK!

Separate the two specified points by at least 1 % of the rated measurement range for the connected Sensor Head.

Example: For the ZS-LD80 (diffuse reflection type)

The two measured points must be separated by at least "30 mm × 0.01 = 0.3 mm" as the measuring range is "30 mm ± 15 mm".

▶ FUN Mode-[OUTPUT]-[SCALING]-[ON]-[AUTO]

1. Set the first point by following steps 1 to 4 of the one-point scaling procedure.



INPUT POINT 1  
←→ DIG ↑ ↓ VAL SET:OK

2. Place the sensing object at the position (second point) to perform scaling, and enter the desired offset value (second point).  
Press the LEFT key. The sub-display blinks.



INPUT POINT 2  
←→ DIG ↑ ↓ VAL SET:OK

3. Press the SET Key to apply the setting.

## Manual Setting

Enter numerical values for scaling correction values.

▶ FUN Mode-[OUTPUT]-[SCALING]-[ON]-[MANUAL]

Setting	Description
SPAN	<p>Sets the inclination of the sensor characters as a coefficient. Range: -2,0000 to 2,0000</p> <p>The diagram shows a coordinate system with a horizontal axis labeled 'Workpiece displacement' and a vertical axis labeled 'Measurement value (mm)'. A solid line passes through the origin, representing the workpiece displacement. A dashed line also passes through the origin, representing the measurement value. The angle between the solid and dashed lines is indicated by a curved arrow and labeled '2.0' at the top and '-2.0' at the bottom.</p>
OFFSET	<p>Adds/subtracts a fixed value to or from the measured value. Range: -999,999999 to 999,999999</p> <p>The diagram shows a coordinate system with a horizontal axis labeled 'Workpiece displacement' and a vertical axis labeled 'Measurement value (mm)'. A solid line passes through the origin, representing the workpiece displacement. A dashed line is parallel to the solid line, representing the measurement value. A vertical double-headed arrow between the two lines indicates the offset.</p>

## Setting HOLD Functions

Set the hold conditions for measured values. The hold functions hold any value from the measured values during the specific period (sampling period), such as the maximum or minimum value.

### ■ TYPE

Set the hold conditions for measured values.

#### ► FUN Mode-[OUTPUT]-[HOLD]-[TYPE]

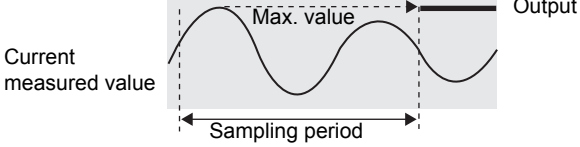
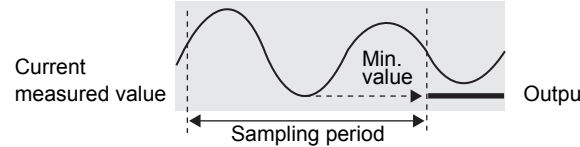
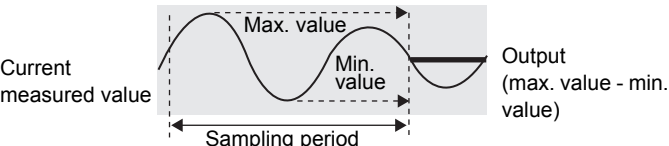
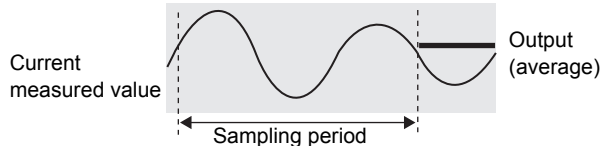
Setting	Description
OFF	Hold measurement is not performed. The measured value is output at all times. (default value)
PEAK	<p>Holds the maximum value during the sampling period. The output changes at the end of the sampling period and is held until the end of the next sampling period.</p> 
BOTTOM	<p>Holds the minimum value during the sampling period. The output changes at the end of the sampling period and is held until the end of the next sampling period.</p> 
P-P	<p>Holds the difference between the maximum and minimum values during the sampling period. This option is selected mainly when detecting vibration. The output changes at the end of the sampling period and is held until the end of the next sampling period.</p> 
AVERAGE	<p>Holds the average measured value during the sampling period. The output changes at the end of the sampling period and is held until the end of the next sampling period.</p> 



Setting	Description
SAMPLE	<p>Holds the measured value at the start of the sampling period. The output changes at the start of the sampling period and is held until the start of the next sampling period.</p> <div style="text-align: center;"> </div>

## ■ Triggers

Set the input method for the timing of the start and end of the measurement period.

### ► FUN mode-[OUTPUT]-[HOLD]-[TRIGGER]

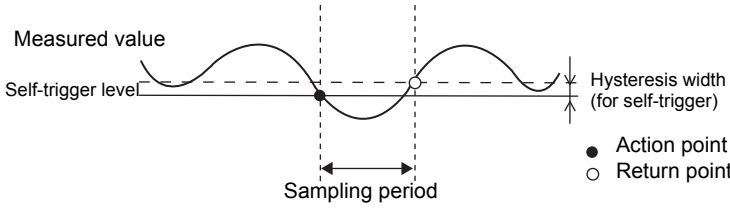
Setting	Description
EXT	<p>Enters the trigger for the start of sampling by using the timing input. The period that the timing signal is ON is the sampling period. (default value)</p> <div style="text-align: center;"> </div> <p> <b>CHECK!</b> When a delay time is set, the input OFF timing and the end of the sampling period will not be synchronous. Sampling will end after the specified sampling period has elapsed.</p>
SELF-UP	<p>The sampling period is the period at which the measured value is greater than the specified self-trigger level. Hold measurement is possible without a sync input.</p> <div style="text-align: center;"> </div> <p><b>● Action point</b> <b>○ Return point</b></p> <p>When SELF-UP is selected, the following items are subsequently displayed:</p> <ul style="list-style-type: none"> <li>• TRG LEVEL Sets the desired self-trigger level. Range: -999,999999 to 999,999999</li> <li>• TRG HYS Sets the hysteresis width for the self-trigger. Range: 0 to 999.999999</li> </ul> <p> <b>CHECK!</b> When a delay time is set, the timing when the measured value becomes smaller than the self-trigger level and the end of the sampling period will not be synchronous. Sampling will end after the specified sampling period has elapsed.</p>

Setting	Description
SELF-DN	<p>The sampling period is the period at which the measured value is smaller than the specified self-trigger level. Hold measurement is possible without a sync input.</p>  <p>When SELF-DN is selected, the following items are subsequently displayed:</p> <ul style="list-style-type: none"> <li>• TRG LEVEL Sets the desired self-trigger level. Range: -999.99 to 999.999</li> <li>• TRG HYS Sets the hysteresis width for the self-trigger. Range: 0 to 999.999</li> </ul> <p> <b>CHECK!</b> When a delay time is set, the timing when the measured value becomes greater than the self-trigger level and the end of the sampling period will not be synchronous. Sampling will end after the specified sampling period has elapsed.</p>



Set the hysteresis width based on the fluctuations in the measured values around the trigger level. The hysteresis will be applied from the start of the sampling period and will prevent timing input chattering.

## ■ DELAY

A delay time is set to ignore measured values immediately after the timing input. This is useful for avoiding bounding during device startup and the influence of machine vibration.

The delay time (the delay between timing input and the start of sampling) and the sampling period can be set.

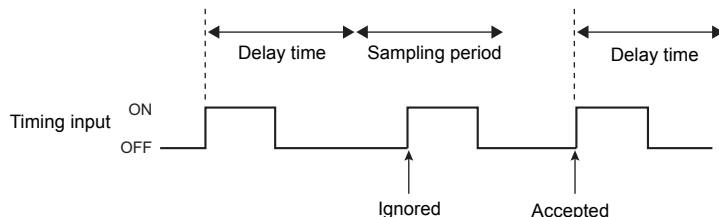

### ▶ FUN mode-[OUTPUT]-[HOLD]-[DELAY]

Setting	Description
OFF	The delay time is not set. (default value)
ON	<p>Sets the delay time. When ON is selected, the following items are subsequently displayed:</p> <ul style="list-style-type: none"> <li>• T-DELAY Sets the delay time. Range: 0 to 9000 (ms)</li> <li>• T-TIME Sets the sampling period. Range: 1 to 9000 (ms)</li> </ul> <p> <b>CHECK!</b> Set so that the “delay time + sampling period” is less than the timing input ON interval. If the next timing input for measurement is received before the “delay time + sampling period” has elapsed, that timing input will be ignored and will not be reflected in the sampling.</p>

## Setting the Zero Reset Function

### ■ TYPE

Set how zero reset is to be executed.

#### ► FUN Mode-[OUTPUT]-[0RESET]-[TYPE]

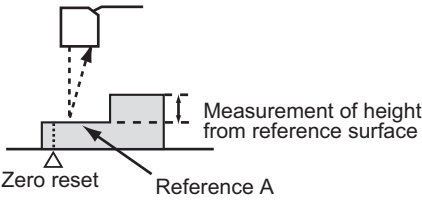
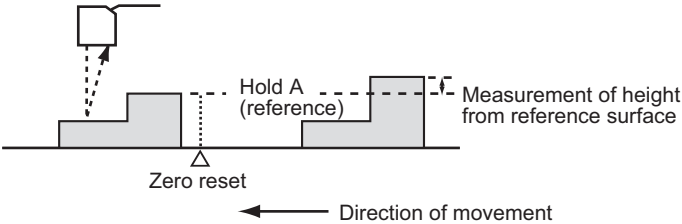
Setting	Description
REAL	<p>Sets the measured value when a zero reset is executed to zero. (default value)</p> 
HOLD	<p>Sets the measured value (hold value) when a zero reset is executed to zero. This setting is enabled when hold measurement is performed.</p> 

### ■ OFFSET

Set an offset to set the reference value for zero reset to a value other than 0.

#### ► FUN mode-[OUTPUT]-[0RESET]-[OFFSET]

Setting	Description
OFFSET	<p>Sets the reference value. Range: -999.999 to 999.999 (default value: 0)</p>

### ■ STATUS

Set valid/invalid for the zero reset function.

#### ► FUN mode-[OUTPUT]-[0RESET]-[STATUS]

Setting	Description
ON	<p>When a zero reset input is received externally, a zero reset is executed. (Default Value)</p>
OFF	<p>Even when a zero reset input is received externally, a zero reset is not executed.</p>



In Multi-Task mode, set ON/OFF for each TASK.

CHECK!



## ■ 0RESET MEMORY

You can select whether or not to hold the measured value zero reset level even if the power is turned OFF.

### ▶ FUN Mode-[SYSTEM]-[0RESET]

Setting	Description
OFF	Zero reset is canceled when the power is turned OFF. (default value)
ON	The zero reset level is saved to memory even if the power is turned OFF.

Turn [OFF] zero reset memory if, as in the example below, the zero point is reset for each measurement.

Example: When the step of the sensing object is measured

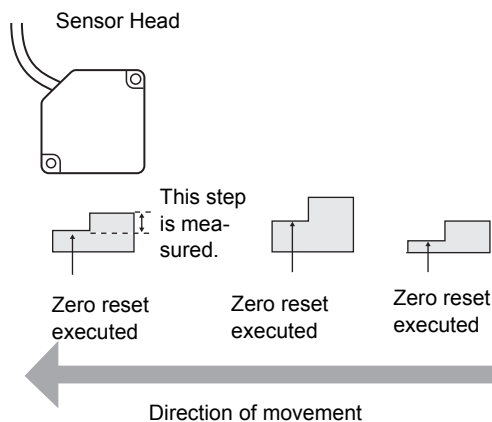

- If zero reset memory is [ON], the zero reset level data will be written in the Sensor Controller non-volatile memory (EEPROM) at each zero reset. The EEPROM can be written a maximum of 100,000 times. Writing the zero reset level for each measurement can, therefore, use up the life of the memory and lead to malfunctions.
- Even if zero reset memory is enabled, the zero reset level will be held also when it is saved. Zero reset will continue after startup when these functions have been changed.

## Setting for Measurement of Characteristic Points

You can measure any measurement points within the range of received light by using the line beam characteristics and multi-task function. Set this menu when you measure subtle concavity and convexity in the workpiece or thickness of a transparent object.

The setting for measuring the characteristic points are valid only in Multi-Task mode.

► FUN Mode-[MEASURE]-[Measured value]

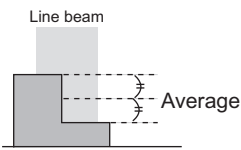
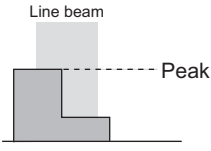
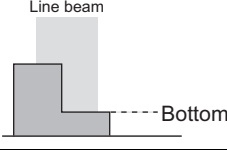
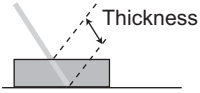
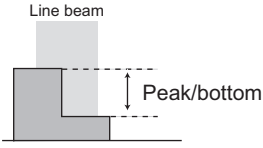
Setting	Description	
NONE	Does not set measurement points.	
AVERAGE	Measures the average position between the peak and bottom positions of the line beam. You can measure the distance from the workpiece. (default value)	
PEAK	Measures the peak position of the line beam. You can measure the highest position in the line beam.	
BOTTOM	Measures the bottom position of the line beam. You can measure the lowest position in the line beam.	
THICK	Measures the thickness of a transparent object such as glass.	
STEP	Measures between peak and bottom in the line beam. You can detect subtle concavity and convexity in the workpiece.	
K+mX+nY(calculation)	Select this to perform logic operations on X and Y with the coefficient freely set. In addition, you can assign, to TASK, the measurement of characteristic points you have set, and measure multiple points or perform calculations. <ul style="list-style-type: none"> <li>• K range: -999999 to 999999</li> <li>• m range: -10.0 to 10.0</li> <li>• n range: -10.0 to 10.0</li> <li>• X range: NONE, TASK1 to TASK4</li> <li>• Y range: NONE, TASK1 to TASK4</li> </ul>	

## Setting Display Method

Set what you want to display on the Sensor Controller during measurement in RUN mode. To set the display method, switch to RUN mode and display the top menu.

### Setting the Digital Display

Set what is displayed on the display in RUN mode.

#### ■ Number of digits past the decimal point

Set the number of display digits in the main display and sub-display.

When five or less digits are set, the digits are disabled from the rightmost digit first.

▶ RUN Mode-MENU key-[DIGITAL]-[DOT]

Setting	Description
5th, 4th, 3rd, 2nd, 1st, 0	Sets the number of display digits past the decimal point. (default value: varies depending on the connected Sensor Controller.)

#### ■ Setting the ECO display

Set the brightness of the main display and sub-displays.

▶ RUN Mode-MENU key-[DIGITAL]-[ECO]

Setting	Description
NORMAL	Sets the display to normal brightness. (default value)
ECO	Suppresses the brightness by reducing current consumption to darken the display.
OFF	Turns the display OFF.

### Displaying HELP

Display Help for the functions assigned to the SET or ESC keys in RUN mode.

▶ RUN Mode-MENU Key-[HELP]

## Setting the LCD Screen

Set how the LCD screen is displayed in RUN mode.

### ■ Setting display ON/OFF

Set whether or not to display the LCD screen.

▶ RUN Mode-MENU key-[LCD]-[ON/OFF]

Setting	Description
ON	Displays the LCD screen at all times. (default value)
AUTOOFF	Turns the LCD screen display OFF when no operations are performed for one minute.
OFF	Turns the LCD screen OFF. (This setting is valid only in RUN mode. Note, however, that pressing the MENU key displays the display customize menu.)

### ■ Setting the backlight ON/OFF

Set whether or not to turn the LCD screen's backlight ON or OFF.

▶ RUN Mode-MENU key-[LCD]-[B.LIGHT]

Setting	Description
ON	Turns the LCD screen backlight ON at all times. (default value)
AUTOOFF	Turns the backlight OFF when no operations are performed for one minute.
OFF	Turns the LCD screen backlight OFF.

### ■ Customizing the LCD display

Set this item to display customized characters on the LCD screen.

▶ RUN Mode-MENU key-[LCD]-[CUSTOM]

Setting	Description
UPPER	Set this item to ON to display characters set at [U-CUST] on the upper section of the LCD screen. (default: U-OFF)
LOWER	Set this item to ON to display characters set at [L-CUST] on the lower section of the LCD screen. (default: L-OFF)
U-CUSTM	Use this setting to edit characters to display on the LCD screen. (max. 16 digits) Call up the initial character of each character group using function keys 1 to 4. 1: A to Z 2: a to z 3: KANA (Japanese Characters)
L-CUSTM	4. Numbers, ., ;, , <, =, >, ?, @ Switch the characters in order using the UP or DOWN key. Move the digits by the LEFT or RIGHT key. To clear a character, select a space.

## Setting the System Environment

Set the system environment.

### Checking Information

Displays the sampling cycle and version of Sensor Controller system.

#### ► FUN Mode-[SYSTEM]-[INFO]

Setting	Description
CYCLE	Displays the current sampling cycle.
VERSION	Displays the version of the Sensor Controller system.

### Setting the Key Lock

The key lock function disables all Sensor Controller keys. Once the keys have been disabled, no key input will be accepted until the lock is released. This function is useful to prevent inadvertent changes to settings.

Moving to the key lock menu or moving between menu hierarchies by the MENU or ESC keys are possible even when the key lock function is ON.

#### ► FUN Mode-[SYSTEM]-[KEYLOCK]

Setting	Description
OFF	Cancels the key lock function. (default value)
ON	Turns the key lock function ON.

## Setting the Sensor Load Method

Set whether or not to load information from the currently connected Sensor Head when the Sensor Controller is started up.

▶ FUN Mode-[SYSTEM]-[SenINFO]

Setting	Description
LOAD	Reads the data currently saved on the Sensor Head each time that the Sensor Controller is started up. (default value)
SAVE	Data is not read from the Sensor Head when the Sensor Controller is started up if the same Sensor Head at the previous startup is connected.   When the combination of Sensor Controller and Sensor Head is fixed, selecting "SAVE" sometimes results in the Sensor Controller starting up more stably depending on the operating environment. <b>CHECK!</b>

## Setting the Display Language

Set the display language of the LCD screen.

▶ FUN Mode-[SYSTEM]-[LANGUAG]

Setting	Description
Japanese	Displays menus in Japanese. (default value)
English	Displays menus in English.

## Changing the Way of Obtaining Banks

Select the bank contents to be obtained from the settings or judgment value.

▶ FUN Mode-[BANK]-[MODE]

Setting	Description
NORMAL	"[SENSING] [MEASUREMENT POINT] [FILTER] [OUTPUT] [I/O SET] that are set in FUN mode", and "the threshold value that is set in TEACH mode" are regarded as bank data. The number of banks is up to four. (default value)
THRESH	"The threshold value that is set in TEACH mode" is regarded as bank data. The number of banks increases up to 32.

## Saving the Settings Data

Bank settings and system settings are saved internally on the Sensor Controller.



CHECK!

- The settings of all banks are saved regardless of the currently selected bank No.
- After you have made or changed settings, be sure to save the setup data. All settings will be deleted if you turn the power OFF without saving the data. A message prompting you to save data will be displayed if you change a mode without saving data after you have changed settings.

### ► FUN Mode-[SYSTEM]-[SAVE]

Setting	Description
OK	Saves the setup data.
CANCEL	Does not save the setup data.

## Clearing the Settings

### Initializing All Settings

Return all bank settings and system settings to their factory settings.



CHECK!

The settings of all banks and system settings are initialized regardless of the currently selected bank No.

### ► FUN Mode-[SYSTEM]-[INIT]

Setting	Description
OK	Initializes the setup data.
CANCEL	Does not initialize the setup data.

### Clearing Banks

“Clearing” initializes the settings of the currently selected bank.

### FUN Mode-[BANK]-[CLEAR]



CHECK!

Settings in [SYSTEM] and settings displayed in RUN mode are not initialized.

MEMO



# Section6

## I/O

☒ Overview	6-2
I/O Cable	6-2
Terminal Block Output	6-2
☒ Settings for Linear Output	6-3
Assignment of Linear Output	6-3
Setting Focus	6-4
Correcting Linear Output Values	6-5
☒ Settings for Judgment Output	6-7
Operation Settings at Judgment Output	6-7
Assignment of Judgment Output (For Multi-Task)	6-8
☒ Settings for Terminal Block Output	6-9
Real-Time Parallel Output Unit	6-9
Assignment of Terminal Block Output	6-10
Output Format	6-11
Setting Focus	6-13
Setting the Update Cycle	6-14
☒ Settings for Processing when Measurement Cannot be Performed	6-15
☒ When Connecting ZS-MDC and ZS-DSU	6-16
☒ Settings for Input Signal	6-17
Settings for the Active Direction of an Input Signal	6-17
Changing the Assignment of Input Signals	6-17
☒ Timing Charts	6-18

## Overview

By using the I/O cable and terminal block output of the Sensor Controller, you can output the measured value or judgment result to external devices, or input a control signal such as zero reset and LD-OFF from external devices. A predetermined I/O signal is assigned to each signal line for the I/O cable.

### I/O Cable

The I/O cable outputs the measured value or judgment value from the I/O cable of the controller, and inputs a measurement control signal or zero reset signal.

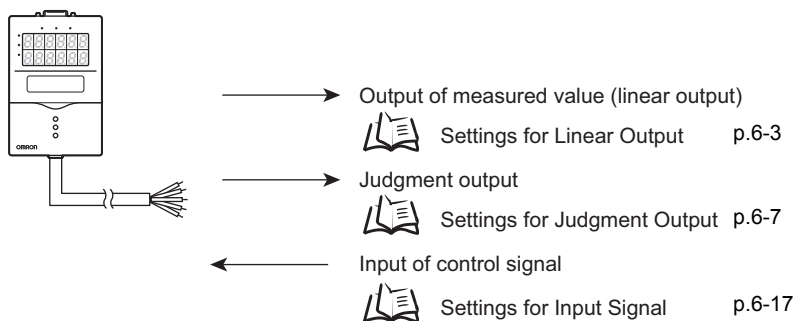

Wiring p.2-10

### Terminal Block Output

When you connect a real-time parallel output unit, the Sensor Controller outputs the measured value or judgment value in parallel.

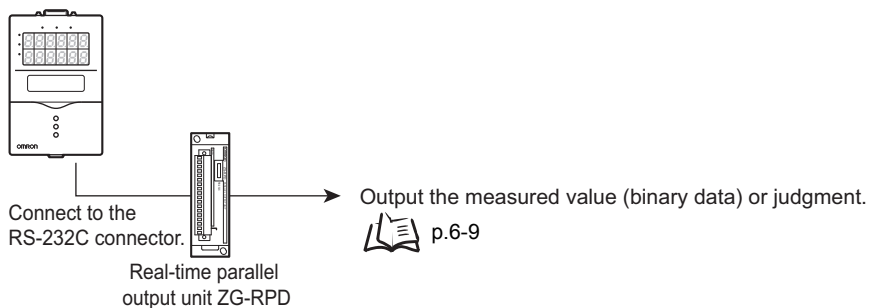

## Settings for Linear Output

This section describes the settings required for linear output of the current measurement result.

### Assignment of Linear Output

Sets the output for the linear output line. Depending on the selected task mode, the setting value differs.

► FUN mode-[I/OSET]-[ANALOG]-[OUT]

• For Single-Task mode

Setting	Description
ON	Linearly outputs the measured value from the controller. (default value)
OFF	Does not output linearly.

• For Multi-Task mode

Setting	Description
TASK1 TASK2 TASK3 TASK4	The measured value of the task selected here is linear-output from the controller. (default value: TASK1)
NONE	Does not output linearly.

## Setting Focus

For the linear output, because the measured value is converted to a current of 4 to 20 mA or a voltage of -10 to +10, and is then output, you can freely set the relationship between the displayed measured value and output value. Match the settings to suit the connected external device.

Enter the output values for any two current values or voltage values to set the output range. (default value: OFF)

▶ Example: Set 0 mm to 4 mA and 5 mm to 20 mA. (for current output)

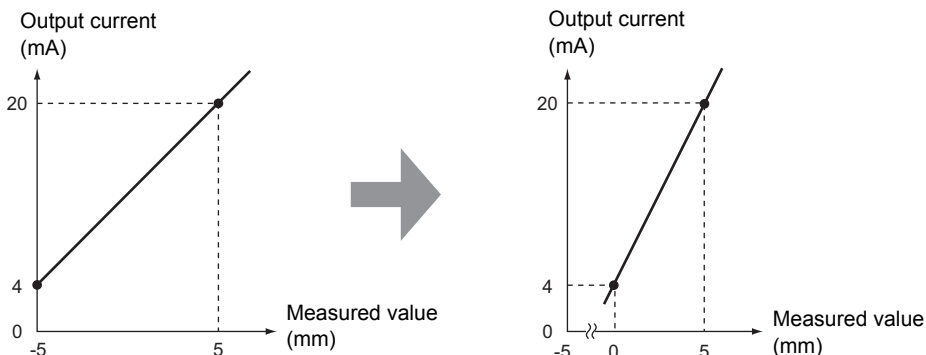

Separate the two specified points by at least 1 % of the rated measurement range for the connected Sensor Head or 40μm or longer.

Example: For the ZS-HLDS5T (diffuse reflection type)

The two measured points must be separated by at least "10 mm × 0.01 = 0.1 mm" as the measuring range is "±5 mm (10 mm)".

▶ FUN mode-[I/O SET]-[ANALOG]-[FOCUS]-[ON]

**1. Set the output value (voltage or current value) of point 1.**

The output value is displayed on the main display.



INPUT POINT 1  
↑ CHANGE SET:OK

**2. Press the SET Key to apply the setting.**

**3. Set the measured value for point 1.**

The measured value is displayed on the sub-display.

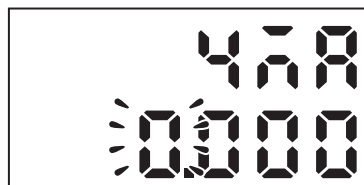

INPUT POINT 1  
← DIG ↑ ↓ VAL SET:OK

**4. Press the SET Key to apply the setting.**

**5. Set point 2 in the same way as point 1.**

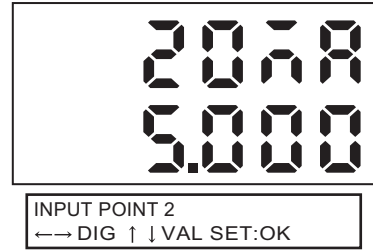

If the points are not set correctly, check the following:

- Is the measured value set on the sub-display within the measuring range (with scaling and calculation settings reflected if set)?
- Are the first and second measured points separated by at least 1 % of the rated measuring range?
- Are the current (or voltage) values for the two points the same?

## Correcting Linear Output Values

Discrepancies may occur between the linear output current (or voltage) values set on the Sensor Controller and the actual current (or voltage) values measured due to the conditions for the connected external device or other factors. The linear output correction function can be used to correct this discrepancy.

The output values are corrected by entering the correction value for the current (or voltage) values for any two points. (default value: OFF)

Range: -999 to 999



Set the focus function and select either current or voltage output beforehand. Also, connect the linear output to an external ammeter or voltmeter.

► FUN mode-[I/O SET]-[ANALOG]-[ADJUST]-[ON]

**1. Set the output value of point 1.**

The output value is displayed on the main display.

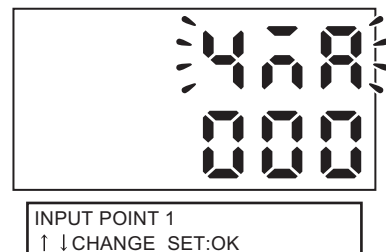

**2. Press the SET Key to apply the setting.**

**3. Set the correction value for point 1.**

The measured value is displayed on the sub-display.

Adjust the correction value on the sub-display so that the measured value of the ammeter (or voltmeter) and the output value shown on the main display are the same.

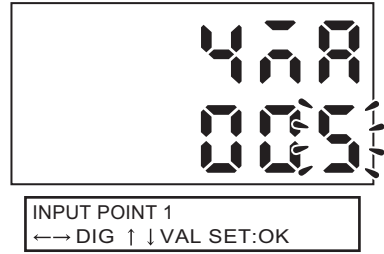

**4. Press the SET Key to apply the setting.**

**5. Set point 2 in the same way as point 1.**



CHECK!

If the points are not set correctly, check to see if the current (or voltage) values of points 1 and 2 are the same.

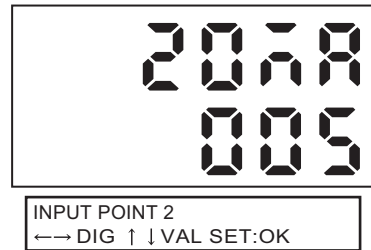

# Settings for Judgment Output

This section describes the settings for outputting the judgment result using the output cable.

## Operation Settings at Judgment Output

Sets the hysteresis width for the upper and lower limits of judgments and the judgment output timing.

 Threshold Setting p.4-7

### ► FUN mode-[I/O SET]-[JUDGE]

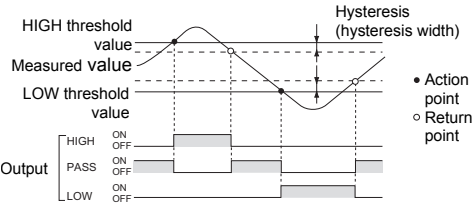
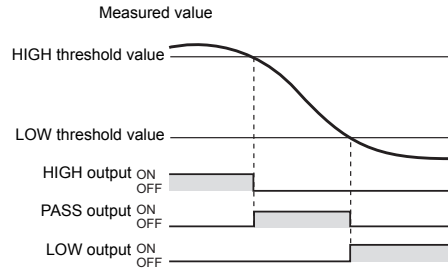
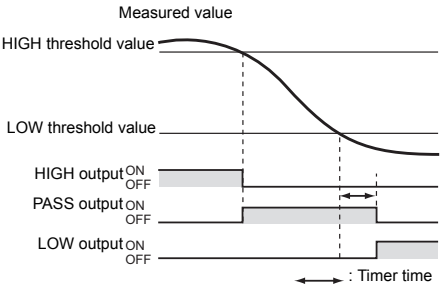
Setting	Description
HYS	<p>Set the hysteresis value for the upper and lower limits of judgments if the HIGH, PASS, or LOW judgment is unstable near the threshold values.</p> <p>Range: 0 to 999.999 (default value: 0.05 % of Sensor Head measuring range) Example: For ZS-LD80, 15 <math>\mu</math>m (0.005 % of 30 mm) as measuring range is <math>\pm</math>15 mm</p>  <p>• Action point ○ Return point</p>
TIMER	<p>Set the timing for judgment outputs to match the operation of external devices.</p>
OFF (default value)	<p>Outputs the judgment as soon as the judgment result has been applied.</p> 
OFF-DLY	<p>After the measurement result has been applied, delays turning OFF the PASS output for the time set to the timer. Also delays turning ON the HIGH and LOW outputs for the time set to the timer.</p> <p>Range: 1 to 5,000 (ms)</p>  <p>: Timer time</p>

Setting	Description
ON-DLY	<p>After the measurement result has been applied, delays turning ON the PASS output for the time set to the timer.</p> <p>Also delays turning OFF the HIGH and LOW outputs for the timer time.</p> <p>Range: 1 to 5,000 (ms)</p>
1 SHOT	<p>When the judgment result changes to PASS, outputs the PASS output for the time set to the timer.</p> <p>Neither the HIGH nor the LOW output is output.</p> <p>Range: 1 to 5,000 (ms)</p>

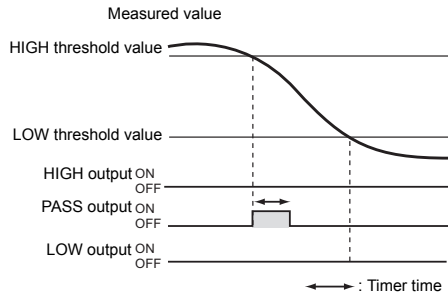
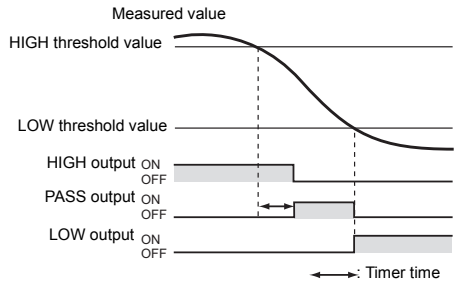

## Assignment of Judgment Output (For Multi-Task)

Sets which TASK to output.

### ► FUN mode-[I/O SET]-[JUDGE]-[OUTPUT]

Setting	Description
TASK1 TASK2 TASK3 TASK4	<p>The selected task result is output to the following output lines. (default value: TASK1)</p> <ul style="list-style-type: none"> <li>• HIGH</li> <li>• PASS</li> <li>• LOW</li> <li>• BUSY</li> </ul>



When you want to output the judgment of multiple tasks together using Multi-Task mode, you need to have a real-time parallel output unit.

CHECK!



Settings for Terminal Block Output p.6-9



## Settings for Terminal Block Output

The following describes the methods for connecting a real-time parallel output unit (ZG-RPD\_1) and outputting the measured value or judgment result at high speed. The measured value is converted to 16-bit binary data in the maximum steps of 65536, and is output.

In Multi-Task mode, you can output all of the judgment results of multiple tasks together.

### Real-Time Parallel Output Unit

#### ■ Connection of a Real-Time Parallel Output Unit

Hang the hook that is on the rear side of the real-time parallel output unit to the DIN track and attach it there. Then, connect the connector of the Sensor Controller to the RS-232C connector of ZS-HLDC\_1, and use the Sensor Controller.

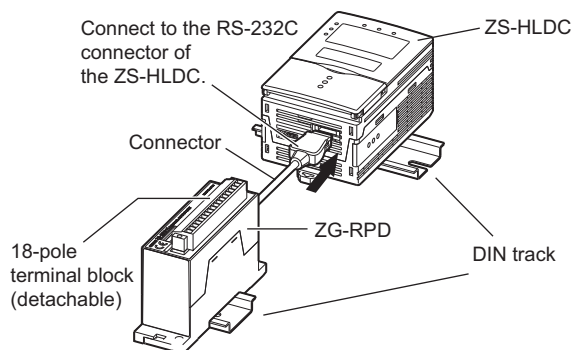

#### ■ Alignment of the Terminal Block

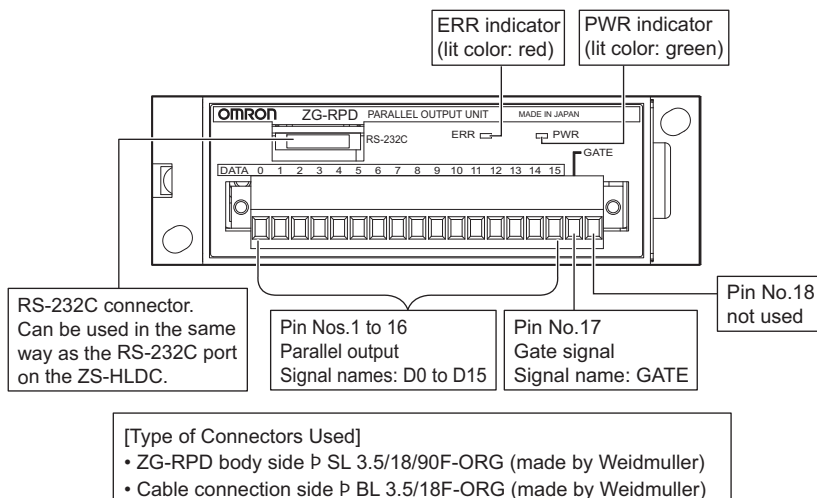

**■ Circuit Specification**

The following circuit configuration is employed for the total of 17 outputs including data output (D0 to D15) and GATE signal.

- ENPN output type (ZG-RPD11)

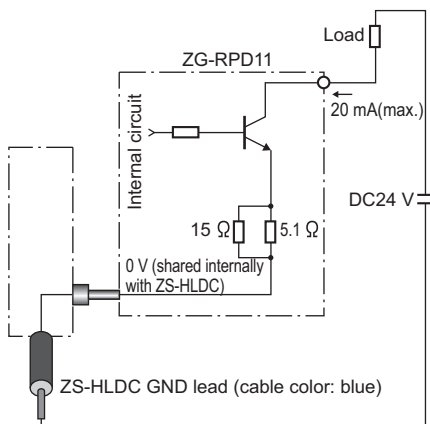

- EPNP output type (ZG-RPD41)

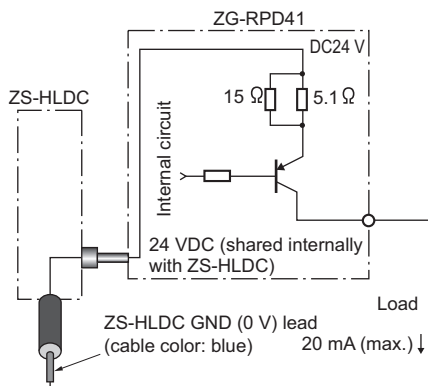

**Assignment of Terminal Block Output**

Sets the output contents for the real-time parallel output unit. Depending on the selected mode, the setting value differs.

- ▶ FUN mode-[I/O SET]-[TERMINAL]-[OUT]

- For Single-Task mode

Setting	Description
NONE	Does not output to the real-time parallel output unit. Compared to the case when the measured value or judgment is output, the sampling cycle becomes short. (Default Value)
MEASURE	Outputs the measured value to the real-time parallel output unit.
JUDGE	Outputs the judgment result to the real-time parallel output unit.

- For Multi-Task mode

Setting	Description	
NONE	Does not output to the real-time parallel output unit. Compared to the case when the measured value or judgment is output, the sampling cycle becomes short. (Default value)	
MEASURE	TASK1	The measured value of the task selected here is output to the real-time parallel output unit.
	TASK2	
	TASK3	
	TASK4	
	REPEAT	Continuously outputs TASK1 to TASK4.
JUDGE	Outputs the judgment result to the real-time parallel output unit.	

## Output Format

### ■ When the measured value is output

The measured value is converted to 16-bit binary data in the maximum steps of 65536, and is output. The following table lists the correspondence between the measured value and 16-bit binary data.

Becomes CLAMP-LV when a measurement error occurs.

		Data output value of parallel data				
		In decimal	16-bit binary data (in binary)			
Measuring range	CLAMP-LV →	65535	1111	1111	1111	1111
	↑ FAR side	52768	1100	1110	0010	0000
		48768	1011	1110	1000	0000
		44768	1010	1110	1110	0000
		40768	1001	1111	0100	0000
		36768	1000	1111	1010	0000
		32769	1000	0000	0000	0001
	CENTER	32768	1000	0000	0000	0000
		32767	0111	1111	1111	1111
		28768	0111	0000	0110	0000
		24768	0110	0000	1100	0000
		20768	0101	0001	0010	0000
		16768	0100	0001	1000	0000
	↓ NEAR side	12768	0011	0001	1110	0000

D15-D12
D11-D8
D7-D4
D3-D0

Data that is output from a 16-bit terminal block

At default, data is output in 40,000 steps from 12,768 to 52,768.

In the above table,

- 1 indicates that the open-collector output is ON (For NPN type, L level, and for PNP type, H level).
- 0 indicates that the open-collector output is OFF (For NPN type, H level, and for PNP type, L level).

#### • When Only a Task is Output

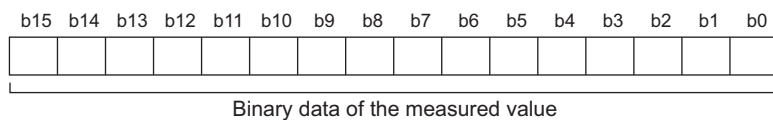

When FOCUS is set, only the measurement that reflects the FOCUS setting is output.

Example: When FOCUS is set for the first point (measured value 0.000 → output value 00000) and second value (measured value 10.000 → output value 20000).

When the measurement result is 5000, 10000 is output in binary.

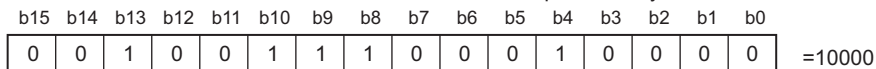

Data output value of parallel data	
Output value after FOCUS is performed (in decimal)	16-bit binary data (in binary)
65535	1111 1111 1111 1111
50000	1100 0011 0101 0000
40000	1001 1100 0100 0000
30000	0111 0101 0011 0000
20000	0100 1110 0010 0000
10000	0010 0111 0001 0000
0	0000 0000 0000 0000

D15-D12
D11-D8
D7-D4
D3-D0

Level that is output from the 16-bit terminal block



## Setting Focus

Enter the measured values for any two binary output values to set the output range. (default value: OFF)

Example: Set 0 mm to 0 and 5 mm to 50000. (when ZS-HLDS5 is connected)

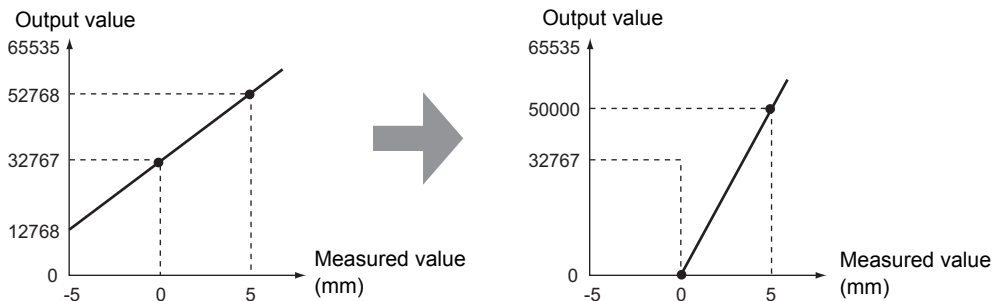

CHECK!

Separate the two specified points by at least 1% of the rated measurement range for the connected Sensor Head.

Example: For the ZS-HLDS5T

The two measured points must be separated by at least " $10 \text{ mm} \times 0.01 = 0.1 \text{ mm}$ " as the measuring range is " $\pm 5 \text{ mm}$  (10 mm)".

► FUN mode-[I/O SET]-[TERMINAL]-[FOCUS]-[ON]

### 1. Set the binary output value of point 1.

The output value is displayed on the main display.

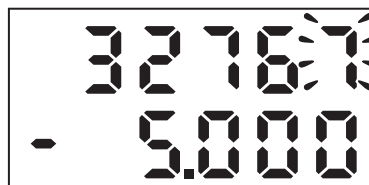

### 2. Press the SET Key to apply the setting.



### 3. Set the measured value for point 1.

The measured value is displayed on the sub-display.

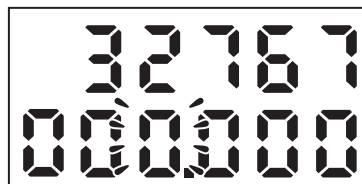

### 4. Press the SET Key to apply the setting.



## 5. Set point 2 in the same way as point 1.



CHECK!

If the points are not set correctly, check the following:

- Is the measured value set on the sub-display within the measuring range (with scaling and calculation settings reflected if set)?
- Are the first and second measured points separated by at least 1 % of the rated measuring range?
- Are the binary output values for the two points the same?

## Setting the Update Cycle

Sets the output cycle for the real-time parallel output unit.

### ► FUN mode-[I/OSET]-[TERMINAL]-[CYCLE]

Setting	Description
1 to 100	<p>Sets the update cycle. (default value: 1) Outputs the measurement result or judgment result for each of "sampling cycle × setting value for the update cycle".</p> <p> Checking the Sampling Cycle p.5-27</p>

## Settings for Processing when Measurement Cannot be Performed

Set the output methods for linear, judge, and terminal block when a non-measurement state occurs temporarily due to insufficient received light amount or the reset input state, for example.

Example: When the waveform skips due to insufficient received light amount

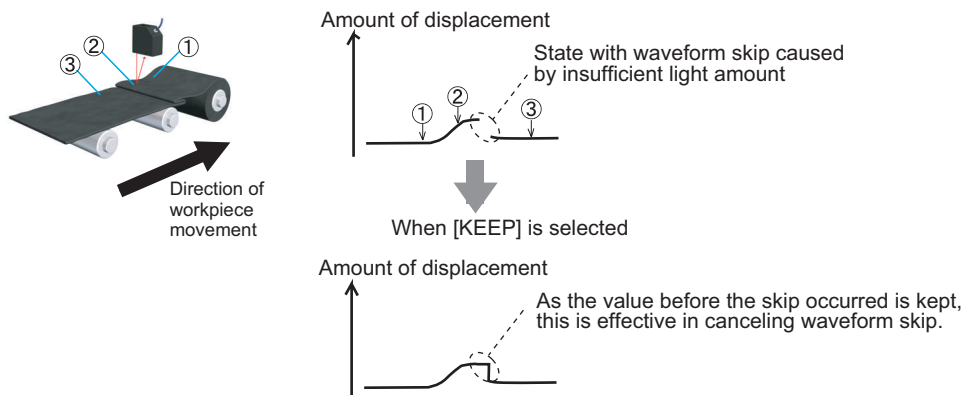

► FUN mode-[I/O SET]-[NO\_MEAS]

Setting	Outputs	
	Linear Output/Terminal Block Output	Judgment Output
KEEP	The status immediately before measurement is stopped is held and output.	
CLAMP (default value)	Outputs the set CLAMP value (abnormal value).	All OFF

In hold measurement, the output before the first hold value is obtained will be the same as [CLAMP] even if [KEEP] is set.  
CHECK!

### ■ Setting the clamp value

If [CLAMP] is selected for the processing when measurement cannot be performed, set the clamp value to be output.

- For linear output

► FUN mode-[I/O SET]-[ANALOG]-[CLAMP]

Setting
When current is output: MIN (approximately 2mA), MAX (approximately 25mA, default value), 4 to 20mA (every 1mA)
When voltage is output: MIN (approximately -11V), MAX (approximately 11V, default value), -10 to 10V (every 1V)

- For terminal block output

► FUN mode-[I/O SET]-[TERMINAL]-[CLAMP]

Setting
0 to 65535 (default value: 65535)

## When Connecting ZS-MDC and ZS-DSU

When you transfer information to ZS-MDC or ZS-DSU, the target to be transferred is only one task. Select the task information to be transferred.

▶ FUN mode-[I/O SET]-[CONNECT]

• For Single-Task mode

Setting	Description
ON	Transfers to the connection target. (default value)
OFF	Does not transfer.

• For Multi-Task mode

Setting	Description
TASK1 TASK2 TASK3 TASK4	Select the task you want to transfer to the connection target.



# Settings for Input Signal

This section describes the settings for controlling by using external input signals.

## Settings for the Active Direction of an Input Signal

Set ON or OFF for an external input signal to an active state for each of the input wires.

### ► FUN mode-[I/O SET]-[INPUT]-[ACTIVE]

Setting	Description	
IN0 to IN3	OFF	The input wire is regarded as active when it is OFF.
	ON	The input wire is regarded as active when it is ON. (default value)

## Changing the Assignment of Input Signals

You can select the function to be assigned to external input signals IN0 to IN3 from two patterns.



CHECK!

- If you use SmartMonitor ZS, you can change the function assignments of IN2 and IN3 if [BANK] is selected. For details, refer to the Help for SmartMonitor ZS.
- These settings are stored in each bank and must be set separately for each bank.

### ► FUN mode-[I/O SET]-[INPUT]-[MODE]

Setting	Description								
NORMAL	Select this to use external input function as in standard applications so far. (default value)								
	<table border="1"> <thead> <tr> <th>IN0</th> <th>IN1</th> <th>IN2</th> <th>IN3</th> </tr> </thead> <tbody> <tr> <td>External trigger (timing) input</td> <td>Reset input</td> <td>LD-OFF input</td> <td>Zero reset input</td> </tr> </tbody> </table>	IN0	IN1	IN2	IN3	External trigger (timing) input	Reset input	LD-OFF input	Zero reset input
	IN0	IN1	IN2	IN3					
External trigger (timing) input	Reset input	LD-OFF input	Zero reset input						
BANK	Select this to switch banks using external inputs.								
	<table border="1"> <thead> <tr> <th>IN0</th> <th>IN1</th> <th>IN2</th> <th>IN3</th> </tr> </thead> <tbody> <tr> <td>Bank input A</td> <td>Bank input B</td> <td>LD-OFF input</td> <td>Zero reset input</td> </tr> </tbody> </table>	IN0	IN1	IN2	IN3	Bank input A	Bank input B	LD-OFF input	Zero reset input
	IN0	IN1	IN2	IN3					
Bank input A	Bank input B	LD-OFF input	Zero reset input						

### • Combination of Banks

With the combination of bank inputs A and B, you can select any banks.

Bank input A	Bank input B	Bank to be Selected
OFF	OFF	BANK1
OFF	ON	BANK2
ON	OFF	BANK3
ON	ON	BANK4



CHECK!

- Bank switching is begun 0.5 seconds after the input state changes.
- At most it takes about 30 seconds to switch banks.
- During bank switching the BUSY output becomes ON.
- If the bank mode is set to [JUDGMENT VALUE], the bank cannot be switched at the external signal input because the number of banks increases to 32.

## Timing Charts

The following shows the timing charts when communication is performed with external devices.

The parts in which specific values are stated in the timing chart are the times that do not depend on the sampling cycle.

### ■ Basic Operation

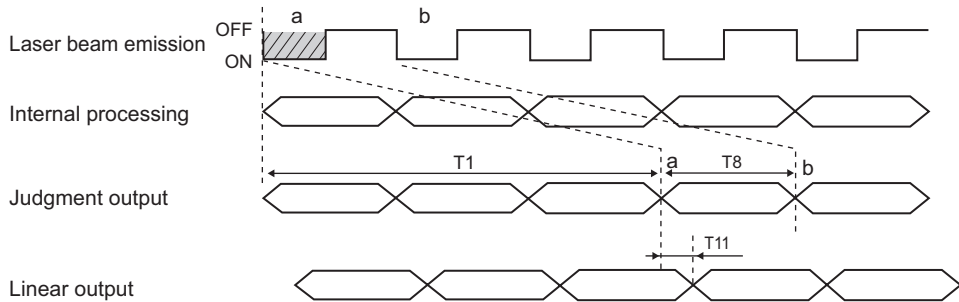

Item		Minimum	Average	Maximum	Remarks
T1	Time during which the measured value is determined from the laser beam emission	—	—	Sampling cycle × 3	When the measurement is performed continuously and the amount of light is stable
T8	Update cycle of judgment output	Sampling cycle			
T11	Response time of linear output	—	—	500 μs	It changes depending on the way the measured value fluctuates.

■ NORMAL

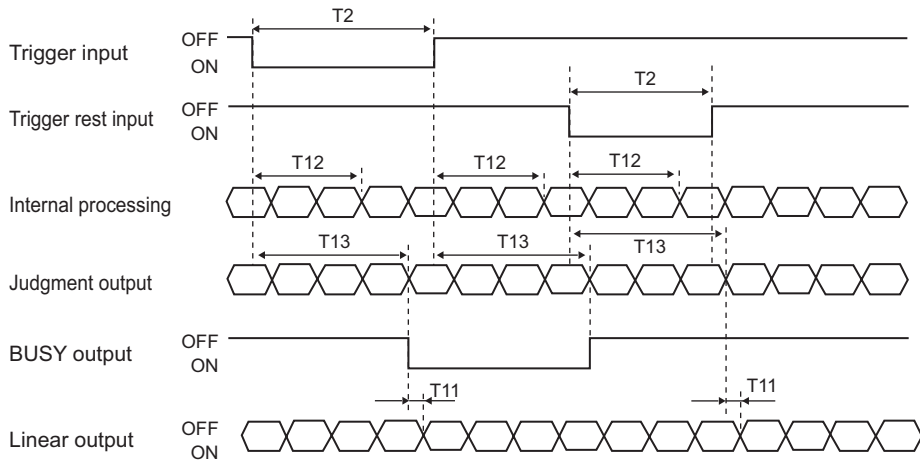

	Item	Minimum	Average	Maximum	Remarks
T2	Minimum time of trigger input	Sampling cycle $\times$ 4	—	—	
T11	Response time of linear output	—	—	500 $\mu$ s	It changes depending on the way the measured value fluctuates.
T12	Timing of starting and ending the measurement after trigger input	Sampling cycle $\times$ 3	—	Sampling cycle $\times$ 4	
T13	Response time of judgment output and BUSY output	Sampling cycle $\times$ 4	—	Sampling cycle $\times$ 5	

■ **Sample Hold**

This is the timing charts when the trigger mode is external trigger.

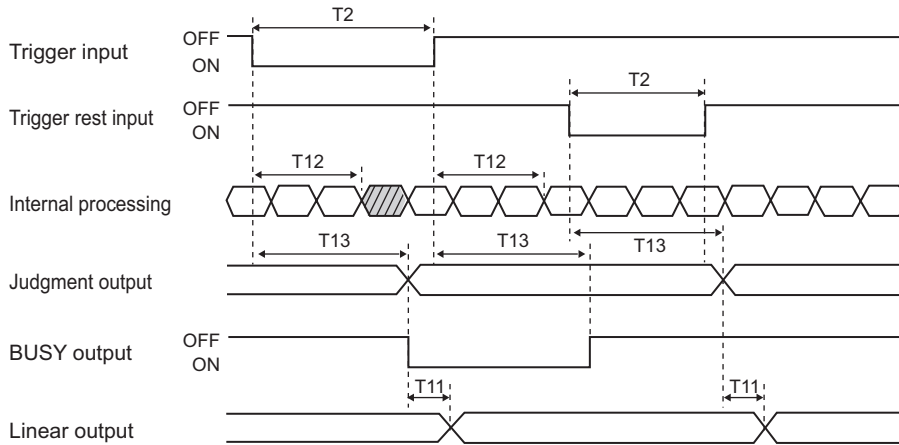

Item		Minimum	Average	Maximum	Remarks
T2	Minimum time of trigger input	Sampling cycle × 4	–	–	
T11	Response time of linear output	–	–	500 μs	It changes depending on the way the measured value fluctuates.
T12	Timing of starting and ending the measurement after trigger input	Sampling cycle × 3	–	Sampling cycle × 4	
T13	Response time of judgment output and BUSY output	Sampling cycle × 4	–	Sampling cycle × 5	

## ■ PEAK/BOTTOM/P-P/AVERAGE HOLD

This is the timing charts when the trigger mode is external trigger.

The result processed at the timing drawn in diagonal line is the target of hold. For the sampling period, see the settings for [HOLD].

 Setting HOLD Functions p.5-18

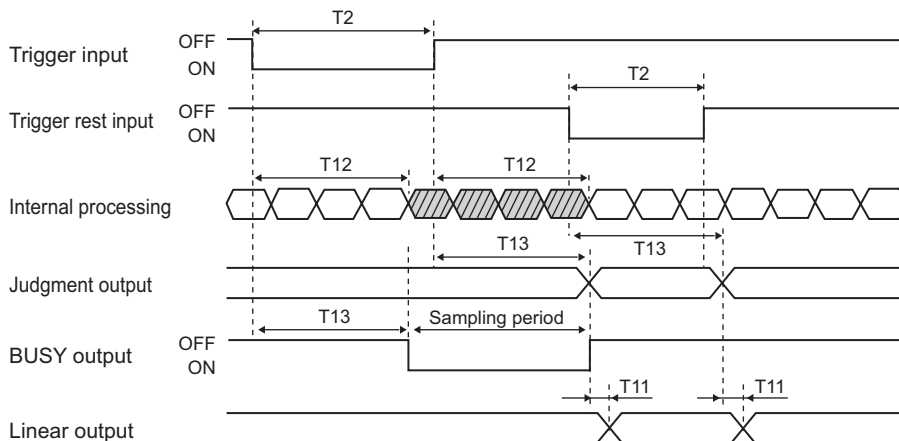

Item		Minimum	Average	Maximum	Remarks
T2	Minimum time of trigger input	Sampling cycle × 4	–	–	
T11	Response time of linear output	–	–	500 μs	It changes depending on the way the measured value fluctuates.
T12	Timing of starting and ending the measurement after trigger input	Sampling cycle × 3	–	Sampling cycle × 4	
T13	Response time of judgment output, BUSY output	Sampling cycle × 4	–	Sampling cycle × 5	

**■ Bank Switching**

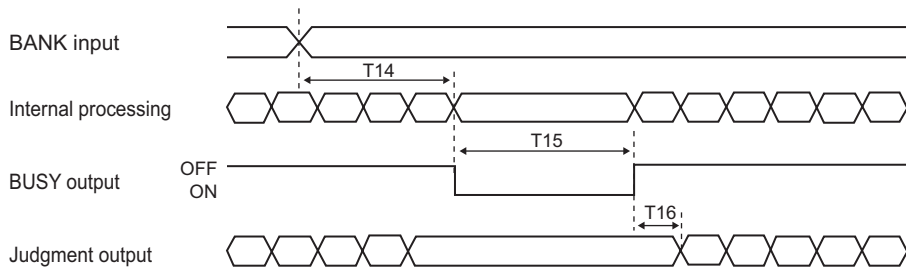

Item	Minimum	Average	Maximum	Remarks	
T14	Time of receiving bank switching input	Sampling cycle × 3	–	Sampling cycle × 4	
T15	Bank switching time	It changes according to the measurement conditions (*1) as follows: • When the parameters from (1) to (3) are the same between BANKS: Within 1s • When the parameter of (1) is in a mode other than High-Speed mode and the parameter of (3) is the same between BANKS: Within 3s • Other cases: Within 15s (*1) Measurement conditions (1) Measurement mode (STAND/HI-SPEED/HI-RESO/HI-SENS/CUSTOM) (2) Scaling (3) Sensor installation (Regular reflection/diffuse reflection)			
T16	Time after the end of bank switching until the output of valid data	Sampling cycle × average number	–	Sampling cycle × (15 + average number)	Time when the adjustment of light amount is "automatic".

**■ Laser OFF**

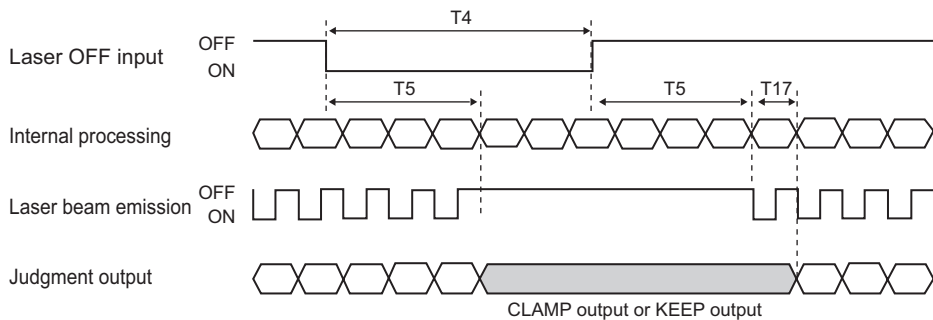

Item	Minimum	Average	Maximum	Remarks	
T4	Time of receiving laser OFF input	500 ms	–	–	
T5	Response time of laser OFF input	–	–	500ms	
T17	Time after the canceling of laser OFF input until the output of valid data	Sampling cycle × average number	–	Sampling cycle × (15 + average number)	It is the time for adjustment of the light amount and average number of buffers.

## ■ Zero Reset

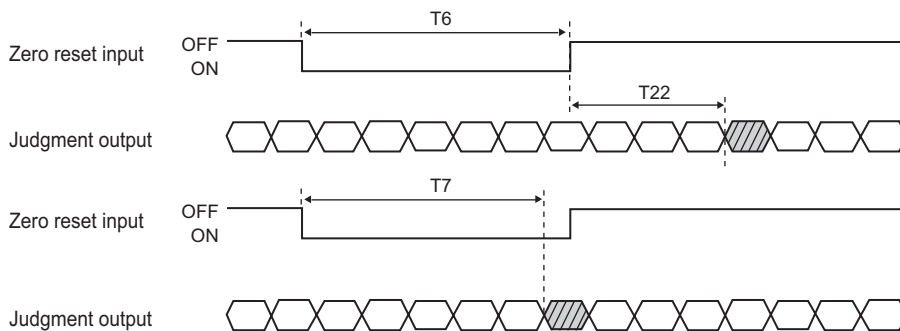

Item		Minimum	Average	Maximum	Remarks
T6	Zero reset input time	50 ms		0.8s	
T7	Cancel time of zero reset input	1s + sampling cycle × 3		1s + sampling cycle × 4	
T22	Time after the input of zero reset until the data output after the zero reset	Sampling cycle × 3		Sampling cycle × 4	

## ■ Operations in FUN Mode and When the Mode is Switched from FUN to One Other Than FUN

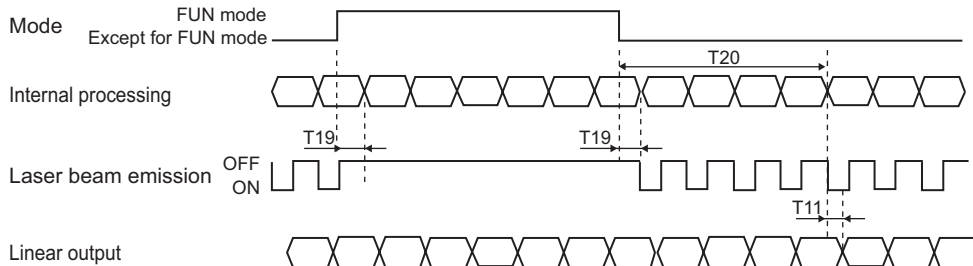

Item		Minimum	Average	Maximum	Remarks
T11	Response time of linear output	–	–	500 μs	It changes depending on the way the measured value fluctuates.
T19	Response time of mode switching	–	–	Sampling cycle	
T20	Determination time of valid data after mode switching	–	–	Sampling cycle × (15 + average number)	



CHECK!

In FUN mode, the value is not output to the terminal block (ZG-RPD/ZS-RPD). Immediately after the mode is switched to one other than FUN mode, a clamp value is output until the measured value is determined.

## ■ Terminal Block (ZG-RPD)

### ● When Judgment and Measured Values of TASK1/2/3/4 are Output

The result of terminal block output is obtained at the falling edge of GATE signal.

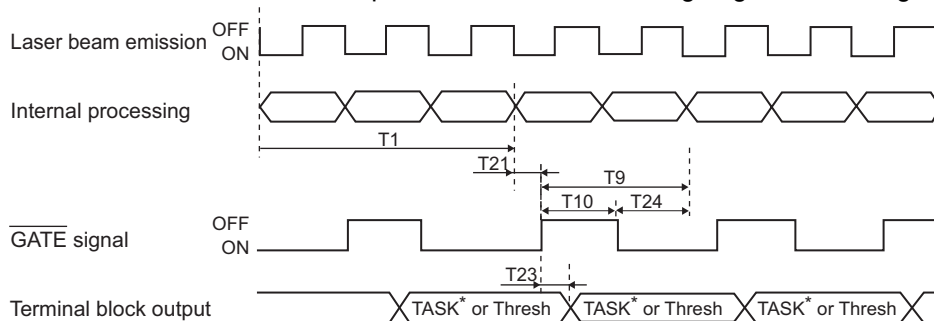

Item		Minimum	Average	Maximum	Remarks
T1	Time during which the measured value is determined from the laser beam emission	—	—	Sampling cycle × 3	The update cycle can be set in [I/OSET]-[TERMINAL BLOCK]-[CYCLE].
T9	Update cycle of terminal block output	Sampling cycle × update cycle			
T10	OFF time of GATE signal	The half of update cycle of terminal block output(T9) However, it will be fixed 140 ms if the terminal block output period (T9) is more than 280 ms.			When the measurement is performed continuously and the amount of light is stable
T21	Response time of GATE signal	320 μs			
T23	The data after Gate signal OFF Hold time	About 48 μs			
T24	ON time of GATE signal	Update cycle of terminal block output(T9)-OFF time of GATE signal(T10)			



● When Measured Value of Tasks are Output Continuously

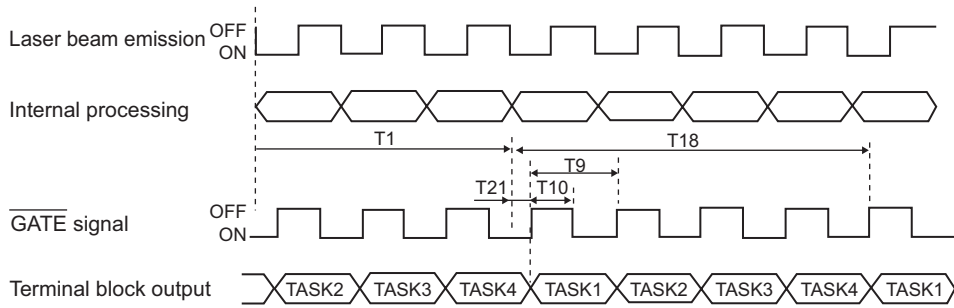

Item		Minimum	Average	Maximum	Remarks
T1	Time during which the measured value is determined from the laser beam emission	-	-	Sampling cycle × 3	The update cycle can be set in [I/OSET]-[TERMINAL BLOCK]-[CYCLE].
T9	Update cycle of terminal block output	Sampling cycle × update cycle			
T10	OFF time of GATE signal	The half of update cycle of terminal block output(T9) However, it will be fixed 140 ms if the terminal block output period (T9) is more than 280 ms.			When the measurement is performed continuously and the amount of light is stable
T18	Update cycle of terminal block output 2	Sampling cycle × update cycle × (number of TASKs that have been performed)			
T21	Response time of GATE signal	320 μs			
T23	The data after Gate signal OFF Hold time	About 48 μs			

**■ Terminal Block (ZS-RPD)**

● **When Judgment and Measured Values of TASK1/2/3/4 are Output**

The result of terminal block output is obtained at the falling edge of GATE signal.

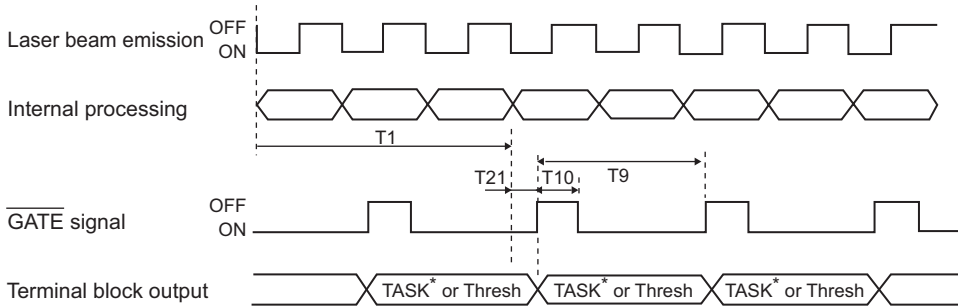

Item		Minimum	Average	Maximum	Remarks
T1	Time during which the measured value is determined from the laser beam emission	-	-	Sampling cycle × 3	The update cycle can be set in [I/OSET]-[TERMINAL BLOCK]-[CYCLE].
T9	Update cycle of terminal block output	Sampling cycle × update cycle			
T10	OFF time of GATE signal	68 μs			When the measurement is performed continuously and the amount of light is stable
T21	Response time of GATE signal	320 μs			

● **When Measured Value of Tasks are Output Continuously**

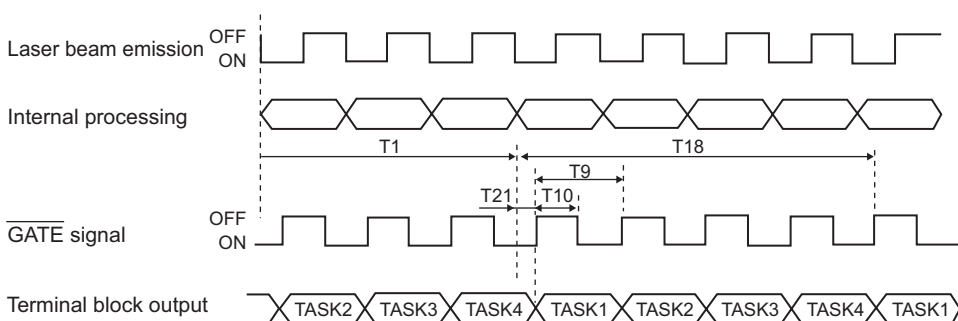

Item		Minimum	Average	Maximum	Remarks
T1	Time during which the measured value is determined from the laser beam emission	-	-	Sampling cycle × 3	The update cycle can be set in [I/OSET]-[TERMINAL BLOCK]-[CYCLE].
T9	Update cycle of terminal block output	Sampling cycle × update cycle			
T10	OFF time of GATE signal	68 μs			When the measurement is performed continuously and the amount of light is stable
T18	Update cycle of terminal block output 2	Sampling cycle × update cycle × (number of TASKs that have been performed)			
T21	Response time of GATE signal	320 μs			

# Section7

## USB/RS-232C COMMUNICATION

☒ Overview	7-2
USB	7-2
RS-232C	7-3
☒ Connecting Using a USB Cable	7-4
Connection Method	7-4
Setting the Communication Specifications	7-4
☒ Connecting Using a RS-232C Cable	7-5
Connection Method	7-5
Setting the Communication Specifications	7-6
☒ Settings for High-Speed Digital Output	7-7
☒ Timing Charts	7-8

# Overview

Using the USB port or RS-232C connector of the Sensor Controller, you can communicate digitally with external devices such as a personal computer or programmable controller. Compared to linear output, you can obtain high resolution, highly stable measurement data.

Communication with external devices using USB or RS-232C is performed in RUN or TEACH mode. Communication cannot be performed in FUN mode. Also, when a system error occurs, the Sensor Controller receives a command externally, but does not execute the setting commands.



CHECK!

Do not perform serial communication during booting up the Sensor Controller.

After output signal ENABLE is ON, start the serial communication.

If you perform serial communication with the Sensor Controller during booting up, it occurs the unexpected operation.

## USB

The Sensor Controller can be connected to a personal computer, and the settings can be changed from the personal computer using SmartMonitor ZS. In addition, the measurement can be monitored on the personal computer.

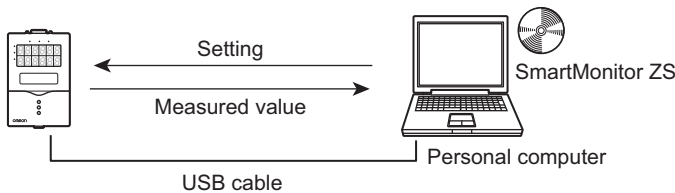

Also, communication can be performed using non-procedural or CompoWay/F commands.

The protocol is selected automatically, and then the Sensor Controller operates in accordance with a input command format.

For details on formats for non-procedural and CompoWay/F commands, refer to the "Communication Command Reference" (provided separately).

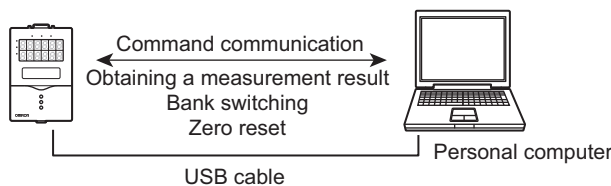

Settings for USB Connection p.7-4

## RS-232C

Connections to the programmable controller, programmable terminal, and personal computer can be made.

Communication can be performed using non-procedural or CompoWay/F commands.

The protocol is selected automatically, and then the Sensor Controller operates in accordance with a input command format.

For details on formats for non-procedural and CompoWay/F commands, refer to the “Communication Command Reference” (provided separately).

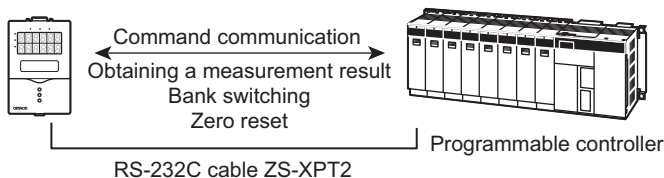

Settings for RS-232C Connection p.7-5



Two lines from the USB port and RS-232C connector can be used together for communication. For example, “data confirmation/analysis” and “data collection/control, change of device setup” can be performed simultaneously.

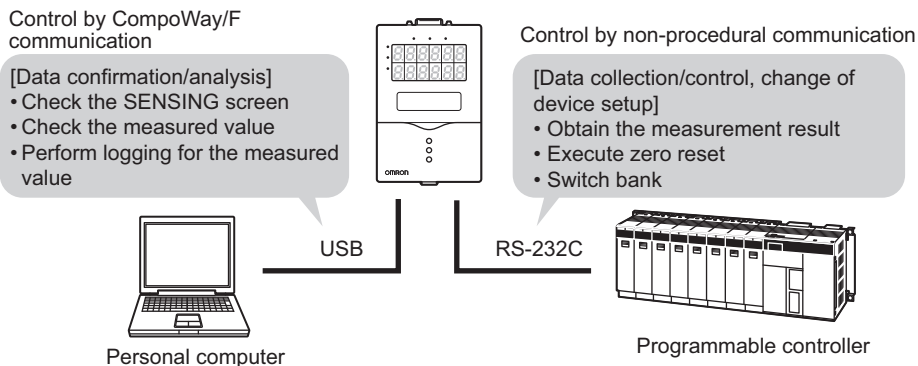

Note that there are restrictions as described below for communication in which two lines are used together.

- The command entered first becomes valid, and the command entered next is executed after processing of the first command ends.
- There are restrictions for commands that are allowed to be entered simultaneously from RS-232C and USB. For details, refer to the “Communication Command Reference” (provided separately).

# Connecting Using a USB Cable

## Connection Method

1. Install the USB driver to a personal computer.  
Installation is required only when USB is connected for the first time.

 Installing the USB driver p.2-16

2. Insert one end of the USB cable into the USB connector of the controller.

3. Insert one end of the USB cable into the USB connector of the external device.

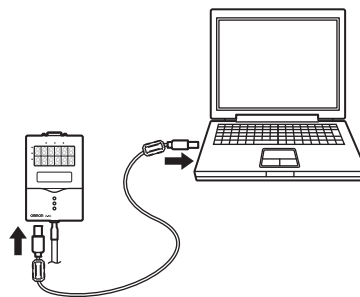

 The USB cable is an accessory of the Sensor Controller ZS-HLDC\_1A. Attach ferrite cores to both ends of the cable.

CHECK!

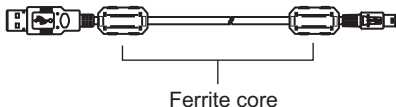

## Setting the Communication Specifications

Set the communication specifications for the controller according to the communication specifications for external devices.

### ► FUN Mode-[SYSTEM]-[COM]

Setting		Range
RS-232C	LENGTH	The settings are ignored.
	PARITY	
	STOP (STOP BIT)	
	BAUDRAT	
	DELIMIT	
NODE (node No.)		The settings are ignored.

# Connecting Using a RS-232C Cable

## Connection Method

1. Insert one end of the RS-232C cable into the RS-232C connector of the controller.
2. Insert one end of the RS-232C cable into the RS-232C connector of the external device.

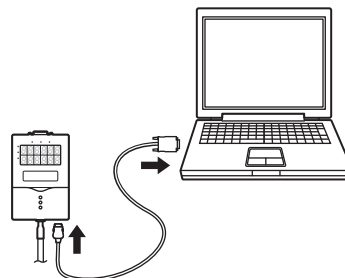

### ■ RS-232C Cable for Connecting to Programmable Controller/ Programmable Terminal

- ZS-XPT2 (cable length: 2 m)

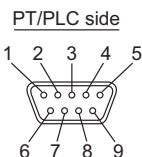
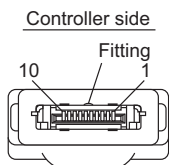
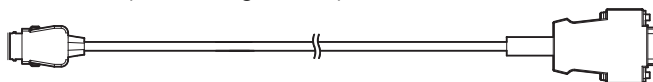

Signal name	Pin No.
NC	1
SD(TXD)	2
RD(RXD)	3
RS(RTS)	4
CS(CTS)	5
NC	6
NC	7
NC	8
SG(GND)	9
NC	10
FG	Shell

Pin No.	Signal name
1	NC
2	SD(TXD)
3	RD(RXD)
4	RS(RTS)
5	CS(CTS)
6	NC
7	NC
8	NC
9	SG(GND)
Shell	FG

Note 1: Plug type connector

**■ RS-232C Cable for Connecting to a Personal Computer**

- ZS-XRS2 (cable length: 2 m)

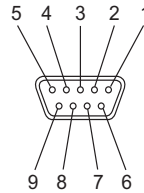
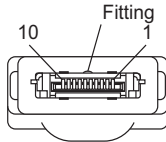
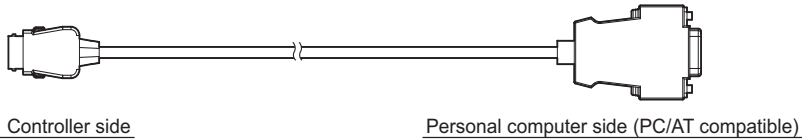

Signal name	Pin No.
NC	1
SD(TXD)	2
RD(RXD)	3
RS(RTS)	4
CS(CTS)	5
NC	6
NC	7
NC	8
SG(GND)	9
NC	10

Pin No.	Signal name
1	NC
2	RD(RXD)
3	SD(TXD)
4	NC
5	SG(GND)
6	NC
7	RS(RTS)
8	CS(CTS)
9	NC

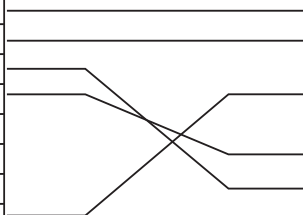

Note: Socket-type connector

**Setting the Communication Specifications**

Set the communication specifications for the controller according to the communication specifications for external devices.

► FUN Mode-[SYSTEM]-[COM]

Setting		Range
RS-232C	LENGTH	8 BIT, 7 BIT (default value: 8 BIT)
	PARITY	NONE, ODD, EVEN (default value: NONE)
	STOP (STOP BIT)	1 BIT, 2 BIT (default value: 1 BIT)
	BAUDRAT	9600, 19200, 38400, 57600, 115200 (default value: 38400)
	DELIMIT	CR, LF, CR+LF (default: CR)
NODE (node No.)		0 to 16  The node No. refers to the connection group No. as seen from the host device (PLC). Not only the ZS Series but other multiple devices are connected to the PLC. The No. assigned to devices connected to a PLC such as this is referred to as a node No. CHECK!



For details on communication commands, refer to the "Communication Command Reference" (provided separately).

For the Communication Command Reference, please contact your OMRON representative.



## Settings for High-Speed Digital Output

Of CompoWay I/F or non-procedural communication commands, if you want to use the FlowDATA command to batch acquire data at high speed, set this setting to ON.

Note, however, that in measurement modes ([High] or [Custom]) having a short sampling cycle, the sampling cycle changes according to the setting of this digital output.



- This setting automatically is set to ON when the graph display and logging functions of SmartMonitor ZS are used. For example, if the mode is set to High-Speed mode at this time, the sampling cycle becomes 1.5 times the sampling cycle.
- When a measurement mode other than [High] or [Custom] is selected, this digital output setting does not cause the sampling cycle to change.

### FUN mode-[I/O SET]-[DIGITAL]

Setting	Description
ON (default value)	Of the communication commands, the command (FlowDATA) for high-speed batch acquisition of data is enabled. Set this to ON to batch acquire data at high speed using communication commands. Note, however, that in measurement modes ([High] or [Custom]) having a short sampling cycle, the sampling cycle becomes 1.5 times the sampling cycle when this setting is set to ON.
OFF	Of the communication commands, the command (FlowDATA) for high-speed batch acquisition of data is disabled. When [High] is selected for the measurement mode, this setting automatically turns OFF, and the sampling cycle becomes the fastest sampling cycle.



In Multi-Task mode, set ON/OFF for each TASK.

# Timing Charts

## ■ RS-232C

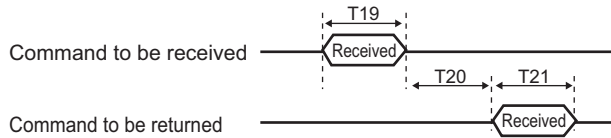

Item		Average		Remarks
T19	Command transmission time	Compoway/F communication	280/communication baud rate	These times change according to the specifications of the communication processing on the personal computer side. You can set the communication baud rate in [SYSTEM]-[COM]-[BAUDRAT]. The Compoway/F communication is for commands for reading and writing parameter areas.
		Non-procedural communication	(number of command characters + 1) × 10/communication baud rate	
T20	Response transmission time	Compoway/F communication	330/communication baud rate	
		Non-procedural communication	(number of response characters + 1) × 10/communication baud rate	

T20 of command processing time changes depending on the command. The following lists the typical non-procedural commands.

Command		Processing Time
Measure-ment-related	MEASURE	Within 10 ms
	DATAGET	Within 10 ms
Setting-related	DATASET	Approximately 500 ms *Changes depending on the settings.

## ■ USB

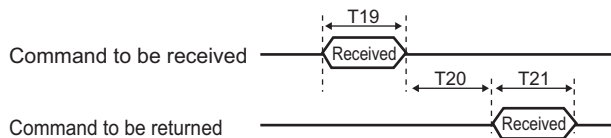

Item		Average		Remarks
T19	Command transmission time	Compoway/F communication	–	These times change according to the specifications of the communication processing on the personal computer side. The communication baud rate depends on the load status of the personal computer; however, it has the capacity value of 7 Mbps on average.
		Non-procedural communication	(number of command characters + 1) × 10/communication baud rate	
T21	Response transmission time	Compoway/F communication	–	
		Non-procedural communication	(number of response characters + 1) × 10/communication baud rate	

T20 of command processing time changes depending on the command. The following lists the typical non-procedural commands.

Command		Processing Time
Measure-ment-related	MEASURE	Within 1 ms (Other than High-Speed mode) Within 3 ms (High-Speed mode)
	DATAGET	Within 5 ms
Setting-related	DATASET	Approximately 500 ms *Changes depending on the settings.

# Section8







## SPECIFICATIONS AND EXTERNAL DIMENSIONS

☒ Sensor Head	8-2
Specifications	8-2
External Dimensions	8-7
Adjusting Mutual Interference	8-14
Spot Diameter	8-18
Usage Width of Line Beam	8-19
Linearity Characteristic by Materials	8-20
☒ Sensor Controller	8-36
Specifications	8-36
External Dimensions	8-38
☒ Accessory	8-39
Panel Mount Adapter	8-39
Extension Cable	8-40
Extension Cable (Long-Distance, Flexible Type)	8-41
RS-232C Cable	8-43
Control Link Unit	8-44
Real-Time Parallel Output Unit	8-45

# Sensor Head

## Specifications

● HLDS2VT/HLDS5T/HLDS10/HLDS60/HLDS150

Item	ZS-HLDS2VT (*5)	ZS-HLDS5T		ZS-HLDS10		ZS-HLDS60	ZS-HLDS150
Optical system	Regular reflection 	Diffuse reflection 	Regular reflection 	Diffuse reflection 	Regular reflection 	Diffuse reflection 	Diffuse reflection 
Measurement center distance	25 mm	50 mm	44 mm	100 mm	94 mm	600 mm	1,500 mm
Measuring range	±2 mm	±5 mm	±4 mm	±20 mm	±16 mm	±350 mm	±500 mm
Light source	Visible semiconductor laser (wavelength 650 nm, 1 mW max., Class 2)						
Beam type	Line beam						
Beam diameter (*1)	45 μm × 2.2 mm	30 μm × 1.0 mm		60 μm × 3.5 mm		0.3 mm × 16 mm (at 500 mm)	1.5 mm × 40 mm (at 1500 mm)
Linearity (*2)	±0.2 %F.S.	±0.1 %F.S.			±0.07 %F.S. (250 mm to 750 mm) ±0.1 %F.S. (750 mm to 950 mm)		±0.2 %F.S.
Resolution (*3)	0.6 μm (average 128)	0.25 μm (average 512)		1 μm (average 64)		8 μm (average 64) (at 250 mm) 40 μm (average 64) (at 600 mm)	500 μm (average 64)
Temperature characteristic (*4)	±0.1 %F.S./°C	±0.01 %F.S./°C					
Sampling cycle	110 μs (High-Speed mode), 500 μs (Standard mode), 2.2 ms (High-Resolution mode), 4.4 ms (High-Sensitivity mode)						
Indicators	NEAR indicator	Lit near the measurement center, and nearer than the measurement center distance inside the measuring range. Flashes when the measurement target is outside of the measuring range or when the received light amount is insufficient.					
	FAR indicator	Lit near the measurement center, and further than the measurement center distance inside the measuring range. Flashes when the measurement target is outside of the measuring range or when the received light amount is insufficient.					
Operating ambient illumination	Illumination on received light surface 3,000 lx or less (incandescent light)					Illumination on received light surface 1,000 lx or less (incandescent light)	Illumination on received light surface 500 lx or less (incandescent light)

Item	ZS-HLDS2VT (*5)	ZS-HLDS5T	ZS-HLDS10	ZS-HLDS60	ZS-HLDS150
Ambient temperature	Operating: 0 to +50 °C, Storage: -15 to +60 °C (with no icing or condensation)				
Ambient humidity	Operating and storage: 35 % to 85 % (with no condensation)				
Degree of protection	IP67 (IEC60529)	When the cable length is 0.5 m: IP66 (IEC60529) When the cable length is 2 m: IP67 (IEC60529)		IP66 (IEC60529)	
Vibration resistance (destructive)	10 to 150 Hz, 0.7 mm double amplitude, 80 min each in X, Y, and Z directions				
Shock resistance (destructive)	150 m/s <sup>2</sup> 3 times each in six directions (up/down, left/right, forward/backward)				
Materials	Case: aluminum die-cast, front cover: glass				
Cable length	0.5 m, 2 m				
Weight	Approx. 350 g	Approx. 600 g		Approx. 800 g	
Accessories	Laser label (1 each for JIS/EN), Ferrite core (2pcs), Insure Lock (2pcs), Instruction Sheet	Laser label (1 each for JIS/EN, 3 for FDA), Ferrite core (4pcs), Insure Lock (2pcs), Instruction Sheet		Laser label (6 for Warning labels, 1 for FDA), Ferrite core (4pcs), Insure Lock (2pcs), Instruction Sheet	

F.S.: Full scale of measurement

(\*1) Defined as  $1/e^2$  (13.5 %) of the center optical intensity in the measurement center distance. The beam diameter is sometimes influenced by the ambient conditions of the workpiece such as leaked light from the main beam.

(\*2) This is the error on the measured value with respect to an ideal straight line. Linear curve may change according to the workpiece. The following lists the workpieces.

Model	Diffusive reflection	Mirror reflection
ZS-HLDS2VT	-	Glass
ZS-HLDS5T	White alumina ceramic	Glass
ZS-HLDS10	White alumina ceramic	
ZS-HLDS60/HLDS150	White alumina ceramic	-







(\*3) This is the “peak-to-peak” displacement conversion value of the displacement output in the measurement center distance when High-Resolution mode and the average number in the table are set (For ZS-HLDS60, the maximum resolution at 250 mm is also included). The following lists the workpieces.

Model	Diffusive reflection	Mirror reflection
ZS-HLDS2VT	-	Glass
ZS-HLDS5T	White alumina ceramic	Glass
ZS-HLDS10	White alumina ceramic	
ZS-HLDS60/HLDS150	White alumina ceramic	-

(\*4) Value obtained when the sensor part and object part are fixed with an aluminum jig. (typical example)

(\*5) Long distance extension of the ZS-HLDS2V Sensor Head (connection to the ZS-XC\_\_CR, ZS-XC02D, ZS-XEQ) is not possible.

● **ZS-LD10GT/LD15GT/LD20T/LD20ST/LD40T**

Item	ZS-LD10GT	ZS-LD15GT	ZS-LD20T		ZS-LD20ST		ZS-LD40T	
	Optical system	Regular reflection 	Regular reflection 	Regular reflection 	Diffuse reflection 	Regular reflection 	Diffuse reflection 	Regular reflection 
Measurement center distance	10 mm	15 mm	20 mm	6.3 mm	20 mm	6.3 mm	40 mm	30 mm
Measuring range	±0.5 mm	±0.75 mm	±1 mm				±2.5 mm	±2 mm
Light source	Visible semiconductor laser (wavelength 650 nm, 1 mW max., Class 2)							
Beam type	Line beam				Spot beam		Line beam	
Beam diameter (*1)	25 × 900 μm		25 × 900 μm		ø 25 μm		35 × 2,000 μm	
Linearity (*2)	±0.1 %F.S.							
Resolution (*3)	0.25 μm						0.4 μm	
Temperature characteristic (*4)	0.04 %F.S./°C						0.02 %F.S./°C	
Sampling cycle	110 μs (High-Speed mode), 500 μs (Standard mode), 2.2 ms (High-Resolution mode), 4.4 ms (High-Sensitivity mode)							
Indicators	NEAR indicator	Lit near the measurement center distance, and nearer than the measurement center distance inside the measuring range. Flashes when the measurement target is outside of the measuring range or when the received light amount is insufficient.						
	FAR indicator	Lit near the measurement center distance, and further than the measurement center distance inside the measuring range. Flashes when the measurement target is outside of the measuring range or when the received light amount is insufficient.						
Operating ambient illumination	Illumination on received light surface 3,000 lx or less (incandescent light)							
Ambient temperature	Operating: 0 to +50 °C, Storage: -15 to +60 °C (with no icing or condensation)							
Ambient humidity	Operating and storage: 35 % to 85 % (with no condensation)							
Degree of protection	IP40 (IEC60529)		Cable length 0.5 m: IP66, cable length 2 m: IP67 (IEC60529)					
Vibration resistance (destructive)	10 to 150 Hz, 0.7 mm double amplitude, 80 min each in X, Y, and Z directions							
Shock resistance (destructive)	150m/s <sup>2</sup> 3 times each in six directions (up/down, left/right, forward/backward)							
Materials	Case: aluminum die-cast, front cover: glass							
Cable length	0.5 m, 2 m							
Weight	Approx. 350 g							
Accessories	Laser label (1 each for JIS/EN), Ferrite core (2pcs), Insure Lock (2pcs), Instruction Sheet		Laser label (1 each for JIS/EN, 3 for FDA), Ferrite core (2pcs), Insure Lock (2pcs), Instruction Sheet					

F.S.: Full scale of measurement

(\*1) Defined as  $1/e^2$  (13.5 %) of the center optical intensity in the measurement center distance. The beam diameter is sometimes influenced by the ambient conditions of the workpiece such as leaked light from the main beam.

(\*2) This is the error on the measured value with respect to an ideal straight line. The standard workpiece is white alumina ceramic (glass in the case of the regular reflection mode). Linearity may change according to the workpiece.

(\*3) This is the "peak-to-peak" displacement conversion value of the displacement output in the measurement center distance when the number of samples to average is set to 128, and the measuring mode is set to High-Resolution mode. The workpiece is white alumina ceramics in the diffuse reflection mode and glass in the regular reflection mode.

(\*4) This is the value obtained in the measurement center distance when the sensor and workpiece are fixed by an aluminum jig. (typical example)

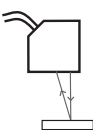
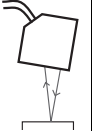
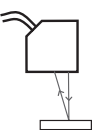
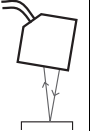
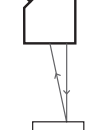
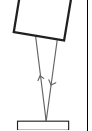
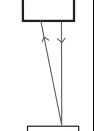
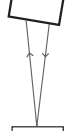

● **ZS-LD50/LD50S/LD80/LD130**

Item	ZS-LD50		ZS-LD50S		ZS-LD80		ZS-LD130		
Optical system	Diffuse reflection 	Regular reflection 	Diffuse reflection 	Regular reflection 	Diffuse reflection 	Regular reflection 	Diffuse reflection 	Regular reflection 	
Measurement center distance	50 mm	47 mm	50 mm	47 mm	80 mm	78 mm	130 mm		
Measuring range	±5 mm	±4 mm	±5 mm	±4 mm	±15 mm	±14 mm	±15 mm	±12 mm	
Light source	Visible semiconductor laser (wavelength 650 nm, 1 mW max., Class 2)								
Beam type	Line beam		Spot beam		Line beam				
Beam diameter (*1)	60 × 900 μm		ø 50 μm		60 × 900 μm		600 × 70 μm		
Linearity (*2)	±0.1 %F.S.							±0.25 %F.S.	
Resolution (*3)	0.8 μm				2 μm		3 μm		
Temperature characteristic (*4)	0.02 %F.S./°C				0.01 %F.S./°C		0.02 %F.S./°C		
Sampling cycle	110 μs (High-Speed mode), 500 μs (Standard mode), 2.2 ms (High-Resolution mode), 4.4 ms (High-Sensitivity mode)								
Indicators	NEAR indicator		Lit near the measurement center distance, and nearer than the measurement center distance inside the measuring range. Flashes when the measurement target is outside of the measuring range or when the received light amount is insufficient.						
	FAR indicator		Lit near the measurement center distance, and further than the measurement center distance inside the measuring range. Flashes when the measurement target is outside of the measuring range or when the received light amount is insufficient.						
Operating ambient illumination	Illumination on received light surface 3,000 lx or less (incandescent light)						Illumination on received light surface 2,000 lx or less (incandescent light)		
Ambient temperature	Operating: 0 to +50 °C, Storage: -15 to +60 °C (with no icing or condensation)								
Ambient humidity	Operating and storage: 35 % to 85 % (with no condensation)								
Degree of protection	Cable length 0.5 m: IP66, cable length 2 m: IP67 (IEC60529)								
Vibration resistance (destructive)	10 to 150 Hz, 0.7 mm double amplitude, 80 min each in X, Y, and Z directions								
Shock resistance (destructive)	150m/s <sup>2</sup> 3 times each in six directions (up/down, left/right, forward/backward)								
Materials	Case: aluminum die-cast, front cover: glass								
Cable length	0.5 m, 2 m								
Weight	Approx. 350 g								
Accessories	Laser label (1 each for JIS/EN, 3 for FDA), Ferrite core (2pcs), Insure Lock (2pcs), Instruction Sheet								

F.S.: Full scale of measurement

- (\*1) Defined as  $1/e^2$  (13.5 %) of the center optical intensity in the measurement center distance. The beam diameter is sometimes influenced by the ambient conditions of the workpiece such as leaked light from the main beam.
- (\*2) This is the error on the measured value with respect to an ideal straight line. The standard workpiece is white alumina ceramic (In the regular reflection mode on ZS-LD50/LD50S, the standard workpiece is glass.) Linearity may change according to the workpiece.
- (\*3) This is the “peak-to-peak” displacement conversion value of the displacement output in the measurement center distance when the number of samples to average is set to 128, and the measuring mode is set to High-Resolution mode. The standard workpiece is white alumina ceramic (In the regular reflection mode on ZS-LD50/LD50S, the standard workpiece is glass).
- (\*4) This is the value obtained in the measurement center distance when the sensor and workpiece are fixed by an aluminum jig. (typical example)

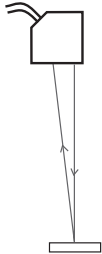
● **ZS-LD200/LD350S**

Item	ZS-LD200		ZS-LD350S
Optical system	Diffuse reflection 	Regular reflection 	Diffuse reflection 
Measurement center distance	200 mm	200 mm	350 mm
Measuring range	±50 mm	±48 mm	±135 mm
Light source	Visible semiconductor laser (wavelength 650 nm, 1 mW max., Class 2)		
Beam type	Line beam		Spot beam
Beam diameter (*1)	100 × 900 μm		∅ 240 μm
Linearity (*2)	±0.1 %F.S.	±0.25 %F.S.	±0.1 %F.S.
Resolution (*3)	5 μm		20 μm
Temperature characteristic (*4)	0.02 %F.S./°C		0.04 %F.S./°C
Sampling cycle	110 μs (High-Speed mode), 500 μs (Standard mode), 2.2 ms (High-Resolution mode), 4.4 ms (High-Sensitivity mode)		
Indicators	NEAR indicator	Lit near the measurement center distance, and nearer than the measurement center distance inside the measuring range. Flashes when the measurement target is outside of the measuring range or when the received light amount is insufficient.	
	FAR indicator	Lit near the measurement center distance, and further than the measurement center distance inside the measuring range. Flashes when the measurement target is outside of the measuring range or when the received light amount is insufficient.	
Operating ambient illumination	Illumination on received light surface 3,000 lx or less (incandescent light)		
Ambient temperature	Operating: 0 to +50 °C, Storage: -15 to +60 °C (with no icing or condensation)		
Ambient humidity	Operating and storage: 35 % to 85 % (with no condensation)		
Degree of protection	Cable length 0.5 m: IP66, cable length 2 m: IP67 (IEC60529)		
Vibration resistance (destructive)	10 to 150 Hz, 0.7 mm double amplitude, 80 min each in X, Y, and Z directions		
Shock resistance (destructive)	150m/s <sup>2</sup> 3 times each in six directions (up/down, left/right, forward/backward)		
Materials	Case: aluminum die-cast, front cover: glass		
Cable length	0.5 m, 2 m		
Weight	Approx. 350 g		
Accessories	Laser label (1 each for JIS/EN, 3 for FDA), Ferrite core (2pcs), Insure Lock (2pcs), Instruction Sheet		

F.S.: Full scale of measurement

- (\*1) Defined as 1/e<sup>2</sup> (13.5 %) of the center optical intensity in the measurement center distance. The beam diameter is sometimes influenced by the ambient conditions of the workpiece such as leaked light from the main beam.
- (\*2) This is the error on the measured value with respect to an ideal straight line. The standard workpiece is white alumina ceramic. Linearity may change according to the workpiece.
- (\*3) This is the “peak-to-peak” displacement conversion value of the displacement output in the measurement center distance when the number of samples to average is set to 128, and the measuring mode is set to the High-Resolution mode. The standard workpiece is white alumina ceramic.
- (\*4) This is the value obtained in the measurement center distance when the sensor and workpiece are fixed by an aluminum jig. (typical example)



## External Dimensions

### ● ZS-HLDS2VT

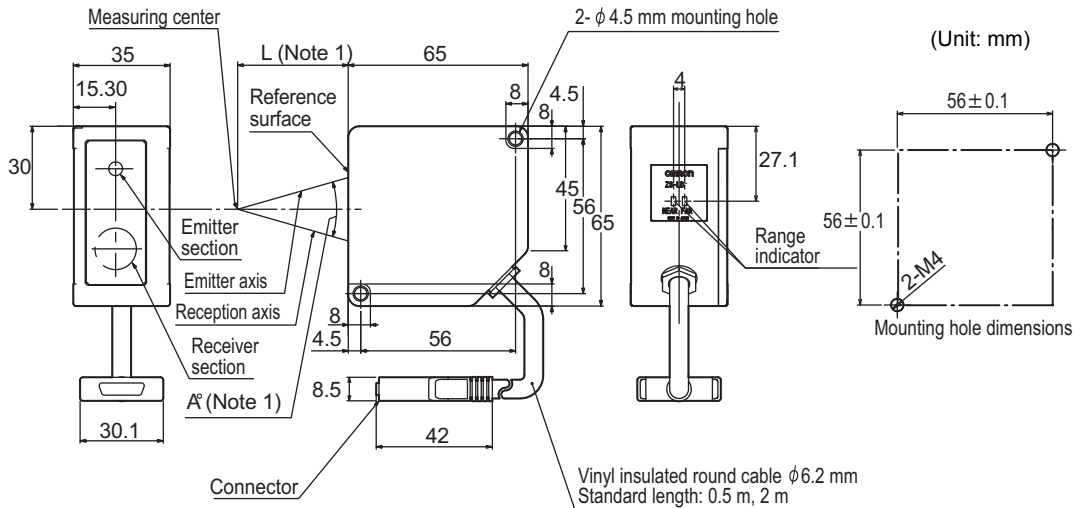

### ● ZS-HLDS5T/HLDS10

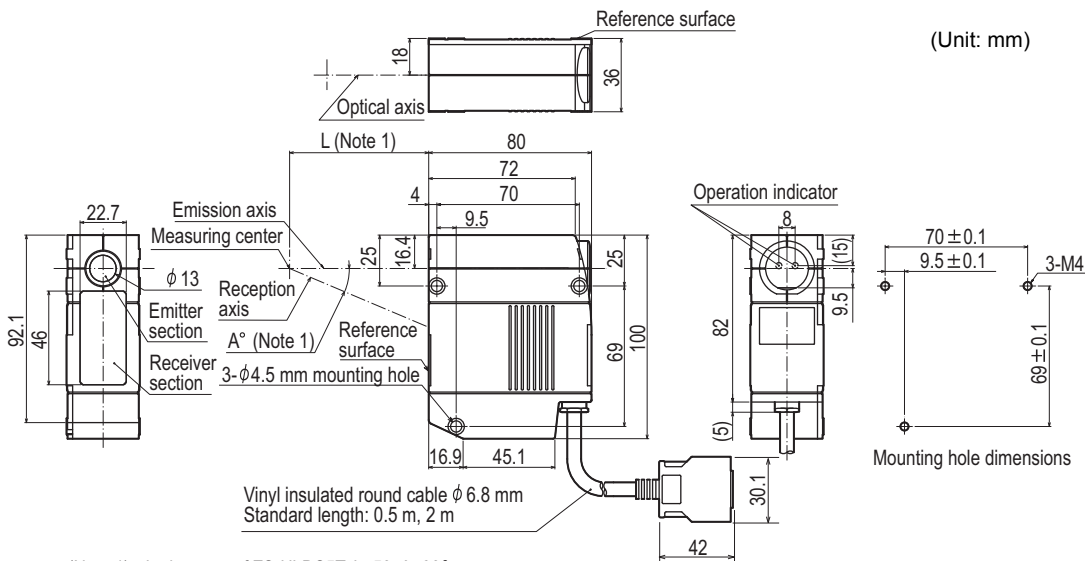

(Note 1): In the case of ZS-HLDS5T, L=50, A=30°  
In the case of ZS-HLDS10, L=100, A=25°

- When used in regular reflection (ZS-HLDS5T)

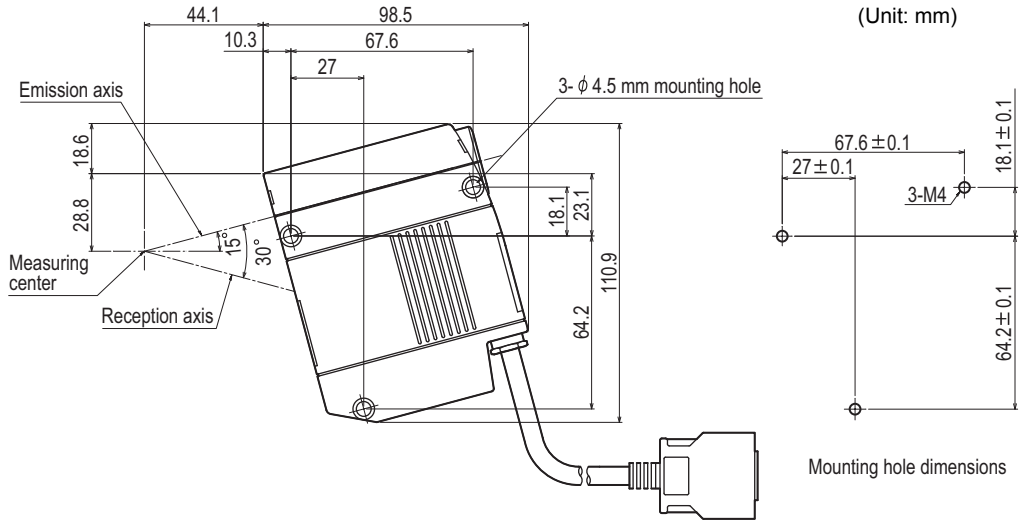

- When used in regular reflection (ZS-HLDS10)

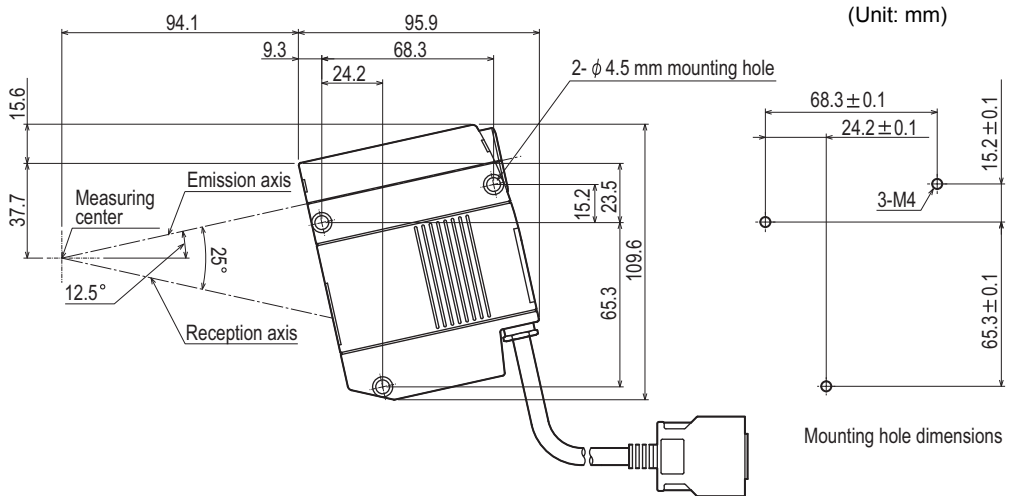

● ZS-HLDS60/HLDS150

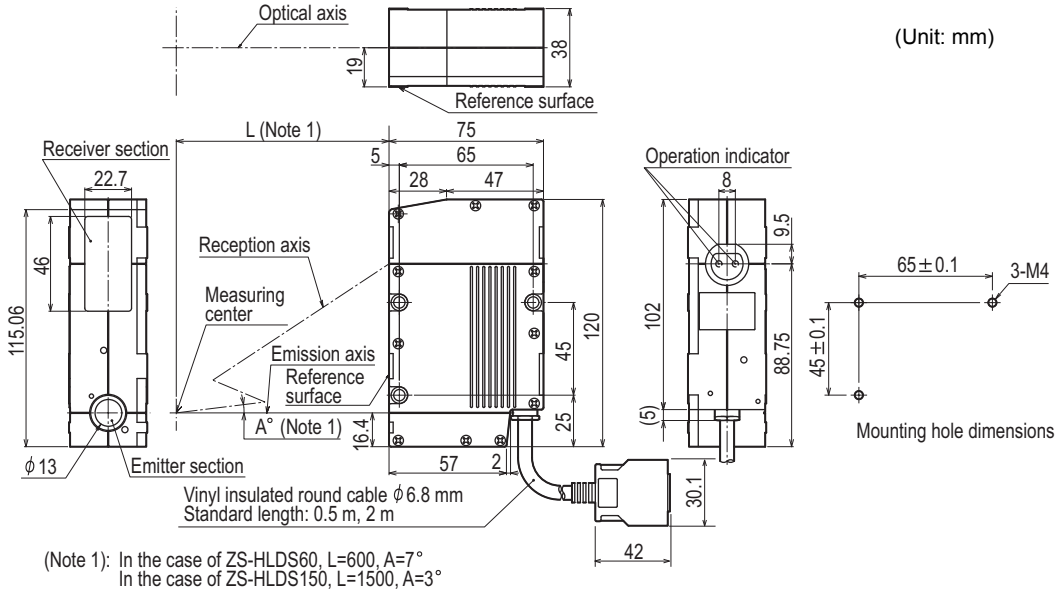

● ZS-LD10GT

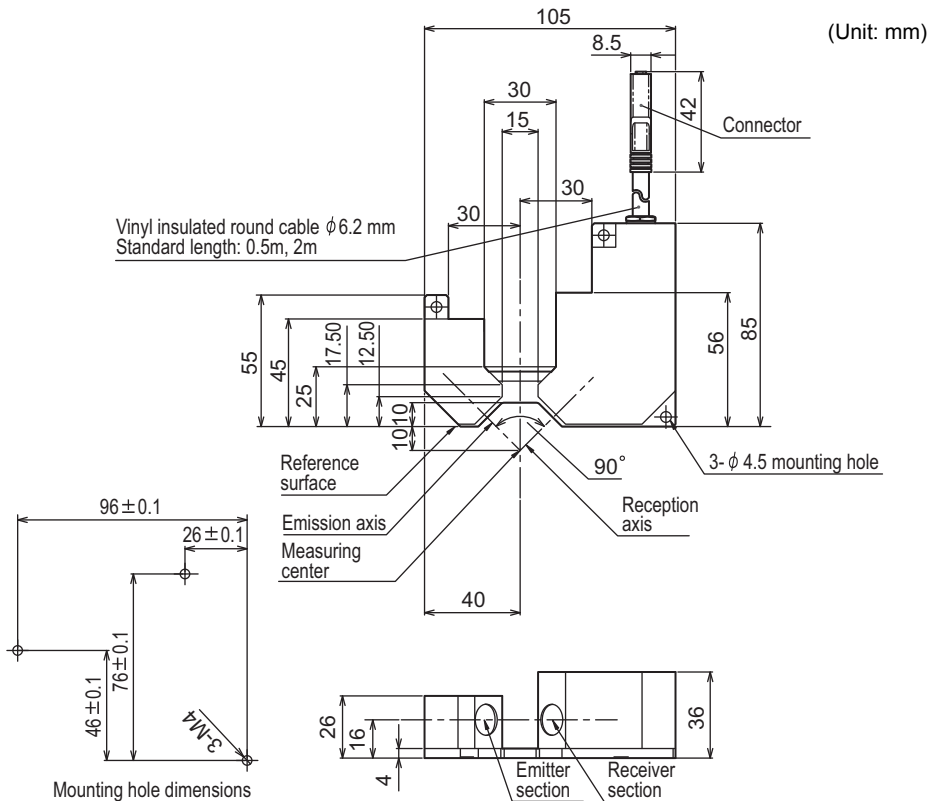

● ZS-LD15GT

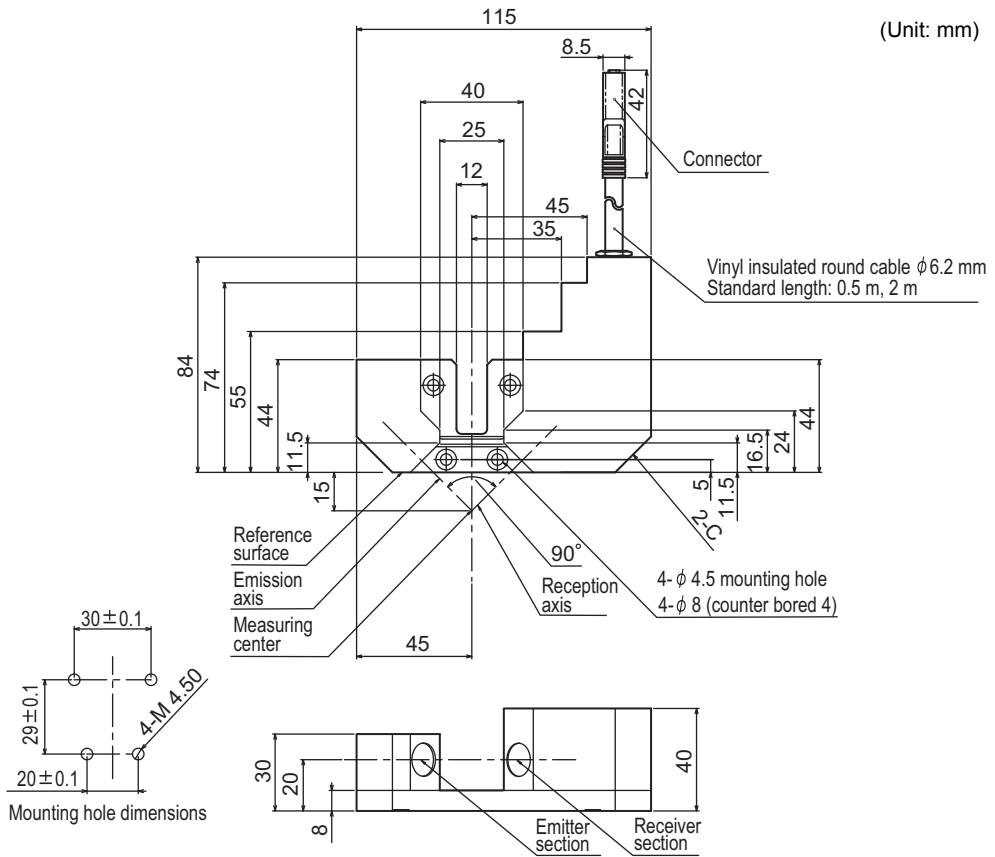

● ZS-LD20T/LD20ST/LD40

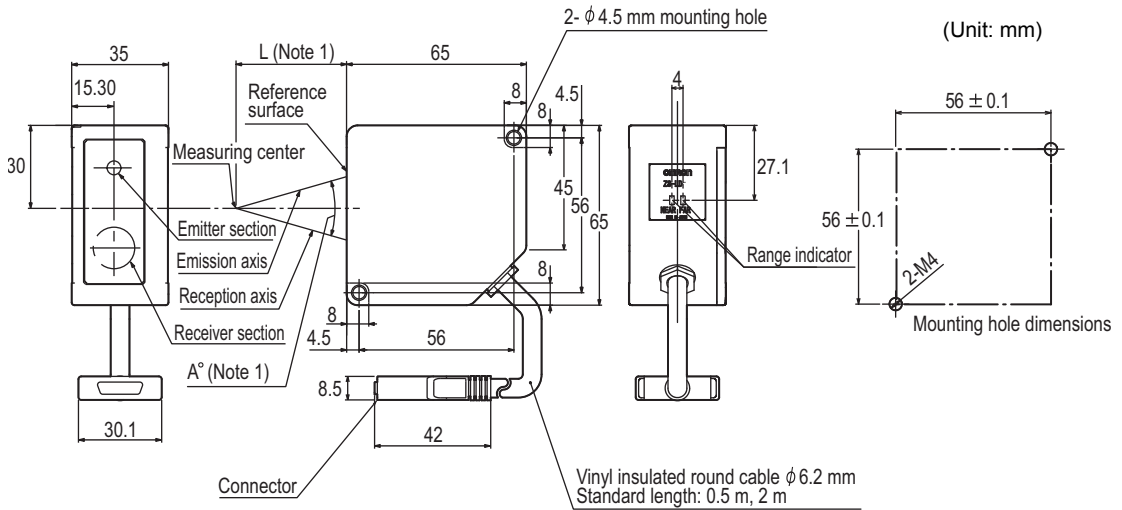

(Note 1): In the case of ZS-LD20T/LD20ST, L=20, A=45°  
In the case of ZS-LD40T, L=40, A=32°

• When used in diffuse reflection (ZS-LD20T/LD20ST)

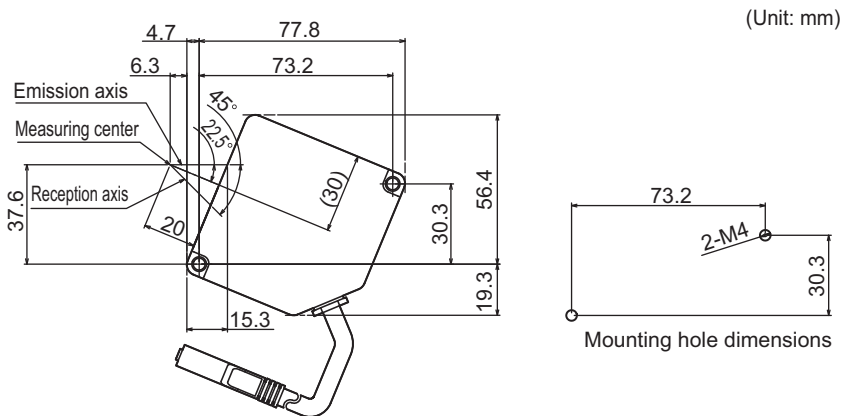

• When used in diffuse reflection (ZS-LD40T)

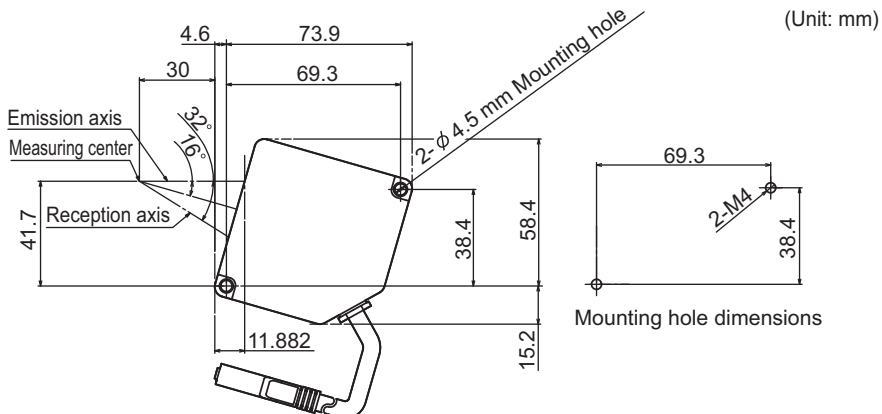

● **ZS-LD50/LD50S/LD80/LD130/LD200/LD350S**

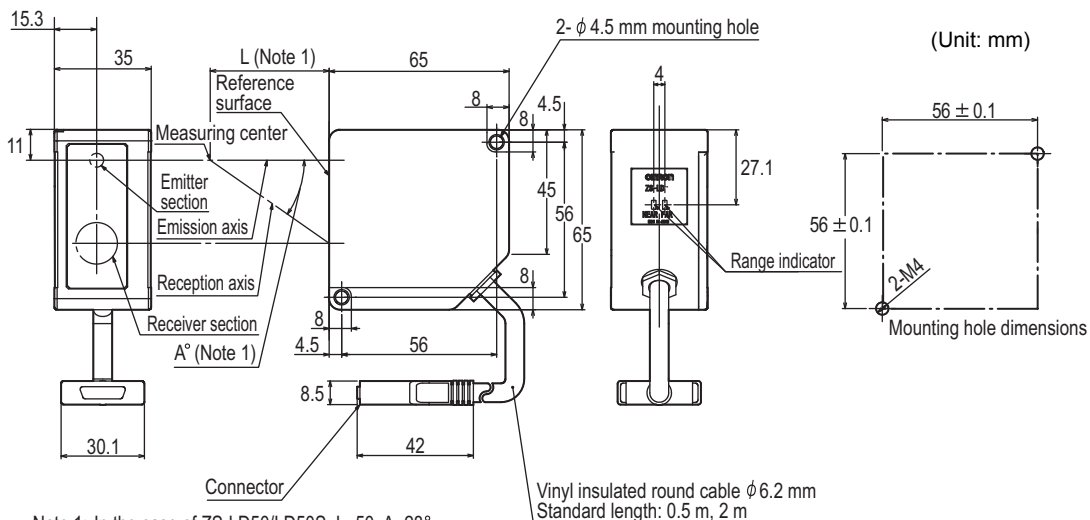

Note 1: In the case of ZS-LD50/LD50S, L=50, A=28°  
 In the case of ZS-LD80, L=80, A=15°  
 In the case of ZS-LD130, L=130, A=12°  
 In the case of ZS-LD200, L=200, A=8°  
 In the case of ZS-LD350S, L=350, A=5°

• When used in regular reflection (ZZS-LD50/LD50S)

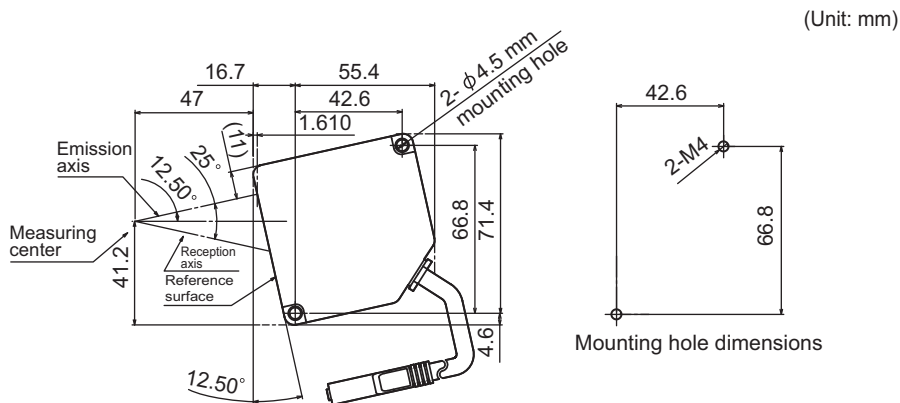

• When used in regular reflection (ZS-LD80)

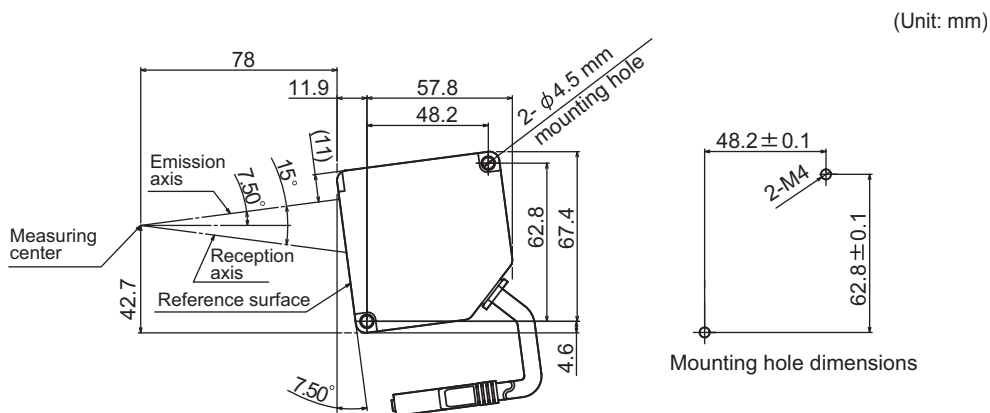

- When used in regular reflection (ZS-LD130)

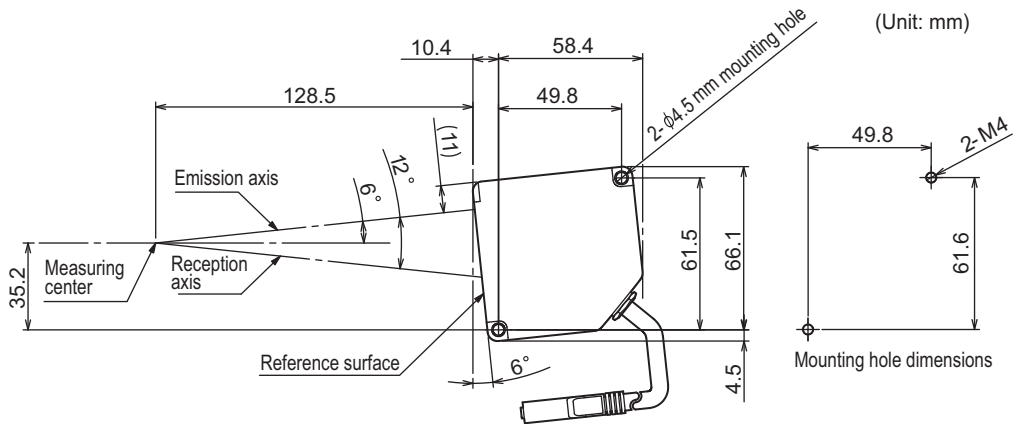

- When used in regular reflection (ZS-LD200)

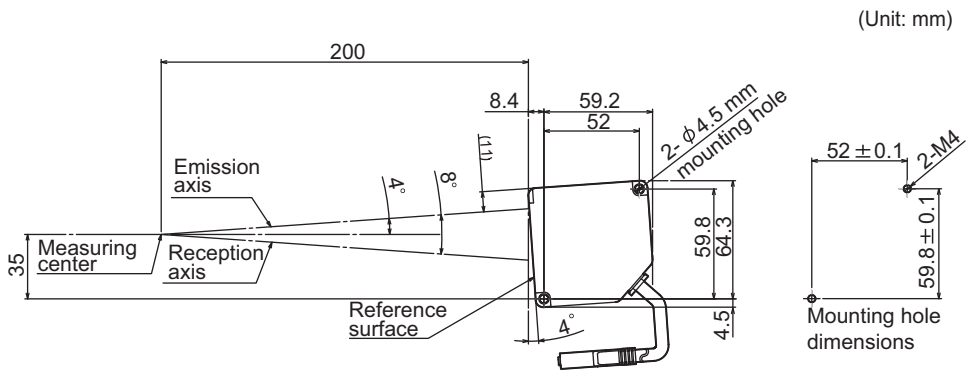

## Adjusting Mutual Interference

When using two or more Sensor Heads next to each other, mutual interference will not occur if other beam spots are outside the shaded areas in the following diagrams.

- ZS-HLDS2VT

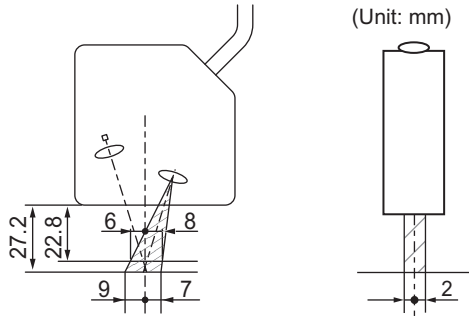

- ZS-HLDS5T

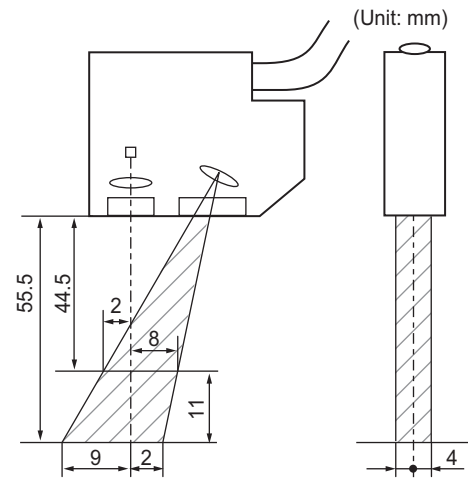

- ZS-HLDS10

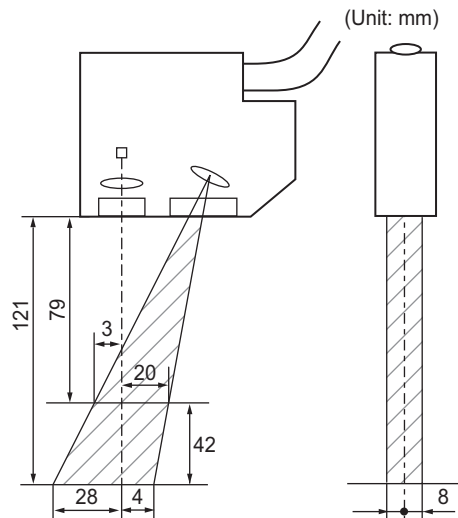



- ZS-HLDS60

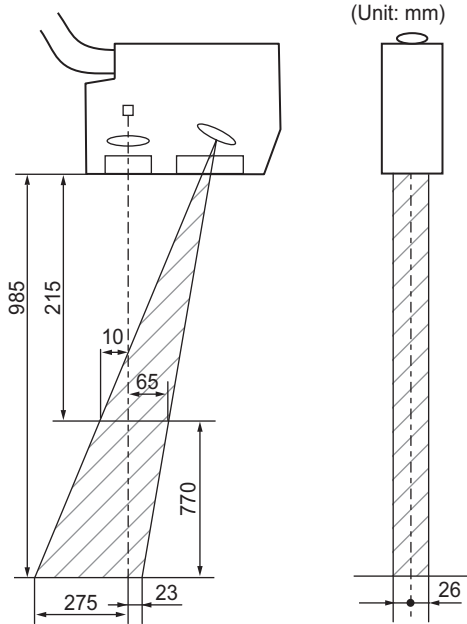

- ZS-HLDS150

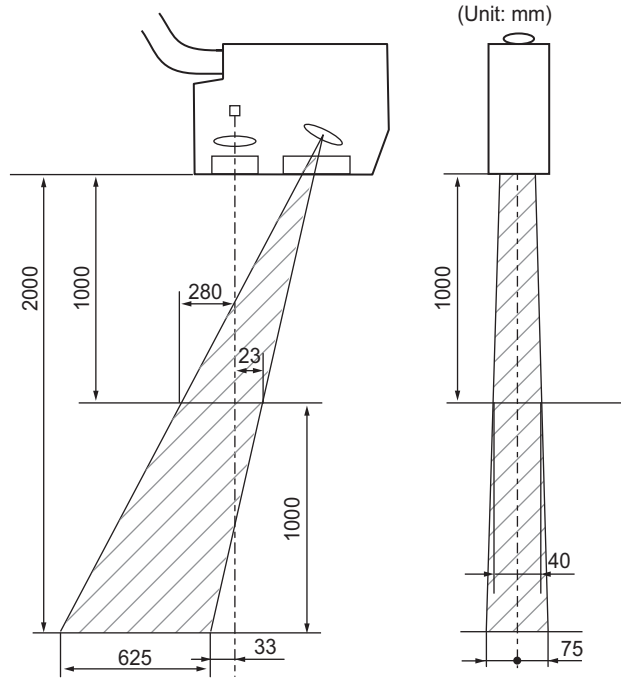

- ZS-LD20T/LD20ST

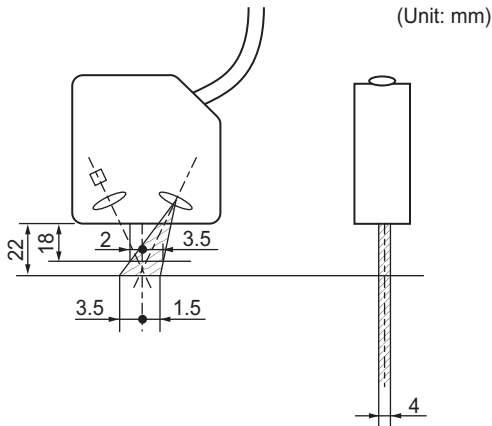

- ZS-LD40T

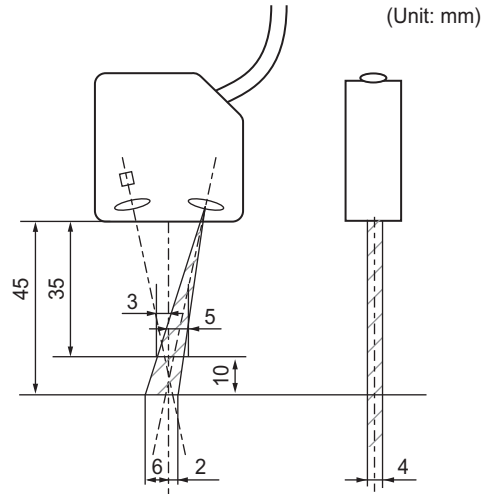

- ZS-LD50/LD50S

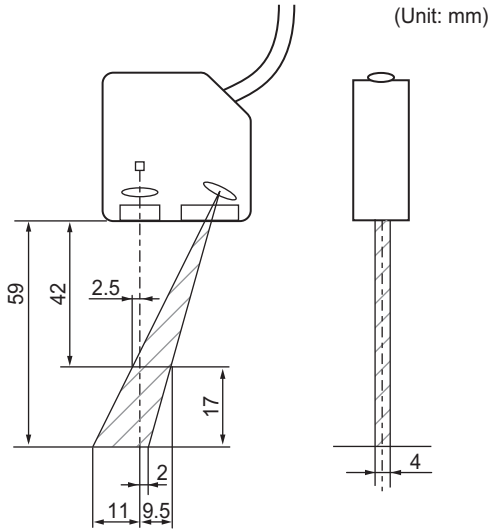

- ZS-LD80

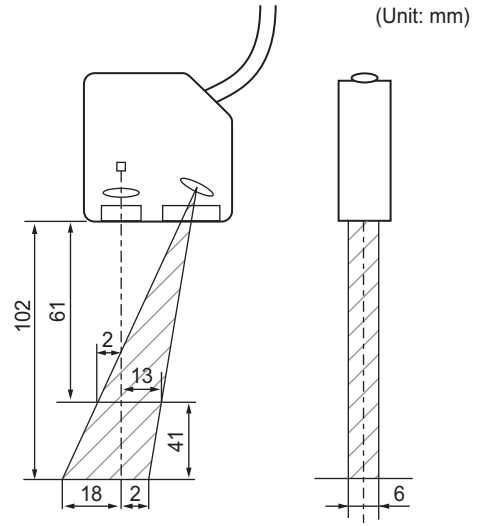

- ZS-LD130

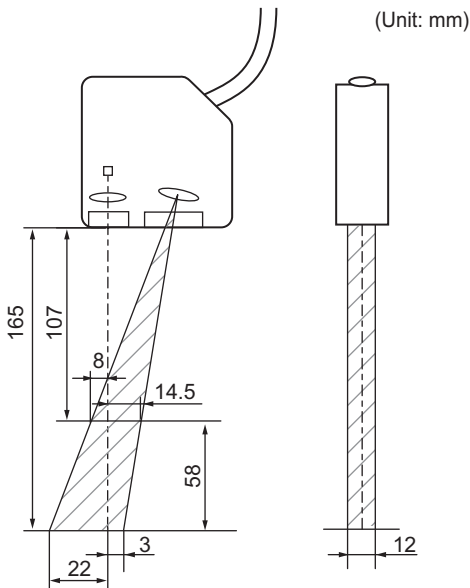

- ZS-LD200

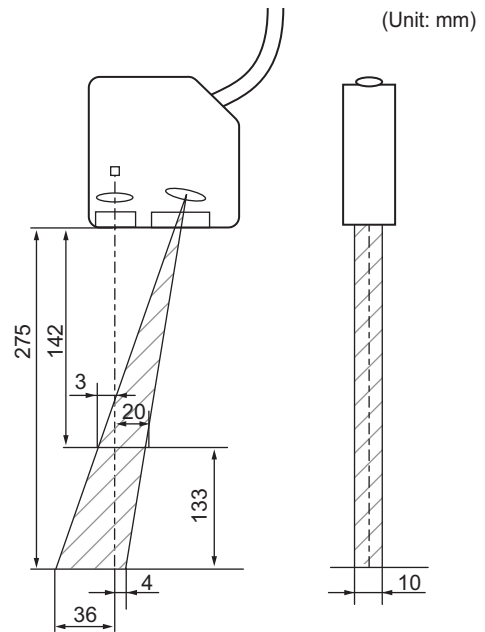

- ZS-LD350S

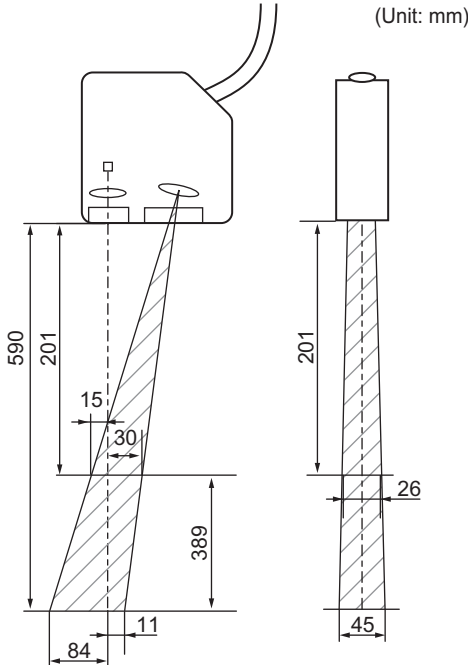

# Spot Diameter

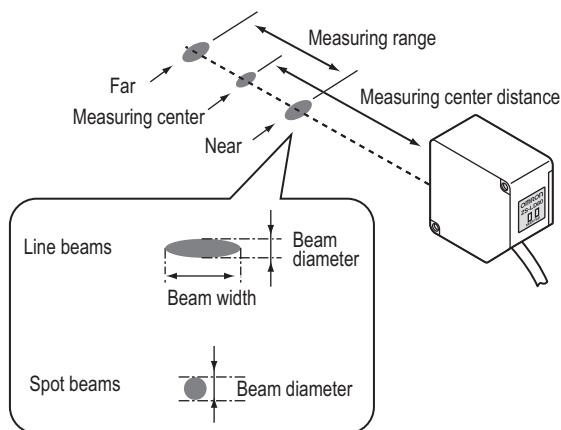

• ZS-HLDS Series

	Beam diameter × beam width (μm)				
	HLDS2VT	HLDS5T	HLDS10	HLDS60	HLDS150
Near	75 × 2,200	260 × 1,000	500 × 3500	960 × 13,000	1,700 × 33,000
Measurement center	45 × 2,200	30 × 1,000	60 × 3500	300 × 21,000	1,500 × 40,000
Far	75 × 2,200	260 × 1,000	500 × 3500	1600 × 32,000	5,000 × 60,000

• ZS-LD Series (Line Beam Type)

	Beam diameter × beam width (μm)							
	LD10GT	LD15GT	LD20T	LD40T	LD50	LD80	LD200	LD130
Near	65 × 900	50 × 900	60 × 900	90 × 2,000	90 × 900	300 × 900	430 × 900	220 × 620
Measurement center	25 × 900	25 × 900	25 × 900	35 × 2,000	60 × 900	60 × 900	100 × 900	70 × 600
Far	65 × 900	50 × 900	60 × 900	100 × 2,000	230 × 900	330 × 900	430 × 900	200 × 570

• ZS-LD Series (Spot Beam Type)

	LD20ST	LD50S	LD350S
Near	ø 50 μm	ø 110 μm	ø 370 μm
Measurement center	ø 25 μm	ø 50 μm	ø 240 μm
Far	ø 40 μm	ø 110 μm	ø 490 μm

## Usage Width of Line Beam

Depending on the measurement mode, the beam width used for the actual measurement differs. When you use the [CUSTOM] menu, you can specify the setting for performing sensing for the entire area of the line beam.

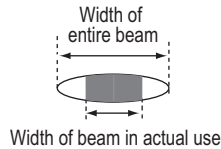

### • ZS-HLDS Series

		Beam width				
		HLDS2VT	HLDS5T	HLDS10	HLDS60	HLDS150
	Entire width of beam (measurement center)	2,200 μm	1,000 μm	3,500 μm	21,000 μm	40,000 μm
Width of beam in actual use	High-Speed mode (2 lines)	30 μm	25 μm	70 μm	525 μm	1,143 μm
	Standard mode (9 lines)	135 μm	113 μm	315 μm	2,363 μm	5,144 μm
	High-Resolution/High-Sensitivity mode (40 lines)	600 μm	500 μm	1,400 μm	10,500 μm	22,860 μm
When you want to use the entire width of beam	The number of lines that should be set in the [CUSTOM] menu	150 lines	80 lines	100 lines	80 lines	70 lines
	EXPOSE	8.4 ms	4.48 ms	5.6 ms	4.48 ms	3.92 ms

### • ZS-LD Series

		Beam width				
		LD10GT	LD15GT	LD20T	LD40T	LD50
	Entire width of beam (measurement center)	900 μm	900 μm	900 μm	2,000 μm	900 μm
Width of beam in actual use	High-Speed mode (2 lines)	10 μm	12 μm	12 μm	20 μm	26 μm
	Standard mode (9 lines)	45 μm	55 μm	55 μm	90 μm	120 μm
	High-Resolution/High-Sensitivity mode (40 lines)	200 μm	240 μm	240 μm	400 μm	520 μm
When you want to use the entire beam width	Number of lines that should be set in the [CUSTOM] menu	200 lines	150 lines	150 lines	200 lines	70 lines
	Exposure time	11.2 ms	8.4 ms	8.4 ms	11.2 ms	3.9 ms

		Beam width		
		LD80	LD130	LD200
	Entire width of beam (measurement center)	900 μm	600 μm	900 μm
Width of beam in actual use	High-Speed mode (2 lines)	45 μm	56 μm	90 μm
	Standard mode (9 lines)	200 μm	250 μm	400 μm
	High-Resolution/High-Sensitivity mode (40 lines*)	900 μm	560 μm	900 μm
When you want to use the entire beam width	Number of lines that should be set in the [CUSTOM] menu	40 lines	22 lines	20 lines
	Exposure time	2.2 ms	1.2 ms	1.1 ms

\* For ZS-LD130/LD200/LD350S, 20 lines.

# Linearity Characteristic by Materials

## ■ ZS-HLDS2VT (mode: High-Resolution)

### ● Regular reflection

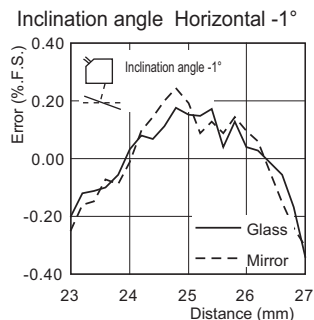
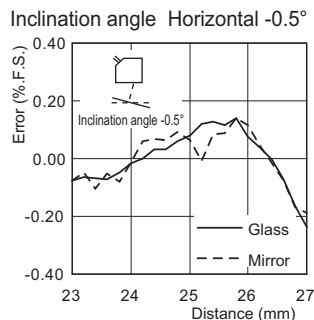
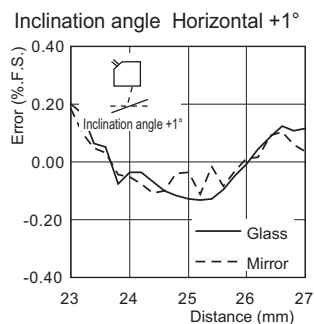
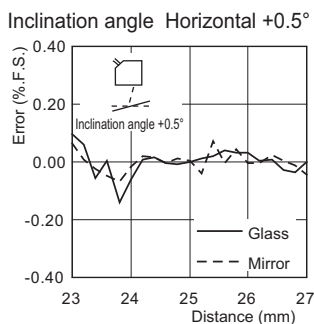
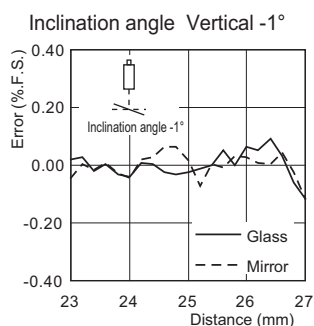
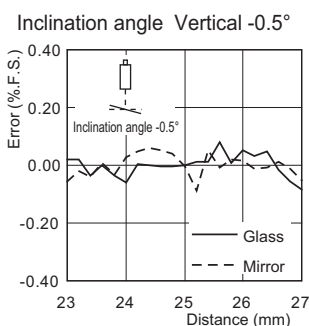
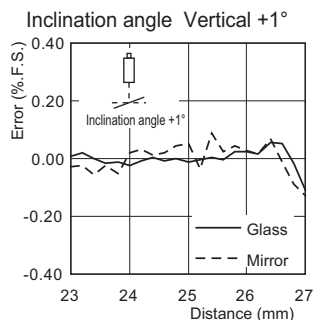
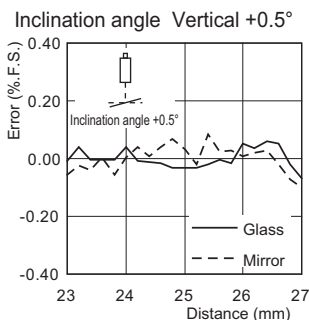
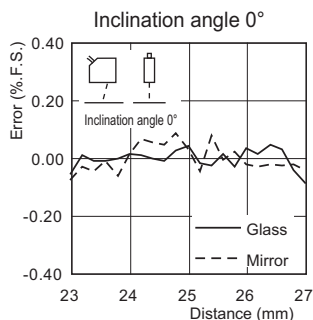

## ■ ZS-HLDS5T (mode: High-Resolution)

### ● Diffuse reflection

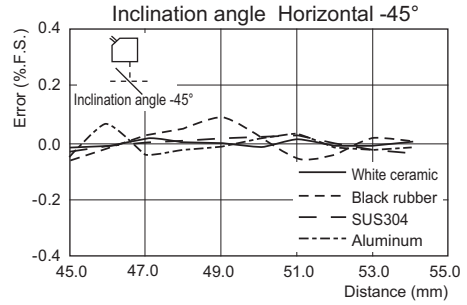
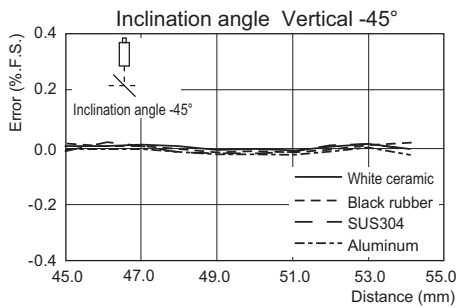
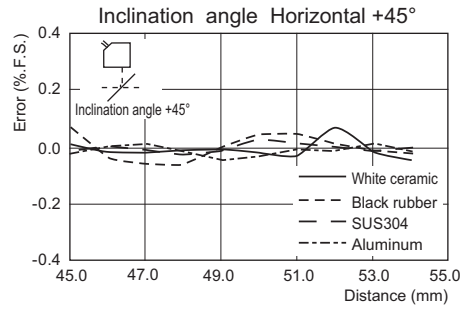
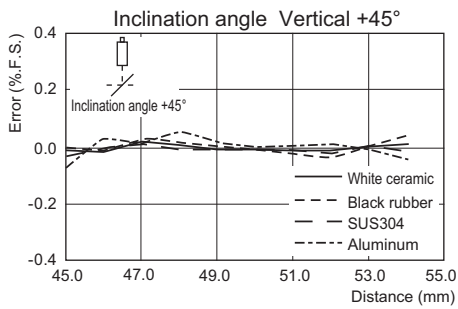
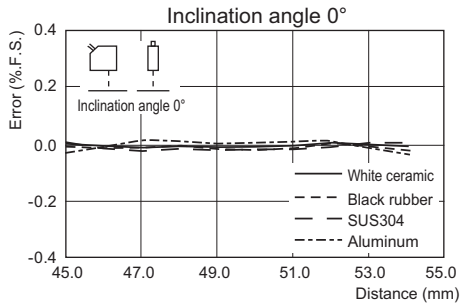

● **Regular reflection**

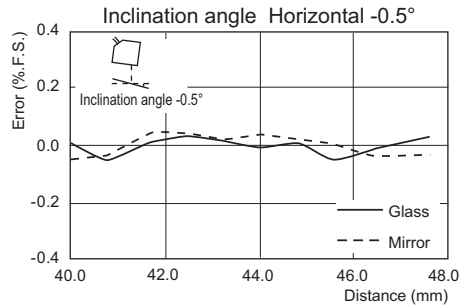
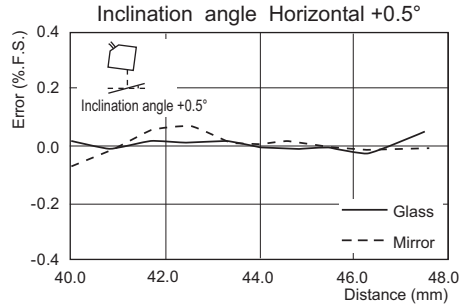
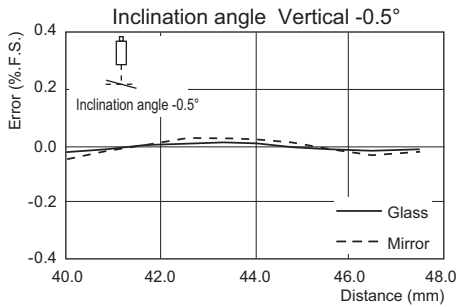
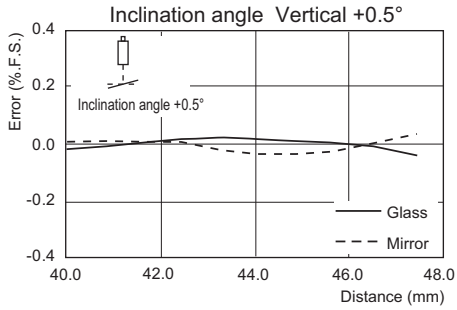
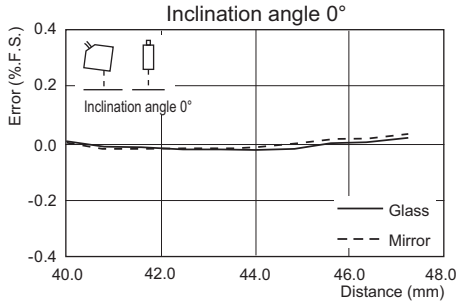



## ■ ZS-HLDS10 (mode: High-Resolution)

### ● Diffuse reflection

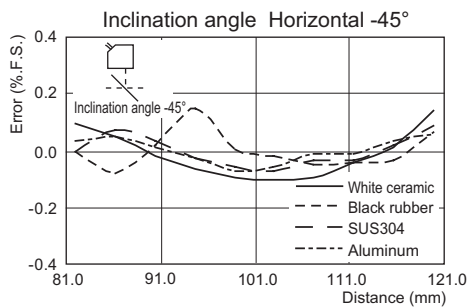
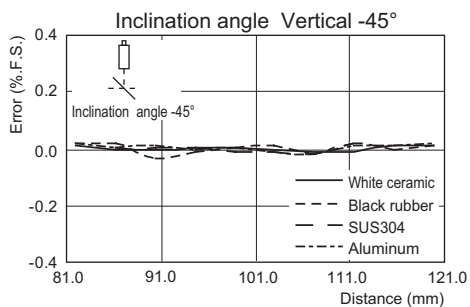
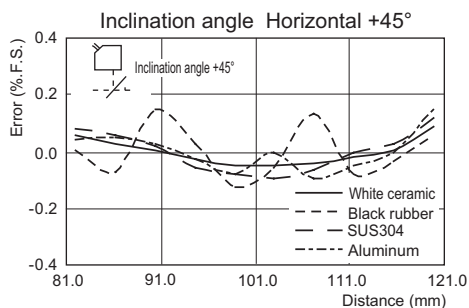
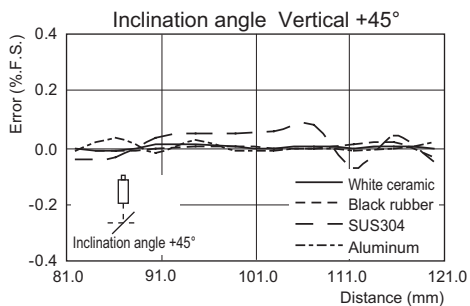
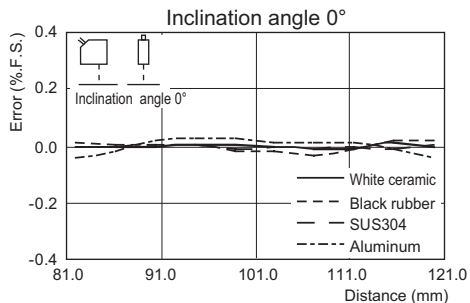

● **Regular reflection**

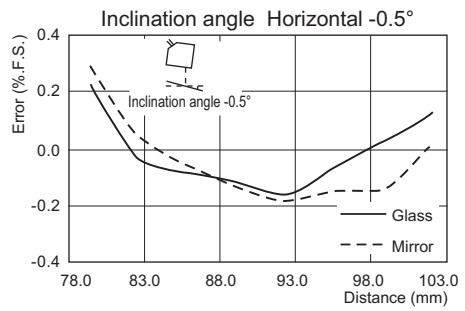
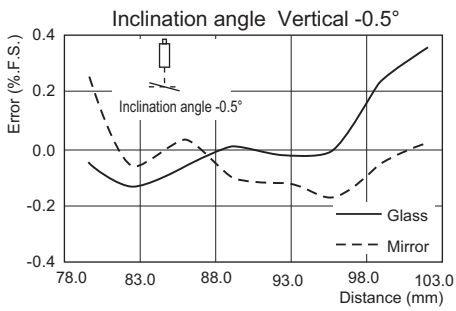
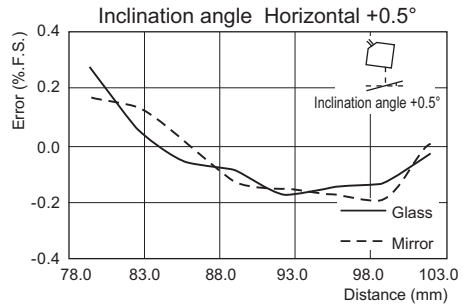
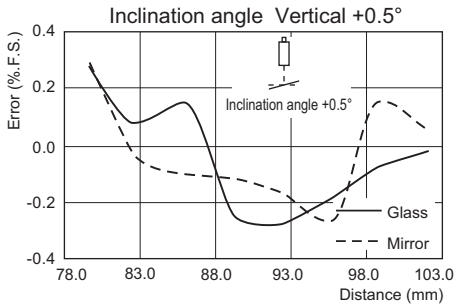
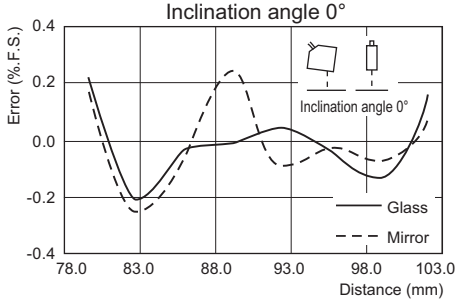

## ■ ZS-HLDS60 (mode: High-Resolution)

### ● Diffuse reflection

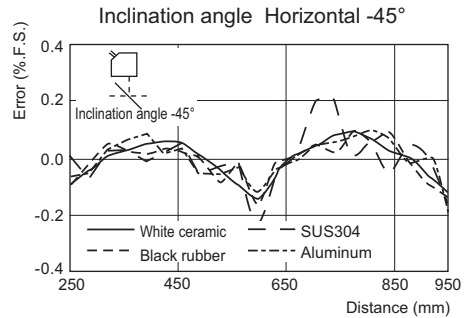
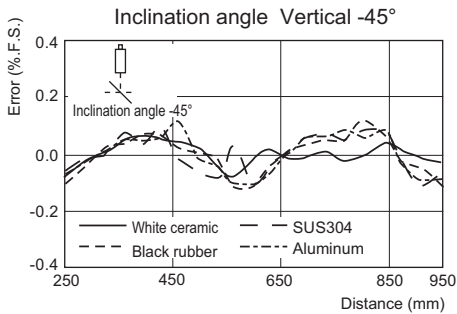
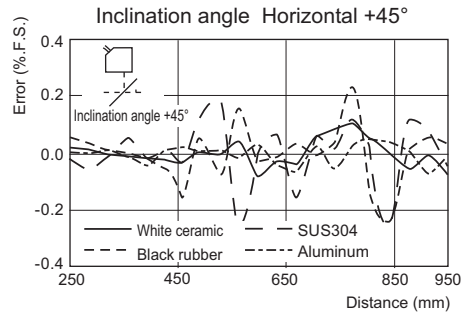
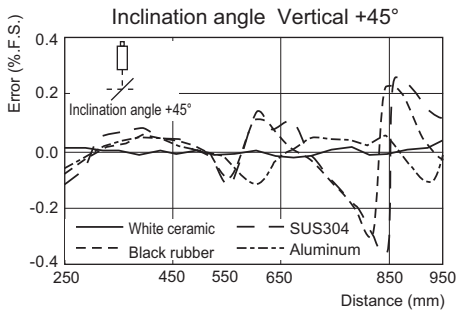
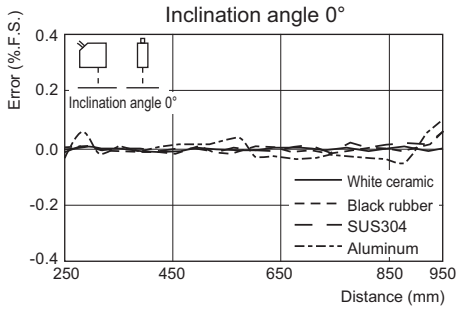

## ■ ZS-HLDS150 (mode: High-Resolution)

### ● Diffuse reflection

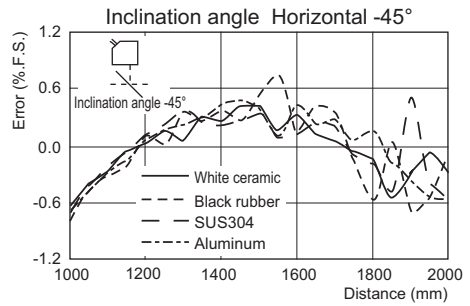
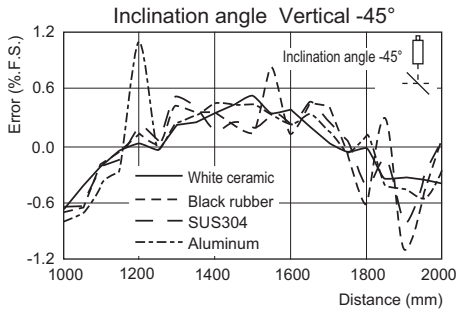
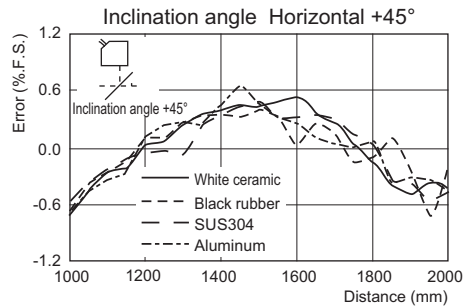
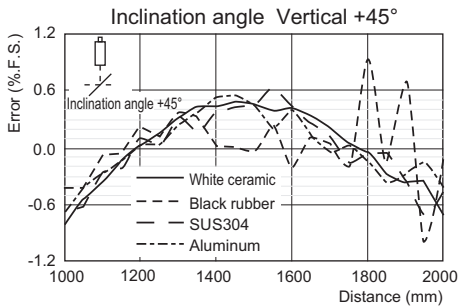
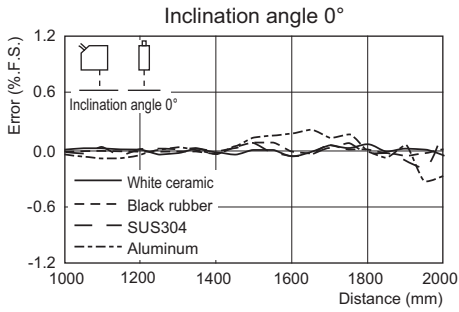

## ■ ZS-LD20T (mode: Standard)

### ● Regular reflection

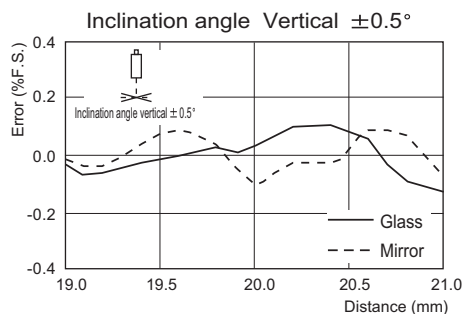
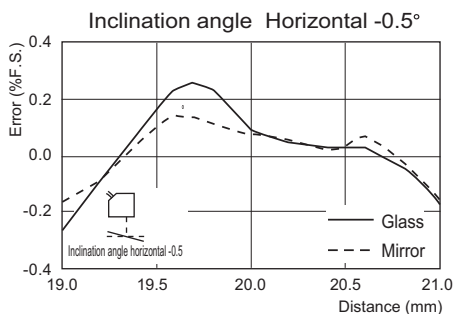
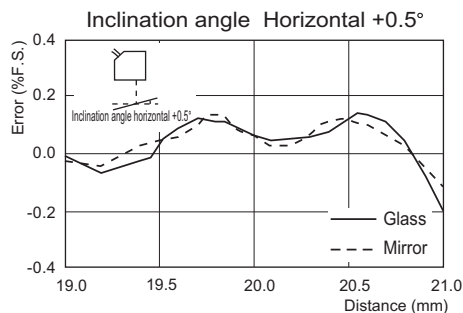
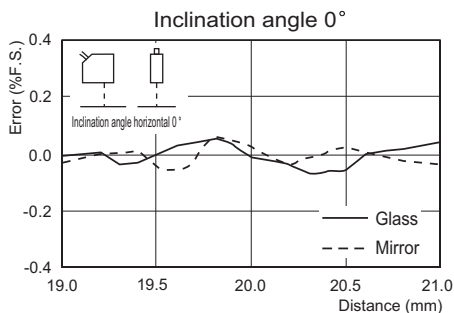

### ● Diffuse reflection

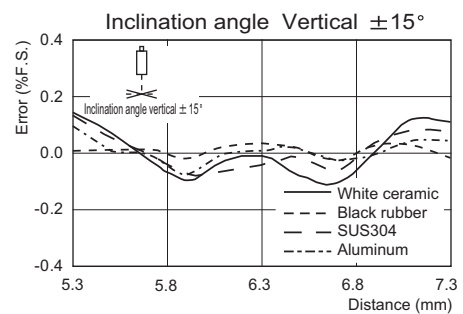
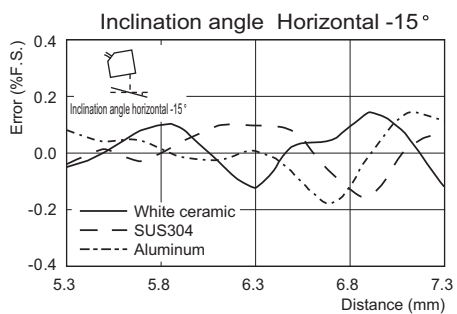
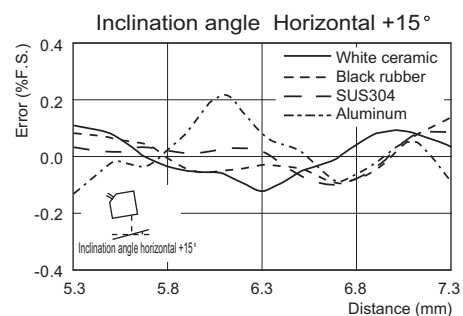
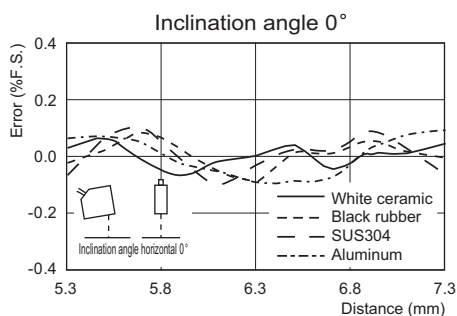

## ■ ZS-LD20ST (mode: Standard)

### ● Regular reflection

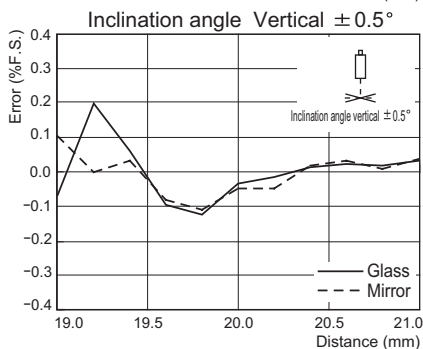
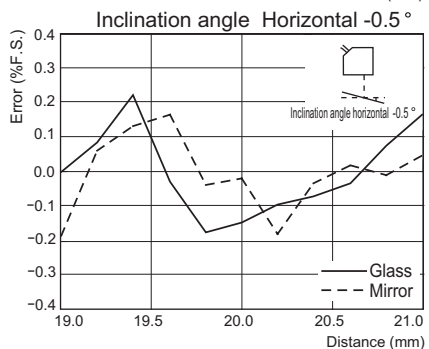
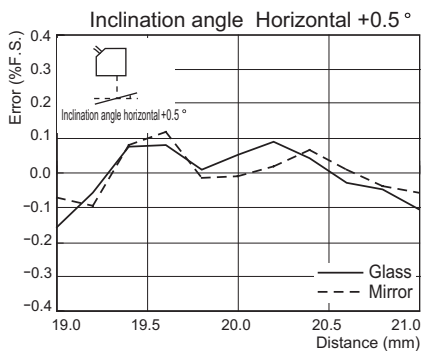
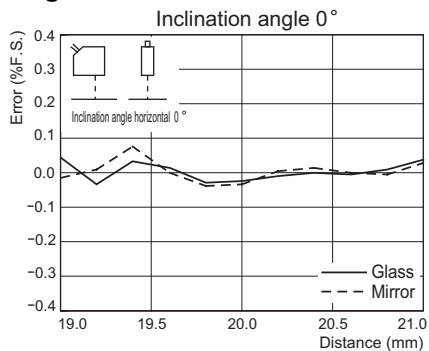

### ● Diffuse reflection

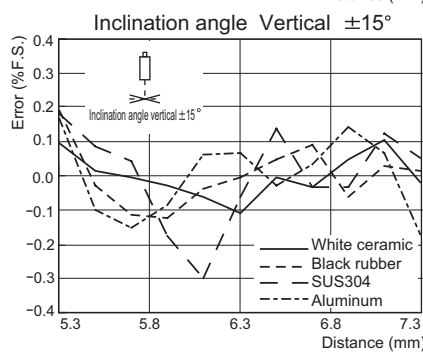
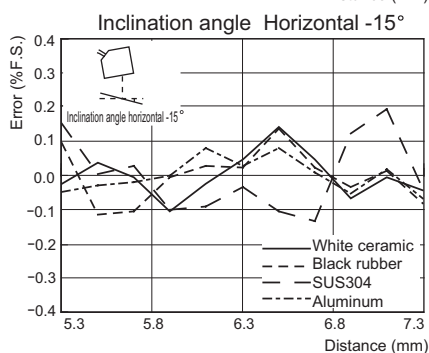
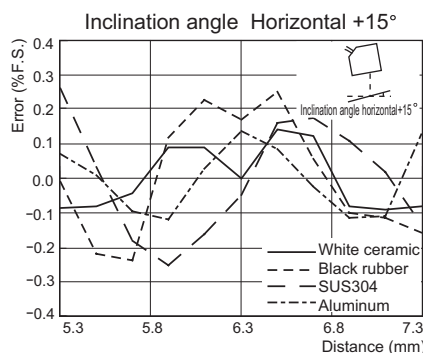
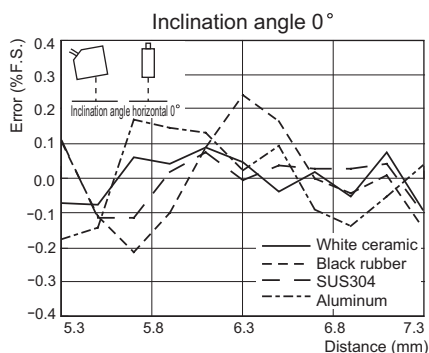

## ■ ZS-LD40T (mode: Standard)

### ● Regular reflection

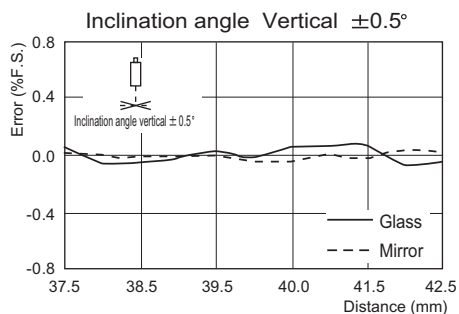
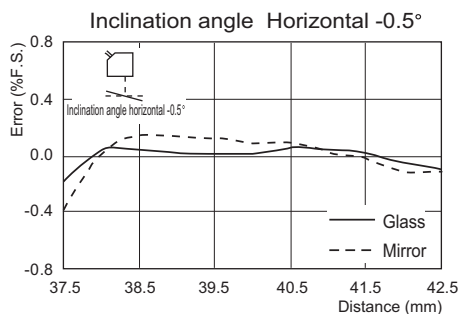
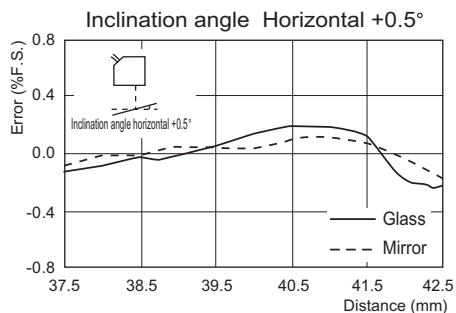
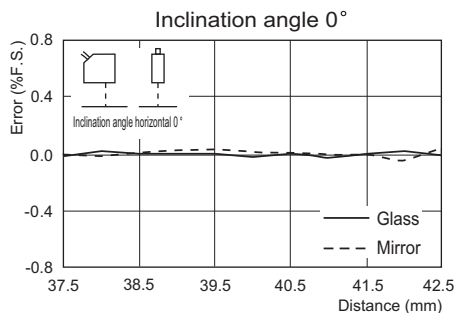

### ● Diffuse reflection

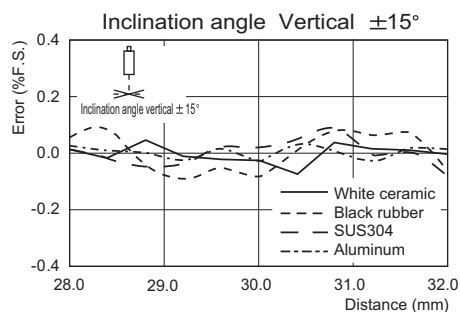
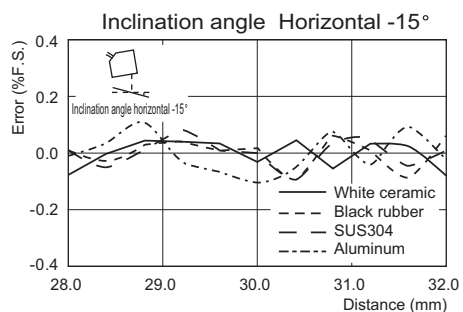
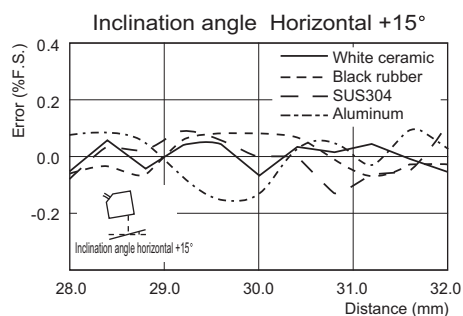
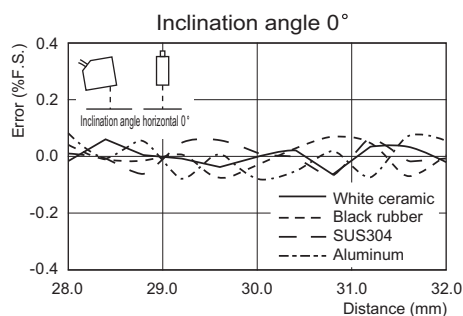

## ■ ZS-LD50 (mode: Standard)

### ● Diffuse reflection

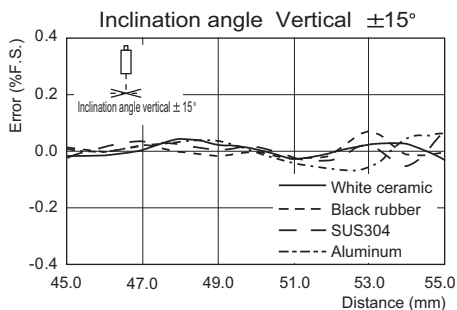
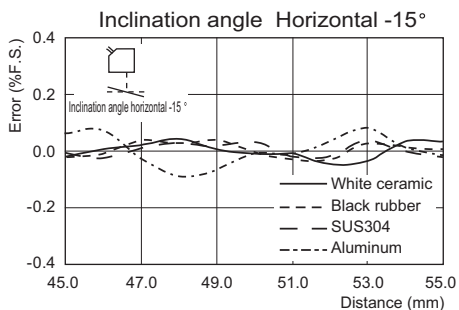
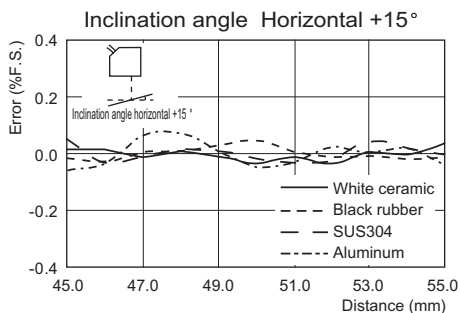
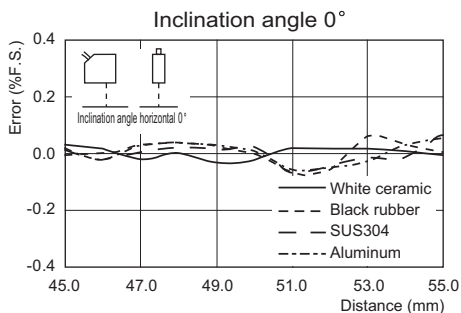

### ● Regular reflection

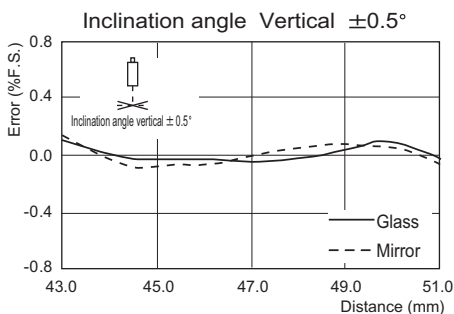
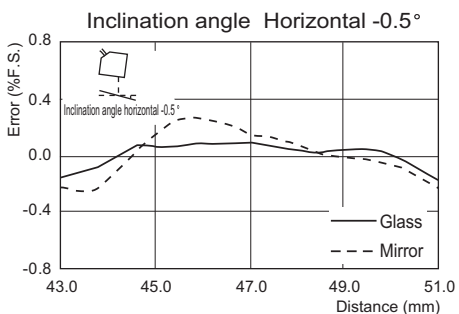
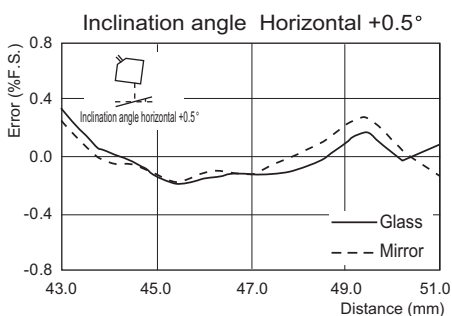
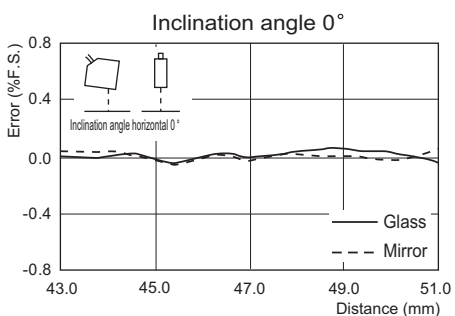



## ■ ZS-LD50S (mode: Standard)

### ● Diffuse reflection

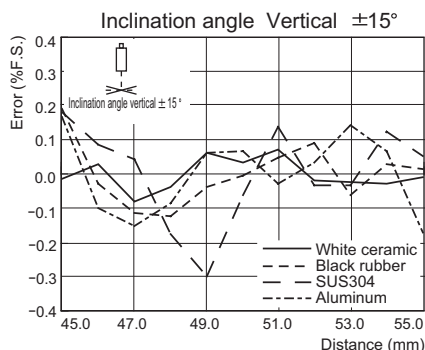
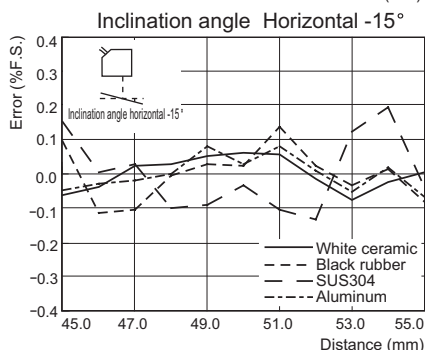
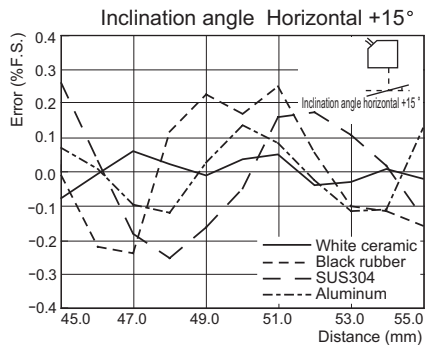
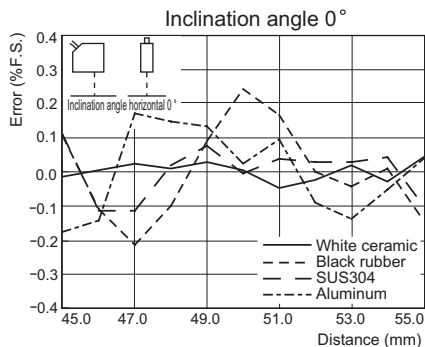

### ● Regular reflection

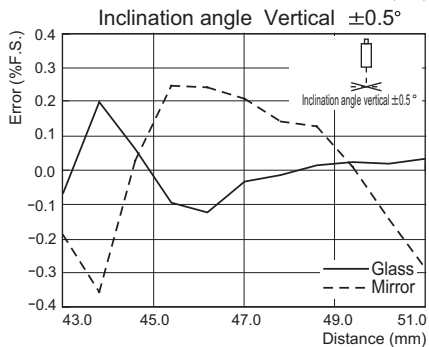
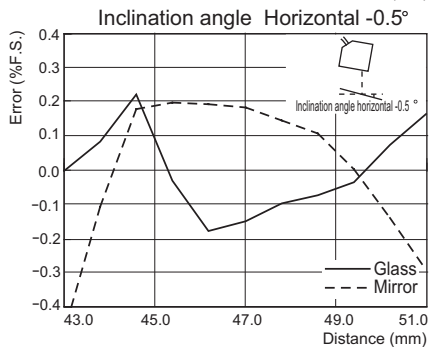
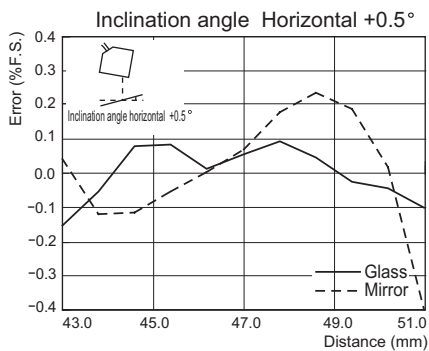
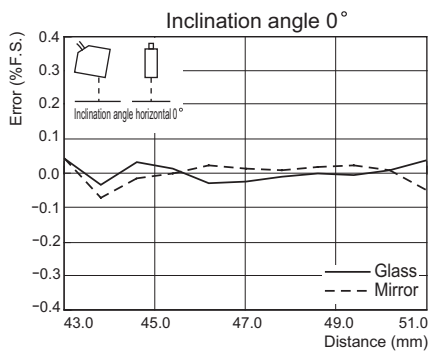

## ■ ZS-LD80 (mode: Standard)

### ● Diffuse reflection

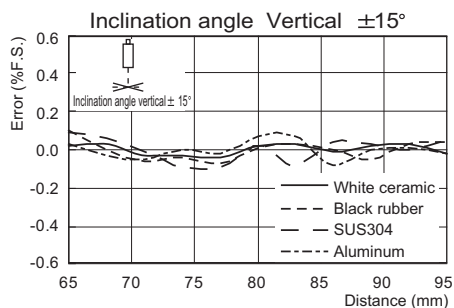
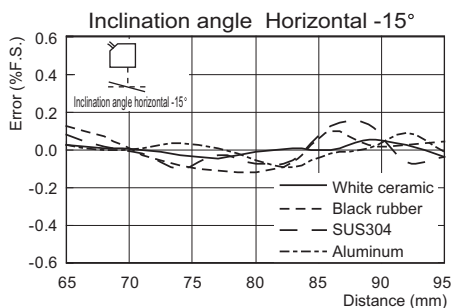
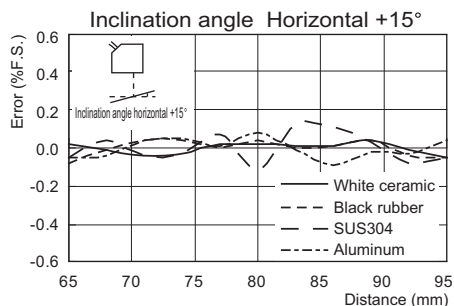
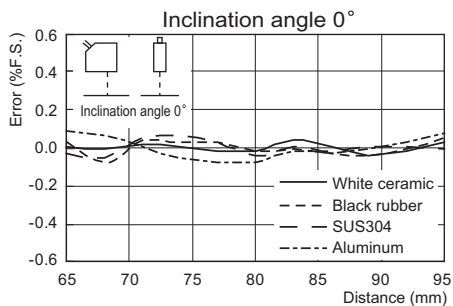

### ● Regular reflection

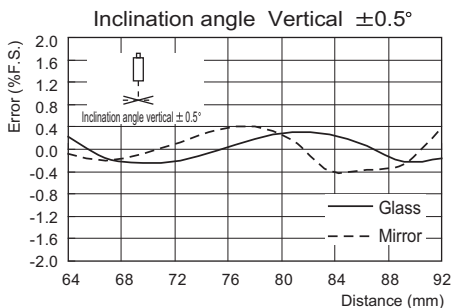
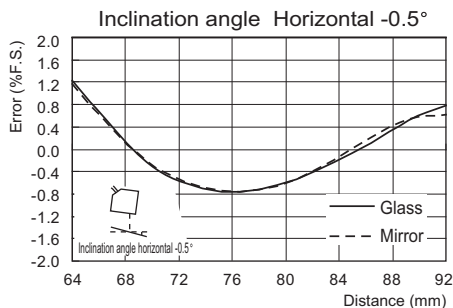
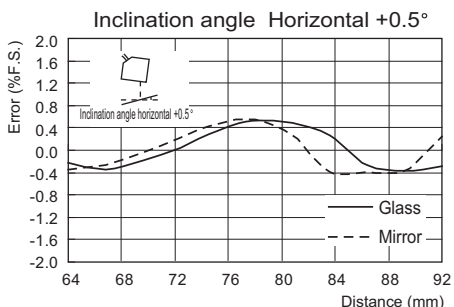
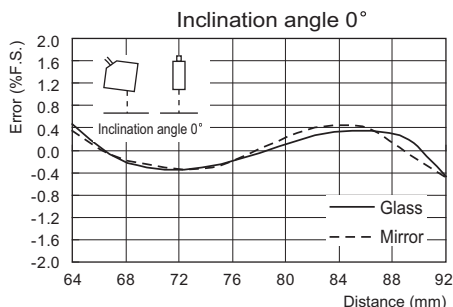

■ ZS-LD130 (mode: Standard)

● Diffuse reflection

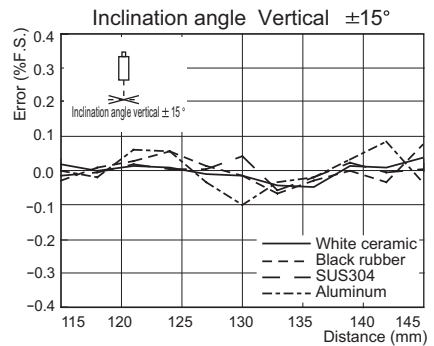
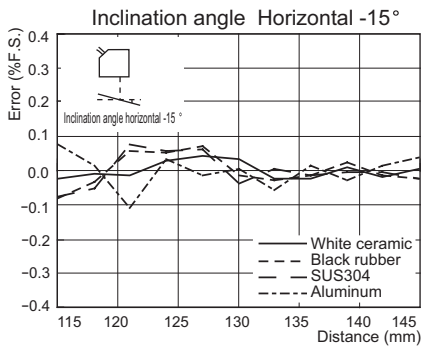
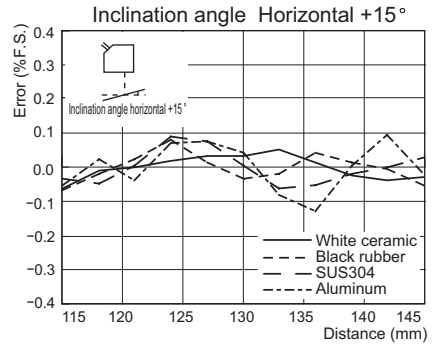
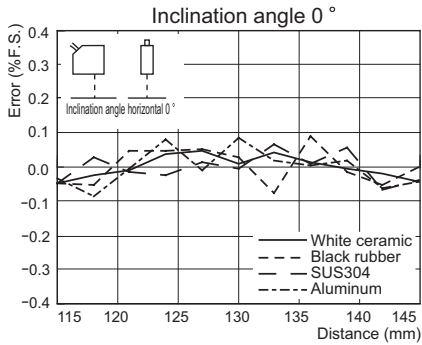

● Regular reflection

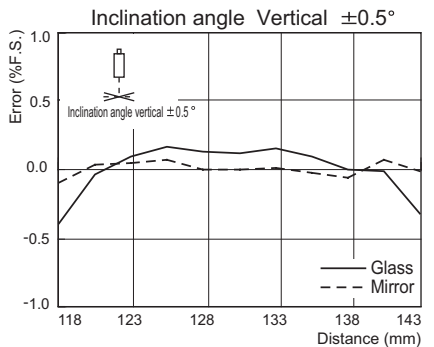
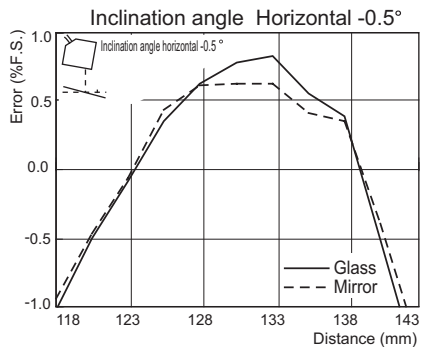
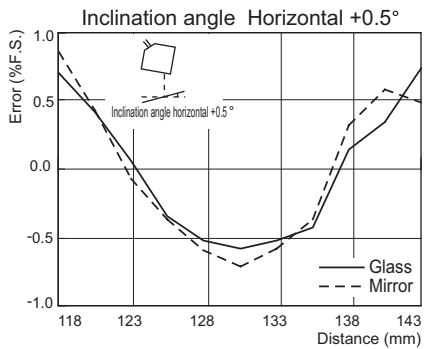
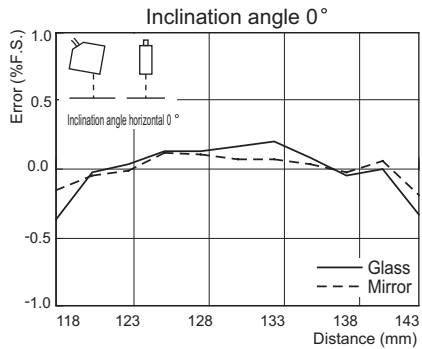

## ■ ZS-LD200 (mode: Standard)

### ● Diffuse reflection

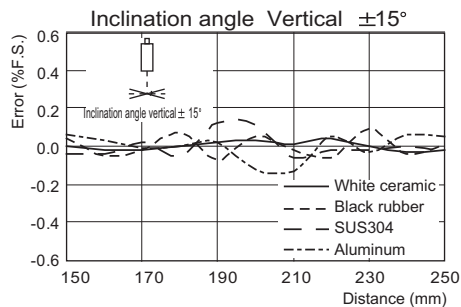
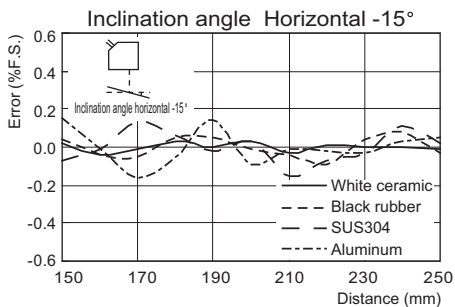
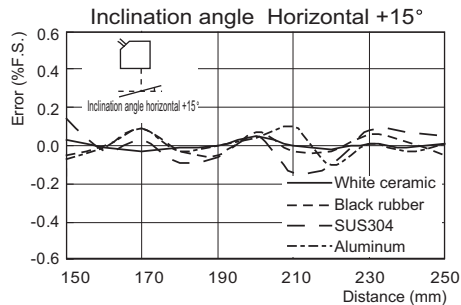
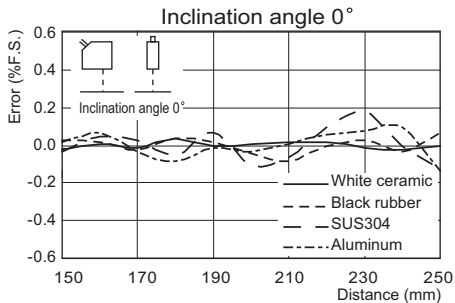

### ● Regular reflection

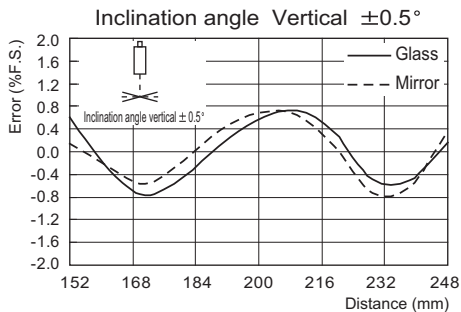
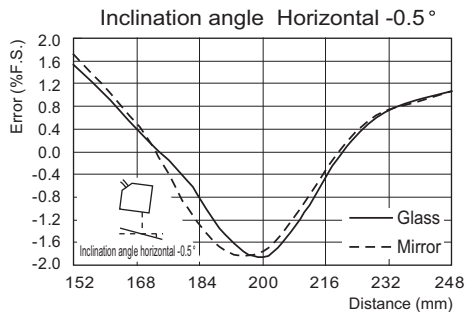
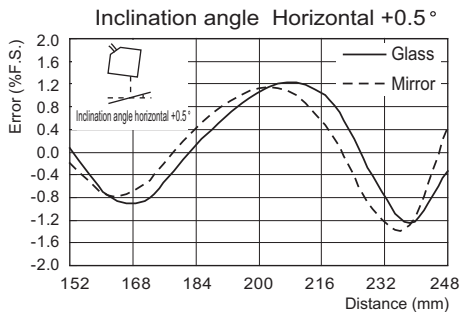
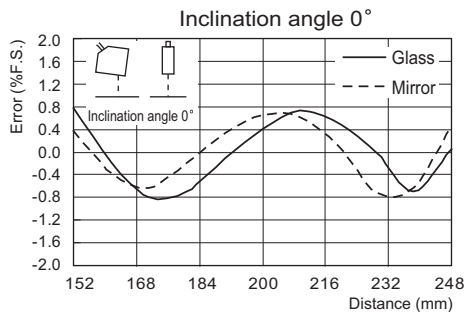

■ ZS-LD350S (mode: Standard)

● Diffuse reflection

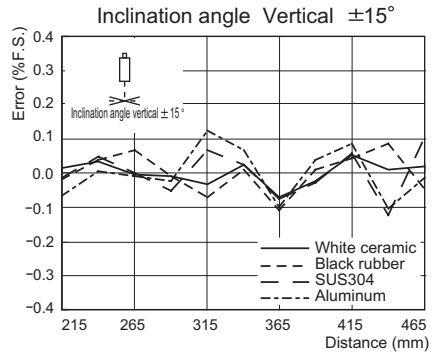
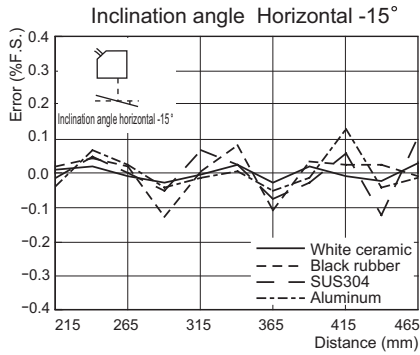
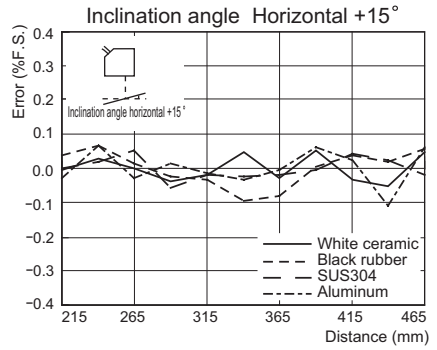
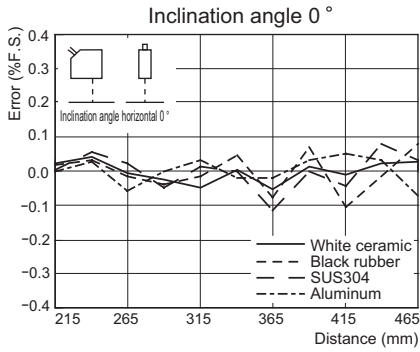

# Sensor Controller

## Specifications

Item		ZS-HLDC11	ZS-HLDC41	
I/O type		NPN type	PNP type	
Average number of times		1, 2, 4, 8, 16, 32, 64, 128, 256, 512, 1024, 2048, or 4096		
Number of connected Sensor Heads		1 per Sensor Controller		
External I/F	Connection method		Serial I/O is connector type. Otherwise, prewired (standard cable length: 2 m)	
	Serial I/O	USB2.0	1 port, FULL SPEED[12 Mbps], MINI-B	
		RS-232C	1 port, max. 115,200 bps	
	Output	3 judgment outputs: HIGH/PASS/LOW	NPN open-collector, 30 VDC, 50 mA max. residual voltage; 1.2 V max.	PNP open-collector 50 mA max. residual voltage; 1.2 V max.
		Linear output	Selectable from voltage/current (selected by slide switch on base) • At voltage output: -10 to +10 V, output impedance: 40 Ω • At current output: 4 to 20 mA, max. load resistance: 300 Ω	
Input	LDOFF input (LD forced OFF)	ON: Short-circuited with 0V terminal or 1.5 V max.	ON: Supply voltage short-circuited or within supply voltage -1.5 V max.	
	Zero reset input (execute or cancel zero reset)	OFF: Open (leakage current: 0.1 mA max.)	OFF: Open (leakage current: 0.1 mA max.)	
	Timing input (sample cycle specified when hold function is enabled)			
	Reset input (reset of hold state)			
Status indicators		HIGH (orange), PASS (green), LOW (orange), LDON (green), ZERO (green), ENABLE (green)		
Segment display	Main display	8-segment red display, 6 digits		
	Sub-display	8-segment green display, 6 digits		
LCD		16 digits × 2 rows, color of characters: green, resolution per character: 5 × 8 pixel matrix		
Setting input	Setting keys	Direction keys (UP/DOWN/LEFT/RIGHT), SET key, ESC key, MENU key, function keys (1 to 4)		
	Slide switch	Threshold switch (H/L 2-state) Mode switch (FUN/TEACH/RUN 3-state)		
Power supply voltage		21.6 V to 26.4 V (including ripple)		
Current consumption		0.5 A max. (when Sensor Head is connected)		
Insulation resistance		Across all lead wires and controller case: 20 MΩ (by 250 V megger)		
Dielectric strength		Across all lead wires and controller case, 1000 VAC, 50/60 Hz, 1 min		
Degree of protection		IP20 (IEC60529)		
Noise immunity		1,500 V peak-to-peak, pulse width 0.1 μs/1 μs, rising edge: 1 ns pulse		
Vibration resistance (destructive)		10 to 150 Hz, 0.7-mm double amplitude, 80 min each in X, Y, and Z directions		
Shock resistance (destructive)		300 m/s <sup>2</sup> 3 times each in six directions (up/down, left/right, forward/backward)		

Item	ZS-HLDC11	ZS-HLDC41
Ambient temperature	Operating: 0 to +50 °C Storage : -15 to +60 °C (with no icing or condensation)	
Ambient humidity	Operating and storage: 35 % to 85 % (with no condensation)	
Materials	Case: Polycarbonate (PC), Cable sheath: PVC	
Cable length	2 m	
Weight	Approx. 280 g (excluding packing materials and accessories)	

● **Status indicators for controller**

Measurement mode	Status		Display	Output			Input		RS-232C/USB
			7 segment display	Linear output	Judgment output	Terminal block output	Trigger/trigger reset/laser OFF	Zero reset	
RUN/TEACH	Normal measurement		Measurement result	Output according to the measurement result	Judgment result	Output according to the mode (measurement result/judgment result)	YES	YES	YES
	Measurement error	Keep	Previous value						
		Clamp	ERROR						
	Measured value not determined		–						
	LDOFF		–						
FUN	–		Display according to the menu	Output at clamp level	ERROR (Output OFF)	Output of the measured value: Clamp level Judgment output: ERROR	NO	NO	NO
System error	–		888.888 blinking						Voltage: Output of 0 V Current: Output of 12 mA

The programs incorporated into ZS-HLDC\_ \_ \_ Controllers are considered technology under the Foreign Exchange and Foreign Trade laws in Japan and therefore require a license for export from Japan.

Note, however, that permission for service transactions is not required in accordance with the stipulations of Trade Ministry Directive, Clause No. 9, Item No. 1 Sub-item 10(b).

# External Dimensions

ZS-HLDC11/HLDC41

(Unit: mm)

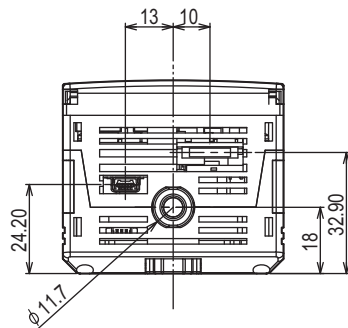
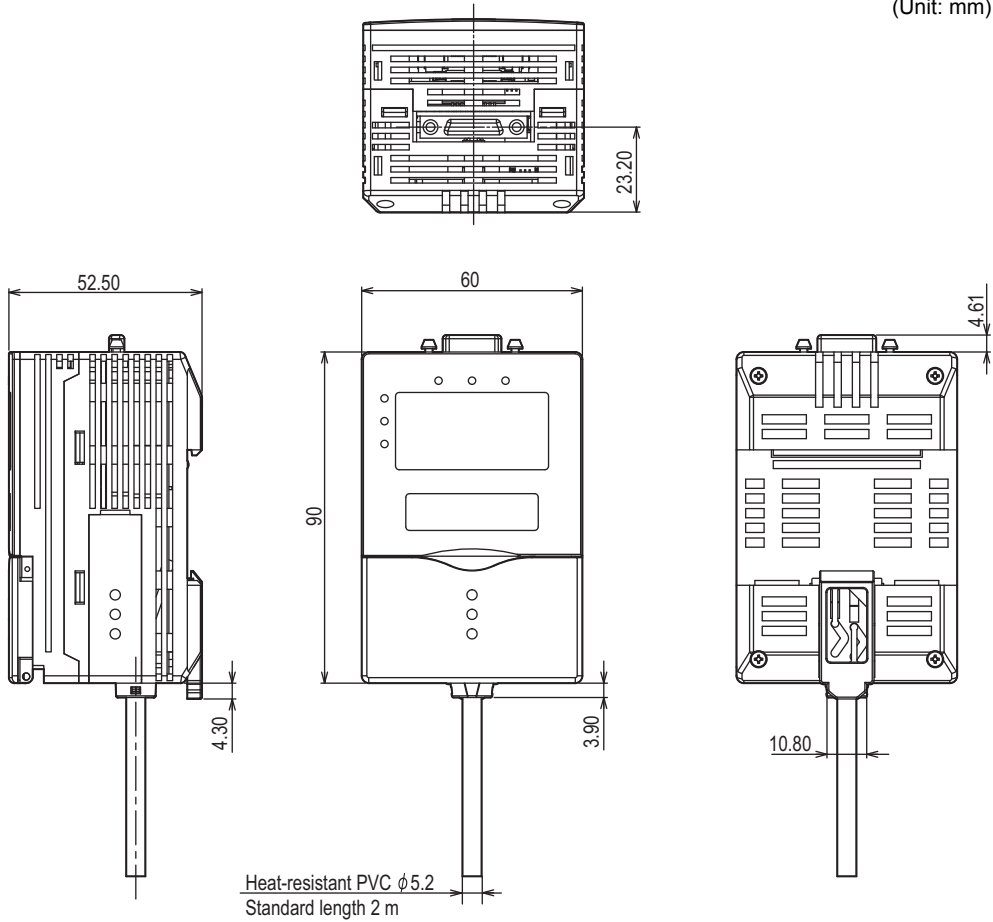



# Accessory

## Panel Mount Adapter

ZS-XPM1/XPM2

When mounting on a panel

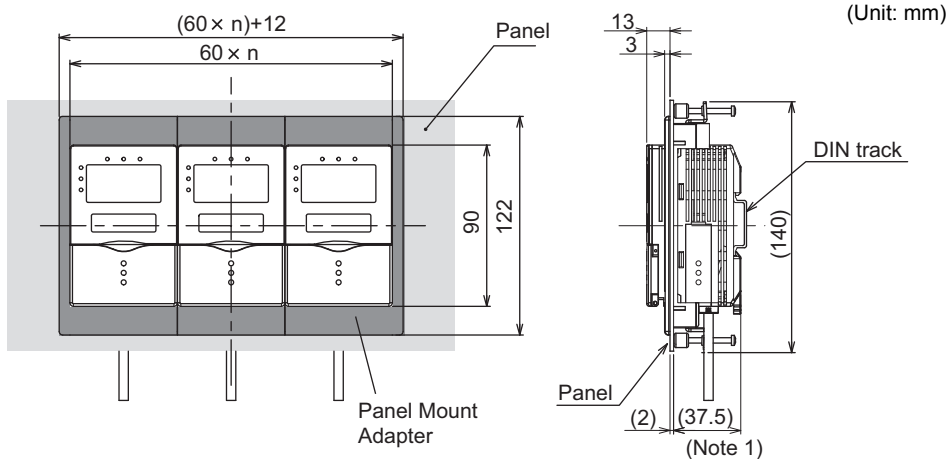

Note 1: Dimensions are shown for a panel thickness of 2.0 mm.

### Panel cutout dimensions

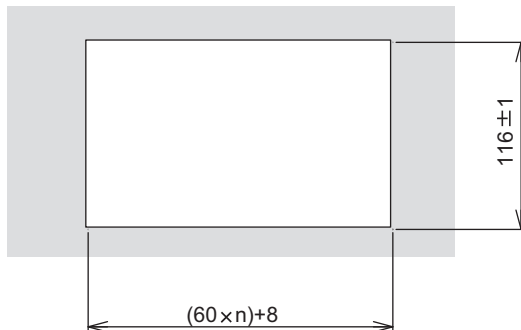

When mounting on a panel, attach a DIN track on the rear of a Panel Mount Adapter to reinforce it.

n: number of gang-mounted controllers (1 to 10)

Item	ZS-XPM1 (for 1st unit)	ZS-XPM2 (for 2nd unit onwards)
Appearance		
Applicable controller	ZS Series	
Vibration resistance (destructive)	10 to 150 Hz, 0.7-mm double amplitude, 80 min each in X, Y, and Z directions	
Shock resistance (destructive)	300 m/s <sup>2</sup> 3 times each in six directions (up/down, left/right, forward/backward)	
Materials	Polycarbonate (PC), etc.	
Weight	Approx. 50 g	

## Extension Cable

ZS-XC\_A/XC\_B/XC5BR

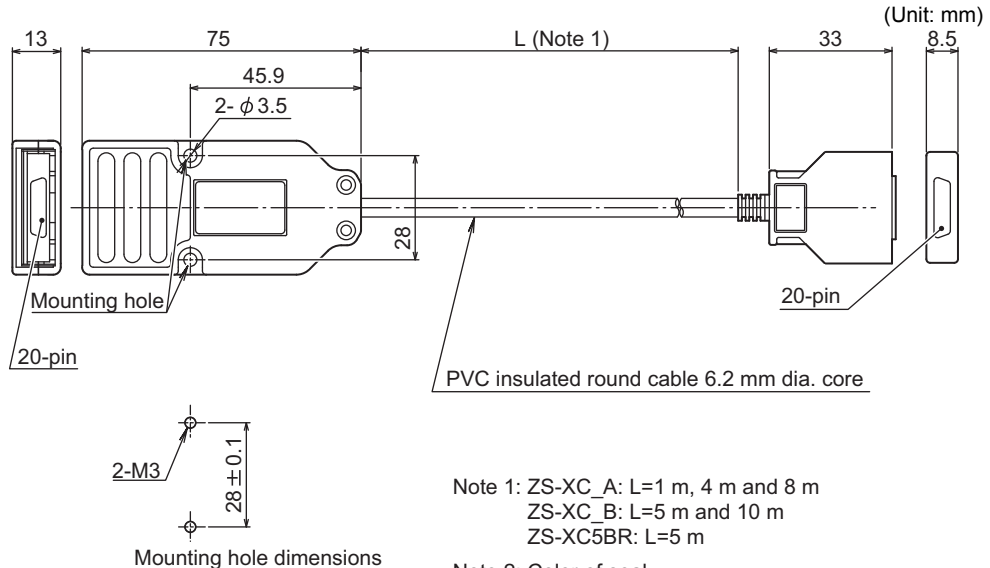

Item	ZS-XC1A	ZS-XC4A	ZS-XC8A	ZS-XC5B	ZS-XC10B	ZS-XC5BR
Applicable controller	ZS Series					
Applicable Sensor Head	ZS Series					
Ambient temperature	Operating: 0 to +50 °C, Storage: -15 to +60 °C (with no icing or condensation)					
Ambient humidity	Operating and storage: 35 % to 85 % (with no condensation)					
Connection method	Double-end connector					
Materials	Case: Polycarbonate (PC)					
Weight	Approx. 150 g	Approx. 320 g	Approx. 550 g	Approx. 350 g	Approx. 620 g	Approx. 350 g
Cable length	1 m	4 m	8 m	5 m	10 m	5 m

## Extension Cable (Long-Distance, Flexible Type)

### ■ extension cable

ZS-XC\_\_CR

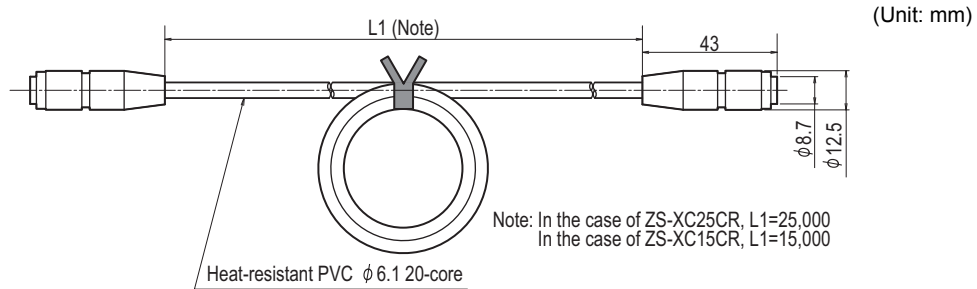

Item	ZS-XC25CR	ZS-XC15CR
Cable length	25 m	15 m
Applicable Sensor Head/Controller	ZS Series (*1)	
Ambient temperature	Operating: 0 to +50 °C, Storage: -15 to +60 °C (with no icing or condensation)	
Ambient humidity	Operating and storage: 35 % to 85 % (with no condensation)	
Vibration resistance (destructive)	10 to 150 Hz, 0.7-mm double amplitude, 80 min each in X, Y, and Z directions	
Shock resistance (destructive)	300 m/s <sup>2</sup> 3 times each in six directions (up/down, left/right, forward/backward)	
Materials	Cable sheath: PVC	
Weight (excluding packing materials and accessories)	Approx. 1.4 kg	Approx. 1.0 kg

(\*1) There are restrictions on the Sensor Head/controller you can connect. For details, contact your OMRON representative.

### ■ Cable for connecting a digital equalizer

ZS-XC02D

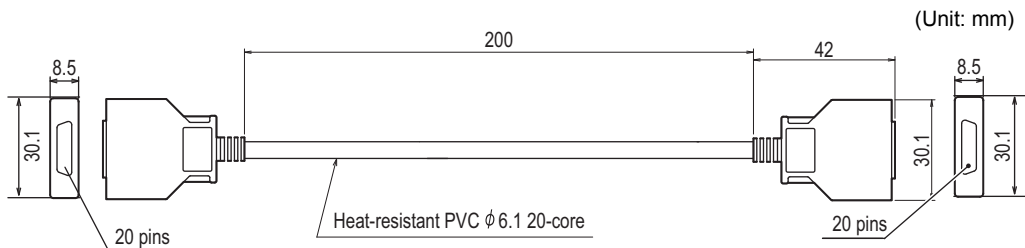

Item	ZS-XC02D
Applicable Sensor Head/Controller	ZS Series (*1)
Ambient temperature	Operating: 0 to +50 °C, Storage: -15 to +60 °C (with no icing or condensation)
Ambient humidity	Operating and storage: 35 % to 85 % (with no condensation)
Vibration resistance (destructive)	10 to 150 Hz, 0.7-mm double amplitude, 80 min each in X, Y, and Z directions
Shock resistance (destructive)	300 m/s <sup>2</sup> 3 times each in six directions (up/down, left/right, forward/backward)
Materials	Cable sheath: PVC
Weight (excluding packing materials and accessories)	Approx. 50 g

(\*1) There are restrictions on the Sensor Head/controller you can connect. For details, contact your OMRON representative.

## ■ Digital equalizer

ZS-XEQ

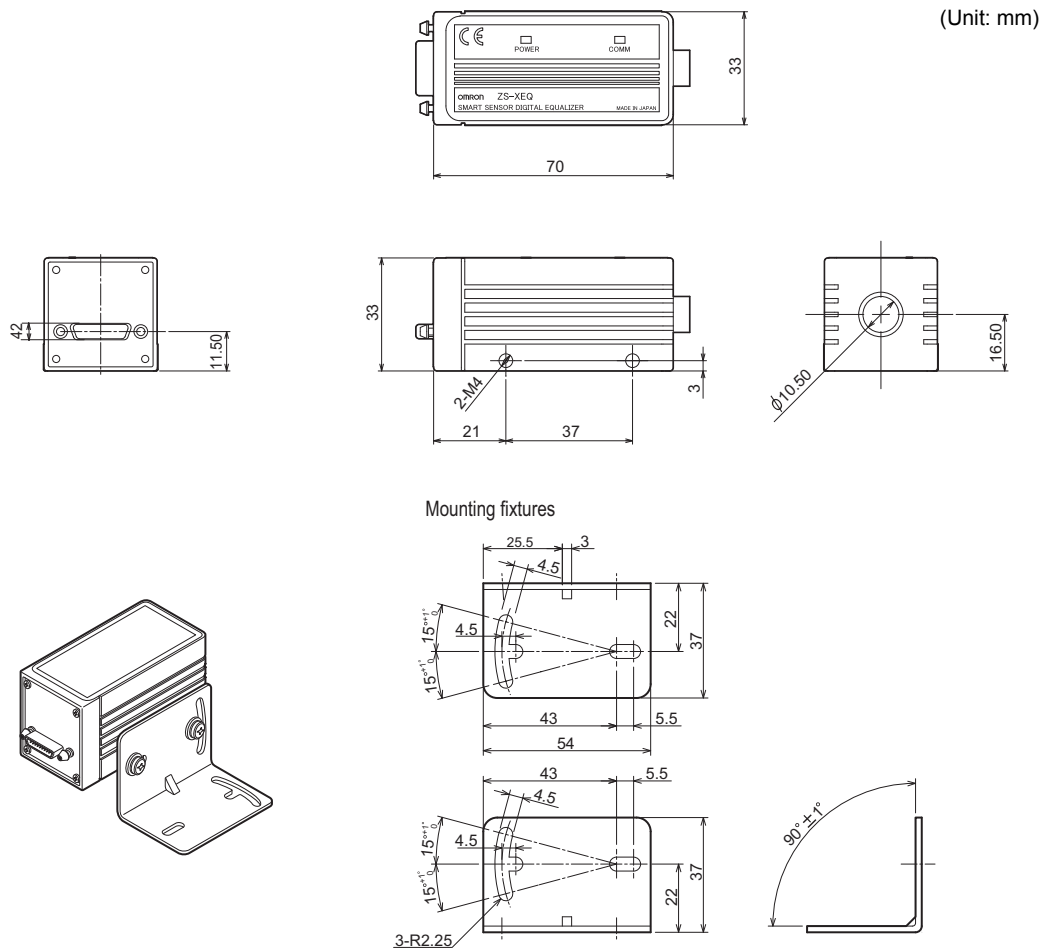

Item	ZS-XEQ
Applicable Sensor Head/Controller	ZS Series (*1)
Ambient temperature	Operating: 0 to +50 °C, Storage: -15 to +60 °C (with no icing or condensation)
Ambient humidity	Operating and storage: 35 % to 85 % (with no condensation)
Vibration resistance (destructive)	10 to 150 Hz, 0.7-mm double amplitude, 80 min each in X, Y, and Z directions
Shock resistance (destructive)	300 m/s <sup>2</sup> 3 times each in six directions (up/down, left/right, forward/backward)
Materials	Case: Aluminum die-cast
Degree of protection	IEC60529 IP20
Weight (excluding packing materials and accessories)	Approx. 120 g

(\*1) There are restrictions on the Sensor Head/controller you can connect. For details, contact your OMRON representative.

## RS-232C Cable

ZS-XPT2 (for connecting to programmable controller/programmable terminal)

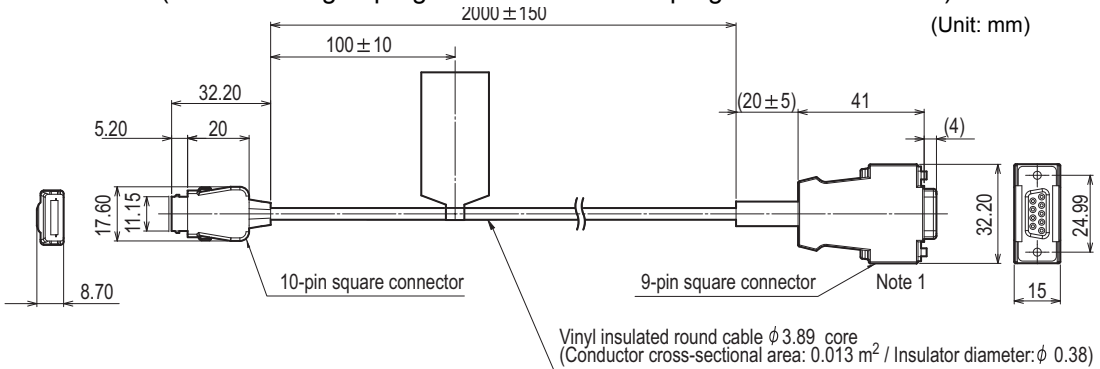

Note 1: Plug-type connector.  
Lock screw's metric screw thread(M2.6 × 0.45)

ZS-XRS2 (for connecting to a personal computer)

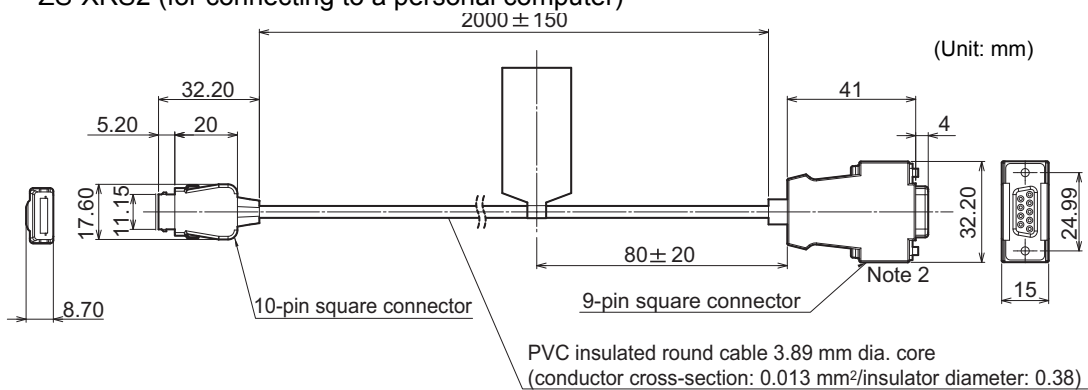

Note 2: Socket-type connector.  
Lock screw's metric screw thread(M2.6 × 0.45)

Item	ZS-XRS2	ZS-XPT2
Applicable controller	ZS Series	
Ambient temperature	Operating: 0 to +50 °C, Storage: -15 to +60 °C (with no icing or condensation)	
Ambient humidity	Operating and storage: 35 % to 85 % (with no condensation)	
Dialectic strength	1,000 VAC, 50/60 Hz for 1 min	
Insulation resistance (destructive)	100 M $\Omega$ (by 500 VDC megger)	
Vibration resistance (destructive)	10 to 150 Hz, 0.7-mm double amplitude, 80 min each in X, Y, and Z directions	
Shock resistance	300 m/s <sup>2</sup> 3 times each in six directions (up/down, left/right, forward/backward)	
Materials	Cable sheath: PVC	
Weight	Approx. 50 g	

## Control Link Unit

ZS-XCN

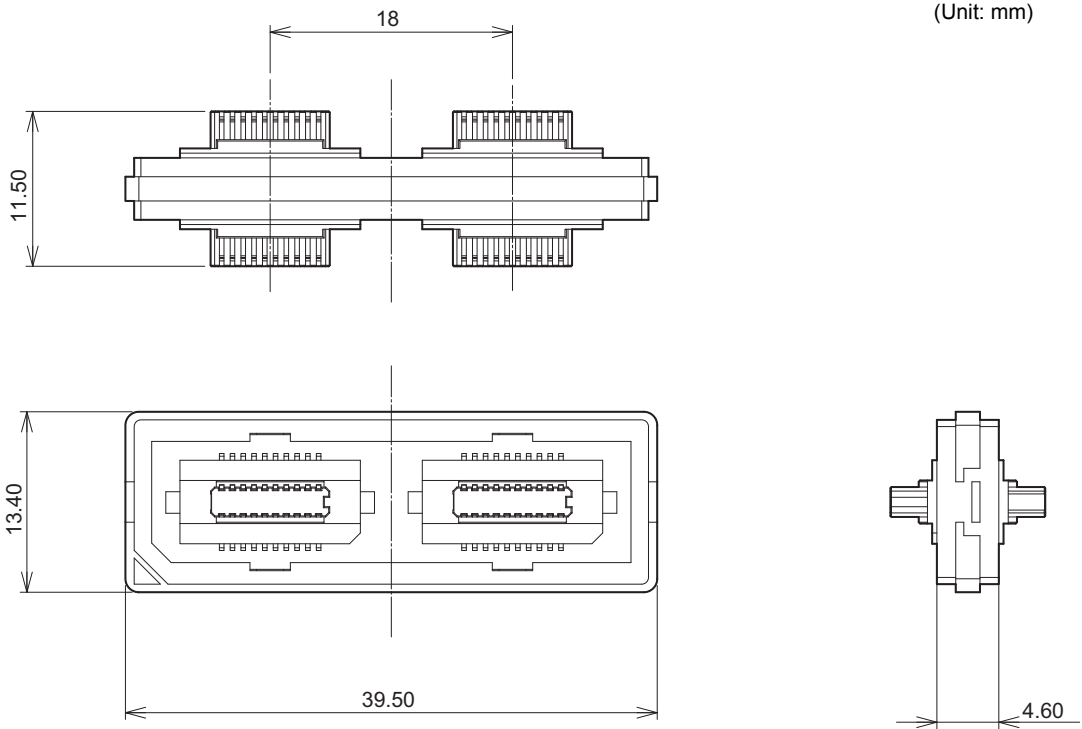

Item	ZS-XCN
Applicable controller	ZS Series
Ambient temperature	Operating: 0 to +50 °C, Storage: -15 to +60 °C (with no icing or condensation)
Ambient humidity	Operating and storage: 35 % to 85 % (with no condensation)
Vibration resistance (destructive)	10 to 150 Hz, 0.7-mm double amplitude, 80 min each in X, Y, and Z directions
Shock resistance (destructive)	300 m/s <sup>2</sup> 3 times each in six directions (up/down, left/right, forward/backward)
Materials	Polycarbonate (PC), etc.
Weight	Approx. 10 g

# Real-Time Parallel Output Unit

ZG-RPD11/RPD41

(Unit: mm)

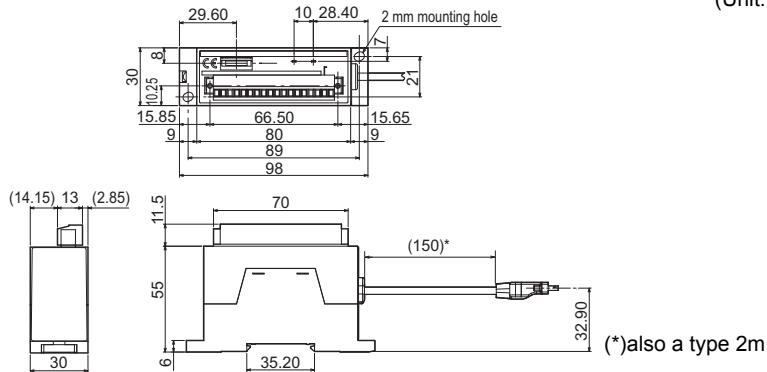

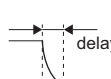
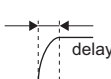
Item	ZG-RPD11	ZG -RPD41
I/O type	NPN Amplifier Unit	PNP Amplifier Unit
Data output system	16-bit parallel open collector output	
Data format	Measurement value data is converted to 40,000 stages of 16-bit binary data before output. (signal names: D0 to D15)	
Data update cycle	<p>Can be set as desired using integer multiples of the sampling cycle. The update cycle is determined by the following calculation formula:</p> <ul style="list-style-type: none"> <li>(update cycle) = (sampling cycle) × (update coefficient)</li> </ul> <p>The update coefficient parameter can be set by the user as an integer value within the range 1 to 100. (Ex. When the sampling cycle is 112 μs, the settable range becomes 112 μs to 11.2 ms.)</p>	
Synchronization signal	Synchronization signal for notifying data determination timing (signal name: GATE). 1-bit open collector output	
Parallel output	Signal name	<ul style="list-style-type: none"> <li>Binary output: signal name: D0 to D15 (total 16 bits)</li> <li>Gate output: signal name: GATE (total 16 bits)</li> </ul>
	Circuit specification	<p>NPN open-collector, 30 VDC max., 20 mA max., residual voltage 1.2 V or less, delay time at OFF → ON change: less than 0.5 μs (at 24 V, 20 mA)</p>  <p>PNP open-collector, 20 mA max., residual voltage 1.2 V or less, delay time at OFF → ON change: less than 0.5 μs (at 20 mA)</p> 
RS-232C	1 port, max. 115,200 bps	
Status indicators	<ul style="list-style-type: none"> <li>PWR indicator (lit color: green) → Lit when ZG-RPD is energized.</li> <li>ERR indicator (lit color: red) → Lit when an energizing current of 20 mA or more flows to 1 bit or more of the open collector output (data output: 16 bits, GATE: 1 bit)</li> </ul>	
Circuit internal power supply voltage	24 VDC and 3.3 VDC. Power supplied form ZS-HLDC_1 via exclusive connector.	
Current consumption	0.5 A or less. Total value including current consumption of ZS-HLDC_1	
Insulation resistance	Connected to ZS-HLDC_1, across all lead wires and controller case of the ZS-HLD-C_1: 20 MΩ (by 250 V megger)	
Dialectic strength	Connected to ZS-HLDC_1, across all lead wires and controller case of the ZS-HLD-C_1: 1000 VAC, 50/60Hz 1min	

Item	ZG-RPD11	ZG -RPD41
Vibration resistance (destructive)	10 to 150 Hz, 0.7-mm double amplitude, 80 min each in X, Y, and Z directions	
Shock resistance (destructive)	300 m/s <sup>2</sup> 3 times each in six directions (up/down, left/right, forward/backward)	
Ambient temperature	Operating: 0 to +50 °C, Storage: -15 to +60 °C (with no icing or condensation)	
Ambient humidity	Operating and storage: 35 % to 85 % (with no condensation)	
Materials	Case: ABS	
Weight	Approx. 130 g (excluding packing materials and accessories)	



# Section9

## APPENDIX

☒ Troubleshooting	9-2
☒ Error Messages and Countermeasures	9-3
☒ Safety Precautions for Using Laser Equipment	9-4
ZS-HLDS60/ZS-HLDS150	9-4
ZS-LD20/LD20S/LD40/LD50/LD50S/LD80/LD130/ LD200/LD350S/HLDS5/HLDS10	9-6
☒ Requirements from Regulations and Standards	9-7
Summary of Requirements to Manufactures	9-7
Summary of Requirements to User	9-11
Definitions of Laser Classification	9-14
☒ Updating Firmware	9-16
Flow of Updating Firmware	9-16
☒ Index	9-23

# Troubleshooting

This section describes countermeasures for temporary hardware problems. Check the malfunction in this section before sending the hardware for repair.

Problem	Probable cause and possible countermeasure	Pages
Device restarts during operation.	<ul style="list-style-type: none"> <li>• Is the power supply device connected correctly?</li> <li>• Does the power supply device conform to the power supply specifications (such as power supply voltage and current consumption)?</li> </ul>	p.1-3
Judgments are not output to external device.	<ul style="list-style-type: none"> <li>• Are all cables connected correctly?</li> <li>• Is the signal line disconnected?</li> <li>• Are reset inputs short-circuited?</li> <li>• Are the non-measurement settings in a clamped state, making the measurement impossible to perform?</li> </ul>	p.2-10 p.6-15
No input signal received.	<ul style="list-style-type: none"> <li>• Are all cables connected correctly?</li> <li>• Is the signal line disconnected?</li> </ul>	p.2-10
No communication with personal computer.	<ul style="list-style-type: none"> <li>• Is the USB cable connected correctly?</li> <li>• Is the RS-232 cable connected correctly?</li> <li>• Are other applications using the ports on the personal computer?</li> <li>• Do the communication conditions match between the personal computer and controller?</li> <li>• Has the USB driver been installed?</li> <li>• Is operation of the controller normal?</li> <li>• Are you using a personal computer that meets the operating environment?</li> </ul>	p.7-2
Strange linear output levels.	<ul style="list-style-type: none"> <li>• Is the voltage/current switch on the bottom of the Sensor Controller set to the correct position?</li> <li>• Has the correct selection (voltage/current) been made in the focus settings?</li> </ul> <p>Linear output levels can be fine-tuned.</p>	p.1-5 p.6-4
The main display remains on [----].	<ul style="list-style-type: none"> <li>• Has a timing input been made with the hold function enabled and the trigger type set to [EXT]?</li> <li>• If the hold function is enabled and the trigger type is [SELF-UP] or [SELF-DN], has the self-trigger level been set to an appropriate value?</li> </ul>	p.5-19
An abnormal distance is displayed when the object is clearly outside the measuring range.	<ul style="list-style-type: none"> <li>• This problem may occur due to the characteristics of the sensor. Make sure that the distance to the sensing object is appropriate.</li> <li>• This problem is sometimes rectified by setting the emitted light amount to a fixed distance.</li> </ul>	p.5-8
The measured values fluctuate and are not stable depending on day and time.	<ul style="list-style-type: none"> <li>• This problem may be due to temperature characteristics. Execute zero reset periodically using the standard object to correct this problem.</li> </ul>	p.4-6
Laser is not emitted.	<ul style="list-style-type: none"> <li>• Is the LD_OFF input line short-circuited?</li> </ul>	p.2-10

# Error Messages and Countermeasures

## ■ When [Error] Is Displayed on the Main Display

Display Details		Cause	Countermeasure
LCD screen (upper section)	Overcurrent	Individual or groups of judgment outputs are short-circuited.	Cancel the load short-circuit.
	Dark Error	Insufficient received light amount from workpiece. Distance measurement error.	For a workpiece with regular reflection (glass) <ul style="list-style-type: none"> <li>• Check the angle at which the Sensor Head is attached.</li> </ul> For a workpiece with diffuse reflection <ul style="list-style-type: none"> <li>• Set to High-Sensitivity mode.</li> <li>• Set the gain setting to 2 or higher.</li> </ul>
	Bright Error	Saturated received light amount from the workpiece. Distance measurement error.	<ul style="list-style-type: none"> <li>• Set to High-Speed mode.</li> <li>• Set the gain setting to 1.</li> </ul>
	Measure Error	When [NORMAL], [PCB], and [MIRROR] are set for the measurement object, the number of surfaces currently being measured is 2 or more. Alternatively, when [GLASS] is set for the measurement object, the number of surfaces currently being measured is 4 or more.	For a workpiece with regular reflection (glass) <ul style="list-style-type: none"> <li>• Check the angle at which the Sensor Head is attached.</li> </ul> For a workpiece with diffuse reflection <ul style="list-style-type: none"> <li>• Set to GLASS mode.</li> <li>• Using SmartMonitor ZS, set the measurement area to the surface you want to measure.</li> </ul>

## ■ When all digits on the main display and sub-display blink

Display Details		Cause	Countermeasure
LCD screen	SYSTEM ERROR HEAD COM (EEPROM)	The Sensor Head is not connected.	Connect the Sensor Head.
	SYSTEM ERROR BANK DATA	Bank data in the Sensor Controller in error	Hold the UP key down for 3 seconds, and then hold the DOWN key down for 3 seconds. The sensor is turned ON again and restored after the device is initialized.
	SYSTEM ERROR MAIN COM	Internal error	Turn the Controller ON again.

## ■ Others

Display Details		Cause	Countermeasure
LCD upper section	Disp range Error	The measurement result exceeds the number of displayed digits.	Change the decimal point digit setting.  p.5-25
Main display	—	The sensor is standing by for measurement.	When hold is set, start sampling and apply the hold value.

## Safety Precautions for Using Laser Equipment

Regarding laser devices, classes that indicate dangerous levels and various safety standards for dangers are stipulated depending on the country of use. Follow respective standards and implement safety measures.

Class classification

Standards and Class Classification (*1)		Maximum Output of Laser Beam
JIS C 6802 (Japan) EN60825/IEC60825-1 (Europe)	FDA (the United States)	
Class2	Class II	1 mW or less

(\*1) Because the safety standards differ according to each country, when you use the Sensor Controller in a country other than Japan, Europe, and the United States, please check the safety regulations and standards for lasers of the relevant country.

### ZS-HLDS60/ZS-HLDS150

#### ■ Warning Labels

On the head unit, a label that describes the warning in Japanese is attached. When you use the Sensor Controller in a country other than Japan, The label must be replaced by suitable for the area ones supplied with product.

#### ● When you use a Sensor Controller in the United States

This product is subject to the U.S. FDA (Food and Drug Administration) laser regulations and is classified to Class II by the IEC60825-1: 2007 standard according to the provision of laser Notice No.50 of the FDA standard.

HLDS60/HLDS150 have been already applied for CDRH (Center for Devices and Radiological Health).

Products relevant to FDA are supplied with labels that conform to FDA regulations. When these products are used in the U.S., replace the warning label on the sensor body with the FDA labels (supplied) referring to the figure below. Make sure that the labels are affixed at the correct locations as indicated.

The ZS-HLD\_\_\_ is intended to be fitted into a system as a terminal device. Follow the following technical standards when fitting in the device.

\* 21CFR 1040.10/1040.11/IEC60825-1: 2007

Compliance Guide for Laser Products

Warning label



Certification label

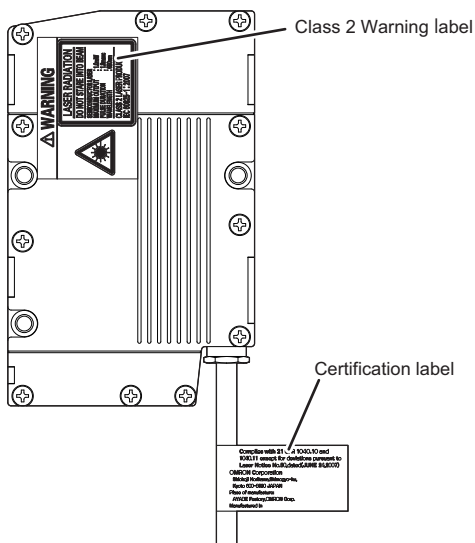
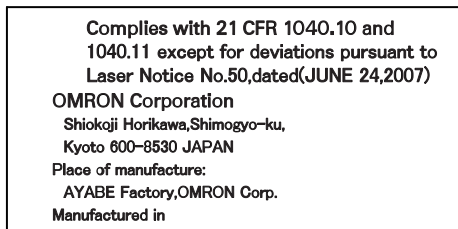

● Usage in China

This product is classified into class 2 by the GB7247.1: 2012 (IEC60825-1: 2007) standard. When using in China, warning labels must be replaced by Chinese ones supplied with the product.



● Usage in a country other than U.S. and China.

For countries other than Japan, U.S., and China, warning labels must be replaced by suitable for the area ones supplied with the product.

EN60825-1 is provided for products used in Europe, and the content of this standard differs. The ZS-HLDS60/150 is categorized as Class 2 device as stipulated in EN60825-1 (IEC60825-1): 2014.



# ZS-LD20/LD20S/LD40/LD50/LD50S/LD80/LD130/LD200/ LD350S/HLDS5/HLDS10

## ■ Warning Labels

On the head unit, a label that describes the warning in Japanese is attached. When you use the Sensor Controller in a country other than Japan, replace the label with the English label that is provided in the head unit.

### ● When you use a Sensor Controller in the United States

This product is subject to the U.S. FDA (Food and Drug Administration) laser regulations and is classified to Class II stipulated in these regulations.

ZS-LD20/LD20S/LD40/LD50/LD50S/LD80/LD130/LD200/LD350S/HLDS5/HLDS10 have been already applied for CDRH (Center for Devices and Radiological Health).

Products relevant to FDA are supplied with labels that conform to FDA regulations. When these products are used in the U.S., replace the warning label on the sensor body with the FDA labels (supplied) referring to the figure below. Make sure that the labels are affixed at the correct locations as indicated.

The ZS-HLD\_\_ is intended to be fitted into a system as a terminal device. Follow the following technical standards when fitting in the device.

\* FDA: 21CFR 1040.10 and 1040.11

Compliance Guide for Laser Products

Laser emitter section label



Warning label



Laser emitter section label

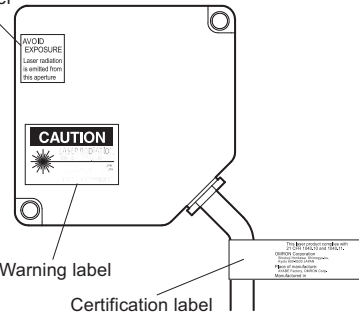

Certification label



### ● Exporting to a country other than the U.S.

For countries other than Japan and the U.S., warning labels must be replaced by English ones (supplied with the product).

ZS-LD\_\_/\_/HLDS5T/HLDS10

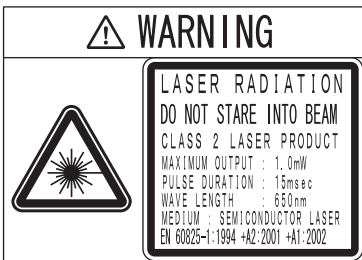

# Requirements from Regulations and Standards

## Summary of Requirements to Manufactures

### ■ For Europe

EN 60825-1 “Safety of Laser Products, Equipment Classification, Requirements and User’s Guide”

Summary of Manufacturer’s Requirements

Requirements subclause	Classification						
	Class 1	Class 1M	Class 2	Class 2M	Class 3R	Class 3B	Class 4
Description of hazard class	Safe under reasonably foreseeable conditions	As for Class 1 except may be hazardous if user employs optics	Low power; eye protection normally afforded by aversion responses	As for Class 2 except may be more hazardous if user employs optics	Direct intra-beam viewing may be hazardous	Direct intra-beam viewing normally hazardous	High power; diffuse reflections may be hazardous
Protective housing	Required for each laser product; limits access necessary for performance of functions of the products						
Safety interlock in protective housing	Designed to prevent removal of the panel until accessible emission values are below that for Class 3R				Designed to prevent removal of the panel until accessible emission values are below that for Class 3B		
Remote control	Not required					Permits easy addition of external interlock in laser installation	
Key control	Not required					Laser inoperative when key is removed	
Emission warning device	Not required				Give audible or visible warning when laser is switched on or if capacitor bank of pulsed laser is being charged. For Class 3R only, applies invisible radiation is emitted		
Attenuator	Not required					Give means beside the On/Off switch to temporarily to block beam	
Location controls	Not required				Controls so located that there is no danger of exposure to AEL above Classes 1 or 2 when adjustments are made		
Viewing optics	Not required	Emission from all viewing systems must be below Class 1M AEL					
Scanning	Scan failure shall not cause product to exceed its classification						
Class label	Required wording		Figures A required wording				
Aperture label	Not required				Specified wording required		
Service entry label	Required as appropriate to the class of accessible radiation						
Override interlock label	Required under certain conditions as appropriate to the class of laser used						

## Section9 Requirements from Regulations and Standards

Requirements subclause	Classification						
	Class 1	Class 1M	Class 2	Class 2M	Class 3R	Class 3B	Class 4
Wavelength range label	Required for certain wavelength ranges						
LED label	Make required word substitutions for LED products						
User information	Operation manuals must contain instructions for safe use. Additional requirement apply for Class 1M and Class 2M						
Purchasing and service information	Promotion brochures must specify product classification; service manuals must contain safety information						

- Note:** 1. This table is intended to provide a convenient summary of requirements. See text of this standard for complete requirements.  
 2. For the safety medical laser products, IEC 60601-2-22 applies  
 3. AEL: Accessible Emission Limit  
 The maximum accessible emission level permitted within a particular class. For your reference, see ANSI Z136.1-1993, Section 2.

Symbol and border: black  
Background: yellow

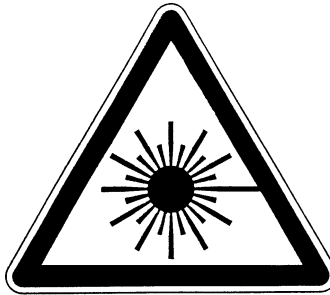

**Figure A Warning label - Hazard symbol**

Legend and border: black  
Background: yellow



**■ For U.S.A**

FDA (Compliance Guide for Laser Products, 1985, according to 21 CFR1040.10)

Requirements	Class (see note 1)					
	I	Ila	II	IIla	IIlb	IV
<b>Performance (all laser products)</b>						
Protective housing	R (see note 2)	R (see note 2)	R (see note 2)	R (see note 2)	R (see note 2)	R (see note 2)
Safety interlock	R (see notes 3,4)	R (see notes 3,4)	R (see notes 3,4)	R (see notes 3,4)	R (see notes 3,4)	R (see notes 3,4)
Location of controls	N/A	R	R		R	R
Viewing optics	R	R	R	R	R	R
Scanning safeguard	R	R	R	R	R	R
<b>Performance (laser systems)</b>						
Remote control connector	N/A	N/A	N/A	N/A	R	R
Key control	N/A	N/A	N/A	N/A	R	R
Emission indicator	N/A	N/A	R	R	R (see note 10)	R (see note 10)
Beam attenuator	N/A	N/A	R	R	R	R
Reset	N/A	N/A	N/A	N/A	N/A	R (see note 13)
<b>Performance (specific purpose products)</b>						
Medical	S	S	S	S (see note 8)	S (see note 8)	S (see note 8)
Surveying, leveling, alignment	S	S	S	S	NP	NP
Demonstration	S	S	S	S	S (see note 11)	(see note 11)
<b>Labeling (all laser products)</b>						
Certification & identification	R	R	R	R	R	R
Protective housing	D (see note 5)	D (see note 5)	D (see note 5)	D (see note 5)	D (see note 5)	D (see note 5)
Aperture	N/A	N/A	R	R	R	R
Class warning	N/A	R (see note 6)	R (see note 7)	R (see note 9)	R (see note 12)	R (see note 12)
<b>Information (all laser products)</b>						
User information	R	R	R	R	R	R
Product literature	N/A	R	R	R	R	R
Service information	R	R	R	R	R	R

**Abbreviations:**

**R:** Required.

**N/A:** Not applicable.

**S:** Requirements: Same as for other products of that Class. Also see footnotes.

**NP:** Not permitted.

**D:** Depends on level of interior radiation.

## Section9 Requirements from Regulations and Standards

### Footnotes:

**Note 1:** Based on highest level accessible during operation.

**Note 2:** Required wherever & whenever human access to laser radiation above Class I limits is not needed for product to perform its function.

**Note 3:** Required for protective housings opened during operation or maintenance, if human access thus gained is not always necessary when housing is open.

**Note 4:** Interlock requirements vary according to Class of internal radiation.

**Note 5:** Wording depends on level & wavelength of laser radiation within protective housing.

**Note 6:** Warning statement label.

**Note 7:** CAUTION logotype.

**Note 8:** Requires means to measure level of laser radiation intended to irradiate the body.

**Note 9:** CAUTION if  $2.5 \text{ mW cm}^2$  or less, DANGER if greater than  $2.5 \text{ mW cm}^2$ .

**Note 10:** Delay required between indication & emission.

**Note 11:** Variance required for Class IIb or IV demonstration laser products and light shows.

**Note 12:** DANGER logotype.

**Note 13:** Required after August 20, 1986.

## Summary of Requirements to User

### ■ For Europe

EN 60825-1

Requirements subclause	Classification						
	Class 1	Class 1M	Class 2	Class 2M	Class 3R	Class 3B	Class 4
Laser safety officer	Not required but recommended for applications that involve direct viewing of the laser beam				Not required for visible emission Required for non-visible emission	Required	
Remote interlock	Not required					Connect to room or door circuits	
Key control	Not required					Remove key when not in use	
Beam attenuator	Not required					When in use prevents inadvertent exposure	
Emission indicator device	Not required				Indicates laser is energized for non-visible wavelengths	Indicates laser is energized	
Warning signs	Not required					Follow precautions on warning signs	
Beam path	Not required	Class 1M as for Class 3B (see note 2)	Not required	Class 2M as for Class3B (see note 3)	Terminate beam at end of useful length		
Specular reflection	No requirements	Class 1M as for Class 3B (see note 2)	No requirements	Class 2M as for Class3B (see note 3)	Prevent unintentional reflections		
Eye protection	No requirements				Not required for visible emission Required for non-visible emission	Required if engineering and administrative procedures not practicable and MPE exceeded	
Protective clothing	No requirements					Sometimes required	Specific requirements
Training	No requirements	Class 1M as for Class 3R (see note 2)	No requirements	Class 2M as for Class3R (see note 3)	Required for all operator and maintenance personnel		

- Note:** 1. This table is intended to provide a convenient summary of requirements. See text of this standard for complete precautions.  
 2. Class 1M laser products that failed condition 1 of table10 of the standard. Not required for Class 1M laser products that failed condition 2 of table10 of the standard. See the text for details.  
 3. Class 2M laser products that failed condition 1 of table10 of the standard. Not required for Class 2M laser products that failed condition 2 of table10 of the standard. See the text for details.

### ■ For U.S.A

## Section9 Requirements from Regulations and Standards

ANSI Z136.1:1993 “American National Standard for the Safe Use of Lasers” Control Measures for the Four Laser Classes

Control measures	Classification					
	1	2a	2	3a	3b	4
Engineering Controls	1	2a	2	3a	3b	4
Protective Housing (4.3.1)	X	X	X	X	X	X
Without Protective Housing (4.3.1.1)	LSO (see note 2) shall establish Alternate Controls					
Interlocks on Protective Housing (4.3.2)	☆	☆	☆	☆	X	X
Service Access Panel (4.3.3)	☆	☆	☆	☆	X	X
Key Control (4.3.4)	---	---	---	---	•	X
Viewing Portals (4.3.5.1)	---	---	MPE	MPE	MPE	MPE
Collecting Optics (4.3.5.2)	MPE	MPE	MPE	MPE	MPE	MPE
Totally Open Beam Path (4.3.6.1)	---	---	---	---	X NHZ	X NHZ
Limited Open Beam Path (4.3.6.2)	---	---	---	---	X NHZ	X NHZ
Enclosed Beam Path (4.3.6.3)	None is required if 4.3.1 and 4.3.2 fulfilled					
Remote Interlock Connector (4.3.7)	---	---	---	---	•	X
Beam Stop or Attenuator (4.3.8)	---	---	---	---	•	X
Activation Warning Systems (4.3.9)	---	---	---	---	•	X
Emission Delay (4.3.9.1)	---	---	---	---	---	X
Indoor Laser Controlled Area (4.3.10)	---	---	---	---	X NHZ	X NHZ
Class 3b Laser Controlled Area (4.3.10.1)	---	---	---	---	X	---
Class 4 Laser Controlled Area (4.3.10.2)	---	---	---	---	---	X
Laser Outdoor Controls (4.3.11)	---	---	---	---	X NHZ	X NHZ
Laser in Navigable Airspace (4.3.11.2)	---	---	---	•	•	•
Temporary Laser Controlled Area (4.3.12)	☆ MPE	☆ MPE	☆ MPE	☆ MPE	---	---
Remote Firing & Monitoring (4.3.13)	---	---	---	---	---	•
Labels (4.3.14 and 4.7)	X	X	X	X	X	X
Area Posting (4.3.15)	---	---	---	•	X NHZ	X NHZ
Administrative & Procedural Controls	1	2a	2	3a	3b	4
Standard Operating Procedures (4.4.1)	---	---	---	---	•	X
Output Emission Limitations (4.4.2)	---	---	---	LSO Determination		
Education and Training (4.4.3)	---	---	•	•	X	X
Authorized Personnel (4.4.4)	---	---	---	---	X	X
Alignment Procedures (4.4.5)	---	---	X	X	X	X
Protective Equipment (4.4.6)	---	---	---	---	•	X
Spectator (4.4.7)	---	---	---	---	•	X
Service Personnel (4.4.8)	☆ MPE	☆ MPE	☆ MPE	☆ MPE	X	X
Demonstration with General Public (4.5.1)	MPE+	---	X	X	X	X
Laser Optical Fiber Systems (4.5.2)	MPE	MPE	MPE	MPE	X	X

Control measures	Classification					
Laser Robotic Installations (4.5.3)	---	---	---	---	X NHZ	X NHZ
Eye Protection (4.6.2)	---	---	---	---	• MPE	X MPE
Protective Windows (4.6.3)	---	---	---	---	X NHZ	X NHZ
Protective Barriers and Curtains (4.6.4)	---	---	---	---	•	•
Skin Protection (4.6.5)	---	---	---	---	X MPE	X MPE
Other Protective Equipment (4.6.5)	Use may be required					
Warning Signs and Labels (4.7) (Design Requirements)	---	---	•	•	X NHZ	X NHZ
Service and Repairs (4.8)	LSO Determination					
Modification of Laser Systems (4.9)	LSO Determination					

**Note:** 1. LEGEND

- X: Shall
- : Should
- : No requirement
- ☆: Shall if enclosed Class 3b or Class 4
- MPE: Shall if MPE is exceeded
- NHZ: Nominal Hazard Zone analysis required
- +: Applicable only to UV and IR Lasers (4.5.1.2)

2. LSO: Laser Safety Officer

An individual shall be designated the Laser Safety Officer with the authority and responsibility to monitor and enforce the control of laser hazards, and to effect the knowledgeable evaluation and control of laser hazards. For your reference, see ANSI Z136.1993, Section 1.3.

## Definitions of Laser Classification

### ■ For Europe

Laser Product Classifications

EN

Class	Description
Class 1	Lasers which are safe under reasonably foreseeable conditions of operation.
Class 2	Lasers emitting visible radiation in the wavelength range from 400 nm to 700 nm. Eye protection is normally afforded by aversion responses including the blink reflex.
Class 3A	Lasers which are safe for viewing with the unaided eye. For laser emitting in the wavelength range from 400 nm to 700 nm, protection is afforded by aversion responses including the blink reflex. For other wavelengths the hazard to the unaided eye is no greater than for Class 1. Direct intrabeam viewing of Class 3A lasers with optical aides (e.g., binoculars, telescopes, microscopes) may be hazardous.
Class 3B	Direct intrabeam viewing of these lasers is always hazardous. Viewing diffuse reflections is normally safe (see note).
Class 4	Lasers which are also capable of producing hazardous diffuse reflections. They may cause skin injuries and could also constitute a fire hazard. Their use requires extreme caution.

**Note:** Conditions for safe viewing of diffuse reflections for Class 3B visible lasers are: minimum viewing distance of 13 cm between screen and cornea and a maximum viewing time of 10 s. Other viewing conditions require a comparison of the diffuse reflection exposure with the MPE.

### ■ For U.S.A

Comparison of Classifications between FDA and ANSI

Class	FDA definition	ANSI description
Class I/1	Limits applicable to devices that have emissions in the ultraviolet, visible, and infrared spectra, and limits below which biological hazards have not been established.	A Class 1 laser is considered to be incapable of producing damaging radiation levels during operation and maintenance and is, therefore, exempt from any control measures or other forms of surveillance.
Class IIa/2a	Limits applicable to products whose visible emission does not exceed Class I limits for emission durations of 1,000 seconds or less and are not intended for viewing.	Class 2 lasers are divided into two subclasses, 2 and 2a. A Class 2 laser emits in the visible portion of the spectrum (0.4 to 0.7 $\mu\text{m}$ ) and eye protection is normally afforded by the aversion response including the blink reflex.
Class II/2	Limits applicable to products that have emissions in the visible spectrum (400 to 710 nm) for emission durations in excess of 0.25 second, providing that emissions for other durations and/or wavelengths do not exceed the Class I limits. Class II products are considered hazardous for direct long-term ocular exposure.	

Class	FDA definition	ANSI description
Class IIIa/3a	Limits to products that have emissions in the visible spectrum and that have beams where the total collectable radiant power does not exceed 5 milliwatts.	Class 3 lasers are divided into two sub-classes, 3a and 3b. A Class 3 laser may be hazardous under direct and specular reflection viewing conditions, but the diffuse reflection is usually not a hazard.
Class IIIb/3b	Limits applicable to devices that emit in the ultraviolet, visible, and infrared spectra. Class IIIb products include laser systems ranging from 5 to 500 milliwatts in the visible spectrum. Class IIIb emission levels are ocular hazards for direct exposure throughout the range of the Class, and skin hazards at the higher levels of the Class.	
Class IV/4	Exceeding the limits of Class IIIb and are a hazard for scattered reflection as well as for direct exposure.	A Class 4 laser is a hazard to the eye or skin from the direct beam and sometimes from a diffuse reflection and also can be a fire hazard. Class 4 lasers may also produce laser-generated air contaminants and hazardous plasma radiation.

## Updating Firmware

This section describes how to update the firmware of ZS Series Controllers (such as ZS-HLDC/ZS-MDC). Use Warp Engine ZS to update the firmware. Warp Engine ZS is automatically installed when SmartMonitor ZS is installed.

For the file for updating, please contact your OMRON representative.



- While updating, do not turn off the power of the controller. The controller will not start normally.
- To install the USB driver, log on as an Administrator or a user with system access rights.

### Flow of Updating Firmware

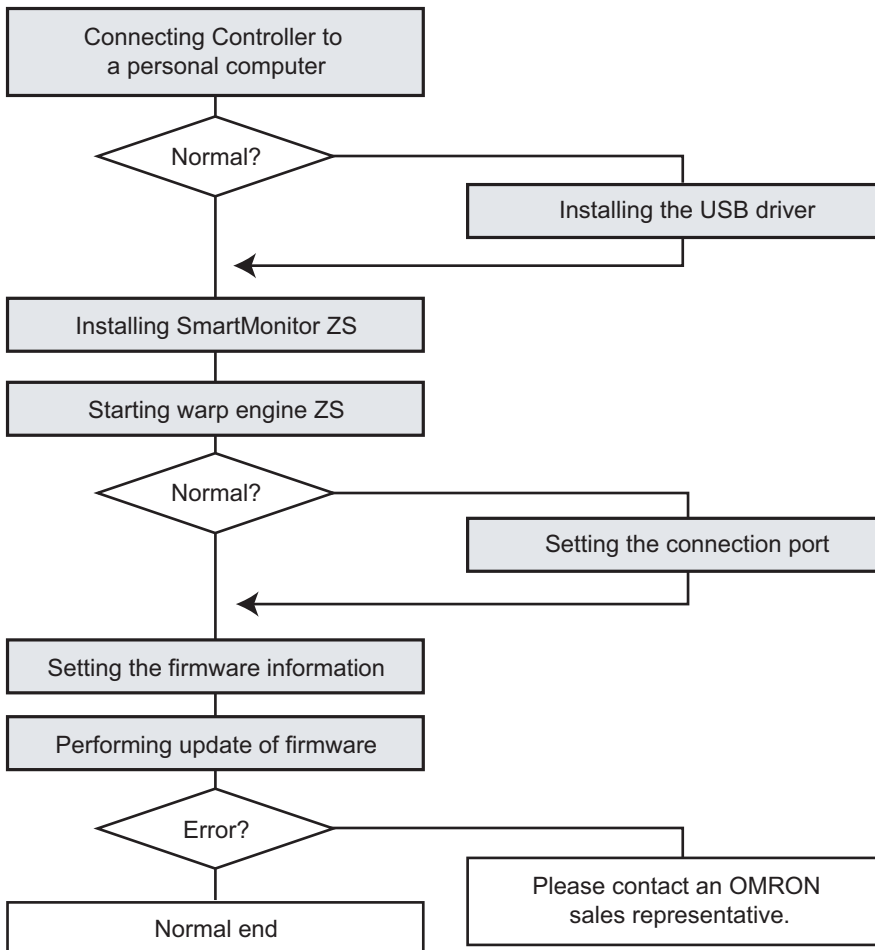



## Connecting the Controller to a Personal Computer

### 1. Connect the controller to the personal computer by the USB cable.

The USB driver must be installed when the controller is connected to the personal computer for the first time.

 Installing the USB driver p.2-16

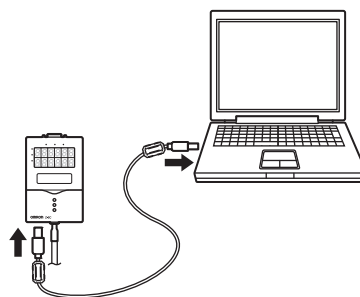

### 2. Turn on the power of the controller.



- Make sure that the power of the controller is connected securely. When the power is turned off while updating, the controller breaks down and does not run normally.
- Make sure that you turn on the power of the controller only (when it is not connected to other controllers). If you connect two or more controllers, Warp Engine ZS does not start.

## Installing SmartMonitor ZS

### 3. Install SmartMonitor ZS to a personal computer.

Warp Engine ZS that is used for updating the firmware will be simultaneously installed.

 Installing SmartMonitor ZS p.2-15

## Starting Warp Engine ZS



- Start Warp Engine ZS only when the personal computer recognizes the controller normally.
- When you start up ZS-MDC on its own, an error occurs in the controller. However, Warp Engine ZS should be started up in this state.

4. Select [Programs]-[OMRON]-[SmartMonitorZS3]-[WarpEngineZS] from the Windows [Start] menu.

The [WarpEngineZS] screen is displayed.

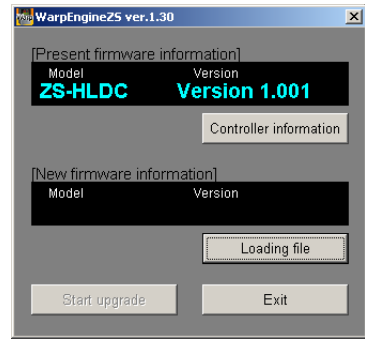

When the startup of Warp Engine ZS fails, the following screen is displayed after a message appears. Go to “Set the connection port”.

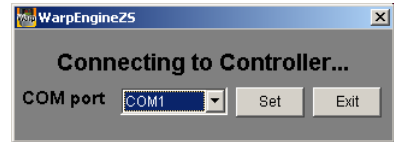

#### Setting the firmware information

5. Click the [Controller information] button as required.

The model and version of the controller that is being connected currently are displayed.

6. Click the [Loading] button and select the file in which you want to write.

The model and version of the controller that is held in the file are displayed.

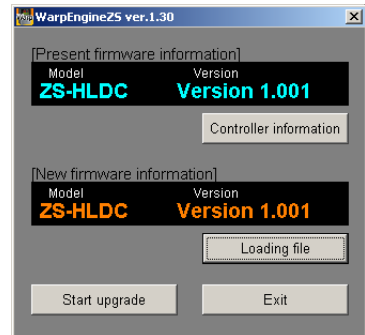

#### Performing Update of Firmware

7. Click the [Start upgrade] button in the displayed [WarpEngineZS] screen.

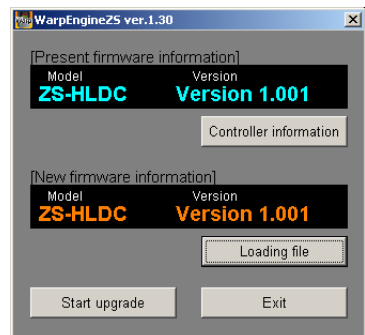

A message indicating the start of update appears.



If the message “the model is not the same” appears when you click the [Start upgrade] button, it means that the model of the connected controller and the model information in the specified file do not match. In this case, do not perform update. The controller will break down and will not start normally thereafter.

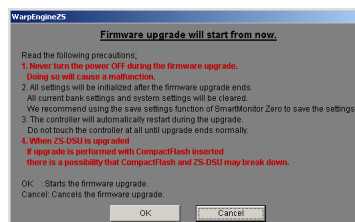

## 8. Check the contents of the message and click the [OK] button.

Update of the firmware will start.

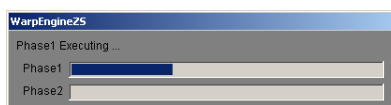

The progress status is displayed during the processing of update. Wait until the message box indicating that the update has finished normally appears (it takes a few minutes to complete the update).



- An error may occur on the controller during update; however, please wait.
- If the progress bar stops while update is being performed, or update does not finish normally even after 10 minutes, there is a possibility that update may have failed. In this case, contact an OMRON sales representative about the firmware version before update and the one in the write file.

## 9. After update completes, the following message appears. Follow the instructions on the screen and perform the operations.

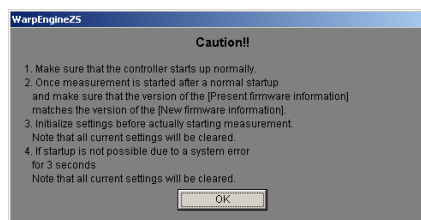

To complete the update of firmware, you need to initialize the controller. If the controller could not be initialized automatically from Warp Engine ZS, manually initialize it as described in steps 3 and 4. If the controller is initialized automatically, steps 3 and 4 are not displayed.

## 10. After you check the message, click the [OK] button.

## ■ Setting the Connection Port

When the startup of Warp Engine ZS fails, the following screen is displayed after a message appears.



1. Right-click [PC] on the Windows desktop and click [Properties].
2. Click [Device Manager].  
The [Device Manager] screen is displayed.

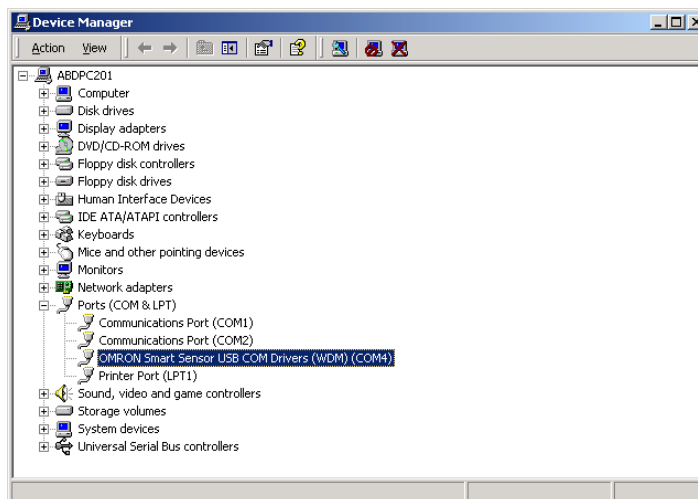

3. Open [Port COM/LPT], and check the COM number in [OMRON Smart Sensor USB COM Drivers (WDM) (COMxx)].  
The (COMxx) part indicates the connection port for the controller.
4. Select the connection port for the controller in [COM Port] and click the [Set] button.  
Warp Engine ZS will start.

MEMO



## Index

**Numerics**

0RESET MEMORY	5-23
1SHOT	6-8

**A**

absolute distance display	4-2
ADJUST	6-5
AUTO	5-8
AUTOOFF	5-26
AVERAGE	5-18
FILTER	5-13
MEASURE	5-24

**B**

backlight	5-26
bank	4-10
CLEAR	5-29
MODE	5-28
switching	4-11
BOTTOM	
hold types	5-18
MEASURE	5-24
BUSY output	2-11

**C**

CHANGE	4-11
characteristic points	5-24
CLAMP	6-15
COM	7-4, 7-6
CONNECT	6-16
control keys	4-2, 5-2
controller link unit	
specifications and external di-	
mensions	8-44
coupler	1-6
current display	4-2
CUSTOM	5-7, 5-25
CYCLE	5-27, 6-14

**D**

DELAY	5-21
DIFF	5-13
DIFFUSE	5-8
DIGITAL	7-7
Digital Display	
CUSTOM	5-25
digital output	7-7
DIRECT IN	4-7
DOT	5-25

**E**

ECO	5-25
emitted light amount display	4-2
emitter section	1-4
ENABLE	
indicator	1-5
OUTPUT	2-10
EXPOSE	5-7
Extension Cable	2-6, 8-40, 8-41
EXTERNAL	5-19

**F**

FAR Indicator	1-4
Ferrite core	
Sensor Controller	2-7
Sensor Head	2-5
USB	7-4
FILTER	5-12
FIXED	5-8
FOCUS	
TERMINAL BLOCK	6-13
linear output	6-4
FORWARD	5-15
FUN mode	5-2

**G**

GAIN	5-7
Glass	5-9

**H**

HIGH	
indicator	1-6
OUTPUT	2-10
HI-RESO	5-6
HI-SENS	5-6
HI-SPEED	5-6
HOLD	
DELAY	5-21
TRIGGER	5-19
TYPE	5-18
zero reset types	5-22
HYS	6-7

**I**

I/O circuit diagrams	2-12
IN	6-17
INFO	5-27
INIT	5-29
input signal	6-17
INVERS	5-15

**J**

JUDGE	6-7
-------	-----

**K**

K+mX+nY 5-24  
KEEP 6-15  
KEYLOCK 5-27

**L**

LANGUAG 5-28  
LASER 5-8  
laser emitter/receiver section 1-4  
laser indicator 1-5  
LCD 5-26  
LCD screen  
    CUSTOM 5-26  
    name 5-2  
LD ON 1-5  
LINE 5-7  
line beam width 8-19  
LOW  
    indicator 1-6  
    OUTPUT 2-10

**M**

main display 5-2  
MEASURE 5-24  
measured value display 4-2  
Measuring Range 2-3, 8-2, 8-4, 8-5, 8-6  
MIRROR 5-9  
mode 5-6, 5-7  
mode switch 1-7  
Multi-Task 5-5  
Multi-Task mode 5-4  
mutual interference 8-14  
mutual interference prevention 5-11

**N**

NEAR Indicator 1-4  
NON-MEAS 6-15

**O**

OBJECT 5-9  
OFF 5-18  
OFFSET  
    SCALING 5-17  
    zero reset 5-22  
ON DELAY 6-8  
OUT0 to 4 2-10  
OUTPUT  
    judgment output 6-8  
    linear output 6-3  
    TERMINAL BLOCK 6-10

**P**

panel mount adapter 8-39  
PASS  
    indicator 1-6  
    OUTPUT 2-10  
PCB 5-9  
PEAK  
    hold types 5-18  
    MEASURE 5-24  
P-P 5-18

**R**

RANGE 5-8  
received light amount display 4-2  
receiver section 1-4  
REGULAR 5-8  
resolution display 4-2  
RS-232C  
    cable external dimensions 8-43  
    cable wiring 7-5, 7-6  
    communication settings 7-6  
    connector 1-6  
RUN mode 4-2

**S**

SAMPLE 5-19  
SAVE 5-29  
saving 5-29  
SCALING 5-15  
SELF-DOWN 5-20  
SELF-UP 5-19  
SenINFO 5-28  
SENSING 5-6  
Sensor Controller  
    external dimensions 8-38  
    Installation 2-7  
    part names 1-5  
    specifications 8-36  
    status indicators 8-37  
Sensor Head  
    Adjusting the installation position 2-4  
    Connection 2-5  
    connector 1-6  
    external dimensions 8-7  
    Measuring Range 2-3, 8-2, 8-4, 8-5, 8-6  
    part names 1-4  
    specifications 8-2  
SETTING 5-8  
Single-Task mode 5-4  
SKIP 5-7



SmartMonitor ZS			
installing	2-15		
Start-up and exiting	2-19		
uninstalling	2-15		
SMOOTH	5-12		
SPAN	5-17		
spot diameter	8-18		
STATUS	5-22		
STEP	5-24		
sub-display	4-2, 5-2		
system	5-27		
system configuration	1-3		
<b>T</b>			
task			
selecting	5-5		
switching	5-5		
TEACH Mode	4-7		
TEACHING	4-7		
terminal block			
judgment result display	4-2		
measured value display	4-2		
THICK	5-10, 5-24		
Threshold Selector Switch	1-6		
threshold value display	4-2		
TIMER	6-7		
timing A, B	5-11		
timing charts			
AVERAGE HOLD	6-21		
bank switching	6-22		
basic operation	6-18		
BOTTOM HOLD	6-21		
laser OFF	6-22		
NORMAL	6-19		
PEAK HOLD	6-21		
P-P HOLD	6-21		
RS-232C	7-8		
sample hold	6-20		
terminal block output	6-24, 6-26		
USB	7-8		
zero reset	6-23		
TRIGGER	5-19		
<b>U</b>			
USB			
communication settings	7-4		
driver	2-16		
port	1-6		
<b>V</b>			
VERSION	5-27		
voltage display	4-2		
Voltage/Current switch	1-6		
<b>Z</b>			
zero	1-5		
zero reset	4-5, 5-22		
indicator	1-5		
OFFSET	5-22		
STATUS	5-22		
TYPE	5-22		

MEMO

## Upgrade Information

This section explains the information of version upgrade.

Ver.	Revised contents
Ver.1.100	Enable to connect with Real-time parallel Output unit ZG-RPD. ZG-RPD enables parallel output to a PLC.

## Revision History

A manual revision code appears as a suffix to the catalog number at the bottom of the front and back covers of this manual.

Cat. No. Z236-E1-08

↑  
Revision code

Revision code	Date	Revised contents
01	2005, Nov.	Original production
02	2007, Jan.	<p><b>Page 1-3:</b> Changed note 2.</p> <p><b>Page 1-4:</b> Reversed location of callouts for receiver and emitter sections.</p> <p><b>Page 6-17:</b> Added "CHECK" in middle of page.</p> <p><b>Page 7-6:</b> Added note in middle of page.</p> <p><b>Pages 8-3 to 8-6:</b> Added "typical example"</p> <p><b>Pages 8-7 to 8-9, 8-12, 8-13, and 8-40:</b> Added cable length.</p> <p><b>Page 8-19:</b> Changed measurement center value in five locations.</p> <p><b>Page 8-29 to 8-37:</b> Changed "high-resolution" to "standard"</p> <p><b>Page 8-29:</b> Changed scale in top four charts.</p> <p><b>Page 8-39:</b> Added section on export and trade control ordinances.</p> <p><b>Page 8-45:</b> Changed two notes.</p> <p><b>Page 9-10:</b> Corrected Class 3R cell for eye protection.</p>
02A	2007, Jul.	<b>Page 8-3:</b> Changed table for Note 2.
03	2008, Mar.	<ul style="list-style-type: none"> <li>• Added Sensor Head ZS-HLDS2VT information.</li> <li>• Deleted NS SmartMonitor information.</li> <li>• Minor corrections made.</li> </ul>
03A	2012, Mar.	Additions for Notice for Korea Radio Law
04	2014, Aug	<ul style="list-style-type: none"> <li>• Added Real-time parallel Output unit ZG-RPD information. (Connectable from Ver.1.100)</li> <li>• Added Sensor Head ZS-HLDS32 information.</li> <li>• Minor corrections made.</li> </ul>
05	2015, Aug	• Additions corresponding to change of EN standard.
06	2016, April	• Deleted ZS-HLDS2V Sensor Head long distance extension function
07	2018, April	• SmartMonitor ZS3 corresponds to Windows 10.
08	2019, Oct.	<ul style="list-style-type: none"> <li>• Changed in light source wavelength of ZS-HLDS60 and ZS-HLDS150.</li> <li>• Deleted ZS-HLDS2T and ZS-HLDS32T accompanying discontinued production.</li> <li>• Changed laser equipment standards.</li> </ul>



**OMRON Corporation Industrial Automation Company**

Kyoto, JAPAN

Contact: [www.ia.omron.com](http://www.ia.omron.com)

*Regional Headquarters*

**OMRON EUROPE B.V.**

**Sensor Business Unit**

Carl-Benz-Str. 4, D-71154 Nufringen, Germany  
Tel: (49) 7032-811-0/Fax: (49) 7032-811-199

**OMRON ELECTRONICS LLC**

2895 Greenspoint Parkway, Suite 200  
Hoffman Estates, IL 60169 U.S.A.  
Tel: (1) 847-843-7900/Fax: (1) 847-843-7787

**OMRON ASIA PACIFIC PTE. LTD.**

No. 438A Alexandra Road # 05-05/08 (Lobby 2),  
Alexandra Technopark,  
Singapore 119967  
Tel: (65) 6835-3011/Fax: (65) 6835-2711

**OMRON (CHINA) CO., LTD.**

Room 2211, Bank of China Tower,  
200 Yin Cheng Zhong Road,  
PuDong New Area, Shanghai, 200120, China  
Tel: (86) 21-5037-2222/Fax: (86) 21-5037-2200

**Authorized Distributor:**

© OMRON Corporation 2005-2019. All Rights Reserved.  
In the interest of product improvement,  
specifications are subject to change without notice.

**Cat. No. Z236-E1-08**

1019